

**100<sup>TH</sup>**  
ANNIVERSARY  
1919 - 2019

**GEDORE**  
TOOLS FOR LIFE

# ENTIRE RANGE

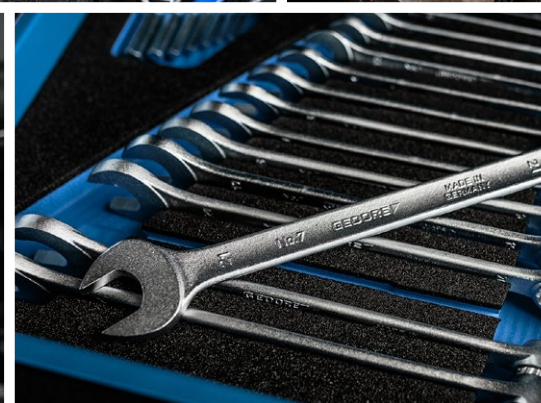
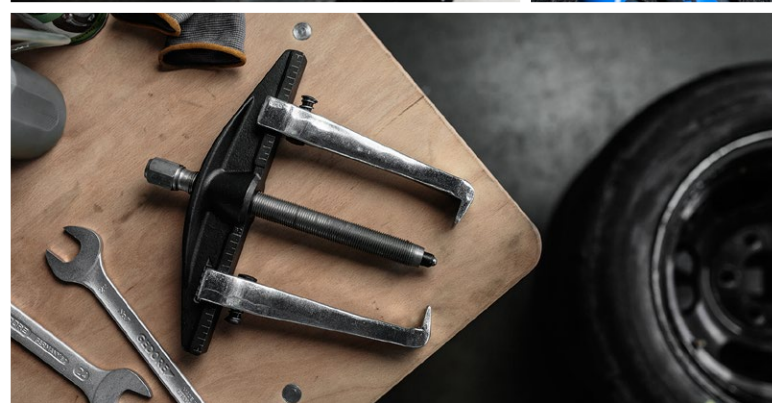
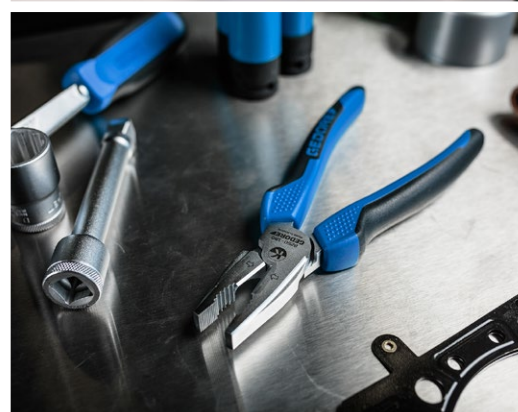

2019





# Constant innovation.

We won't remain good if we don't strive to be constantly better.

Remaining true to this claim we have come up with a fresh presentation for bundling our skills: The strength of the entire company group is fused into one powerful brand – GEDORE.

Along with the tried-and-tested portfolio, this catalogue has numerous new product ideas. They again reveal how successful a connection is – the innovation potential of which is built on the sound foundation of a lengthy track record and second-to-none manufacturer competence.

For practically 100 years now, our customer have placed maximum demands on our products as regards material, design, processing, precision, strength and durability. And these requirements continue to define and determine our standards

in realising our vision: One of people across the world working more safely and productively – with GEDORE tools.

As no other brand can do, GEDORE stands for maximum quality, local presence, technical competence and reliability. A good enough reason for you to continue to put your trust in us as the reliable partner at your side – when it's a matter of using the best possible tools to excellently master the most complex of tasks.

**Our word in your hands.  
GEDORE – Tools for life.**

---

# CONTENTS

---

## WORKSHOP EQUIPMENT

Workshop Equipment	010
Mobile Tool Storage	046
Tool Assortments	064

---

## GENERAL HAND TOOLS

Spanners	116
Sockets and Accessories	152
Torque Tools	258
Torque Multipliers	328
Screwdrivers	342
Pliers	364
Pullers	426
Hammers / Striking Tools	496
Workshop Supplies	532

---

## OCCUPATIONAL TOOLS

VDE Insulated Safety Tools	568
Installation Tools	596
Bending Systems	612

---

## TECHNOLOGY AND SAFETY

Service information DAkkS	636
Safety information	639
Technical information	643

---

## SERVICE

Index	655
Disclaimer	674
Contacts	675



## › 205

1993 U-20  
REVERSIBLE RATCHET 1/2



## › 054

GEDORE SORTIMO®  
MOBILITY IN  
PERFECTION



TORQUE TOOLS  
UNCOMPROMISING  
AMBITION

Controlled screw tightening - reliable  
and safe for more than 50 years

**> 258**

**> 020**

WSL-L  
WORKSTER SMARTLINE



8133  
MULTIPLE PLIERS

**> 378**



7R  
COMBINATION  
RATCHET SPANNER

**> 123**



8573 BC - 8578 BCL  
TORQUE WRENCH  
DREMOMETER

**> 273**





## Future-oriented intelligence.

Innovation stands for renewal. However, new ideas and refinements can only develop their potential when meaningfully applied and when they create actual value added. It is only then that they set standards for the future.

We have continued to set these standards based, as they are, on intelligent solutions and trail-blazing product innovations. We are continuously working to develop needs-based tools with which our customers throughout the world can work even more safely and productively. This is our vision and drive behind it to constantly deliver maximum performance.

We have been regularly distinguished for our products' innovativeness and quality. This was the case, for instance, in 2015 with the Red Dot Award and the competence prize for innovation and quality

of the Federal state of Baden-Württemberg as well as with the Eisen Award in 2012 and 2014.

This fills us with pride and equally gives us the assurance that these successes not only generate meaningful value added for ourselves but also, in particular, for our customers.

The fact that we remain true to our ideals is shown in this catalogue providing new, innovative GEDORE premium products. They include the workster workshop trolley, E-Torc Q, and the digital torque analysis wrench from GEDORE TorqueTech.

**We are moving ahead. Come and join us.**





## Local presence that delights.

With some 2,700 employees the GEDORE Group is represented in more than 70 countries worldwide. Aside from our seven production sites in Germany, we also manufacture in Austria, Great Britain, South Africa and Brazil. An international dealer network sees to the sales of our tools. In this way we ensure the best-possible presence for our customers, contact to qualified contact persons as well as short paths and rapid delivery times.

But in matters of local presence we understand more than just that. After all, it is your individual requirements which we focus on. That is why we provide you with a comprehensive service package in terms of maintenance and upkeep. Torque tools, for instance, can be calibrated in our certificated laboratory to ensure their sustained precision. The above-mentioned sustained alignment of our assortment as well as our data management services

and individual training offers for your employees all create planning reliability.

At the same time we are enthusiastic about developing and constructing tailored solutions and needs-based non-standard designs. Your requests – however special they may be – motivate us in providing you here with maximum individual quality and the associated safety-at-work.

**Test us out. Wherever and whenever.**

# Uncompromisingly to a high grade and quality.

We are one of the world's quality leaders in professional tools, workshop furnishings and non-standard solutions for industry, the trades, automotive/utility vehicles and renewable energies, amongst others. Without a doubt, this ranks the GEDORE Group amongst the leading manufacturers on the European market.

Quality is bound up with obligations – something we take seriously and consistently orientate ourselves to. This begins with selecting first-rate materials with which to manufacture our products. The extensive track record of our skilled staff and use of modern, efficient production processes have allowed us to manufacture that premium tool from high-grade material - one which has been synonymous with the GEDORE name for almost 100 years.

When manufacturing our innovative products we rely above all on proven expertise. A great many of our goods are made in a forging process, mostly drop-forging. The result is outstanding quality in terms of robustness, toughness and dimensional stability. It is not without reason that we operate one of the world's largest hydraulic double-acting hammers, which other suppliers greatly appreciate who have their forged parts made by us.

In addition, maximum ergonomics, functionality and precision are very much features of our products. The prime example for a profitable association of all these features is the ALU DREMOMETER – as ever the absolute ultimate in mechanical torque technology.

We see conscientious compliance with quality standards not only as a must, but also as an incentive to go that one step further. In many cases, our tools exceed DIN requirements. Our production processes are continually subjected to examination and auditing. We are certified in accordance with DIN ISO 9001 standards and our calibration laboratories have passed DAkkS auditing as well as other standards.

As a manufacturer we place our faith in a sustained assortment configuration. As such, we create a high degree of investment and planning reliability for you – another reason, in fact, to trust in us.

**We do our best.  
Without any reservations attached.**









GEDORE

GEDORE 1504 XL





# WORKSHOP EQUIPMENT

## TOOL TROLLEYS

>016



## ACCESSORIES

TOOL TROLLEYS

>025



## WORKBENCHES

>026



## ACCESSORIES

WORKBENCHES

>034



## FOLDING

WORKBENCH

>034



## USEFUL HELPERS FOR

TOOL TROLLEYS/  
WORKBENCHES

>035



## TOOL CABINETS

>036



## TOOL HOLDERS/ TOOL HOOKS

>037

>037



## WORKMO

>042





# GEDORE WORKSHOP FURNITURE

Intelligently designed - dependable under extreme use



## Best-possible quality for the highest demands placed

- › Use of the most up-to-date machinery and environmentally-friendly production processes
- › The basis is tightly-controlled and choice sheet steel
- › Experienced and reliable specialists vouch for precision-like processing
- › Stringent quality checks after each production step ensure a constantly high level
- › Best-possible industrial quality for those extreme levels of constant use and conditions subjected to
- › Professional service up to the development of special customised tools
- › Vertical and horizontal forces are calculated with precision
- › Unloaded weight optimisation from a finely-tuned material input
- › Robust, stable 0.88 mm thick sheet steel structure, supporting elements of a 1.00 mm metal thickness, a 2.00 mm metal thickness for the heavy-duty chassis
- › Precision spot welding ensures components stay permanently fixed
- › Tool trolleys have it all with their special GEDORE chassis and GEDORE heavy-duty wheels
- › Durable and highly resilient with stability of the highest-order

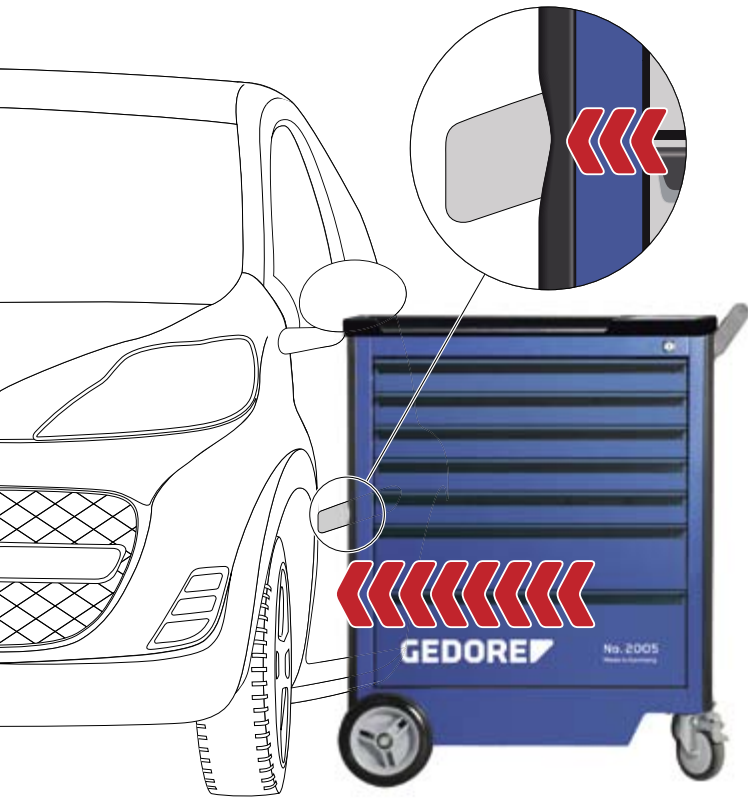

## Form and function perfection

- > Whether mobile or stationary: indispensable aids, in fact, for the rough-and-ready of workshop routine
- > Extremely robust, scratch and impact-resistant, corrosion-proof and easy to care for
- > Durable and highly resilient with stability of the highest-order
- > Numerous models to reflect use and individual requirements
- > Varied, optional accessories available for flexibly extending all the basic models
- > Specific colours (RAL) and outfits on request

## GEDORE INDIVIDUAL PRECISE - CUSTOMISED

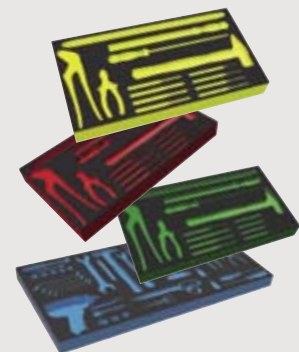

Tidy look, uncluttered and always at hand

- > Ready to be used straight after delivery: simply unpack and screw on the manoeuvring handle
- > Whether a mobile or stationary guardian of tidiness: each tool has its own place here
- > Modular arrangement systems make daily routine that much easier (visual check/tool missing)
- > Compact tool assortments make selection easier
- > Customised equipment/tool sets in module systems and/or trolleys/benches in company design/colours

Why not create your perfection in tool orderliness in line with corporate design requests and your process specifications - We look forward to hearing from you!



# THE GEDORE TROLLEY



## Load capacity

- > The load capacity of the drawers is 40 kg
- > Models 2004\*, 2005, 1502, 1504\*, 1504.XL, 1506 XL: The bottom drawer is designed as heavy-duty drawer, load capacity 60 kg
- > \* apart from 2004 1000, 1504 1000

## Ball-bearing drawer slides

- > The ball-bearing drawer slides ensure safe and easy sliding of the drawers, even when loaded to full capacity



## Individual drawer locking

- > In addition to the central locking, each drawer has its own separate latch to prevent unwanted opening, when being moved
- > The latch is automatically released by a tilting bar when the drawer is opened
- > The single latch automatically engages when the drawer closes
- > When marked with "E" the drawers are delivered with individual drawer blocking



## Central locking

- > One central lock for all drawers and doors
- > Safe and easy handling



## Square perforation 10 x 38 mm

- > The square perforation in the side walls enable quick access to frequently used tools
- > GEDORE holders and trays are simply clipped in

## Smooth running wheel

- > Precision ball bearing

## Heel protection

- > All-round heel protection by rounded edges on the underside allows the tool trolley or workbench to be safely pulled or pushed

## Powder coating

- > This coating method guarantees a high level of corrosion protection, combined with tough scratch resistance
- > Special colours available on request

## High-performance wheel

- > High load capacity
- > Tyres made from solid rubber
- > Roller bearing
- > Resistant to abrasion

## Impact protection

- > The vertical impact protection protects the tool trolley and anything it comes into contact with from damage
- > It also protects other equipment in the workshop or vehicles from inadvertent contact

## Total brake

- > Prevents unwanted movement and turning of the wheel
- > Ensures safe parking of the tool trolley or workbench





# Tool Trolleys

## 2005 TOOL TROLLEY

**Body:**

- > Dimensions: H 985 x W 775 x D 475 mm
- > Working platform in ABS, with 3 compartments for small parts
- > With handle for easy pushing, pulling and turning
- > Side walls with Euro perforation 10 x 38 mm to fix hooks and tools
- > Heel and impact protection for your safety
- > Sheet steel, corrosion resistant and scratch-proof powder-coated, GEDORE blue

**Drawers:**

- > Central locking with cylinder lock
- > Wide drawers (W 640 x D 400 mm) fully extendable, removable
- > Each drawer with safety locking, single-hand operation
- > Ball-bearing guide rails
- > Can be individually equipped with lengthwise and crosswise dividers (can be ordered individually)
- > Load capacity per drawer 40 kg, bottom heavy-duty drawer 60 kg
- > Sheet steel, corrosion resistant and scratch-proof powder-coated, GEDORE blue

**GEDORE High-performance chassis:**

- > Total load capacity 500 kg
- > 2 high-performance wheels on roller bearings (fixed castors Ø 200 mm)
- > 2 smooth running wheels on ball bearings (swivel castors Ø 125 mm), both with total brake
- > The GEDORE axle construction secures smooth running, manoeuvrability and track-keeping also in case of maximum loads

**Accessories:**

- > Length- (LD) and crosswise (CD) dividers from zinc-plated sheet steel

**Options:**

- > Can be equipped with GEDORE tool modules (1500 ES/1500 CT or 2005 CT)
- > Optionally extendable with GEDORE tool chests, rear panels and tool holders
- > Further drawer combinations on request
- > Special colours and designs available on request
- > Delivery without tools and accessories



2005 0511

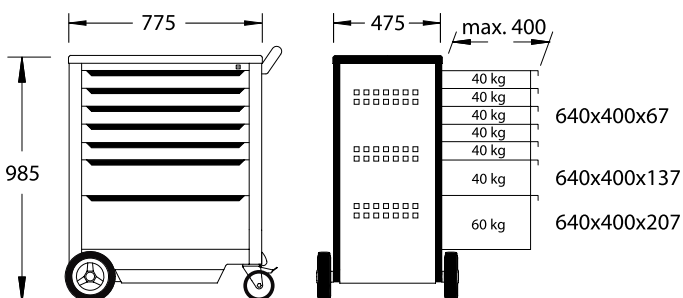



## 2005 VARIANTS



No.	2005 0511	2005 0511 E	2005 0321
	7 drawers: 5x type 1, H = 67 mm 1x type 2, H = 137 mm 1x type 3, H = 207 mm	7 drawers: 5x type 1, H = 67 mm 1x type 2, H = 137 mm 1x type 3, H = 207 mm	6 drawers: 3x type 1, H = 67 mm 2x type 2, H = 137 mm 1x type 3, H = 207 mm
H	985	985	985
W	775	775	775
D	475	475	475
LD	10x	10x	6x
CD	2x	2x	2x
	93.0	93.0	89.0
Code	1803018	2827379	2003546



No.	2005 0701	2005 0810
	8 drawers: 7x type 1, H = 67 mm 1x type 3, H = 207 mm	9 drawers: 8x type 1, H = 67 mm 1x type 2, H = 137 mm
H	985	985
W	775	775
D	475	475
LD	10x	15x
CD	2x	3x
	92.0	99.0
Code	2003554	2003562

2430

»24



R 2004 L

»25



RT 2004 L

»25

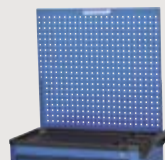
SL 2013 / SL 3014 / SL 1912 /  
SL 1916

»175/191/218





# 2004 TOOL TROLLEY

**Body:**

- > Dimensions: H 985 x W 775 x D 475 mm
- > Working platform in ABS, with 3 compartments for small parts
- > Storage compartment with perforated sheet (Euro perforation 10 x 38 mm), two removable drawers for small parts and door on the handle side
- > With handle for easy pushing, pulling and turning
- > Front side with Euro perforation 10 x 38 mm to fix hooks and tools
- > Heel and impact protection for your safety
- > Sheet steel, corrosion resistant and scratch-proof powder-coated, GEDORE blue

**Drawers:**

- > Central locking with cylinder lock
- > Wide drawers (W 480 x D 400 mm) fully extendable, removable
- > Each drawer and storage compartment with safety locking, single-hand operation
- > Ball-bearing guide rails
- > Can be individually equipped with lengthwise and crosswise dividers (can be ordered individually)
- > Load capacity per drawer 40 kg, bottom heavy-duty drawer 60 kg (apart from 2004 1000)
- > Sheet steel, corrosion resistant and scratch-proof powder-coated, GEDORE blue

**GEDORE High-performance chassis:**

- > Total load capacity 500 kg
- > 2 high-performance wheels on roller bearings (fixed castors Ø 200 mm)
- > 2 smooth running wheels on ball bearings (swivel castors Ø 100 mm), both with total brake
- > The GEDORE axle construction secures smooth running, manoeuvrability and track-keeping also in case of maximum loads

**Accessories:**

- > Length- (LD) and crosswise (CD) dividers from zinc-plated sheet steel

**Options:**

- > Can be equipped with GEDORE tool modules (1500 ES/1500 CT)
- > Optionally extendable with GEDORE tool chests, rear panels and tool holders
- > Further drawer combinations on request
- > Special colours and designs available on request
- > Delivery without tools and accessories



2004 0131

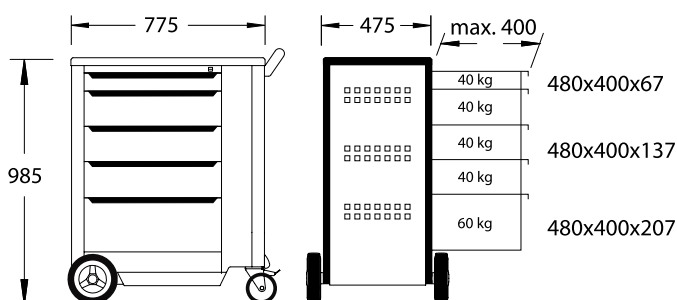

2004 0321

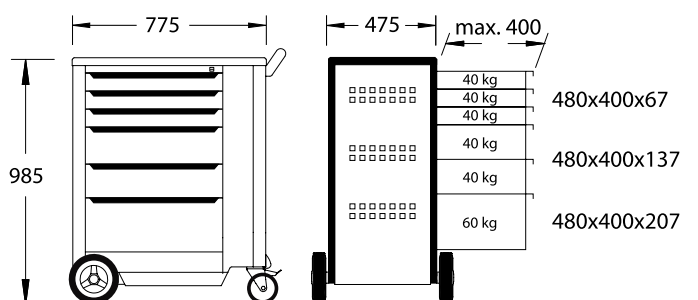



# 2004 VARIANTS



No.	2004 0131	2004 0321	2004 0511	2004 0511 E
	5 drawers: 1x type 1, H = 67 mm 3x type 2, H = 137 mm 1x type 3, H = 207 mm	6 drawers: 3x type 1, H = 67 mm 2x type 2, H = 137 mm 1x type 3, H = 207 mm	7 drawers: 5x type 1, H = 67 mm 1x type 2, H = 137 mm 1x type 3, H = 207 mm	7 drawers: 5x type 1, H = 67 mm 1x type 2, H = 137 mm 1x type 3, H = 207 mm
H	985	985	985	985
W	775	775	775	775
D	475	475	475	475
LD	3x	6x	10x	10x
CD	2x	2x	2x	2x
	75.0	82.0	84.0	84.0
Code	1640763	1640755	1640739	2827360



No.	2004 0701	2004 0620	2004 0810	2004 1000
	8 drawers: 7x type 1, H = 67 mm 1x type 3, H = 207 mm	8 drawers: 6x type 1, H = 67 mm 2x type 2, H = 137 mm	9 drawers: 8x type 1, H = 67 mm 1x type 2, H = 137 mm	10 drawers: 10x type 1, H = 67 mm
H	985	985	985	985
W	775	775	775	775
D	475	475	475	475
LD	10x	10x	15x	15x
CD	2x	2x	3x	3x
	86.0	88.0	91.0	94.0
Code	1640712	1640720	1640704	1640690

2004 0511

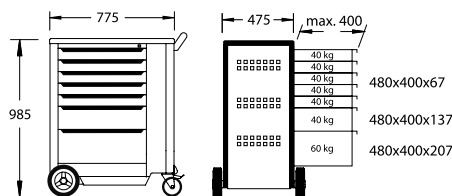

2004 0620

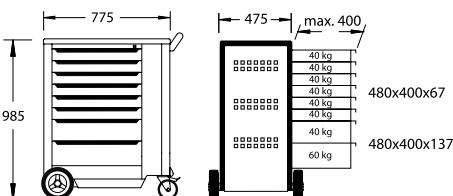

2004 0701

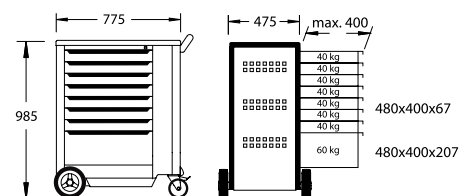

2004 0810

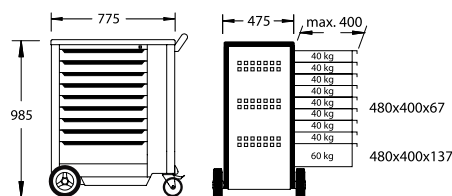

2004 1000

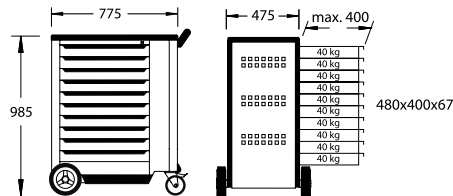

# WSL-L7

## TOOL TROLLEY WORKSTER SMARTLINE

with 7 drawers

**Body:**

- > Dimensions: H 1045 x W 785 x D 510 mm
- > Working platform with PP top with front flattening, anti-roll safety edge and small additional trays
- > With handle for easy pushing, pulling and turning
- > Side walls with Euro perforation 10 x 38 mm to fix hooks and tools
- > Sides rounded off – a minimum of abutting edges
- > Welded sheet steel construction, torsionally rigid, to take high loadings
- > Sheet steel, corrosion resistant and scratch-proof powder-coated

**Drawers:**

- > **Individual blocking** only one drawer can be open at a time, single-hand operation
- > Central locking with cylinder lock
- > 7 wide drawers (W 640 x D 400 mm) fully extendable
- > Ball-bearing guide rails
- > Load capacity per drawer 20 kg
- > Sheet steel, corrosion resistant and scratch-proof powder-coated

**GEDORE Chassis**

- > Total load capacity 400 kg
- > 4 smooth running wheels on ball bearings (swivel castors Ø 125 mm), one with total brake
- > Even with maximum loads: still smooth running, manoeuvrable and keeps to the track

**Options:**

- > Can be equipped with GEDORE tool modules (1500 ES, 1500 CT, 2005 CT, TS-147, TS-190, TS-308)
- > Can be individually equipped with lengthwise and crosswise dividers
- > Special colours and designs available on request
- > Delivery without tools and accessories



	H	W	D	⚖️	Code	No.
7 drawers:	1045	785	510	81.0	2977311	WSL-L7
5x type 1, H = 80 mm						
2x type 2, H = 162.5 mm						





# 2525-520 TOOL TROLLEY

with 7 drawers

**Body:**

- > Dimensions: H 965 x W 720 x D 395 mm
- > Working platform in ABS, with 3 compartments for small parts
- > Storage compartment with perforated sheet (square perforation 10 x 38 mm) on the handle side
- > With handle for easy pushing, pulling and turning
- > 1 side wall with Euro perforation 10 x 38 mm to fix hooks and tools
- > All-round heel and impact protection for your safety
- > Sheet steel, corrosion resistant and scratch-proof powder-coated, GEDORE blue

**Drawers:**

- > Central locking with cylinder lock
- > 5 wide drawers (W 480 x D 325 x H 75 mm) fully extendable
- > 2 large capacity drawers (W 480 x D 325 x H 120 mm) fully extendable, for bulky parts
- > Individual drawer locking, single-hand operation
- > Ball-bearing guide rails
- > Can be individually equipped with lengthwise and crosswise dividers (can be ordered individually, not for the large capacity drawers)
- > Load capacity per drawer 40 kg
- > Sheet steel, corrosion resistant and scratch-proof powder-coated, GEDORE blue

**GEDORE High-performance chassis:**

- > Total load capacity 330 kg
- > 2 high-performance wheels on roller bearings (fixed castors Ø 140 mm)
- > 2 smooth running wheels on ball bearings (swivel castors Ø 100 mm), one with total brake
- > The GEDORE trapezoidal axle construction secures smooth running, manoeuvrability and track-keeping also in case of maximum loads

**Accessories:**

- > 10-piece hook assortment
- > 8 length- (LD) and 2 crosswise (CD) dividers from zinc-plated sheet steel

**Options:**

- > Can be equipped with GEDORE tool modules (1500 ES/1500 CT)
- > Special colours and designs available on request
- > Delivery without tools and accessories

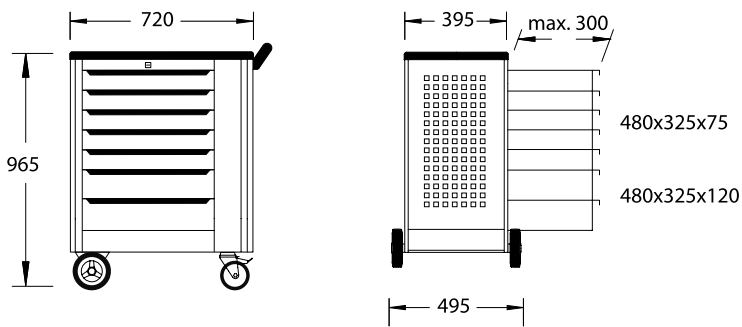

H	W	D	LD	CD		Code	No.
965	720	395	8x	2x	67.0	1587102	2525-520

# 1580 TOOL TROLLEY

with 4 drawers

**Body:**

- > Dimensions: H 930 x W 625 x D 400 mm
- > Double sided metal shutters to secure the whole internal space
- > Working platform with ABS top
- > With handle for easy pushing, pulling and turning
- > Side walls with Euro perforation 10 x 38 mm to fix hooks and tools
- > All-round heel and impact protection for your safety
- > Sheet steel, corrosion resistant and scratch-proof powder-coated, GEDORE blue

**Drawers:**

- > Central locking with cylinder lock
- > 4 wide drawers (W 480 x D 325 x H 45 mm), all drawers open either side
- > 1 deep storage at base
- > Ball-bearing guide rails, with middle and end catches
- > Can be individually equipped with lengthwise and crosswise dividers (can be ordered individually)
- > Load capacity per drawer 20 kg
- > Sheet steel, corrosion resistant and scratch-proof powder-coated, GEDORE blue

**GEDORE Chassis**

- > Total load capacity 300 kg
- > 2 high-performance wheels on roller bearings (fixed castors Ø 140 mm)
- > 2 smooth running wheels on ball bearings (swivel castors Ø 100 mm), one with total brake
- > The GEDORE trapezoidal axle construction secures smooth running, manoeuvrability and track-keeping also in case of maximum loads

**Accessories:**

- > 8 length- (LD) and 2 crosswise (CD) dividers from zinc-plated sheet steel

**Options:**

- > Can be equipped with GEDORE tool modules (1500 ES/1500 CT)
- > Optionally extendable with GEDORE tool chest 1430
- > Special colours and designs available on request
- > Delivery without tools and accessories

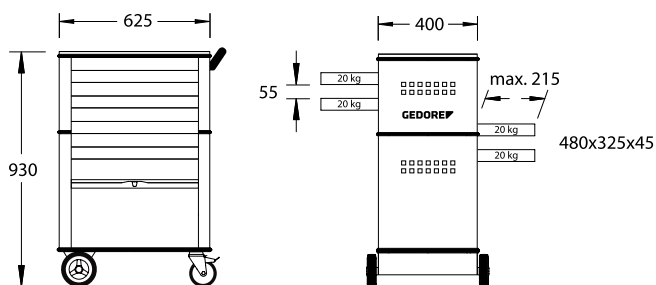

H	W	D	LD	CD		Code	No.
930	625	400	8x	2x	40.0	6627550	1580



# 1578 TOOL TROLLEY

with 6 drawers

**Body:**

- > Dimensions: H 930 x W 605 x D 375 mm
- > Working platform in ABS, with 3 compartments for small parts
- > With handle for easy pushing, pulling and turning
- > Heel protection for your safety
- > Sheet steel, corrosion resistant and scratch-proof powder-coated, GEDORE blue

**Drawers:**

- > Central locking with cylinder lock
- > 4 wide drawers (W 480 x D 325 x H 75 mm)
- > 1 wide drawer (W 480 x D 325 x H 120 mm)
- > 1 wide drawer (W 480 x D 325 x H 210 mm)
- > All drawers open either side
- > Can be individually equipped with lengthwise and crosswise dividers (can be ordered individually)
- > Load capacity per drawer 20 kg
- > Sheet steel, corrosion resistant and scratch-proof powder-coated, GEDORE blue

**GEDORE Chassis**

- > Total load capacity 200 kg
- > 2 high-performance wheels on roller bearings (fixed castors Ø 140 mm)
- > 2 smooth running wheels on ball bearings (swivel castors Ø 100 mm), one with total brake
- > The GEDORE trapezoidal axle construction secures smooth running, manoeuvrability and track-keeping also in case of maximum loads

**Accessories:**

- > 6 length- (LD) and 2 crosswise (CD) dividers from zinc-plated sheet steel

**Options:**

- > Can be equipped with GEDORE tool modules (1500 ES/1500 CT)
- > Special colours and designs available on request
- > Delivery without tools and accessories

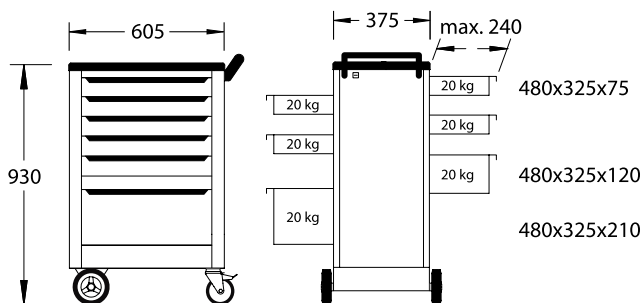

H	W	D	LD	CD		Code	No.
930	605	375	6x	2x	43.5	9018140	1578



## Top Tool Chests

Suitable for all GEDORE tool trolleys with a work surface of W 625 x D 400 mm  
 Drawers fully extendable  
 Supplied with length- and crosswise dividers  
 Delivery without tools

### 1430 TOOL CHEST

> Designed particularly as top box for trolley 1580

**Body:**

- > Dimensions: H 305 x W 625 x D 400 mm
- > ABS top
- > Heel and impact protection for your safety
- > Sheet steel, corrosion resistant and scratch-proof powder-coated, GEDORE blue

**Drawers:**

- > Central locking with cylinder lock
- > 3 wide drawers (W 480 x D 325 mm) fully extendable, removable
- > Each drawer with safety locking, single-hand operation
- > Ball-bearing guide rails
- > Can be individually equipped with lengthwise and crosswise dividers (can be ordered individually)
- > Load capacity per drawer 40 kg
- > Sheet steel, corrosion resistant and scratch-proof powder-coated, GEDORE blue

**Accessories:**

- > 6 length- (LD) and 2 crosswise dividers (CD) in zinc-plated sheet steel

**Options:**

- > Can be equipped with GEDORE tool modules (1500 ES/1500 CT)
- > Special colours and designs available on request
- > Delivery without tools and accessories



### 2430 TOOL CHEST

**Body:**

- > Dimensions: H 345 x W 775 x D 475 mm
- > Working platform in ABS with 3 compartments for small parts
- > Sheet steel, corrosion resistant and scratch-proof powder-coated, GEDORE blue

**Drawers:**

- > Central locking with cylinder lock
- > Wide drawers (W 640 x D 400 x H 67 mm) fully extendable, removable
- > Each drawer with safety locking, single-hand operation
- > Ball-bearing guide rails
- > Can be individually equipped with lengthwise and crosswise dividers (can be ordered individually)
- > Load capacity per drawer 40 kg
- > Sheet steel, corrosion- and scratch-resistant powder-coated, GEDORE blue

**Use:**

- > Designed particularly as top box for trolleys 2004, 2005

**Accessories:**

- > 6 length- (LD) and 2 crosswise dividers (CD) in zinc-plated sheet steel

**Options:**

- > Can be equipped with GEDORE tool modules (1500 ES/1500 CT)
- > Safe locking drawers on request

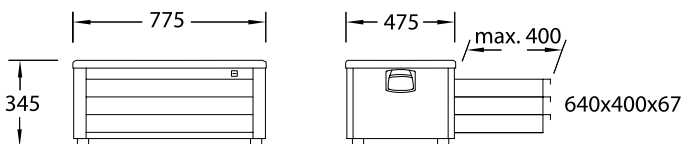
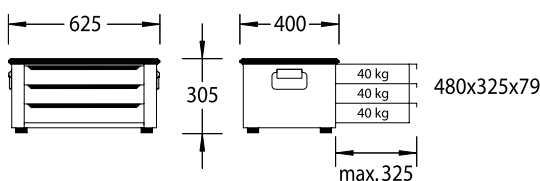
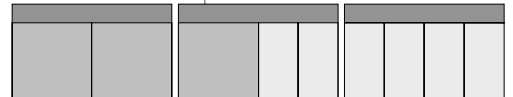

H	W	D	LD	CD		Code	No.
305	625	400	6x	2x	26.0	6618130	1430

H	W	D	LD	CD		Code	No.
345	775	475	6x	2x	34.0	1888927	2430



## Accessories Tool Trolleys

### 2004 HP WOOD PLATE

- > To fit in the plastic top, 30 mm thick, to get an additional work surface
- > Multiplex beech wood
- > For tool trolleys 2004 and 2005 and tool chest 2430
- > No. 2004 HP until 03/2014 for depth 435 mm, no. 2004 HP-14 as from 04/2014, for depth 475 mm



W	D	mm	Execution	kg	Code	No.
590	410	30	until 03/2014	5.0	1446967	2004 HP
563	409	30	as from 04/2014	5.0	2879883	2004 HP-14

### R 2004 L REAR PANEL

- > Automatically raised by two gas springs
- > Neat arrangement of tools on square perforation 10 x 38 mm
- > The complete loaded rear wall can be simply lowered
- > Central locking with cylinder lock
- > Can be attached to 2004, 2005
- > Delivery without tools

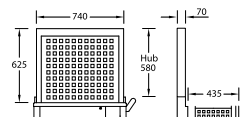

H	W	D	kg	Code	No.
768	770	116	25.0	1446169	R 2004 L

### RT 2004 L REAR PANEL BOARD

- > Square perforation 10 x 38 mm
- > Can be attached to 2004 and 2005 (as well as old models 2002 and 2003)



H	W	D	kg	Code	No.
715	765	30	11.0	2663104	RT 2004 L

### 1500 H 13 ANTI-SLIP MAT

Products sold by the metre

- > For all drawers in GEDORE tool trolleys and workbenches
- > Various areas of application: Workshop, household, car, spare time...
- > Enormous slip resistance on many different surfaces
- > Can be cut to size
- > Resistant to temperatures from -30 °C to +100 °C
- > Melting point approx. +250 °C
- > Flame resistant
- > Resistant to chemicals
- > Shock- and noise absorbing
- > Dimensions: W 475 x L 2000 mm



L m	W	kg	Code	No.
2	475	0.540	5790250	1500 H 13

## Workbenches

# 1505 MOBILE WORKBENCH

### Body:

- > Dimensions: H 900 x W 1100 x D 652 mm
- > 40 mm thick multiplex beech wood worktop, surface additionally protected by linseed oil varnish
- > Large usable storage space with shelf and door
- > Easy, safe movement with pull handle
- > Heel protection for your safety
- > Sheet steel, corrosion resistant and scratch-proof powder-coated, GEDORE blue

### Drawers:

- > Central locking with cylinder lock
- > 5 wide drawers (W 480 x D 550 mm), extendable up to 505 mm, removable
- > Each drawer with safety locking, single-hand operation
- > Ball-bearing guide rails
- > Can be individually equipped with lengthwise and crosswise dividers (can be ordered individually)
- > Load capacity per drawer 40 kg
- > Sheet steel, corrosion resistant and scratch-proof powder-coated, GEDORE blue

### GEDORE Jumbo heavy-duty chassis:

- > Total load capacity 2000 kg, 500 kg when mobile
- > 4 GEDORE wheels on roller bearings with independent wheel suspension
- > Absolutely stable standing when lowered
- > Mobile due to hydraulic raising mechanism, just lift the pull handle
- > High floor clearance

### Accessories:

- > 9 length- (LT) and 9 crosswise (QT) dividers from zinc-plated sheet steel

### Options:

- > Can be equipped with GEDORE tool modules (1500 ES/1500 CT)
- > Rear panel R 1504 L can be added
- > Delivery without tools and accessories
- > Special colours and designs available on request

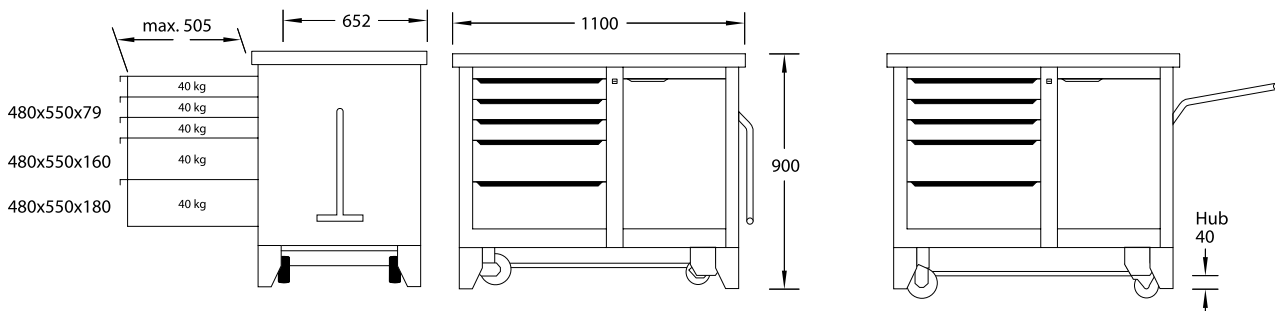

Description	H	W	D	mm	LD	CD	kg	Code	No.
<b>Mobile workbench</b>	900	1100	652	40	9x	9x	138.0	6621780	1505
<b>Mobile workbench with vice</b>	900	1100	652	40	9x	9x	156.5	6621860	1505 S

R 1504 XL-L



>34

411



>554





# 1506 XL

## MOBILE WORKBENCH EXTRA WIDTH

### Body:

- > Dimensions: H 985 x W 1250 x D 550 mm
- > 30 mm thick multiplex beech wood worktop, surface additionally protected by linseed oil varnish
- > With two similar drawer blocks
- > Heel protection for your safety
- > Sheet steel, corrosion resistant and scratch-proof powder-coated, GEDORE blue

### Drawers:

- > Central locking with cylinder lock
- > Wide drawers (W 480 x D 400 mm) fully extendable, removable
- > Each drawer with safety locking, single-hand operation
- > Ball-bearing guide rails
- > Can be individually equipped with lengthwise and crosswise dividers (can be ordered individually)
- > Load capacity per drawer 40 kg, bottom heavy-duty drawers 60 kg
- > Sheet steel, corrosion resistant and scratch-proof powder-coated, GEDORE blue

### GEDORE High-performance chassis:

- > Total load capacity 700 kg, 500 kg when mobile
- > 2 high-performance wheels on roller bearings (fixed castors Ø 200 mm)
- > 2 smooth running wheels on ball bearings (swivel castors Ø 125 mm), both with total brake
- > The GEDORE trapezoidal axle construction secures smooth running, manoeuvrability and track-keeping also in case of maximum loads

### Accessories:

- > 4 distance modules No. 1500 ED-70 K
- > Length- (LT) and crosswise (QT) dividers from zinc-plated sheet steel

### Options:

- > Can be equipped with GEDORE tool modules (1500 ES/1500 CT)
- > Rear panel R 1504 XL-L can be added
- > Further drawer combinations on request
- > Special colours and designs available on request
- > Delivery without tools and accessories



# 1506 XL

## VARIANTS



No.	1506 XL 2511	1506 XL 2810
	14 drawers: 10x type 1, H = 67 mm 2x type 2, H = 137 mm 2x type 3, H = 207 mm	18 drawers: 16x type 1, H = 67 mm 2x type 2, H = 137 mm
H	985	985
W	1250	1250
D	550	550
mm	30	30
LD	15x	15x
CD	3x	3x
	140.0	150.0
Code	2528088	2528096

1506 XL 2511

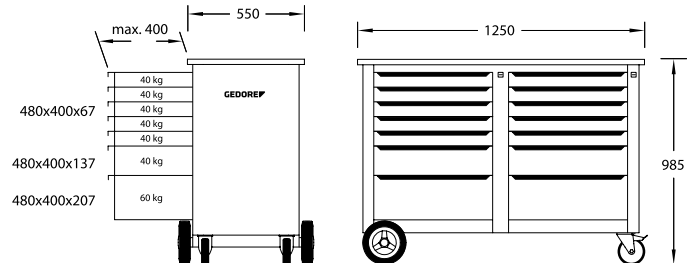

1506 XL 2810

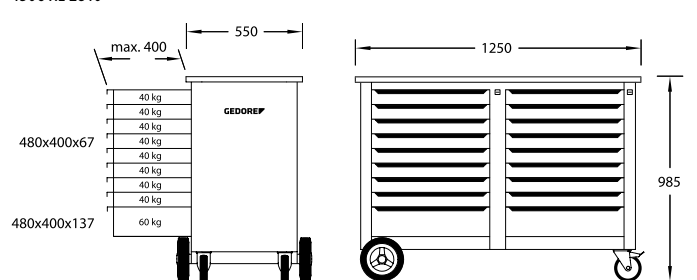

# 1504 MOBILE WORKBENCH

**Body:**

- > Dimensions: H 985 x W 1100 x D 550 mm
- > 30 mm thick multiplex beech wood worktop, surface additionally protected by linseed oil varnish
- > Large storage space with shelf and door
- > Heel protection for your safety
- > Sheet steel, corrosion resistant and scratch-proof powder-coated, GEDORE blue

**Drawers:**

- > Central locking with cylinder lock
- > Wide drawers (W 480 x D 400 mm) fully extendable, removable
- > Each drawer with safety locking, single-hand operation
- > Ball-bearing guide rails
- > Can be individually equipped with lengthwise and crosswise dividers (can be ordered individually)
- > Load capacity per drawer 40 kg, bottom heavy-duty drawer 60 kg (apart from no. 1504 1000)
- > Sheet steel, corrosion resistant and scratch-proof powder-coated, GEDORE blue

**GEDORE High-performance chassis:**

- > Total load capacity 700 kg, 500 kg when mobile
- > 2 high-performance wheels on roller bearings (fixed castors Ø 200 mm)
- > 2 smooth running wheels on ball bearings (swivel castors Ø 125 mm), both with total brake
- > The GEDORE trapezoidal axle construction secures smooth running, manoeuvrability and track-keeping also in case of maximum loads

**Accessories:**

- > 4 distance modules no. 1500 ED-70 K
- > Length- (LT) and crosswise (QT) dividers from zinc-plated sheet steel

**Options:**

- > Can be equipped with GEDORE tool modules (1500 ES/1500 CT)
- > Rear panel no. R 1504 L or RT 1504 L can be added
- > Further drawer combinations on request
- > Special colours and designs available on request
- > Delivery without tools and accessories

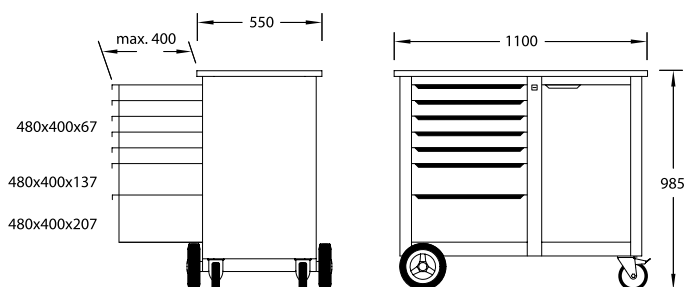



# 1504 VARIANTS



Code	6622830	6623050	1814958
	7 drawers: 5x type 1, H = 67 mm 1x type 2, H = 137 mm 1x type 3, H = 207 mm	7 drawers: 5x type 1, H = 67 mm 1x type 2, H = 137 mm 1x type 3, H = 207 mm	6 drawers: 3x type 1, H = 67 mm 2x type 2, H = 137 mm 1x type 3, H = 207 mm
Description	Mobile workbench with 7 drawers	Mobile workbench with 7 drawers and vice	Mobile workbench with 6 drawers
H	985	985	985
W	1100	1100	1100
D	550	550	550
LD	10x	10x	6x
CD	2x	2x	2x
	103.0	112.5	96.0
No.	1504 0511	1504 0511 S	1504 0321



Code	1814931	1814923	1814915
	8 drawers: 7x type 1, H = 67 mm 1x type 3, H = 207 mm	9 drawers: 8x type 1, H = 67 mm 1x type 2, H = 137 mm	10 drawers: 10x type 1, H = 67 mm
Description	Mobile workbench with 8 drawers	Mobile workbench with 9 drawers	Mobile workbench with 10 drawers
H	985	985	985
W	1100	1100	1100
D	550	550	550
LD	10x	15x	15x
CD	2x	3x	3x
	99.0	106.0	110.0
No.	1504 0701	1504 0810	1504 1000

1504 0511 + 1504 0511 S

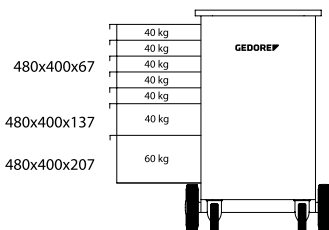

1504 0321

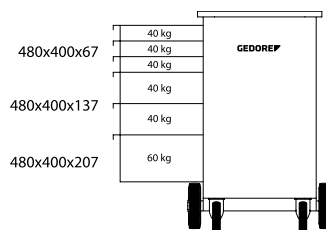

1504 0701

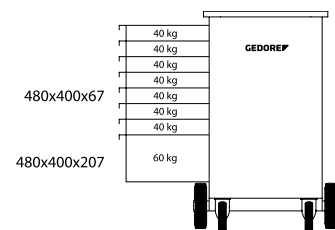

1504 0810

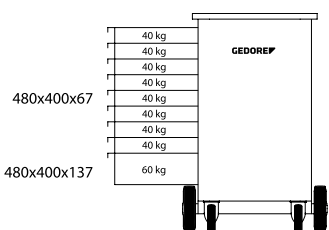

1504 1000

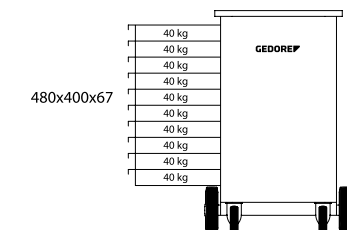

# 1504 XL

## MOBILE WORKBENCH EXTRA WIDTH

**Body:**

- > Dimensions: H 985 x W 1250 x D 550 mm
- > 30 mm thick multiplex beech wood worktop, surface additionally protected by linseed oil varnish
- > Large usable storage space with shelf and door
- > Heel protection for your safety
- > Sheet steel, corrosion resistant and scratch-proof powder-coated, GEDORE blue

**Drawers:**

- > Central locking with cylinder lock
- > 1 XL drawer (W 1055 x D 400), 6 wide drawers (W 640 x D 400 mm) fully extendable, removable
- > Each drawer with safety locking, single-hand operation
- > Ball-bearing guide rails
- > Can be individually equipped with lengthwise and crosswise dividers (can be ordered individually)
- > Load capacity per drawer 40 kg, bottom heavy-duty drawer 60 kg
- > Sheet steel, corrosion resistant and scratch-proof powder-coated, GEDORE blue

**GEDORE High-performance chassis:**

- > Total load capacity 700 kg, 500 kg when mobile
- > 2 high-performance wheels on roller bearings (fixed castors Ø 200 mm)
- > 2 smooth running wheels on ball bearings (swivel castors Ø 125 mm), both with total brake
- > The GEDORE trapezoidal axle construction secures smooth running, manoeuvrability and track-keeping also in case of maximum loads

**Accessories:**

- > 10 length- (LT) and 2 crosswise (QT) dividers from zinc-plated sheet steel

**Options:**

- > Can be equipped with GEDORE tool modules (1500 ES/1500 CT or 2005 CT)
- > Rear panel R 1504 XL-L can be added
- > Further drawer combinations on request
- > Special colours and designs available on request
- > Delivery without tools and accessories



H	W	D	mm		Code	No.
985	1250	550	30	120.0	1988468	1504 XL

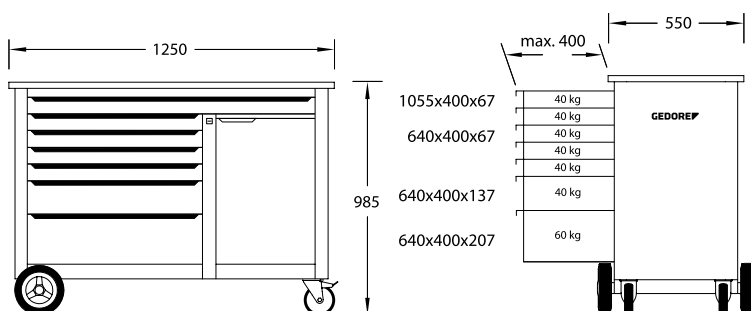





# BR 1504 MOBILE WORKBENCH

with self raising rear panel

**Body:**

- > Dimensions: H 985 x W 1100 x D 550 mm
- > 30 mm thick multiplex beech wood worktop, surface additionally protected by linseed oil varnish
- > Large usable storage space with shelf and door
- > With rear panel, square perforation 10 x 38 mm to fix hooks and tools, with lowering mechanism, can be raised by 2 gas springs
- > Heel protection for your safety
- > Sheet steel, corrosion resistant and scratch-proof powder-coated, GEDORE blue

**Drawers:**

- > Central locking with cylinder lock
- > Wide drawers (W 480 x D 400 mm) fully extendable, removable
- > Each drawer with safety locking, single-hand operation
- > Ball-bearing guide rails
- > Can be individually equipped with lengthwise and crosswise dividers (can be ordered individually)
- > Load capacity per drawer 40 kg, bottom heavy-duty drawer 60 kg
- > Sheet steel, corrosion resistant and scratch-proof powder-coated, GEDORE blue

**GEDORE High-performance chassis:**

- > Total load capacity 700 kg, 500 kg when mobile
- > 2 high-performance wheels on roller bearings (fixed castors Ø 200 mm)
- > 2 smooth running wheels on ball bearings (swivel castors Ø 125 mm), both with total brake
- > The GEDORE trapezoidal axle construction secures smooth running, manoeuvrability and track-keeping also in case of maximum loads

**Accessories:**

- > 2 distance modules No. 1500 ED-70 K
- > 10 length- (LT) and 2 crosswise (QT) dividers from zinc-plated sheet steel

**Options:**

- > Can be equipped with GEDORE tool modules (1500 ES/1500 CT)
- > Further drawer combinations on request
- > Special colours and designs available on request
- > Delivery without tools and accessories

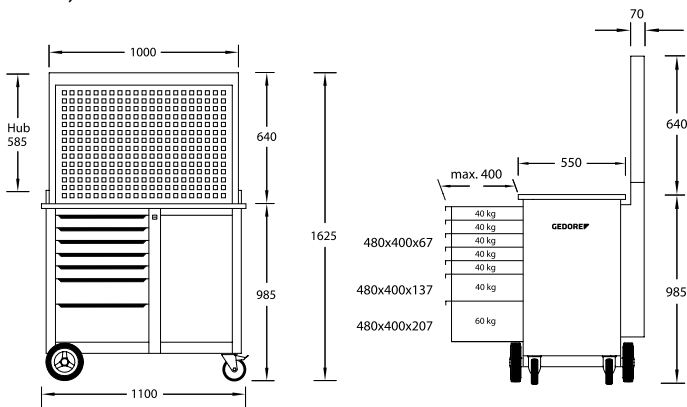

Description	H	W	D	mm	LD	CD	mm	Code	No.
<b>Workbench with rear panel</b>	985	1100	550	30	10x	2x	128.0	6624450	BR 1504 0511 L
<b>Workbench with rear panel + hook assortment</b>	985	1100	550	30	10x	2x	130.0	6623990	BR 1504 0511 LH
<b>Workbench with rear panel + vice</b>	985	1100	550	30	10x	2x	142.5	6624370	BR 1504 0511 S

411 >554

1500 ES / 1500 CT >98/105

# BR 1500 LH WORKBENCH WITH TOOL CABINET

**Body workbench:**

- > Dimensions: H 900 x W 2000 x D 875 mm
- > 40 mm thick multiplex beech wood worktop, surface additionally protected by linseed oil varnish
- > Large storage space with shutter
- > Heel protection for your safety
- > Sheet steel, corrosion resistant and scratch-proof powder-coated, GEDORE blue

**Body cabinet:**

- > Dimensions: H 890 x W 1810 x D 170 mm
- > Shutter with cylinder lock
- > Rear panel with square perforation 10 x 38 mm to fix hooks and tools
- > Sheet steel, corrosion resistant and scratch-proof powder-coated, GEDORE blue
- > Shutter from sheet steel, corrosion resistant and scratch-proof powder-coated, GEDORE blue

**Drawers workbench:**

- > Separate central locking of drawers and shutter with cylinder locks
- > 5 wide drawers (W 480 x D 550 mm), extendable up to 505 mm, removeable
- > Ball-bearing guide rails
- > Can be individually equipped with lengthwise and crosswise dividers (can be ordered individually)
- > Load capacity per drawer 40 kg
- > Sheet steel, corrosion resistant and scratch-proof powder-coated, GEDORE blue
- > Total load capacity (workbench) 2000 kg

**Accessories:**

- > 85-piece hook assortment 1500 HS 23
- > 9 length- (LT) and 9 crosswise (QT) dividers from zinc-plated sheet steel

**Options:**

- > Can be equipped with GEDORE tool modules (1500 ES/1500 CT)
- > Special colours and designs available on request
- > Delivery without tools and accessories

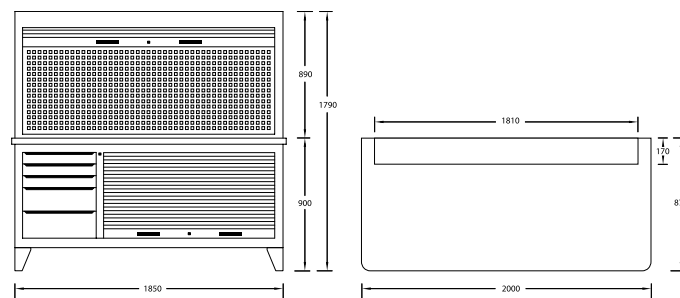
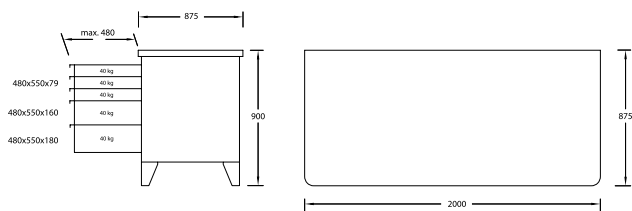

## BR 1500 VARIANTS



No.	BR 1500 LH	B 1500 L	R 1500 L
Description	Workbench with tool cabinet	Workbench without tool cabinet	Tool cabinet with blind, empty
H	1790	900	890
W	2000	2000	1810
D	875	875	170
mm	40	40	
LD	9x	9x	
CD	9x	9x	
kg	203.7	166.0	78.0
Code	6618210	6618050	6617910



# 1502

## MOBILE WORKBENCH

### Body:

- > Dimensions: H 875 x W 950 x D 550 mm
- > 25 mm thick multiplex beech wood worktop, surface additionally protected by linseed oil varnish
- > Large, easily-accessible spaces for bulky parts
- > Heel protection for your safety
- > Sheet steel, corrosion resistant and scratch-proof powder-coated, GEDORE blue

### Drawers:

- > Central locking with cylinder lock
- > 6 wide drawers (W 480 x D 400 mm) fully extendable, removable
- > Each drawer with safety locking, single-hand operation
- > Ball-bearing guide rails
- > Can be individually equipped with lengthwise and crosswise dividers (can be ordered individually)
- > Load capacity per drawer 40 kg, bottom heavy-duty drawer 60 kg
- > Sheet steel, corrosion resistant and scratch-proof powder-coated, GEDORE blue

### GEDORE High-performance chassis:

- > Total load capacity 700 kg, 500 kg when mobile
- > 2 high-performance wheels on roller bearings (fixed castors Ø 200 mm)
- > 2 smooth running wheels on ball bearings (swivel castors Ø 125 mm), both with total brake
- > The GEDORE trapezoidal axle construction secures smooth running, manoeuvrability and track-keeping also in case of maximum loads

### Accessories:

- > 2 distance modules No. 1500 ED-70 K
- > 10 length- (LT) and 2 crosswise (QT) dividers from zinc-plated sheet steel

### Options:

- > Can be equipped with GEDORE tool modules (1500 ES/1500 CT)
- > Special colours and designs available on request
- > Delivery without tools and accessories

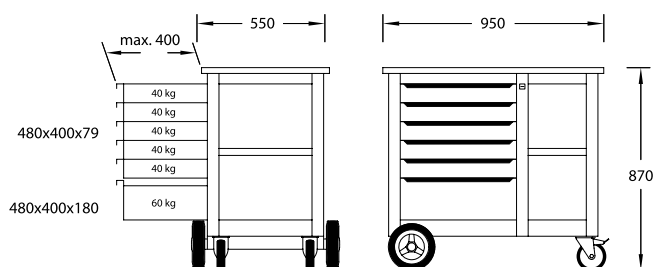

Description	H	W	D	mm	LD	CD		Code	No.
<b>Mobile workbench</b>	870	950	550	25	10x	2x	78.0	6620540	1502
<b>Mobile workbench with vice</b>	870	950	550	25	10x	2x	85.0	6620620	1502 S

## Folding workbench

### B 1525 FOLDING WORKBENCH

**Body:**

- > Dimensions: H 810/140 x W 1000 x D 700 mm
- > Strong beech wood worktop with zinc-plated steel edge protector - corrosion resistant
- > Stable folding, space-saving and mobile

**GEDORE Base:**

- > Total load capacity 500 kg
- > Steel tube, corrosion resistant and scratch-proof powder-coated, GEDORE blue
- > Delivery without tools and accessories

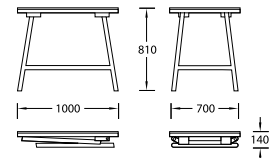

H	W	D	mm	kg	Code	No.
810	1000	700	30	32.0	6622910	B 1525

## Accessories for Workbenches

### R 1504 L REAR PANEL

- > Can be attached to workbench 1504 or 1505
- > Automatically raised by two gas springs, lockable with cylinder lock
- > Neat arrangement of tools
- > Square perforation 10 x 38 mm
- > Dimensions: H 640 x W 1000 x D 70 mm
- > GEDORE blue
- > Execution LH with hook assortment No. 1504 HS

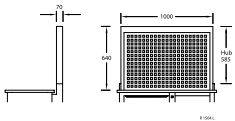

Description	H	W	D	kg	Code	No.
<b>Rear panel empty</b>	640	1000	70	28.0	6623800	R 1504 L
<b>Rear panel empty with hook assortment</b>	640	1000	70	30.0	6624020	R 1504 LH

### R 1504 XL-L REAR PANEL

- > Can be attached to workbench 1504 XL, 1506 XL
- > Automatically raised by two gas springs, lockable with cylinder lock
- > Neat arrangement of tools
- > Square perforation 10 x 38 mm
- > Dimensions: H 640 x W 1190 x D 70 mm
- > GEDORE blue
- > Execution LH with hook assortment No. 1504 HS



Description	H	W	D	kg	Code	No.
<b>Rear panel empty</b>	640	1190	70	29.0	2251787	R 1504 XL-L
<b>Rear panel empty with hook assortment</b>	640	1190	70	31.0	2251795	R 1504 XL-LH

### RT 1504 L REAR PANEL BOARD

- > Can be attached to workbenches 1504 and 1505
- > Square perforation 10 x 38 mm
- > GEDORE blue
- > Including attachment material



H	W	D	kg	Code	No.
715	1025	30	5.0	2477025	RT 1504 L



## Accessories Tool Trolleys / Workbenches



### 1500 H 13 ANTI-SLIP MAT

Products sold by the metre

- > For all drawers in GEDORE tool trolleys and workbenches
- > Various areas of application: Workshop, household, car, spare time...
- > Enormous slip resistance on many different surfaces
- > Can be cut to size
- > Resistant to temperatures from -30 °C to +100 °C
- > Melting point approx. +250 °C
- > Flame resistant
- > Resistant to chemicals
- > Shock- and noise absorbing
- > Dimensions: W 475 x L 2000 mm



L m	W		Code	No.
2	475	0.540	5790250	1500 H 13

## Drawer Partitions

### E-1500 - E-2500 LENGTHWISE DIVIDER

slotted

- > In two different heights
- > In five different lengths for varying drawer depths
- > In zinc-plated sheet steel



H	L	for use with		Code	No.
42	317	1580	0.136	5325840	E-1580/14
60	320	1430	0.190	5326570	E-2500/62
60	395	2005, 1504 XL (type 1), 1506 XL (type 1), 2430	0.235	1886932	E-2005 KL/42
60	397	1502 (1-5), 1504 (1-6), 2004 (type 1)	0.208	5326490	E-1504 KL/57
60	548	B 1500 (1-3), 1505 (1-3)	0.312	5315880	E-B 1500/38

### E-2005 CT LENGTHWISE DIVIDER

without slots

- > To fix the modules 2005 CT2

H		Code	No.
40	0.248	2104601	E-2005 CT H-40

### E-1580 CROSSWISE DIVIDER

- > Usage: 1580
- > In three different lengths, to fit the lengthwise dividers
- > In zinc-plated sheet steel



E-1580/11-40

L	H		Code	No.
40	40	0.012	1394878	E-1580/11-40
80	40	0.024	5325760	E-1580/11-80
120	40	0.036	5326140	E-1580/11-120

### E-3000 CROSSWISE DIVIDER

- > Usage: 1430, B 1500 (1-3), 1502 (1-5), 1504 (1-6), 1504 XL, 1505 (1-3), 1506 XL (type 1), 2004 (type 1), 2005 (type 1), 2430
- > In zinc-plated sheet steel



L	H		Code	No.
80	55	0.035	5326060	E-3000/37-80
120	55	0.050	5326220	E-3000/37-120

## Tool Cabinets

### 1400 L TOOL CABINET

**Body:**

- > Dimensions: H 970 x W 650 x D 250 mm
- > Sheet steel, corrosion resistant and scratch-proof powder-coated, GEDORE blue
- > With storage, three drawers and fixed tool holders, e.g. for set S 1400
- > With loose modules for sockets, ratchets, extensions, etc.

**Doors:**

- > Central locking with cylinder lock

**Drawers:**

- > 2 drawers (W 478 x D 210 x H 46 mm)
- > 1 drawer (W 478 x D 210 x H 72 mm)
- > Sheet steel, corrosion resistant and scratch-proof powder-coated, GEDORE blue

**Options:**

- > Special colours and designs available on request
- > Delivery without tools and accessories



H	W	D		Code	No.
970	650	250	33.0	6612600	1400 L

### 1401 L TOOL CABINET

**Body:**

- > Dimensions: H 970 x W 650 x D 250 mm
- > Sheet steel, corrosion resistant and scratch-proof powder-coated, GEDORE blue
- > Doors and body with Euro perforation 10 x 38 mm to fix hooks
- > With three drawers
- > With loose modules for sockets, ratchets, extensions, etc.

**Doors:**

- > Central locking with cylinder lock

**Drawers:**

- > 2 drawers (W 478 x D 210 x H 46 mm)
- > 1 drawer (W 478 x D 210 x H 72 mm)
- > Sheet steel, corrosion resistant and scratch-proof powder-coated, GEDORE blue

**Options:**

- > Special colours and designs available on request
- > Delivery without tools and accessories



Compilation	H	W	D		Code	No.
<b>Cabinet empty</b>	970	650	250	39.0	5610610	1401 L
<b>Cabinet 1401 L</b>	970	650	250	34.0	6611550	1401 LH
<b>+ hook assortment 1500 HS 11</b>						

## Tool Panels

### R 1500 L TOOL CABINET

- > Suitable as workbench top

**Body:**

- > Dimensions: H 890 x W 1810 x D 170 mm
- > Sheet steel, corrosion resistant and scratch-proof powder-coated, GEDORE blue
- > Rear wall with Euro perforation 10 x 38 mm to fix hooks

**Shutter:**

- > Central locking with cylinder lock
- > Sheet steel, corrosion resistant and scratch-proof powder-coated, GEDORE blue

**Options:**

- > Special colours and designs available on request
- > Delivery without tools and accessories



Compilation	H	W	D		Code	No.
<b>Cabinet empty</b>	890	1810	170	78.0	6617910	R 1500 L
<b>Cabinet R 1500 L</b>	890	1810	170	81.2	6619100	R 1500 LH
<b>+ hook assortment 1500 HS 23</b>						

### 1450 L TOOL PANEL

- > Proposed tool assortment serves as the basic equipment for workshop, garage or hobby
- > Further panels can be added in either direction, with special spacers for wall fitting
- > Made from solid sheet steel 1.5 mm thick, all 4 edges are bevelled
- > Euro perforation 10 x 38 mm
- > Dimensions: L 987 x H 493 mm
- > GEDORE blue powder-coated
- > Tools not supplied

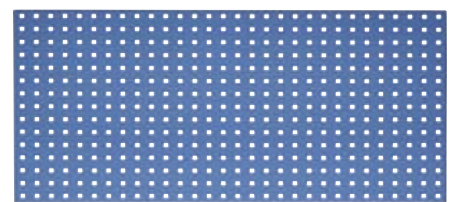

L	H		Code	No.
<b>987</b>	493	5.5	5617110	1450 L



## Tool holders / Tool hooks

Suitable for GEDORE tool trolleys and panels with square perforation 10 x 38 mm

### 1500 H 4 BASE PLATE

- > With M6 thread for universal fixing
- > Suitable for perforated panels with square perforation 10 x 38 mm
- > Zinc-plated



kg	Code	No.
0.026	1446185	1500 H 4

### 1500 H 2 - 1500 H 3 SPRING CLAMP

- > Suitable for perforated panels with square perforation 10 x 38 mm
- > Zinc-plated



1500 H 2-16

L mm	Ø	kg	Code	No.
31	10-12	0.025	2008351	1500 H 2-10
31	12-16	0.026	5803760	1500 H 2-13
31	16-18	0.027	2008378	1500 H 2-16
44	23-29	0.028	5803840	1500 H 3

### 1500 H 0 TOOL HOOK

straight mandrel

- > Ø 4 mm especially suitable for GEDORE screwdrivers with hanging hole
- > Suitable for perforated panels with square perforation 10 x 38 mm
- > Zinc-plated



L mm	Ø	kg	Code	No.
50	4	0.028	5803410	1500 H 0-50

### 1500 H 18 TOOL HOOK

straight mandrel

- > Suitable for perforated panels with square perforation 10 x 38 mm
- > Zinc-plated
- > Delivery without tools



1500 H 18-50

L mm	Ø	kg	Code	No.
50	6	0.034	2008386	1500 H 18-50
100	6	0.046	2008394	1500 H 18-100
150	6	0.056	2008408	1500 H 18-150

### 1500 H 5 PAPER ROLL HOLDER

- > Suitable for perforated panels with square perforation 10 x 38 mm



L mm	Ø	kg	Code	No.
250	6	0.094	5798660	1500 H 5

### 1500 H 1 TOOL HOOK

inclined hook end

- > Suitable for perforated panels with square perforation 10 x 38 mm
- > Zinc-plated



L mm	Ø	kg	Code	No.
50	4	0.028	5803680	1500 H 1-50

### 1500 H 29 TOOL HOOK

inclined hook end

- > Suitable for perforated panels with square perforation 10 x 38 mm
- > Zinc-plated
- > Delivery without tools



1500 H 29-50

L mm	Ø	kg	Code	No.
50	6	0.034	2008572	1500 H 29-50
100	6	0.046	2008580	1500 H 29-100

### 1500 H 30 TOOL HOOK

for sockets

- > Suitable for perforated panels with square perforation 10 x 38 mm
- > Zinc-plated



L <sub>1</sub>	L <sub>2</sub>	Ø	kg	Code	No.
15	40	6	0.034	2008599	1500 H 30

### 1500 H 20 TOOL HOLDER

vertical hook end

- > Suitable for perforated panels with square perforation 10 x 38 mm
- > Zinc-plated
- > Delivery without decoration



1500 H 20-35

L mm	Ø	kg	Code	No.
35	6	0.034	1879162	1500 H 20-35
75	6	0.046	2008440	1500 H 20-75
135	6	0.056	2008459	1500 H 20-135

## 1500 H 39 TOOL HOLDER

for pliers

- > Suitable for perforated panels with square perforation 10 x 38 mm
- > Zinc-plated
- > Delivery without tools



	Code	No.
0.065	2656582	1500 H 39

## 1500 H 19 TOOL HOLDER

double, straight mandrel

- > Suitable for perforated panels with square perforation 10 x 38 mm
- > Zinc-plated
- > Delivery without tools



1500 H 19-50

↳ mm ▷	∅		Code	No.
50	6	0.074	2008416	1500 H 19-50
100	6	0.098	2008424	1500 H 19-100
150	6	0.118	2008432	1500 H 19-150

## 1500 H 21 TOOL HOLDER

double, vertical hook end

- > For hammers and ratchets
- > Suitable for perforated panels with square perforation 10 x 38 mm
- > Zinc-plated
- > Delivery without tools



1500 H 21-50

↳ mm ▷	∅		Code	No.
35	6	0.076	2008475	1500 H 21-35
50	6	0.080	1879170	1500 H 21-50
75	6	0.090	2008483	1500 H 21-75

## 1500 H 22 TOOL HOLDER

for pliers

- > Suitable for perforated panels with square perforation 10 x 38 mm
- > Zinc-plated
- > Delivery without tools



1500 H 22-55

W	D		Code	No.
35	20	0.062	2008491	1500 H 22-35
55	20	0.066	1879189	1500 H 22-55

## 1500 H 31 ROUND HOLDER

- > Suitable for perforated panels with square perforation 10 x 38 mm
- > Zinc-plated
- > Delivery without tools



W	L		Code	No.
27	65	0.068	2008602	1500 H 31

## 1500 H 23 MACHINE HOLDER FOR BATTERY SCREWDRIVER

- > Suitable for perforated panels with square perforation 10 x 38 mm
- > Zinc-plated
- > Delivery without tools



1500 H 23-40

∅		Code	No.
40	0.068	2008513	1500 H 23-40
60	0.060	1879197	1500 H 23-60

## 1500 H 33 TUBE HOLDER

- > Suitable for perforated panels with square perforation 10 x 38 mm
- > Hook width 35 mm
- > Powder-coated
- > Delivery without decoration



1500 H 33-60

W	H	D	∅		Code	No.
58	67	74	60	0.114	2008629	1500 H 33-60
58	96	114	100	0.156	2008637	1500 H 33-100

## 1500 H 24 TOOL HOLDER

for screwdrivers

- > Suitable for perforated panels with square perforation 10 x 38 mm
- > Powder-coated
- > Delivery without tools



1500 H 24-6

Execution		Code	No.
<b>for 6 pieces</b>	0.100	1879200	1500 H 24-6
<b>for 12 pieces</b>	0.400	2008548	1500 H 24-12

## 1500 H 34-14 DRILL-BIT HOLDER

for 14 pieces

- > Suitable for perforated panels with square perforation 10 x 38 mm
- > With 14 holes, diam.: 2 ea. 3.0 4.2 6.5 7.5 8.5 16.5 mm, 1 ea. 10.5 12.5 mm
- > Powder-coated
- > Delivery without tools



W	H	D		Code	No.
200	60	37	0.200	2008645	1500 H 34-14





## 1500 H 27 SOCKET HOLDER

- > With 11 holes
- > Hole diameter 10x 25 mm and 1x 27.5 mm
- > Suitable for perforated panels with square perforation 10 x 38 mm
- > Powder-coated
- > Delivery without tools



W	H	D		Code	No.
352	60	54	0.500	1920634	1500 H 27

## 1500 H 25-3 TOOL HOLDER

for 3 cans

- > Suitable for perforated panels with square perforation 10 x 38 mm
- > Powder-coated
- > Delivery without decoration



W	Ø		Code	No.
300	70	0.600	1879219	1500 H 25-3

## 1500 H 37 SPANNER HOLDER

- > Suitable for perforated panels with square perforation 10 x 38 mm
- > For 8 spanners, suitable for no. 1 B, 2, 4, 6, 7, 7 R, 7 UR
- > Powder-coated
- > Delivery without tools



W	H	D		Code	No.
124	66	145	0.220	2008696	1500 H 37

## 1500 H 38 SPANNER HOLDER

- > Suitable for perforated panels with square perforation 10 x 38 mm
- > For 10 spanners, suitable for no. 2, 2, 6
- > Powder-coated
- > Delivery without tools



1500 H 38

W	H	D		Code	No.
75-147	227	60	0.400	1920626	1500 H 38

## 1500 H 28 SHELF

- > Suitable for perforated panels with square perforation 10 x 38 mm
- > Powder-coated



W	H	D		Code	No.
496	168	303	3.000	1933191	1500 H 28

## 1500 H 9 TRAY

- > A handy place to keep tools that are needed constantly
- > Suitable for perforated panels with square perforation 10 x 38 mm

1500 H 9-75



W	H	D		Code	No.
456	50	75	0.854	1446924	1500 H 9-75
456	50	100	0.854	5792540	1500 H 9-100

## 1500 H 10 TRAY

- > With four partitions, for often-needed small parts
- > Suitable for perforated panels with square perforation 10 x 38 mm



W	H	D		Code	No.
456	50	100	0.840	5792620	1500 H 10-100

## VS 19 H TOOL TRAY

- > For sockets
- > Suitable for perforated panels with square perforation 10 x 38 mm
- > Dimensions: W 570 x D 25-45 mm
- > In sheet steel, GEDORE blue



W	D		Code	No.
570	25-45	0.550	5152640	VS 19 H

## VS 245 H CHISEL HOLDER EMPTY

- > For 6 chisels
- > Suitable for perforated panels with square perforation 10 x 38 mm
- > Dimensions: W 195 x H 95 x D 22 mm
- > In sheet steel, GEDORE blue

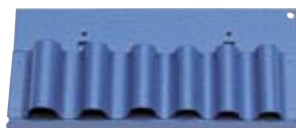

W	H	D		Code	No.
195	95	22	0.300	5456270	VS 245 H

## VS 1582 STORAGE TRAY

- > Suitable for perforated panels with square perforation 10 x 38 mm



W	H	D		Code	No.
320	100	90	1.118	5150270	VS 1582-3

# OVERVIEW CONTENTS HOOK ASSORTMENTS 1500 HS

No.	Code	No. Code kg	1500	1500	1500	1500	1500	1504	1585	1500	1500	1500	1500
			HS 11	HS 14	HS 17	HS 23	HS 28	HS	HS	HS-1150	HS-1006	HS-1023	HS-1090
			<b>5799980</b>	<b>5802010</b>	<b>5804060</b>	<b>5804220</b>	<b>2008742</b>	<b>5802440</b>	<b>5801550</b>	<b>2656892</b>	<b>2656884</b>	<b>2656906</b>	<b>2656914</b>
			2,680	2,388	3,514	4,958	1,768	1,958	0,654	3,056	19,516	3,269	8,284
1500 H 0-50	<b>5803410</b>		14	6	15	17		13		3	5	5	11
1500 H 1-50	<b>5803680</b>		23	20	32	43		13	10	12	39	35	15
1500 H 2-10	<b>2008351</b>									4		5	6
1500 H 2-13	<b>5803760</b>		1	6	4	12			5				
1500 H 3	<b>5803840</b>		2	1	2	10			5	1	11	2	2
1500 H 9-75	<b>1446924</b>										19	2	7
1500 H 20-35	<b>1879162</b>						4						
1500 H 20-75	<b>2008440</b>						2						
1500 H 20-135	<b>2008459</b>						2						
1500 H 21-35	<b>2008475</b>						6						
1500 H 22-35	<b>2008491</b>						2						
1500 H 23-40	<b>2008513</b>						1						
1500 H 24-6	<b>1879200</b>						1						
1500 H 27	<b>1920634</b>				1								
1500 H 29-50	<b>2008572</b>						3			17	10		3
1500 H 29-50	<b>2008580</b>						3						
1500 H 30	<b>2008599</b>										30		
1500 H 31	<b>2008602</b>						2						
1500 H 34-14	<b>2008645</b>						1						
1500 H 37	<b>2008696</b>						1						4
1500 H 38	<b>1920626</b>		1		1	1							
1500 H 39	<b>2656582</b>									2	6	4	6
VS 245 H	<b>5456270</b>		1	1	2	1		2		6			
VS 19 H	<b>5152640</b>			1	1	1							
H 6-8 B	<b>5079110</b>			1									
H 6-12 B	<b>5079540</b>							1					

## H 6 HOLDER

> For double open ended spanner sets no. 6

> Suitable for perforated panels with square perforation 10 x 38 mm



H 6-8 B



H 6-12 B



H 6-8 L



H 6-12 L



E-PH 6-12 L

Description	W	H	D	kg	Code	No.
Sheet metal holder, empty for 8 spanners no. 6	390	140	15	0.372	5079110	H 6-8 B
Sheet metal holder, empty for 12 spanners no. 6	600	170	15	0.655	5079540	H 6-12 B
Plastic holder, empty for 8 spanners no. 6	250	70	57	0.154	5070080	H 6-8 L

Description	W	H	D	kg	Code	No.
Plastic holder, empty for 12 spanners no. 6	325	100	57	0.270	5070160	H 6-12 L
Plastic holder, empty for 8 spanners no. 6				0.018	5073930	E-PH 6-8 L
Plastic holder, empty for 12 spanners no. 6				0.038	5074070	E-PH 6-12 L



## Suitable for perforated panels with square perforation 10 x 38 mm

1500 HS-1016	1500 HS-1000	1500 HS-1002	1500 HS-1400 GA	1500 HS-1005 A	1500 HS-1008	1500 HS-1151	1500 HS-1007	1500 HS-1400 Z	1500 HS-1093	1500 HS-1004	1500 HS-1092	1500 HS-1050	1500 HS-1024	1500 HS-1151 A	1500 HS-1091	1500 HS-1025
<b>2656922</b>	<b>2656930</b>	<b>2656949</b>	<b>2656957</b>	<b>2656965</b>	<b>2656973</b>	<b>2656981</b>	<b>2657015</b>	<b>2657023</b>	<b>2657031</b>	<b>2657058</b>	<b>2657066</b>	<b>2657074</b>	<b>2657082</b>	<b>2657090</b>	<b>2657104</b>	<b>265711</b>
0,845	1,109	4,526		1,985	9,087	1,662	6,215	0,907	0,817	1,927		0,996	1,887	1,620		0,908
	6	1	18	5	20	4	19	3	9	13	9	5	16	5	12	8
18	15	31	17	19	27	13	44	4	8	28	12	10	26	19	6	16
6	2	16		9	10	1	13	6	1	6		2	3	1	1	1
	5	6	6	12	7	5	7	7	2	6	1	1	11	5	1	4
					7		3									
	4	8	7	8	3	9	7	8		4	2	2	2	2		1
	9	15	19	23	21	13	23	1	2	20	1		6	15		
			24	1	3	1	1							1		
3	3	6	5	4	9	3	14	1	4	5	2	2	4	3	3	1
		8	14			1								1		

**S 1005 A** >89

**S 1000** >74

**S 1151 S 1151 A** >82/88

**S 1400 G** >77

# GEDORE WORKMO - THE MOBILE ARRANGEMENT-, TRANSPORT- AND WORKING SYSTEM

For maximum flexibility and safety



- > Combines transport, order and work – ergonomically and efficiently
- > Thanks to the modular design quickly disassembled into portable units
- > Multifunctional – with system
- > Ideal for all who need a flexible and mobile workplace
- > Individual modules or directly as a workstation
- > The intelligent way to work mobile and professionally!
- > Light and load secured

### Individual

- > WorkMo adapts exactly to the requirements of your individual working day
- > With the foam configurator the tool equipment can be arranged individually

### Compatible

- > with the Sortimo® L-BOXX® range
- > with the GEDORE tool modules 1500 ES/1500 CT

### Flexible

- > Expandable at any time (with castors, worktop etc.)
- > For further system components see Sortimo®

### Sturdy

- > Robust handling – lockable - durable
- > With rounded plastic edges as impact and scratch protection

- +** **Light**
  - > Low weight due to aluminum-plastic mix
  - > Ergonomic working heights

- +** **Drawer equipment**
  - > Ideal to equip WorkMo components with GEDORE tools – Be aware of the respective drawer widths:

- > B2 = maximum 2x 1/3 modules oder 1x 2/3 module

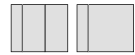

- > B3 = maximum 4x 1/3 modules oder 2x 2/3 modules

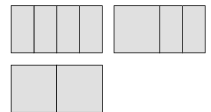

Not included



### CT-MODULES

>105

- > For individual arrangement

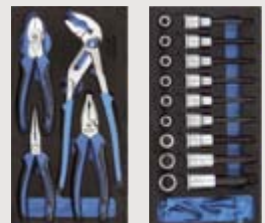



**NEW**

## 1110 WMW-2 TOOL TROLLEY WORKMO W2

- > Modular tool trolley
- > Consisting of: 1110 WM 24, 1110 WM 221, 1110 WMR 23 and 1110 WMHP 2
- > Mobile as complete unit or portable single units
- > Ideal for transportation from the workshop to changing workplaces
- > 6 drawers fully extendable suited for GEDORE 1500 ES/1500 CT modules
- > For 2x 1/3 modules or 1x 2/3 module
- > One compartment with locking device for GEDORE L-BOXX® 136 no. 1100 L (not included)
- > Light and sturdy aluminum-plastic mix
- > Mobile with roller skids with 4 swivel castors, 2 of them with total brake
- > Wooden worktop for assembly work
- > **Compatible with Sortimo® vehicle equipments and load securing**
- > **Crash tested**
- > Dimensions: W 526 x D 396 x H 1172 mm
- > **Weight advantage** (up to 50 % lighter than comparable solutions!)



optional: 1100 L L-BOXX® 136  
(not included)

**NEW**

## 1110 WMW-3 TOOL TROLLEY WORKMO W3

- > Modular tool trolley
- > Consisting of: 1110 WM 34, 1110 WM 321, 1110 WMR 23 and 1110 WMHP 3
- > Mobile as complete unit or portable single units
- > Ideal for transportation from the workshop to changing workplaces
- > 6 drawers fully extendable suited for GEDORE 1500 ES/1500 CT modules
- > For 4x 1/3 modules or 2x 2/3 modules
- > One compartment with locking device for GEDORE L-BOXX® 136 no. 1100 L and GEDORE S-BOXX® no. 1110 WMSB 3 (both not included)
- > Light and sturdy aluminum-plastic mix
- > Mobile with roller skids with 4 swivel castors, 2 of them with total brake
- > Wooden worktop for assembly work
- > **Compatible with Sortimo® vehicle equipments and load securing**
- > **Crash tested**
- > Dimensions: W 789 x D 396 x H 1172 mm
- > **Weight advantage** (up to 50 % lighter than comparable solutions!)



optional: 1100 L L-BOXX® 136 / 1110 WMSB 3 S-BOXX®  
(not included)

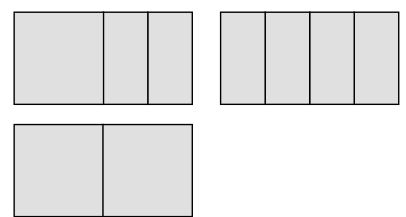
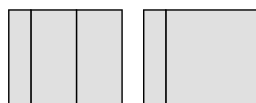

W	D	H	kg	Code	No.
526	396	1172	42.6	2954435	1110 WMW-2

W	D	H	kg	Code	No.
789	396	1172	52.8	2954443	1110 WMW-3

## GEDORE WorkMo - System components

### 1110 WM 24 TOOL BOX MODULE WORKMO W2

**NEW**

4 drawers H6

- > 4 drawers fully extendable suited for GEDORE 1500 ES/1500 CT modules
- > Light and sturdy aluminum-plastic mix
- > Compatible with Sortimo® vehicle equipments and load securing
- > Crash testet
- > Load capacity per drawer 30 kg
- > Dimensions: W 526 x D 396 x H 506 mm
- > Drawer size inside: W 418 x D 314 x H 89 mm

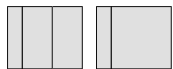

W	D	H		Code	No.
526	396	506	18.6	2954311	1110 WM 24

### 1110 WM 221 TOOL BOX MODULE WORKMO W2

**NEW**

2 drawers H6, compartment for L-BOXX®

- > 2 drawers fully extendable suited for GEDORE 1500 ES/1500 CT modules
- > One compartment with locking device for GEDORE L-BOXX® 136 no. 1100 L (not included)
- > Light and sturdy aluminum-plastic mix
- > Compatible with Sortimo® vehicle equipments and load securing
- > Crash testet
- > Load capacity per drawer 30 kg
- > Dimensions: W 526 x D 396 x H 506 mm
- > Drawer size inside: W 418 x D 314 x H 89 mm

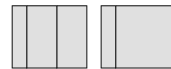

W	D	H		Code	No.
526	396	506	17.2	2954338	1110 WM 221

### 1110 WM 34 TOOL BOX MODULE WORKMO W3

**NEW**

4 drawers H6

- > 4 drawers fully extendable suited for GEDORE 1500 ES/1500 CT modules
- > Light and sturdy aluminum-plastic mix
- > Compatible with Sortimo® vehicle equipments and load securing
- > Crash testet
- > Load capacity per drawer 60 kg
- > Dimensions: W 789 x D 396 x H 506 mm
- > Drawer size inside: W 660 x D 314 x H 89 mm



W	D	H		Code	No.
789	396	506	24.1	2954346	1110 WM 34

### 1110 WM 321 TOOL BOX MODULE WORKMO W3

**NEW**

2 drawers H6, compartment for L-BOXX® + S-BOXX®

- > 2 drawers fully extendable suited for GEDORE 1500 ES/1500 CT modules
- > One compartment with locking device for GEDORE L-BOXX® 136 no. 1100 L and GEDORE S-BOXX® no. 1110 WMSB 3 (both not included)
- > Light and sturdy aluminum-plastic mix
- > Compatible with Sortimo® vehicle equipments and load securing
- > Crash testet
- > Load capacity per drawer 60 kg
- > Dimensions: W 789 x D 396 x H 506 mm
- > Drawer size inside: W 660 x D 314 x H 89 mm



W	D	H		Code	No.
789	396	506	20.1	2954354	1110 WM 321



## 1110 WMHP 2 WOOD PLATE

**NEW**

for WorkMo W2

- > 20 mm thick multiplex beech wood worktop
- > Add to WorkMo boxes W2 to get an additional work surface
- > Dimensions: W 571 x D 426 x H 41 mm



W	D	H		Code	No.
571	426	41	3.8	2954362	1110 WMHP 2

## 1110 WMHP 3 WOOD PLATE

**NEW**

for WorkMo W3

- > 20 mm thick multiplex beech wood worktop
- > Add to WorkMo boxes W3 to get an additional work surface
- > Dimensions: W 834 x D 426 x H 41 mm



W	D	H		Code	No.
834	426	41	5.6	2954370	1110 WMHP 3

## 1110 WMS 23 LOCKING SYSTEM

**NEW**

for WorkMo W2+W3

- > Protects drawers and BOXX<sup>®</sup>es against extraction
- > Secures the tools against unauthorised access



	Code	No.
0.920	2954389	1110 WMS 23

## 1110 WMR 23 ROLLER SKIDS, PAIR

**NEW**

for WorkMo W2+W3

- > Makes the tool box module mobile
- > 4 swivel castors, 2 with total brake



	Code	No.
3.0	2954397	1110 WMR 23

## 1110 WMT 23 DIVIDER SET

**NEW**

for WorkMo drawers W2+W3

- > To divide the drawers
- > 3 lengthwise dividers and mounting brackets



	Code	No.
0.250	2954419	1110 WMT 23

## 1110 WMSB 3 S-BOXX<sup>®</sup> W3

**NEW**

with window

- > Viewing window for a quick visual check of the contents
- > Ideal for the storage of expendables, such as screws etc.
- > Load capacity 12 kg
- > Dimensions: W 147 x D 351 x H 153 mm



W	D	H		Code	No.
147	351	153	0.500	2954427	1110 WMSB 3





---

# MOBILE TOOL STORAGE



---

## TOOL BOXES

>048

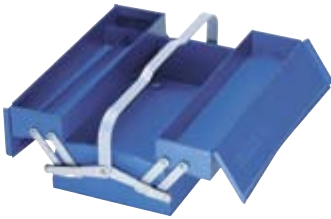

---

## TOOL CHESTS

>049



---

## TOOL CASES/ ROLLER TOOL CASES

>051



---

## GEDORE SORTIMO®

>054



# Tool Boxes

## TOOL BOXES

- > With riveted joints
- > Compartments to be fully pulled out
- > Great stability even if only one side is opened
- > Made from sheet steel, in GEDORE blue

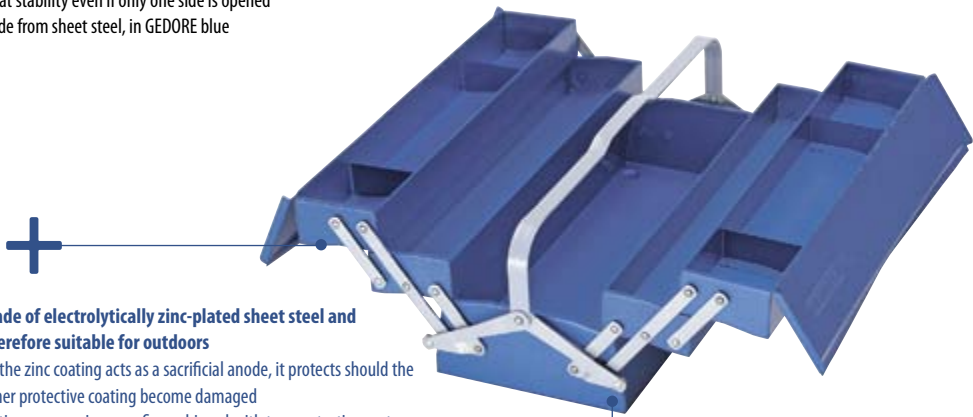

- > **Made of electrolytically zinc-plated sheet steel and therefore suitable for outdoors**
- > As the zinc coating acts as a sacrificial anode, it protects should the other protective coating become damaged
- > Optimum corrosion-proofing achieved with two protective coats, zinc and powder coating



The GEDORE PLUS for (stand) safety - especially with a one-sided pull-out

The GEDORE PLUS for storage space as against the traditional design

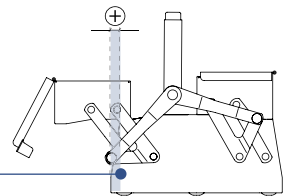

## 1263 L TOOL BOX

3 compartments

- > With riveted joints
- > Compartments to be fully pulled out
- > Great stability even if only one side is opened
- > GEDORE blue powder-coated
- > Dimensions: H 158 x W 420 x D 225 mm
- > Particularly suitable for tool assortments S 1150, S 1151 and S 1151 A

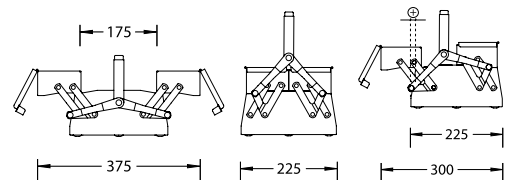
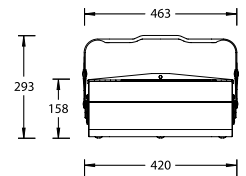
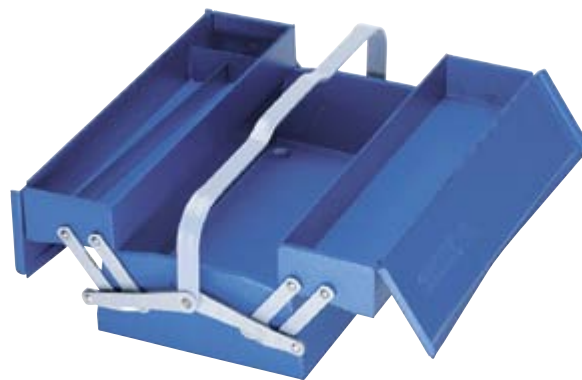

H	W	D		Code	No.
158	420	225	4.0	6608250	1263 L

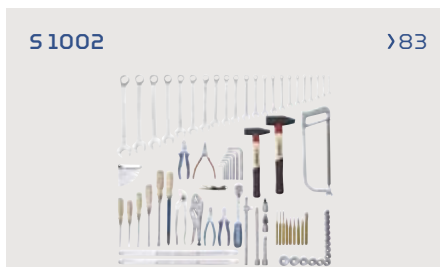

## 1265 L TOOL BOX

5 compartments

- > With riveted joints
- > Compartments to be fully pulled out
- > Great stability even if only one side is opened
- > GEDORE blue powder-coated
- > Dimensions: H 210 x W 420 x D 225 mm
- > Particularly suitable for tool assortments S 1151 and S 1151 A

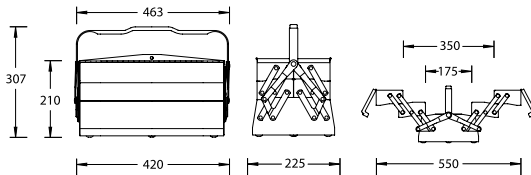
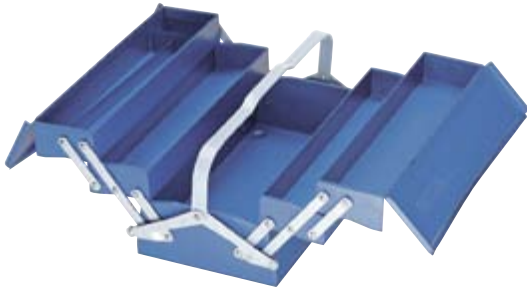

H	W	D		Code	No.
210	420	225	5.2	6609060	1265 L

## 1335 L TOOL BOX

5 compartments, long pattern

- > With riveted joints
- > Compartments to be fully pulled out
- > Great stability even if only one side is opened
- > GEDORE blue powder-coated
- > Dimensions: H 210 x W 535 x D 225 mm
- > Particularly suitable for tool assortments S 1024, S 1025, S 1151 and S 1151 A

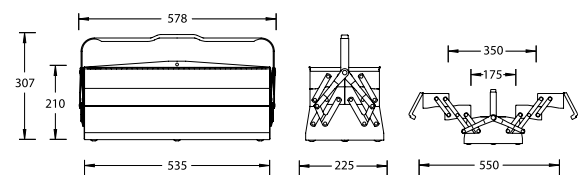
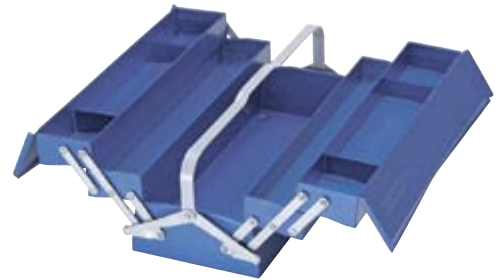

H	W	D		Code	No.
210	535	225	6.3	6610580	1335 L

### Tool Chests

- Central locking
- Drawers fully extendable

## 1410 L TOOL CHEST

- > With three large and three small drawers and carrying tray
- > All drawers fully extendable on runners
- > Particularly suitable for tool assortments S 1002 and S 1005 A
- > Made from sturdy sheet steel, fitted with central lock
- > In GEDORE blue
- > Dimensions: H 364 x W 663 x D 308 mm
- > Max. loading 75 kg



H	W	D		Code	No.
364	663	308	28.0	6614300	1410 L

## 1420 L TOOL CHEST

- > With three large drawers and carrying tray
- > All drawers fully extendable on runners
- > Particularly suitable for tool assortments S 1002 and S 1005 A
- > Made from sturdy sheet steel, fitted with central lock
- > In GEDORE blue
- > Dimensions: H 298 x W 610 x D 265 mm
- > Max. loading 75 kg



H	W	D		Code	No.
298	610	265	20.0	6615700	1420 L



## Tool Cases

### 1370 Z TOOL BOX

- › In special zinc-plated sheet steel for optimum protection against corrosion
- › The manufacture using pressure-joint technology means great rigidity
- › With removable small-parts compartment ES 1370 Z
- › Fitted with carrying strap E-1370 in nylon fabric with shoulder protector
- › Max. loading 25 kg



H	W	D		Code	No.
<b>224</b>	554	202	5.0	1497677	1370 Z
<b>69</b>	179	167	0.6	1497634	ES 1370 Z
			0.1	5600300	E-1370

### 1440 Z TOOL BOX JUMBO

zinc-plated

- › In special zinc-plated sheet steel for the heavy everyday-use
- › Optimum corrosion protection, spray water protected
- › Manufactured in pressure jointing technique, guarantees highest sturdiness
- › Robust metal fittings and protected hinges
- › Stopper to hold the lid open
- › Wide carrying handles
- › Max. loading 150 kg
- › Lockable through padlock
- › Lined interior
- › Removable tray for small parts (ES 1440)



H	W	D		Code	No.
<b>320</b>	698	387	17.0	6628280	1440 Z-70
<b>340</b>	841	427	21.0	6628360	1440 Z-83
<b>440</b>	918	537	30.0	6629170	1440 Z-91
<b>320</b>	998	387	22.0	6629250	1440 Z-100

### 1441 Z TRANSPORT FRAME

zinc-plated

- › In special zinc-plated sheet steel
- › Makes the tool boxes JUMBO 1440 / 1440 Z mobile
- › With 4 castors, 2 of them with brake
- › Delivery dismantled, for self-assembly



H	W	D		Code	No.
<b>135</b>	697	386	4.9	1497766	1441 Z-70
<b>135</b>	840	426	5.4	1497774	1441 Z-83
<b>135</b>	917	536	6.0	1497782	1441 Z-91
<b>135</b>	997	386	5.8	1497790	1441 Z-100

### 1440 TOOL BOX JUMBO

- › Sheet steel construction with strong handles (apart from 1440-45, 1440-64)
- › In GEDORE blue, waterproof
- › Strong joints, handles and stopper to hold the lid open
- › Special lining, with document partition and removable tray for small parts ES 1440
- › Please order separately transport frame 1441 Z
- › Special finishes available on request
- › 1440-45 without small parts tray
- › Supported load 1440-70, -83, -91, -100 up to 400 kg without using the fold-down handles. When lifting, static supporting power of the fold-down handles max. 150 kg

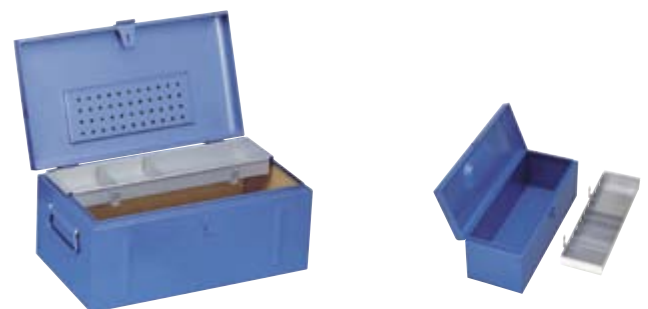

H	W	D		Code	No.
<b>230</b>	450	230	4,0	6612440	1440-45
<b>230</b>	640	230	7,0	6611040	1440-64
<b>320</b>	698	387	19,0	6616510	1440-70
<b>340</b>	841	427	23,0	6616780	1440-83
<b>440</b>	918	537	32,0	6616860	1440-91
<b>320</b>	998	387	25,0	6616940	1440-100



## WK 1000 L TOOL CASE EMPTY

- > From impact-resistant blown polypropylene, resistant to oil and acid and extremes of weather
- > With foam insert
- > Dimensions: W 437 x D 379 x H 160 mm
- > Delivery without tools



W	D	H		Code	No.
430	360	140	1.6	5600220	WK 1000 L

## WK 1091 L TOOL CASE EMPTY

- > From eco-friendly tanned cowhide
- > Carefully processed with strong industrial seams
- > Base insert from zinc-plated sheet steel
- > Edges reinforced with aluminium angle brackets, metal parts durable riveted
- > With feet to protect sensitive surfaces
- > Front part can be lowered for quick access to the tools, with two key locks to prevent inadvertent opening
- > Removable carrying strap with shoulder protector and sturdy carrying handle
- > Anti-theft protection due to two lockable notches, delivery includes two keys
- > Document partition
- > Interior measurements 430 x 200 x 290 mm



W	D	H		Code	No.
430	200	290	4.2	1953729	WK 1091 L

## WK 1015 L MOBILE TOOL CASE

empty

- > Handle with user-friendly telescopic grip
- > Widely spaced wheels with two inline castors for pulling without tipping
- > Sturdy aluminium frame with edge protector, trays of impact-resistant ABS plastic
- > When open, the case lid is prevented from locking unintentionally by the safety lid holder snapping into place
- > A4 document compartment in the lid
- > Removable tool panel with 22 tool pockets at the front and back in the lid
- > Removable cover for bottom tray with 15 tool pockets
- > Variably divisible bottom tray
- > Lockable with two-tilt cylinder locks and a combination lock
- > Comfort handle
- > Inside dimensions: 485 x 350 x 195 mm
- > Max. loading: 30 kg



W	D	H		Code	No.
485	350	195	8.0	2822326	WK 1015 L

## WK 1018 L TOOL CASE LARGE

empty

- > Sturdy aluminium frame with edge protector, trays of impact-resistant ABS plastic
- > When open, the case lid is prevented from locking unintentionally by the safety lid holder snapping into place
- > A4 document compartment in the lid
- > Removable tool panel with 22 tool pockets at the front and back in the lid
- > Removable cover for bottom tray with 15 tool pockets
- > Variably divisible bottom tray
- > Lockable with two-tilt cylinder locks and a combination lock
- > Comfort handle
- > Inside dimensions: 480 x 370 x 180 mm
- > Max. loading: 30 kg



W	D	H		Code	No.
480	370	180	6.0	2822342	WK 1018 L

S 1000 >69

1091 >71

S 1090 >75



# GEDORE L-BOXX® POWERED BY SORTIMO®

## The challenge: The perfect "To Go" workshop

- > GEDORE's Sortimo® transport box system relies on a tried-and-tested mobility standard
- > The perfect alliance for intelligent, efficient process and project design planning



## The terms of reference

- > Tools, machines and material must be easily, safely, quickly and conveniently transported to the place of use i.e. in a preferably resources-saving manner.
- > Lengthy loading times must be avoided at all cost - guaranteed load securing a pre-condition here!

## For your safety

- > Did you know that in an accident a screwdriver develops an 8 kg impacting load?
- > And in no way is a screwdriver a heavy tool! It is easy to envisage how a screwdriver or hammer turns into a projectile in an accident!
- > The GEDORE L-BOXX®es are fully compatible with Sortimo® vehicle fittings
- > GEDORE L-BOXX® quality is constantly examined on the basis of the strict Sortimo® directives. Sortimo® has its quality endorsed through crash tests organised by TÜV.
- > If it comes to the worst, at least the tools stay where they belong - securely in their GEDORE L-BOXX®

## Your advantage

- > Intelligent order systems
- > Flexible, modular and individual
- > Ideal for mobile deployments
- > Diverse and highly efficient
- > Quick accessing of tools - perfect organisation
- > Transport box standard - e.g. compatible with electrical tool manufacturers
- > Guaranteed safety

## The solution:

### The GEDORE "MIXX AND CLICK" kit

- > Well-conceived tool assortments and tool modules in the Sortimo®-Transportbox system
- > GEDORE L-BOXX® 136 with front grip and GEDORE i-BOXX® 72 powered by Sortimo® form the tried-and-tested basis for GEDORE "MIXX AND CLICK"
- > Every GEDORE L-BOXX® is supplied with a tool card in the lid for order and more storage space
- > Perfectly suited for mobile deployments - that's the "To Go" workshop

#### Multiple compatibility and thus extremely flexible and highly individualised:

- > The GEDORE "MIXX AND CLICK" kit features untold combinations based on your requirements and also on the modules of other manufacturers (e.g. electrical tools /Bosch)
- > This in combination with other Sortimo® components (transport boxes and system components) gives rise to a well organised mobile workshop.
- > Perfectly tailored to your personal needs.



### i-Modules Individual modules



You haven't found the right tool modules for yourself? Have a word with us - we manufacture the complete module individually to your requests and needs.

### GEDORE L-BOXX® 136, powered by Sortimo®

- > A sturdy construction
- > Easy and convenient transportation of the tool to the place of use
- > Impact-resistant ABS plastic
- > Standard lid handle to carry the L-BOXX® horizontally
- > Additional kind-to-hands front grip to carry the L-BOXX® vertically
- > Spray-protected
- > With tool card for order and more storage space
- > Easy-click system: Practical connector for two and more L-BOXX®es, for secure grip and easy transport
- > No-problem integration in vehicles with the TÜV-tested Sortimo® vehicle fittings



## 1100-01

### GEDORE L-BOXX® 136

### WITH ASSORTMENT

### MECHANIC

58 pieces

- > Suitable for tradesmen
- > A selection of essential tools
- > With Check-Tool insert for quick check of completeness
- > 1100 CT2-01 to retrofit existing L-BOXX®es 136



1100-01



1100 CT2-01

Contents	kg	Code	No.	Contents	kg	Code	No.
1993 U-20 1990-10 1995 19 10 11 12 13 14 15 16 17 18 19 21 22 24 60 CP 8 142 10 JC 8316-160 JC 8133-180 JC 600 H-500 110-256 45 S TFK 649 E-649 F 0063-08 H 42-10 SCL 43 TX-80 VDE 2170-2160 PH-077 4615 3 4533-2 8728 + 1100 L	8.3	2658194	1100-01	1993 U-20 1990-10 1995 19 10 11 12 13 14 15 16 17 18 19 21 22 24 60 CP 8 142 10 JC 8316-160 JC 8133-180 JC 600 H-500 110-256 45 S TFK 649 E-649 F 0063-08	6.8	2936828	1100 CT2-01
Description	kg	Code	No.	Description	kg	Code	No.
Foam insert 2/2 L-BOXX 136, empty	0.200	2690055		Foam insert 2/2 L-BOXX 136, empty	0.200	2690055	EI-1100-01

## 1100-02

### GEDORE L-BOXX® 136

### WITH ASSORTMENT

### ELECTRICIAN

36 pieces

- > Particularly suitable for electricians
- > A selection of essential tools
- > With Check-Tool insert for quick check of completeness
- > 1100 CT2-02 to retrofit existing L-BOXX®es 136



1100 CT2-02



1100-02

Contents	kg	Code	No.	Contents	kg	Code	No.
110-256 112-2510 600 H-500 60 CP 8 142 10 JC 8097 8133-180 JC VDE 8314-160 H VDE 8132-200 H VDE 8132 AB-200 H VDE 8098-160 H VDE 8094 4528 4629 0175-06 H 42-10 VDE 2170-2160 PH-077 4615 3 VDE 4616 45 E 4533-2 + 1100 L	7.7	2658208	1100-02	110-256 112-2510 600 H-500 60 CP 8 142 10 JC 8097 8133-180 JC VDE 8314-160 H VDE 8132-200 H VDE 8132 AB-200 H VDE 8098-160 H VDE 8094 4528 4629 0175-06	6.1	2936836	1100 CT2-02
Description	kg	Code	No.	Description	kg	Code	No.
Foam insert 2/2 L-BOXX 136, empty	0.200	2690047		Foam insert 2/2 L-BOXX 136, empty	0.200	2690047	EI-1100-02

# 1100-03 GEDORE L-BOXX® 136 WITH ASSORTMENT INSTALLATION

44 pieces

- > Particularly suitable for professions in the plumbing, heating and air conditioning
- > A selection of essential tools
- > With Check-Tool insert for quick check of completeness
- > With two stacked Check-Tool inserts
- > 1100 CT2-03-100 B or -600 D to retrofit existing L-BOXX®es 136



1100 CT2-03-100 B



1100 CT2-03-600 D



1100-03



Contents	kg	Code	No.
<b>7 R 10 13 17 19 24</b> <b>100 1.1/2 142 10 TL</b> <b>322000 232001</b> <b>225011 231000</b> <b>381000 380100</b> <b>600 H-500 110-256</b> <b>SCL 43 TX-80</b> <b>VDE 4616</b> <b>45 P H 42-10</b> <b>316500</b> <b>4533-2</b> <b>VDE 2170-2160 PH-077</b> <b>+ 1100 L</b>	10.3	2658216	1100-03

Contents	kg	Code	No.
<b>7 R 10 13 17 19 24</b> <b>100 1.1/2 142 10 TL</b> <b>322000 232001</b> <b>225011 231000</b> <b>381000 380100</b>	4.4	2940590	1100 CT2-03-100 B
<b>600 H-500 110-256</b> <b>SCL 43 TX-80</b> <b>VDE 4616</b> <b>45 P H 42-10</b> <b>316500</b>	2.6	2940604	1100 CT2-03-600 D

Description	kg	Code	No.
<b>Foam insert 2/2 L-BOXX 136, bottom, empty</b>	0.200	2689979	EI-1100-03-100 B
<b>Foam insert 2/2 L-BOXX 136, lid, empty</b>	0.200	2690039	EI-1100-03-600 D

# 1100-BASIC STARTER TOOL KIT

in L-BOXX® 136, 23 pieces

- > Basic outfit for all lots
- > 1100 CT2-BASIC to retrofit existing L-BOXX®es 136



1100-BASIC



1100 CT2-BASIC

Contents	kg	Code	No.
<b>7 10 12 13 14 15 16 17 18 19</b> <b>4528 4533-2</b> <b>406 95-200</b> <b>600 H-500</b> <b>8133-180 JC</b> <b>8316-180 JC</b> <b>142 10 TL</b> <b>2150 4 5,5 6,5</b> <b>2160 PH 1 2</b> <b>4615 3</b> <b>+ 1100 L</b>	6.1	2835983	1100-BASIC
<b>7 10 12 13 14 15 16 17 18 19</b> <b>4528 4533-2</b> <b>406 95-200</b> <b>600 H-500</b>	2.4	2835967	1100 CT2-BASIC

Description	kg	Code	No.
<b>Foam insert 2/2 L-BOXX 136, empty</b>	0.200	2835975	EI-1100 CT2-BASIC

1100-1094

> 592





# 1100-1.04

## UNIVERSAL PULLER SET

in L-BOXX® 136

- > Max. capacity up to 5 t
- > 2- and 3-arm cross-beam
- > With rigid and slim legs and extensions
- > Extra-slim pulling legs for cramped spaces are attached for self-mounting
- > The forged leg feet are very slim particularly suitable for barely accessible places
- > 12 different pullers can be combined
- > External Ø up to 130 mm, internal Ø up to 170 mm with a 200 mm clamping reach
- > 1100 CT2-1.04 to retrofit existing L-BOXX®es 136
- > With Check-Tool insert for quick check of completeness
- > As tools are fully sunk in the foam, the equipped insert can be stacked
- > Insert for use in drawers with min. dimensions 400 x 310 x 60 mm



1100-1.04

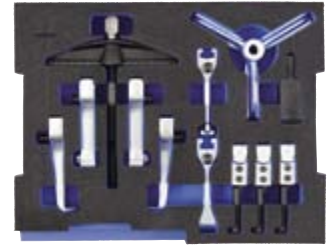

1100 CT2-1.04

Contents	kg	Code	No.	Contents	kg	Code	No.
1x 1.04/HP1A-B	6.3	2838362	1100-1.04	1x 1.04/HP1A-B	4.1	2836068	1100 CT2-1.04
1x 107/1A03				1x 107/1A03			
1x 106/A-100-B				1x 106/A-100-B			
3x 106/A-100-VB				3x 106/A-100-VB			
3x 106/A-100-S				3x 106/A-100-S			
3x 106/S101-S				3x 106/S101-S			
1x 1.1406200				1x 1.1406200			
+ 1100 L							
Description	kg	Code	No.	Description	kg	Code	No.
Foam insert 2/2 L-BOXX 136, empty	0.200	2836076		Foam insert 2/2 L-BOXX 136, empty	0.200	2836076	EI-1100 CT2-1.04

# 1100-1.04/12A

## PULLER SET INTERNAL/EXTERNAL

in L-BOXX® 136

- > Max. capacity 3 and 5 t
- > For clamping depths up to Ø 200 mm external, Ø 70-260 mm internal, and clamping reach up to 300 mm
- > In 3 of 4 spindles the spindle tip (ball/tip) can be rotated
- > Quick-release pulling legs with integral T-profile for a better transmission of force
- > The forged leg feet are very slim particularly suitable for barely accessible places
- > 2 rigid extensions each 100 and 150 mm with leg brake for quick adjustment of the legs
- > 1100 CT2-1.04/12A to retrofit existing L-BOXX®es 136
- > With Check-Tool insert for quick check of completeness
- > As tools are fully sunk in the foam, the equipped insert can be stacked
- > Insert for use in drawers with min. dimensions 400 x 310 x 90 mm



1100-1.04/12A



1100 CT2-1.04/12A



Contents	kg	Code	No.	Contents	kg	Code	No.
1x 1.04/1A	9.6	2927241	1100-1.04/12A	1x 1.04/1A	7.4	2927268	1100 CT2-1.04/12A
1x 1.04/2A				1x 1.04/2A			
2x 106/A-100-VB				2x 106/A-100-VB			
2x 106/B-150-VB				2x 106/B-150-VB			
1x 1.1406200				1x 1.1406200			
1x 1.2106350KS				1x 1.2106350KS			
+ 1100 L							
Description	W	D	H	kg	Code	No.	Description
Foam insert 2/2 L-BOXX 136, empty	400	310	90	0.200	2927276		EI-1100 CT2-1.04/12A

**NEW**



**NEW**

# 1100-1.41/2A SEPARATOR AND PULLER SET

in L-BOXX® 136

- > For clamping depths from Ø 22 to 115 mm and clamping reach up to 295 mm
- > Incl. threaded inserts for internal threads M8-M18
- > For loosening and pulling tightly-seated parts e.g. taper roller bearings and inner bearing races
- > The clamping reach can be extended with extension rods 1.38/AV-FV from 195 to 295 mm
- > 1100 CT2-1.41/2A to retrofit existing L-BOXX®es 136
- > With Check-Tool insert for quick check of completeness
- > As tools are fully sunk in the foam, the equipped insert can be stacked
- > Insert for use in drawers with min. dimensions 400 x 310 x 60 mm



1100 CT2-1.41/2A

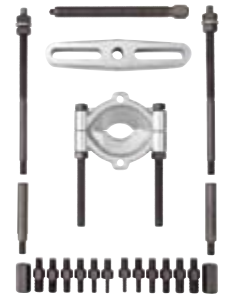

1100-1.41/2A

Contents		Code	No.
1x 1.38/2	11.5	2927284	1100-1.41/2A
1x 1.40/2			
1x 1.81/20			
1x 1.38/CV			
+ 1100 L			

Contents		Code	No.
1x 1.38/2	7.9	2927292	1100 CT2-1.41/2A
1x 1.40/2			
1x 1.81/20			
1x 1.38/CV			

Description		Code	No.
Foam insert 2/2 L-BOXX 136, empty	0.200	2927306	EI-1100 CT2-1.41/2A

# 1100-1.30 INTERNAL EXTRACTOR SET

in L-BOXX® 136, 7 pieces

- > For internal Ø 12 - 35 mm
- > For extremely-tightly-packed ball bearings, bearing races, bushings, and shaft seals Simmering®
- > Sliding hammer 1.7 kg and counter-support brace
- > 1100 CT2-1.30 to retrofit existing L-BOXX®es 136
- > With Check-Tool insert for quick check of completeness
- > As tools are fully sunk in the foam, the equipped insert can be stacked
- > Insert for use in drawers with min. dimensions 400 x 310 x 60 mm



1100-1.30



1100 CT2-1.30

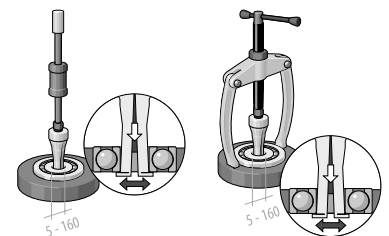

Contents		Code	No.
1.30/2	7.2	2836041	1100-1.30
1.30/3			
1.30/4			
1.30/4A			
1.30/5			
1.36/1			
1.35/2			
+ 1100 L			

Contents		Code	No.
1.30/2	5.0	2836025	1100 CT2-1.30
1.30/3			
1.30/4			
1.30/4A			
1.30/5			
1.36/1			
1.35/2			

Description		Code	No.
Foam insert 2/2 L-BOXX 136, empty	0.200	2836033	EI-1100 CT2-1.30

## 1100 CT1-7 COMBINATION SPANNER SET

in 1/2 L-BOXX® 136 Module, 12 pieces



Contents	kg	Code	No.
7 8 10 12 13 14 15 16 17 18 19 22 24	1.400	2835908	1100 CT1-7

Description	kg	Code	No.
Foam insert 1/2 L-BOXX 136, empty	0.100	2835924	EI-1100 CT1-7

## 1100 CT1-19 SOCKET SET 1/2"

in 1/2 L-BOXX® 136 Module, 21 pieces

12.5

1/2"



Contents	kg	Code	No.
19 8 9 10 11 12 13 14 15 16 17 18 19 21 22 24 27 30 32 1993 U-20 1990 KR-5 -10	2.800	2836009	1100 CT1-19

Description	kg	Code	No.
Foam insert 1/2 L-BOXX 136, empty	0.130	2836017	EI-1100 CT1-19

## 1100 CT1-20 SOCKET SET 1/4"

in 1/2 L-BOXX® 136 Module, 44 pieces

> For universal use with sockets and bits

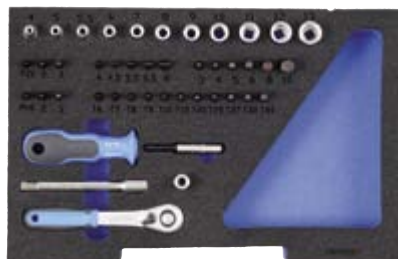

Contents	kg	Code	No.
20 4 5 5,5 6 7 8 9 10 11 12 13 2093 U-20 2090-4 699 620 676 680 4 4,5 5,5 6,5 8 685 3 4 5 6 8 10 690 1 2 3 690 PZD 1 2 3 687 TX T6 T7 T8 T9 T10 T15 T20 T25 T27 T30 T40	0.700	2835886	1100 CT1-20

Description	kg	Code	No.
Foam insert 1/2 L-BOXX 136, empty	0.100	2835894	EI-1100 CT1-20

6.3

1/4"



6.3

1/4"



## 1100 CT1-350 CHISEL SET

in 1/2 L-BOXX® 136 Module, 9 pieces

> Club hammer ROTBAND-PLUS for powerful blows



Contents	kg	Code	No.
106 112-2508 110-256 620 E-1000	2.300	2835932	1100 CT1-350

Description	kg	Code	No.
Foam insert 1/2 L-BOXX 136, empty	0.100	2835959	EI-1100 CT1-350



# 1101-7-7 R RING SPANNER SET

in i-BOXX® 72, 15 pieces

- > Often used sizes as practical combination ratchet spanner
- > In GEDORE i-BOXX® 72 No. 1101 L
- > Dimensions: W 367 x D 316 x H 72 mm



Contents		Code	No.
7 R 10 13 17 19	2.900	2836114	1101-7-7 R
7 6 8 11 12 14 15 16 18 21 22 24			
+ 1101 L			



# 1101-D 20 SOCKET SET 1/4"

in i-BOXX® 72, 58 pieces

- > For universal use with sockets and bits
- > In GEDORE i-BOXX® 72 No. 1101 L
- > Dimensions: W 367 x D 316 x H 72 mm



Contents		Code	No.
D 20 4 4,5 5 5,5 6 7 8 9 10 11 12 13 14	2.000	2836165	1101-D 20
2093 U-20 2090-2 -4 2095			
620 676 673 6,3 699			
680 4 5,5 6,5 8			
685 3 4 5 6 8 10			
685 X 5 6 8			
690 1 2 3			
690 PZD 1 2 3			
687 TX T6 T7 T8 T9 T10 T15 T20 T25 T27 T30 T40			
688 TX T10 T15 T20 T25 T27 T30 T40			
+ E-1101 BT			
+ 1101 L			



# 1101-19 SOCKET SET 1/2"

in i-BOXX® 72, 21 pieces

- > In GEDORE i-BOXX® 72 No. 1101 L
- > Dimensions: W 367 x D 316 x H 72 mm



Contents		Code	No.
19 8 9 10 11 12 13 14 15 16	4.050	2836084	1101-19
17 18 19 21 22 24 27 30 32			
1993 U-20			
1990 KR-5 -10			
+ 1101 L			



# 1101-142-2150 PLIERS/SCREWDRIVER ASSORTMENT

in i-BOXX® 72, 9 pieces

- > In GEDORE i-BOXX® 72 No. 1101 L
- > Dimensions: W 367 x D 316 x H 72 mm



Contents		Code	No.
2150 4 5,5 6,5	1.900	2836149	1101-142-2150
2160 PH 1 2			
4615 3			
8133-180 JC 8316-160 JC			
142 10 TL			
+ 1101 L			

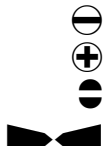

NEW

# 1101-1.29/1K

## BALL BEARING EXTRACTOR SET

in i-BOXX® 72

- › Ball bearing extractor set for more than 30 ball bearings
- › For removing ball bearings that are both on a shaft and in a housing
- › Non-destructive removal of deep-groove ball bearings without dismantling the shaft; no necessity to drill open the bearing cage (no chippings)
- › With Check-Tool insert for quick check of completeness
- › Insert for use in drawers with min. dimensions 340 x 260 x 60 mm
- › In GEDORE i-BOXX® 72 No. 1101 L
- › Dimensions: W 367 x D 316 x H 72 mm



1101-1.29/1K

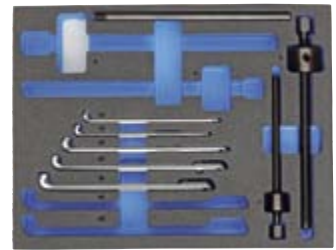

1101 CT-1.29/1K



Contents	for ball bearing No.	kg	Code	No.
<b>2 Heads with spindle no. 1.29/1 + 1.29/3</b>	6000 6001 6002 6003 6004 6005 6006 6007	2.610	2963485	1101-1.29/1K
<b>5 Heads with spindle no. 1.29/10 - 1.29/35</b>	6008 6009 6010 6011 6012 6200 6201 6202			
<b>1 Handle no. 1.29/0</b>	6203 6204 6205 6206 6207 6300 6301 6302	1.750	2964414	1101 CT-1.29/1K
<b>2 Heads with spindle no. 1.29/1 + 1.29/3</b>	6303 6304 6305 6306 6307 6403 6404			
<b>5 Heads with spindle no. 1.29/10 - 1.29/35</b>				
<b>1 Handle no. 1.29/0</b>				

Description	kg	Code	No.
<b>Foam insert i-BOXX 72, empty</b>	0.110	2964449	EI-1101 CT-1.29/3K

# 1101-1.29/3K

## BALL BEARING EXTRACTOR SET

in i-BOXX® 72

- › Ball bearing extractor set for more than 40 ball bearings
- › For removing ball bearings that are both on a shaft and in a housing
- › Non-destructive removal of deep-groove ball bearings without dismantling the shaft; no necessity to drill open the bearing cage (no chippings)
- › With Check-Tool insert for quick check of completeness
- › Insert for use in drawers with min. dimensions 340 x 260 x 60 mm
- › In GEDORE i-BOXX® 72 No. 1101 L
- › Dimensions: W 367 x D 316 x H 72 mm



1101-1.29/3K



1101 CT-1.29/3K



Contents	for ball bearing No.	kg	Code	No.
<b>4 Heads with spindle no. 1.29/1 - 1.29/5</b>	6000 6001 6002 6003 6004 6005 6006 6007 6008 6009 6010 6011	5.780	2964392	1101-1.29/3K
<b>7 Heads with spindle no. 1.29/10 - 1.29/45</b>	6012 6200 6201 6202 6203 6204 6205 6206 6207 6208 6209 6210			
<b>1 Handle no. 1.29/0</b>	6211 6212 6213 6300 6301 6302 6303 6304 6305 6306 6307 6308	4.920	2964430	1101 CT-1.29/3K
<b>4 Heads with spindle no. 1.29/1 - 1.29/5</b>	6309 6310 6311 6403 6404 6405 6406 6407			
<b>7 Heads with spindle no. 1.29/10 - 1.29/45</b>				
<b>1 Handle no. 1.29/0</b>				

Description	kg	Code	No.
<b>Foam insert i-BOXX 72, empty</b>	0.110	2964449	EI-1101 CT-1.29/3K

NEW

# 1100 W-001

## TOOL BOARD WITH PLIERS/ SCREWDRIVER ASSORTMENT

9 pieces

> To retrofit existing L-BOXX®es 136



# 1100 W-002 VDE

## TOOL BOARD WITH VDE PLIERS/ SCREWDRIVER ASSORTMENT

9 pieces

> To retrofit existing L-BOXX®es 136



Contents	Contents	kg	Code	No.
8133-180 JC	Assortment no. S 1100 W-001	1.500	2836181	1100 W-001
8316-180 JC	+ tool board no. ET-1100 W			
142 10 TL				
2150 4 5,5 6,5				
2160 PH 1 2				
4615 3				
+ ET-1100 W				
8133-180 JC	Assortment without tool board	1.100	2836211	S 1100 W-001
8316-180 JC				
142 10 TL				
2150 4 5,5 6,5				
2160 PH 1 2				
4615 3				

Contents	Contents	kg	Code	No.
VDE 8314-160 H	Assortment no. S 1100	1.200	2836203	1100 W-002 VDE
VDE 8132-160 H	W-002 VDE			
VDE 2170 2,5 3,5 5,5	+ tool board no. ET-1100 W			
VDE 2160 PH 1 2				
VDE 2160 PZ 1 2				
+ ET-1100 W				
VDE 8314-160 H	Assortment without tool board	0.800	2836238	S 1100 W-002 VDE
VDE 8132-160 H	board			
VDE 2170 2,5 3,5 5,5				
VDE 2160 PH 1 2				
VDE 2160 PZ 1 2				

1101-001

>425



1101-002

>423



1101-003 VDE

>587



1101-004

>425





## ET-1100 W LID TOOL BOARD

(without tools)

- › For or retrofittable for any L-BOXX®
- › Rubber straps and pockets for inserting tools
- › For orderliness and more storage space
- › Mounting material is included in delivery



W	D	H		Code	No.
375	20	310	0.400	2678322	ET-1100 W

## 1100 L GEDORE L-BOXX® 136 WITH EASY CARRY HANDLE

- › Rugged construction
- › Impact-resistant ABS plastic
- › Splash resistant
- › Top and front handle for variable transport of the L-BOXX®
- › With tool board for order and more storage space
- › Easy click plug-system: Practical plug connection for two or more L-BOXX®es, for secure grip and easy to carry
- › For integration in vehicles with Sortimo® vehicle equipment
- › External dimensions: W 442 x D 357 x H 151 mm
- › Internal dimensions: W 378 x D 311 x H 107 mm



W	D	H		Code	No.
442	357	151	2.2	2823691	1100 L

## 1100 R GEDORE L-BOXX® ROLLER

- › Practical, mobile trolley for all L-BOXX® types
- › Simply fit and click into place
- › Four swivel castors for self-assembly of which two have brakes
- › Load capacity up to 100 kg



W	D	H		Code	No.
646	492	184	3.8	2823756	1100 R

## 1101 K GEDORE I-BOXX® RACK ACTIVE

- › Shelf-like holder for any i-BOXX® 72 no. 1101 L (not included)
- › Easy click attaching system, thus compatible with the GEDORE L-BOXX® 136 no. 1100 L or with any other L-BOXX® on the market



W	D	H		Code	No.
442	357	100	1.100	2823713	1101 K

## 1101 L GEDORE I-BOXX® 72

- › Small parts case with transparent cover for getting an immediate impression
- › Ideal for keeping small parts and accessories
- › Optional inset boxes i3 for an individual range
- › Suitable for i-BOXX® Rack aktiv no. 1101 K
- › Comfort handle
- › Dimensions: W 367 x D 316 x H 72 mm



W	D	H		Code	No.
367	316	72	0.900	2823705	1101 L

## E-1101 BT GEDORE INSETBOX I3

- › For GEDORE i-BOXX® 72 no. 1101 L
- › For keeping small parts
- › Further subdivision possible with the 2 partitions



W	D	H		Code	No.
260	78	63	0.100	2840006	E-1101 BT

# 1102 L L-BOXX® MINI

- > Despite its small size the L-BOXX® Mini has all the practical functions of the well-liked L-BOXX®:
- > Two L-BOXX® Minis fit into an i-BOXX® 72

stackable, clicks into place with the others and has a practical handle.

It also has two removable partitions for housing incidental parts both easily and protectively.



# 1102 L GEDORE L-BOXX® MINI

- > Can be used together with the GEDORE BOXX®-system
- > Especially suitable for small tool sets
- > Also usable as small parts box, incl. divider set
- > Dimensions: W 260 x D 155 x H 63 mm



W	D	H		Code	No.
260	155	63	0.4	2950529	1102 L

## GEDORE L-BOXX® MINI



<p>1102-001 &gt;425</p>	<p>1102-003 &gt;423</p>	<p>1102-002 VDE &gt;588</p>	<p>1102-004 VDE &gt;588</p>
<p>1102-007 &gt;423</p>	<p>1102-008 &gt;423</p>	<p>1102-005 VDE &gt;588</p>	<p>1102-006 VDE &gt;588</p>

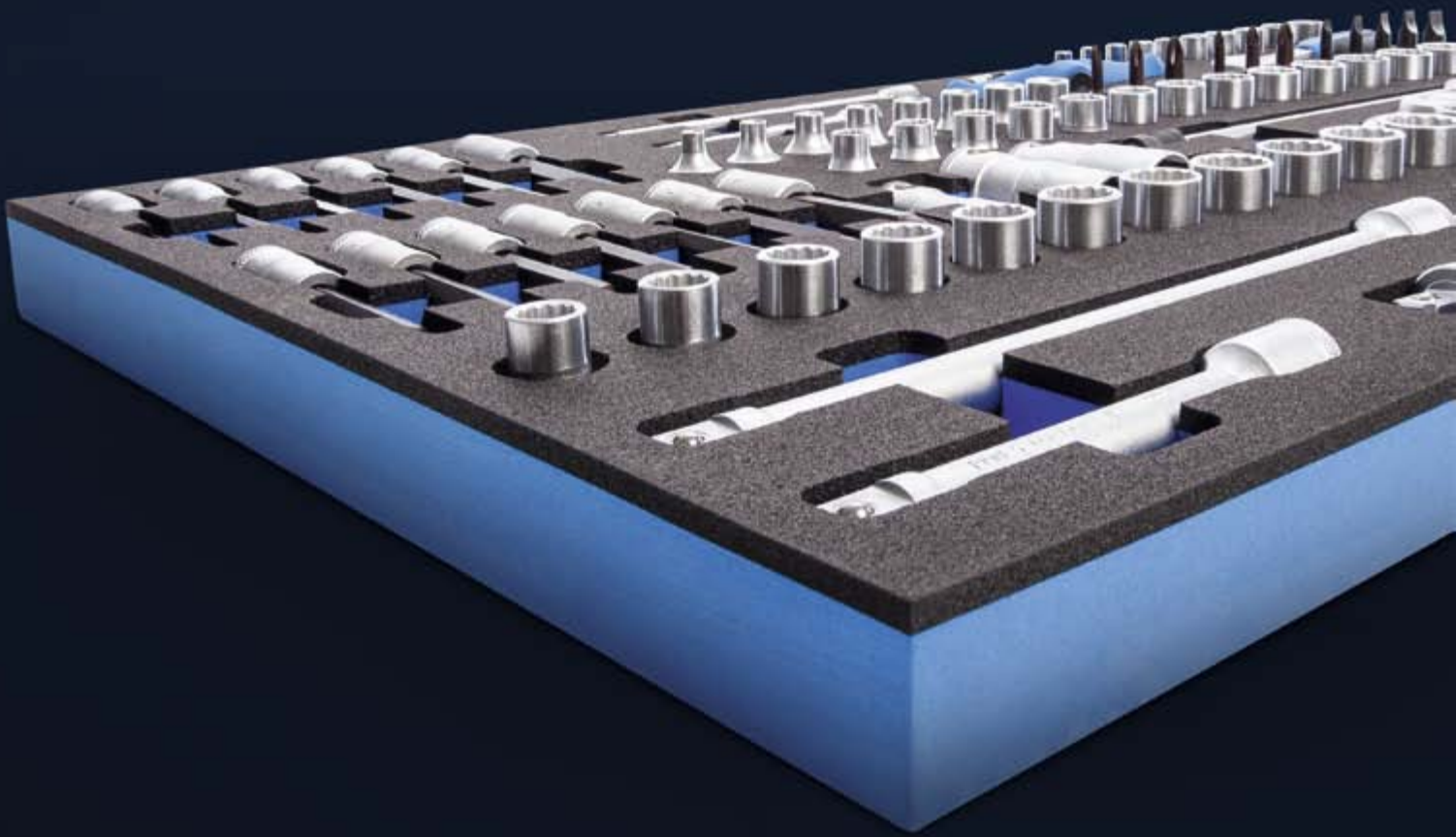

# TOOL ASSORTMENTS



**TOOL  
ASSORTMENTS**  
>068



**ES  
MODULES**  
>098



**CT  
MODULES**  
>105



# TOOL ASSORTMENTS OVERVIEW

Matching your chosen toolkit to the right tool trolley, workbench or cupboard

The table allows you to make the right choice of safe and secure storage for any particular tool set.

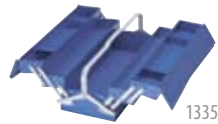
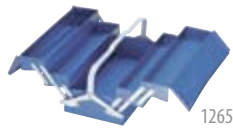
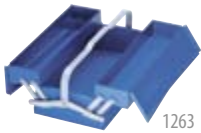















S 1150 - 41 pieces	S 1151 - 68 pieces S 1151 A - 69 pieces	S 1002 - 79 pieces	S 1004 - 80 pieces	S 1006 - 115 pieces	S 1005 A - 81 pieces	S 1400 G - 100 pieces	S 1400 G+Z - 134 pieces	S 1008 - 138 pieces	S 1007 - 180 pieces	S 1023 - 120 pieces	S 1500 ES-01 - 104 pieces	S 1500 ES-02 - 207 pieces	S 1500 ES-02 - 325 pieces	S 1093 - 26 pieces	S 1025 - 49 pieces	S 1024 - 62 pieces	S 1019 - 157 pieces	S 1022 - 158 pieces
●	●	only 1335	●	○	○	only 1335	○	○	○	○	○	○	○	○	○	only 1335	○	○
○	●	●	●	○	●	●	○	○	○	○	○	○	○	○	○	○	○	○
○	●	●	●	○	●	●	●	○	●	●	○	○	●	●	○	only 1578	○	○
○	●	●	●	○	●	●	●	●	●	●	●	○	●	●	○	●	○	B 1500
○	●	●	●	●	●	●	●	●	●	●	●	○	●	●	○	○	○	○
○	●	●	●	○	○	●	●	○	○	○	○	○	○	○	○	○	○	○
○	○	○	○	○	○	○	○	○	○	○	○	○	○	○	○	○	○	○
○	○	○	○	○	○	○	○	○	○	○	○	○	○	○	○	●	○	○
○	●	○	○	●	●	●	●	●	●	●	○	○	●	●	○	●	○	○
○	●	●	●	○	●	●	●	●	●	●	●	●	●	●	○	●	●	○
○	●	●	●	●	●	●	●	●	●	●	●	●	●	●	○	●	●	●

# 501 M BASIC TOOL SET

29 pieces

- > In practical black leather case with zip fastener
- > Packed with a basic assortment of tools for emergencies
- > Dimensions: W 300 x D 260 x H 45 mm
- > Tools in metric sizes













 2.5	Code	No.
	6511090	501 M
 <b>7</b> 10 11 12 13 17 19	 <b>4629</b>	 <b>2150</b> 3 4 5,5 6,5
 <b>142</b> 10 TL	 <b>8210</b> -160 JC	 <b>2160</b> PH 1 2
 <b>625</b> M	 <b>600</b> H -200	 <b>E-501</b> ST
 <b>647</b>		

# 1050 TOOL ASSORTMENT AUTODOCTOR

29 pieces

- > Breakdown assortment for cars
- > Set in metric sizes
- > In practical artificial leather wallet



 3.2	Code	No.
	6604770	1050
 <b>7</b> 8 10 12 13 14 17 19	 <b>625</b> M	 <b>600</b> H -300
 49 D 49 R	 <b>4611</b>	 <b>2150</b> 4 5,5 6,5
 <b>145</b> 10 C	 <b>0513</b> -09	 <b>2160</b> PH 2
 <b>8250</b> -180 JC		

# 1000 TOOL CASE TOURING

49 pieces



- > The perfect assortment for most problems
- > A carefully developed assortment of tools specified as the most useful
- > Packed in a handy plastic case
- > The reliable companion in a car, boat or small aircraft
- > Useful in the home - where good tools are always needed
- > All 49 pieces are well laid out and securely fastened, intermediate plate secures the tools in their pockets

- > With the TOURING repairs and maintenance become easy
- > Case made from impact-resistant polypropylene, resistant to oil and acid and extremes of weather, with Check-Tool insert
- > GEDORE vanadium tools, chrome-plated
- > Dimensions: 437x379x160 mm



1000

S 1000

Contents		Code	No.
<b>Tool set TOURING S 1000 + tool case WK 1000 L</b>	7.0	6600780	1000

Contents	Contents	Contents
7 6 7 8 10 11 12 13 14 15 17 19	2160 PH 1 2	97 -125 -150
19 10 11 12 13 14 15 17 19 22	4615 3	98 -125
1990 -5 -10	0513-09	99 12-3
1995	142 10 TL	100 -10
1993 U -20	8316 -160 JC	119 -4
42 2 (5/64AF) 2,5 3 4 5 6 8 10	8133 -180 JC	
2150 4,5,5 6,5	600 H -300	

# 1090 TOOL CASE ELECTRICIAN

90 pieces



- > The perfect tool set for the electrician or property manager
- > A thoughtful assortment for the work to be done
- > Packed in a strong plastic case
- > Aluminium frame, three steel hinges, screwed handle, fitted with built in locks
- > May be used wherever the right tools have to be always at hand
- > GEDORE vanadium tools, chrome-plated
- > Dimensions: W 480 x D 370 x H 180 mm



Contents		Code	No.
<b>Tool set S 1090 + tool case WK 1090 L</b>	13.2	6601590	1090
<b>Contents</b>		<b>Contents</b>	<b>Contents</b>
6 14x17 18x19 21x23 22x24		2160 PZ 1 2	VDE 8098 -160
8 4,4,5 5,5,5 6 7 8 9 10 11 12 13		VDE 2160 PH 1 2	VDE 8120 -160
20 4,4,5 5,5,5 6 7 8 9 10 11 13		VDE 2170 3,5 4 5,5 6,5	VDE 8250 -180
2087		4615 3,5	VDE 8132 AB -160
2095		173 5,5 8	VDE 8316 -200
2098		174 1	95 -175
2090 -4		745	99 10-2 10-4
2093 U -3		0513-09	101
42 2 (5/64AF) 2,5 3 4 5 6 7 8 10		4534 -3	112 A -250
60 CP 10		401	112 S
156 S		401 A [10x]	600 H -300
2153 5,5		145 10 JC	72 H -100
2161 PH 1		8096 -140	E-1090 LK LZ LF LS

# 1091 ELECTRICIANS TOOL CASE

18 pieces

- > Robust tool case with 18-piece basic assortment
- > **Particularly suitable for beginners in electronic professions**
- > From eco-friendly tanned cowhide
- > Carefully processed with strong industrial seams
- > Base insert from zinc-plated sheet steel
- > Edges reinforced with aluminium angle brackets, metal parts durable riveted
- > With feet to protect sensitive surfaces
- > Front part can be lowered for quick access to the tools, with two key locks to prevent inadvertent opening

- > Removable carrying strap with shoulder protector and sturdy carrying handle
- > Anti-theft protection due to two lockable notches, delivery includes two keys
- > Document partition
- > Interior measurements 430 x 200 x 290 mm



Contents	kg	Code	No.
<b>Tool set S 1091</b> <b>+ tool case WK 1091 L</b>	8.250	1953710	1091

Contents	Contents	Contents
<b>VDE 2133</b> 7 8 10	<b>4533</b> -2	<b>VDE 8132</b> -160 H
<b>VDE 2160</b> PH 1 2 3	<b>VDE 4616</b>	<b>VDE 8250</b> -180 H
<b>VDE 2170</b> 3 4 5,5	<b>4629</b>	<b>VDE 8316</b> -180 H
<b>4528</b>	<b>8097</b>	<b>E-1091</b> ST



# 1263 TOOL BOX WITH TOOL ASSORTMENT

3 compartments

- > For workshops and service stations
- > Tools in metric or inch sizes
- > Dimensions: H 158 x W 420 x D 225 mm



S 1151



1151-1263 / 1151 A-1263

12.5  
1/2"

Contents	kg	Code	No.
<b>Tool set S 1151 + tool box 1263 L</b>	15.8	6608330	1151-1263
<b>Tool set S 1151 A + tool box 1263 L</b>	15.8	6608410	1151 A-1263

Contents	kg
<b>2</b> 8x9 10x11 12x13 14x15 16x17 18x19 20x22	
<b>6</b> 6x7 8x9 10x11 12x13 14x15 16x17 18x19 20x22	
<b>19</b> 10 11 12 13 14 15 17 19 22 24 27 30 32	
<b>1990</b> -3 -5 -10	
<b>1987</b>	
<b>1995</b>	
<b>1993 U</b> -10 T	
<b>38</b> 16 [2x]	
<b>42</b> 2,5 3 4 5 6 8	

Contents	kg
<b>2150</b> 4 6,5 8	
<b>2160 PH 2</b>	
<b>50</b>	
<b>137</b> 10	
<b>145</b> 10 C	
<b>299</b>	
<b>100</b> -12	
<b>99</b> 10-4	
<b>97</b> -150	

Contents	kg
<b>625 M</b>	
<b>4611</b>	
<b>8250</b> -180 JC	
<b>8316</b> -160 JC	
<b>600 H</b> -500	
<b>1263 L</b>	

# 1265 TOOL BOX WITH TOOL ASSORTMENT

5 compartments

- > For workshops and service stations
- > Tools in metric or inch sizes
- > Dimensions: H 210 x W 420 x D 225 mm



S 1151



1151-1265 / 1151 A-1265

12.5  
1/2"

Contents	kg	Code	No.
<b>Tool set S 1151 + tool box 1265 L</b>	17.3	6609140	1151-1265
<b>Tool set S 1151 A + tool box 1265 L</b>	17.3	6609220	1151 A-1265

Contents	kg
<b>2</b> 8x9 10x11 12x13 14x15 16x17 18x19 20x22	
<b>6</b> 6x7 8x9 10x11 12x13 14x15 16x17 18x19 20x22	
<b>19</b> 10 11 12 13 14 15 17 19 22 24 27 30 32	
<b>1990</b> -3 -5 -10	
<b>1987</b>	
<b>1995</b>	
<b>1993 U</b> -10 T	
<b>38</b> 16 [2x]	
<b>42</b> 2,5 3 4 5 6 8	

Contents	kg
<b>2150</b> 4 6,5 8	
<b>2160 PH 2</b>	
<b>50</b>	
<b>137</b> 10	
<b>145</b> 10 C	
<b>299</b>	
<b>100</b> -12	
<b>99</b> 10-4	
<b>97</b> -150	

Contents	kg
<b>625 M</b>	
<b>4611</b>	
<b>8250</b> -180 JC	
<b>8316</b> -160 JC	
<b>600 H</b> -500	
<b>1265 L</b>	

# 1335 TOOL BOX WITH TOOL ASSORTMENT

5 compartments, long pattern

- > Tools in metric or inch sizes
- > Dimensions: H 210 x W 535 x D 225 mm



S 1151



1151-1335 / 1151 A-1335

12.5  
1/2"



Contents		Code	No.
<b>Tool set S 1151 + tool box 1335 L</b>	18.5	6610660	1151-1335
<b>Tool set S 1151 A + tool box 1335 L</b>	18.5	6610740	1151 A-1335

Contents	
	<b>2</b> 8x9 10x11 12x13 14x15 16x17 18x19 20x22
	<b>6</b> 6x7 8x9 10x11 12x13 14x15 16x17 18x19 20x22
	<b>19</b> 10 11 12 13 14 15 17 19 22 24 27 30 32
	<b>1990</b> -3 -5 -10
	<b>1987</b>
	<b>1995</b>
	<b>1993 U</b> -10T
	<b>38</b> 16 [2x]
	<b>42</b> 2,5 3 4 5 6 8
	<b>2150</b> 4 6,5 8

Contents	
	<b>2160 PH 2</b>
	<b>50</b>
	<b>137</b> 10
	<b>145</b> 10 C
	<b>299</b>
	<b>100</b> -12
	<b>99</b> 10-4
	<b>97</b> -150
	<b>625</b> M
	<b>4611</b>

Contents	
	<b>8250</b> -180 JC
	<b>8316</b> -160 JC
	<b>600 H</b> -500
	<b>1335 L</b>

S 1151 S 1151 A >82/88

1265 L >49

1263 L >48

1335 L >49

# S 1050

## TOOL ASSORTMENT AUTODOCTOR

29 pieces

- > Breakdown assortment for cars
- > Set in metric sizes
- > Also available in practical artificial leather wallet









1050







S 1050

Contents		Code	No.
<b>29 tools without wallet</b>	2.6	6604850	S 1050
<b>29 tools in wallet</b>	3.2	6604770	1050

Contents	Contents
 7 8 10 12 13 14 17 19	
 49 D 49 R	
 145 10 C	

Contents	Contents
 <b>625 M</b>	
 <b>4611</b>	
 <b>0513-09</b>	

Contents	Contents
 <b>8250 -180 JC</b>	
 <b>600 H -300</b>	
 <b>2150 4 5,5,6,5</b>	
 <b>2160 PH 2</b>	

# S 1000

## TOOL ASSORTMENT TOURING

49 pieces

- > The perfect assortment for most problems
- > A carefully developed assortment of tools specified as the most useful
- > GEDORE vanadium tools, chrome-plated
- > Also available with case











1000















S 1000



Contents		Code	No.
<b>49 tools without case</b>	5.3	6600190	S 1000
<b>Tool set TOURING S 1000 + tool case WK 1000 L</b>	7.0	6600780	1000

Contents	Contents
 7 6 7 8 10 11 12 13 14 15 17 19	
 19 10 11 12 13 14 15 17 19 22	
 <b>1990 -5 -10</b>	
 <b>1995</b>	
 <b>1993 U -20</b>	
 <b>42 2 (5/64AF) 2,5 3 4 5 6 8 10</b>	
 <b>2150 4 5,5,6,5</b>	

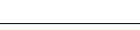
Contents	Contents
 <b>2160 PH 1 2</b>	
 <b>4615 3</b>	
 <b>0513-09</b>	
 <b>142 10TL</b>	
 <b>8316 -160 JC</b>	
 <b>8133 -180 JC</b>	

Contents	Contents
 <b>600 H -300</b>	
 <b>97 -125 -150</b>	
 <b>98 -125</b>	
 <b>99 12-3</b>	
 <b>100 -10</b>	
 <b>119 -4</b>	

# S 1090 TOOL CASE ELECTRICIAN

90 pieces

- > The perfect tool set for the electrician or property manager
- > A thoughtful assortment for the work to be done
- > GEDORE vanadium tools, chrome-plated
- > Also available with case



Contents	kg	Code	No.
<b>90 tools without case</b>	8.2	6601400	S 1090
<b>Tool set S 1090</b>	13.2	6601590	1090
<b>+ tool case WK 1090 L</b>			

Contents	Contents	Contents
6 14x17 18x19 21x23 22x24	<b>2160 PZ 12</b>	<b>VDE 8098 -160</b>
8 4 4,5 5,5 6 7 8 9 10 11 12 13	<b>VDE 2160 PH 12</b>	<b>VDE 8120 -160</b>
20 4 4,5 5,5 6 7 8 9 10 11 13	<b>VDE 2170 3,5 4 5,5 6,5</b>	<b>VDE 8250 -180</b>
<b>2087</b>	<b>4615 3,5</b>	<b>VDE 8132 AB -160</b>
<b>2095</b>	<b>173 5,5 8</b>	<b>VDE 8316 -200</b>
<b>2098</b>	<b>174 1</b>	<b>95 -175</b>
<b>2090 -4</b>	<b>745</b>	<b>99 10-2 10-4</b>
<b>2093 U -3</b>	<b>0513-09</b>	<b>101</b>
42 2 (5/64AF) 2,5 3 4 5 6 7 8 10	<b>4534 -3</b>	<b>112 A -250</b>
<b>60 CP 10</b>	<b>401</b>	<b>112 S</b>
<b>156 S</b>	<b>401 A [10x]</b>	<b>600 H -300</b>
<b>2153 5,5</b>	<b>145 10 JC</b>	<b>72 H -100</b>
<b>2161 PH 1</b>	<b>8096 -140</b>	<b>E-1090 LK LZ LF LS</b>

# S 1093

## VDE TOOL ASSORTMENT













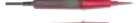

26 pieces

- > Particularly suited as the initial outfit for electrical specialists
- > The GEDORE tool case or tool trolley are suited for mobile assignments
- > Recommended hook assortment 1500 HS-1093 (26 pieces)

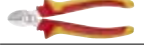

Contents		Code	No.
<b>26 tools in metric sizes</b>	4.8	2319942	S 1093

Contents	Contents	Contents
 <b>142 10 C</b>	 <b>VDE 2160 PZ 1 2</b>	 <b>8097</b>
 <b>VDE 8250 -180 H</b>	 <b>VDE 4616</b>	 <b>600 H -500</b>
 <b>VDE 8132 -160 H</b>	 <b>42 2 (S/64AF) 2,5 3 4 5 6 8 10</b>	 <b>112 A -250</b>
 <b>VDE 8314 -160 H</b>	 <b>4533 -2</b>	 <b>110 HS -318</b>
 <b>VDE 2170 4,5,5,6,5,8</b>	 <b>4528</b>	 <b>0175 -06</b>

# S 1004

## MECHANIC'S TOOL ASSORTMENT

80 pieces



































- > Particularly suitable for the rear panel R 1504 L
- > Recommended hook assortment 1500 HS-1004 (82 pieces)
- > Tools in metric sizes



12.5  
1/2"

Contents		Code	No.
<b>80 tools in metric sizes</b>	14.0	6600000	S 1004

Contents	Contents	Contents
 <b>7 8 9 10 11 12 13 14 15 16 17 18 19 21 22 23 24</b>	 <b>98 -125</b>	 <b>8719 2-8</b>
 <b>19 10 11 12 13 14 15 16 17 18 19 21 22 23 24 26 27 28 30 32</b>	 <b>119 -3 -5</b>	 <b>8722 2-8</b>
 <b>1987</b>	 <b>403</b>	 <b>8725 2-8</b>
 <b>1995</b>	 <b>640 -1800</b>	 <b>2150 4,6,5,8</b>
 <b>1990 -5 -10</b>	 <b>132 -150</b>	 <b>2153 5,5</b>
 <b>1993 U -10T</b>	 <b>0513-09</b>	 <b>2160 PH 2 3</b>
 <b>42 2 (S/64AF) 2,5 3 4 5 6 8 10</b>	 <b>8250 -180 JC</b>	 <b>2161 PH 2</b>
 <b>60 CP 8</b>	 <b>8132 -160 JC</b>	 <b>1.12 /01</b>
 <b>143 10 C</b>	 <b>8316 -160 JC</b>	
 <b>175 1.1/2</b>	 <b>424026</b>	
 <b>139 -400</b>	 <b>600 H -500</b>	
 <b>100 -10</b>	 <b>8701 2-8</b>	
 <b>99 10-3</b>		
 <b>97 -150 -200</b>		



# S 1400 G UNIVERSAL TOOL ASSORTMENT

100 pieces

- > Tools in metric sizes
- > Supplied in tool modules 1500 ES, suitable to fit in 5 drawers of the GEDORE tool trolleys (e.g. workster) and workbenches
- > Also available in tool cabinet or on tool boards

12,5  
1/2"



1400 G-1450-2



1400 G













S 1400 G

Contents		Code	No.
<b>100 tools in metric sizes</b>	17.7	6612790	S 1400 G
<b>Tool set S 1400 G</b>	46.7	6613250	1400 G
<b>+ tool cabinet 1400 L</b>			
<b>Tool set S 1400 G</b>	30.6	6617320	1400 G-1450-2
<b>+ 2x tool panel 1450 L</b>			
<b>+ hook assortment 1500 HS 17</b>			

	Contents
	<b>42</b> 1,3 1,5 2 (S/64AF) 2,5 3 4 5 6 8 10
	<b>2</b> 6x7 8x9 10x11 12x13 14x15 16x17 18x19 20x22
	<b>6</b> 6x7 8x9 10x11 12x13 14x15 16x17 18x19 20x22 21x23 24x27
	<b>19</b> 10 11 12 13 14 15 16 17 18 19 21 22 23 24 26 27 28 30 32
	<b>IN 19</b> 6 7 8 9 10 12 14
	<b>142</b> 10 JC
	<b>8132</b> -160 JC
	<b>8250</b> -180 JC
	<b>8316</b> -160 JC
	<b>97</b> -250
	<b>98</b> -125

	Contents
	<b>99</b> 12-5
	<b>100</b> -12
	<b>119</b> -1,5 -3 -4
	<b>600 H</b> -300
	<b>600 E</b> -500
	<b>225 E</b> -40
	<b>1993 U</b> -10 T
	<b>1987</b>
	<b>1995</b>
	<b>1990</b> -5 -10
	<b>2133</b> 5,5 6 7 8 9 10
	<b>2150</b> 4,5 5 6,5 8
	<b>2160 PH</b> 12

	Contents
	<b>60 CP</b> 8
	<b>137</b> 10
	<b>406</b>
	<b>403</b>
	<b>8701</b> 2-6
	<b>8719</b> 2-6
	<b>8722</b> 2-6
	<b>8728</b>
	<b>132</b> -150
	<b>424026</b>
	<b>1500 E-NL</b> [3x]

# S 1400 Z

## SUPPLEMENTARY TOOL ASSORTMENT

34 pieces

- > Tools in metric sizes
- > Ideally suited to the automotive sector
- > Recommended hook assortment 1500 HS-1400 Z (31 pieces)
- > Also available in tool cabinet



1400 GZ



S 1400 Z

Contents		Code	No.
<b>34 tools in metric sizes</b>	11.3	6612950	S 1400 Z
<b>Tool sets S 1400 G + S 1400 Z + tool cabinet 1400 L</b>	57.4	6613330	1400 GZ

Contents	Contents	Contents
<b>1990</b> -2,1/2 -3	<b>38 20</b> [2x]	<b>640</b> -1800
<b>INX 19 L</b> 6-100 8-100 10-100 12-100	<b>50</b>	<b>702</b> 13 M
<b>2153</b> 6,5	<b>54</b>	<b>4610</b>
<b>2161 PH 2</b>	<b>125</b> 1	<b>8729</b> [2x]
<b>27</b> 24x27 30x32	<b>128</b> 2-225	
<b>27 D</b>	<b>135</b> 13	
<b>28</b> PU	<b>299</b>	
<b>36</b> 1-140	<b>625</b> M	

# S 1150 UNIVERSAL TOOL ASSORTMENT

10  
3/4

41 pieces

- > For car repairs, household repairs and for the professional
- > Suitable to fit in GEDORE tool box no. 1263 L
- > Recommended hook assortment 1500 HS-1150 (45 pieces)
- > Tools in metric sizes



Contents	kg	Code	No.
<b>41 tools in metric sizes</b>	4.8	6606980	S 1150

Contents	Contents	Contents
<b>1 B</b> 8 10 11 13 14 15 17 19 22	<b>52</b>	<b>600 H</b> -300
<b>30</b> 6 7 8 9 10 11 12 13 14 15 17 19 22	<b>145</b> 10 C	
<b>3090</b> -3 -5 -10	<b>2150</b> 5,5 8	
<b>3095</b>	<b>2160</b> PH 2	
<b>3093</b> GU -3	<b>8250</b> -180 JC	
<b>42</b> 3 4 5 6 8 10	<b>97</b> -125	



























# S 1025

## SANITARY TOOL ASSORTMENT STARTER

49 pieces

- > User-friendly set for future plant mechanics in sanitary, heating and air condition technology
- > Suitable to fit in GEDORE tool box no. 1335 L



Contents		Code	No.
<b>49 tools</b>	7.0	2319896	S 1025
 <b>231000</b>	 <b>600 H -500</b>	 <b>7 R 10 13 17 19 24</b>	
<b>2250 3</b>	 <b>4533 -2</b>	 <b>920 11</b>	
 <b>232001</b>	 <b>2150 4 5,5</b>		
 <b>100 1.1/2</b>	 <b>2160 PH 1 PH 2</b>		
 <b>914424</b>	 <b>680 4-25 6,5-25</b>		
 <b>316500</b>	 <b>685 3-25 4-25 5-25 6-25</b>		
 <b>317000</b>	 <b>685 X 5-25 6-25 8-25</b>		
 <b>380100</b>	 <b>690 1-25 2-25</b>		
 <b>380200</b>	 <b>690 PZD 1-25 2-25 3-25</b>		
 <b>320000</b>	 <b>687 TX T8-25 T8-25 T9-25 T10-25 T15-25 T20-25 T25-25 T27-25 T30-25 T40-25</b>		
 <b>329000</b>	 <b>620</b>		
 <b>406</b>	 <b>4615 3</b>		
 <b>0513-09</b>			

# S 1024 SANITARY TOOL ASSORTMENT PROFI

62 pieces

- > User-friendly set for plant mechanics in sanitary, heating and air condition technology
- > Suitable to fit in GEDORE tool box no. 1335 L
- > Recommended hook assortment 1500 HS-1024 (68 pieces)
- > Tools in metric sizes



Contents	kg	Code	No.
<b>62 tools</b>	17.7	2319888	S 1024

Contents	Contents	Contents
<b>7 R 10 11 12 13 14 15 16 17 18 19 22 24</b>	<b>317000</b>	<b>620 H -1250</b>
<b>220020</b>	<b>380100</b>	<b>424026</b>
<b>231000</b>	<b>380200</b>	<b>312000</b>
<b>2180 3</b>	<b>378500</b>	<b>314000</b>
<b>2268 2</b>	<b>4615 3</b>	<b>320000</b>
<b>100 1 1.1/2</b>	<b>2150 4 5, 8</b>	<b>329000</b>
<b>914424</b>	<b>2160 PH 1 PH 2</b>	<b>232001</b>
<b>8314 -160 JC</b>	<b>42 1,3 1,5 2 (5/64AF) 2,5 3 4 5 6 8 10</b>	<b>232500</b>
<b>8133 -180 JC</b>	<b>1994</b>	<b>381030</b>
<b>112 -2510</b>	<b>403</b>	<b>1990 -5</b>
<b>110 HS -256</b>	<b>0513-09</b>	
<b>4533 -2</b>	<b>646</b>	
<b>316500</b>	<b>600 H -500</b>	
<b>316 501 502 503</b>		



# S 1151 TOOL ASSORTMENT

68 pieces

- > For workshops and service stations
- > Recommended hook assortment 1500 HS-1151 (50 pieces)
- > Tools in metric sizes
- > Also available in tool box or on tool boards

12.5  
1/2"



S 1151



1151-1263



1151-1265



1151-1335

Contents	kg	Code	No.
<b>68 tools in metric sizes</b>	9.6	6607010	S 1151
<b>Tool set S 1151 + tool box 1263 L</b>	15.8	6608330	1151-1263
<b>Tool set S 1151 + tool box 1265 L</b>	17.3	6609140	1151-1265
<b>Tool set S 1151 + tool box 1335 L</b>	18.5	6610660	1151-1335
<b>Tool set S 1151 + 2x tool panel 1450 L + hook assortment 1500 HS-1151</b>	17.3	6617240	1151-1450-2

	Contents
	<b>2</b> 8x9 10x11 12x13 14x15 16x17 18x19 20x22
	<b>6</b> 6x7 8x9 10x11 12x13 14x15 16x17 18x19 20x22
	<b>19</b> 10 11 12 13 14 15 17 19 22 24 27 30 32
	<b>1990</b> -3 -5 -10
	<b>1987</b>
	<b>1995</b>
	<b>1993 U</b> -10T

	Contents
	<b>38</b> 16 [2x]
	<b>42</b> 2,5 3 4 5 6 8
	<b>2150</b> 4 6,5 8
	<b>2160 PH 2</b>
	<b>50</b>
	<b>137</b> 10
	<b>145</b> 10 C

	Contents
	<b>299</b>
	<b>100</b> -12
	<b>99</b> 10-4
	<b>97</b> -150
	<b>625</b> M
	<b>4611</b>
	<b>8250</b> -180 JC
	<b>8316</b> -160 JC
	<b>600</b> H -500

# S 1002

## TOOL ASSORTMENT FOR TRACTORS

79 pieces

- > For tractors and other agricultural machines of all brands with metric screws
- > Suitable to fit in GEDORE tool trolley workster
- > Recommended hook assortment 1500 HS-1002 (91 pieces)



12.5  
1/2"



Contents	kg	Code	No.
<b>79 tools in metric sizes</b>	16.1	6600270	S 1002
<b>Contents</b>	<b>Contents</b>	<b>Contents</b>	<b>Contents</b>
<b>1 B</b> 6 7 8 9 10 11 12 13 14 15 16 17 18 19 20 22 23 24 27 28 30 32	<b>137 10</b>	<b>702 20 M</b>	
<b>19</b> 10 11 12 13 14 15 16 17 18 19 22 24 27 30 32	<b>145 10 C</b>	<b>4610</b>	
<b>IS 19</b> 12x2	<b>147 5,5 7 9 12</b>	<b>8000 A 2</b>	
<b>1990</b> -5 -10	<b>162 2</b>	<b>8000 J 2</b>	
<b>1987</b>	<b>100</b> -10	<b>8250</b> -180 JC	
<b>1995</b>	<b>99</b> 12-5 12-6 12-8	<b>8316</b> -160 JC	
<b>1993 U</b> -10 T	<b>97</b> -150	<b>600 H</b> -500 -1000	
<b>38 20</b> [2x]	<b>119</b> -3 -4 -5		
<b>42 3 4 5 6 8 10 12 14</b>	<b>403</b>		
	<b>132</b> -200		

# S 1016

## BASIC TOOL ASSORTMENT IN TOOL CASE

87 pieces

- > Ideal for mobile applications by fitters and service personnel
- > Suitable to fit in GEDORE tool case no. WK 1018 L
- > Also available with case or on tool board



6.3  
1/4"  
6.3  
1/4"  
mm  
12.5  
1/2"

Contents	kg	Code	No.
<b>87 tools without case</b>	8.5	2319918	S 1016
<b>Contents</b>	<b>Contents</b>	<b>Contents</b>	<b>Contents</b>
<b>7 8 9 10 11 12 13 14 15 17 19 22</b>	<b>676</b>	<b>8316</b> -180 JC	
<b>1993 U</b> -20	<b>699</b>	<b>8132</b> -160 JC	
<b>1990</b> -5	<b>2090</b> -4	<b>142 10 TL</b>	
<b>19</b> 10 12 13 14 15 16 17 18 19 22 24	<b>2093 U-20</b>	<b>600 H</b> -500	
<b>D 20</b> 4 5 6 7 8 9 10 11 12 13	<b>2150</b> 4 5,5 6,5 8	<b>406</b>	
<b>680</b> 4-25 5,5-25 6,5-25	<b>2160 PH</b> 12	<b>4534</b> -5	
<b>685</b> 3-25 4-25 5-25 6-25	<b>42 2 (5/64AF)</b> 2,5 3 4 5 6 8 10		
<b>685 X</b> 5-25 6-25 8-25	<b>97</b> -125 -150		
<b>687 TX</b> T10-25 T15-25 T20-25 T25-25 T27-25 T30-25 T40-25	<b>98</b> -125		
<b>690</b> 1-25 2-25	<b>99</b> 12-3		
<b>690 PZD</b> 1-25 2-25 3-25	<b>100</b> -10		
<b>620</b>	<b>119</b> -4		

# S 1006







































## TOOL ASSORTMENT HGV

115 pieces

12.5  
1/2  
20  
3/4

- > For service and repairs
- > Suitable to fit in GEDORE tool trolley workster
- > Recommended hook assortment 1500 HS-1006 (120 pieces)
- > Tools in metric sizes



Contents	 33.3	Code	No.
<b>115 tools in metric sizes</b>		6600940	S 1006
<b>Contents</b>	<b>Contents</b>	<b>Contents</b>	<b>Contents</b>
 <b>1 B 8 9 10 11 12 13 14 15 16 17 18 19 21 22 23 24 26 27 29 30 32</b>	 <b>60 CP 12</b>	 <b>644</b>	
 <b>19 10 11 12 13 14 15 16 17 18 19 21 22 23 24 26 27 28 30 32</b>	 <b>135 19</b>	 <b>132 -250</b>	
 <b>IN 19 5 6 7 8 9 10 12 14 17</b>	 <b>137 10</b>	 <b>702 20 M</b>	
 <b>1990 -5 -10</b>	 <b>146 10 C</b>	 <b>4534 -3</b>	
 <b>1985</b>	 <b>100 2</b>	 <b>4610</b>	
 <b>1987</b>	 <b>147 7 9 10</b>	 <b>8000 A 2 A 21</b>	
 <b>1995</b>	 <b>2160 PH 1 2 3 4</b>	 <b>8000 J 2 J 21</b>	
 <b>1993 U -10T</b>	 <b>100 -10</b>	 <b>8316 -160 JC</b>	
 <b>32 19 22 24 27 29 30 32 36 38</b>	 <b>97 -200</b>	 <b>248 ST -50</b>	
 <b>3290 -8 -16</b>	 <b>119 -4 -5 -6</b>	 <b>225 E -32</b>	
 <b>3287</b>	 <b>96 -200</b>	 <b>600 H -100 -1500</b>	
 <b>3295</b>	 <b>407</b>	 <b>8701 2 -10</b>	
 <b>3293 U -3</b>	<b>407 A [12x]</b>		

# S 1023

## TOOL ASSORTMENT FOR MECHANICAL ENGINEERS

120 pieces

- > Practical entry-level toolset
- > The range includes mechanical and electrical engineering tools
- > Suitable to fit in GEDORE tool trolley workster
- > Recommended hook assortment no. 1500 HS-1023 (53 pieces)



Contents	13.0	Code 1999060	No. S 1023
<b>120 tools in metric sizes</b>			
<b>1 B</b> 6 7 8 9 10 11 12 13 14 15 16 17 18 19 20 21 22	<b>VDE 8132</b> -200 H	<b>600 H</b> -500	
<b>D 20</b> 4 5 6 7 8 9 10 11 12 13	<b>VDE 8250</b> -180 H	<b>248 ST</b> -30	
<b>680</b> 4-25 5,5-25 6,5-25	<b>VDE 8314</b> -160 H	<b>8701</b> 2-8	
<b>685</b> 3-25 4-25 5-25 6-25	<b>VDE 2170</b> 4,5,5	<b>8719</b> 2-8	
<b>685 X</b> 5-25 6-25 8-25	<b>VDE 2160 PH</b> 1 2	<b>8722</b> 2-8	
<b>687 TX</b> T10-25 T15-25 T20-25 T25-25 T27-25 T30-25 T40-25	<b>VDE 4616</b>	<b>403</b>	
<b>690</b> 1-25 2-25	<b>4615 3</b>	<b>4528</b>	
<b>690 PZD</b> 1-25 2-25 3-25	<b>171 IS</b> 1,2 1,5,2	<b>710</b>	
<b>620</b>	<b>165 PH</b> 00 0	<b>745</b>	
<b>676</b>	<b>8305</b> -2	<b>4534</b> -3	
<b>699</b>	<b>8306</b> -5	<b>298</b> -04	
<b>2090</b> -4	<b>42</b> 1,3 1,5,2 (5/64AF) 2,5 3 4 5 6 8 10	<b>8354</b> -1	
<b>2093 U-20</b>	<b>97</b> -150	<b>8139</b> -220 TC	
<b>1993 U-20</b>	<b>100</b> -10		
<b>1990</b> -5 -10	<b>119</b> -3 -5		
<b>1995</b>			
<b>1987</b>			
<b>19</b> 8 9 10 11 12 13 14 15 16 17 18 19 21 22 24 27 30 32			

# S 1008











































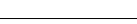
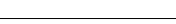





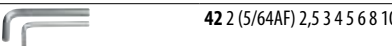





## MECHANIC'S TOOL ASSORTMENT

138 pieces

- > A useful selection of tools for many jobs
- > Suitable to fit in GEDORE tool trolley workster
- > Recommended hook assortment 1500 HS-1008 (107 pieces)
- > Tools in metric sizes

6,3  
1/4  
12,5  
1/2



Contents	 23.4	Code	No.
<b>138 tools in metric sizes</b>	23.4	6603610	S 1008
 2 6x7 8x9 10x11 12x13 14x15 16x17 18x19 20x22 21x23 24x27 25x28 30x32	 <b>137 10</b>	 <b>8000 J 2</b>	
 6 6x7 8x9 10x11 12x13 14x15 16x17 18x19 20x22 21x23 24x27 25x28 30x32	 <b>140</b>	 <b>8250 -180 JC</b>	
 <b>19 8 10 11 12 13 14 15 16 17 18 19 21 22 23 24 26 27 28 30 32</b>	 <b>143 10 C</b>	 <b>8132 -160 JC</b>	
 <b>1987</b>	 <b>144 7 C</b>	 <b>8316 -160 JC</b>	
 <b>1995</b>	 <b>156 5</b>	 <b>8367 -160 JC</b>	
 <b>1990 -5 -10</b>	 <b>175 1.1/2</b>	 <b>8551 1 2 3 4 5 6 7 8</b>	
 <b>1993 U -10 T</b>	 <b>139 -400</b>	 <b>600 H -500</b>	
 <b>2093 U -3</b>	 <b>100 -10</b>	 <b>248 ST -40</b>	
 <b>20 4 4,5 5,5 6 7 8 9 10 11 13</b>	 <b>99 10-3 12-5</b>	 <b>8701 2-8</b>	
 <b>2087</b>	 <b>97 -125 -150 -200</b>	 <b>8719 2-8</b>	
 <b>2090 -4</b>	 <b>98 -125</b>	 <b>8722 2-8</b>	
 <b>2095</b>	 <b>119 -3 -5</b>	 <b>424026</b>	
 <b>2098</b>	 <b>407</b>	 <b>8728</b>	
 <b>42 2 (5/64AF) 2,5 3 4 5 6 8 10</b>	 <b>640 -1800</b>	 <b>2150 3 4 5,5 6,5 8 10</b>	
 <b>60 CP 8</b>	 <b>132 -200</b>	 <b>2153 6,5</b>	
 <b>298 -04</b>	 <b>710</b>	 <b>2160 PZ 12</b>	
	 <b>745</b>	 <b>2160 PH 12 3</b>	
	 <b>0513-09</b>	 <b>2161 PH 12</b>	
	 <b>4534 -3</b>		
	 <b>8000 A 2</b>		



# S 1007 MECHANIC'S TOOL ASSORTMENT

179 pieces

- > A complete tool assortment for the professional
- > Suitable to fit in GEDORE tool trolley workster
- > Recommended hook assortment 1500 HS-1007 (131 pieces)
- > Tools in metric sizes

6,3  
1/4"  
12,5  
1/2"  
8  
5/16"



Contents	27.5	Code	No.
<b>179 tools in metric sizes</b>		6601080	S 1007
<b>Contents</b>	<b>Contents</b>	<b>Contents</b>	<b>Contents</b>
2 6x7 8x9 10x11 12x13 14x15 16x17 18x19 20x22 21x23 24x27 25x28 30x32	<b>175</b> 1.1/2	<b>8000</b> J 1 J 2 J 11 J 21	
6 6x7 8x9 10x11 12x13 14x15 16x17 18x19 20x22 21x23 24x27 25x28 30x32	<b>139</b> -400	<b>8250</b> -180 JC	
<b>19</b> 8 10 11 12 13 14 15 16 17 18 19 21 22 23 24 26 27 28 30 32	<b>100-10</b>	<b>8132</b> -160 JC	
<b>IN 19</b> 5 6 7 8 9 10 12 14 17	<b>99</b> 10-3 12-5	<b>8132 AB</b> -160 JC	
<b>1987</b>	<b>97</b> -125 -150 -200	<b>8316</b> -160 JC	
<b>1995</b>	<b>98</b> -125	<b>8316</b> -160 JC	
<b>1990</b> -5 -10	<b>119</b> -2 -3 -4 -5 -6 -8	<b>8367</b> -160 JC	
<b>1993 U</b> -10 T	<b>404</b>	<b>8551</b> 1 2 3 4 5 6 7 8	
<b>2093 U</b> -3	<b>407</b>	<b>600 H</b> -500	
<b>20</b> 4 4,5 5,5 5,6 7 8 9 10 11 13	<b>640</b> -1800	<b>248 ST</b> -40	
<b>2087</b>	<b>132</b> -200	<b>8701</b> 2-8	
<b>2090</b> -4	<b>710</b>	<b>8719</b> 2-8	
<b>2095</b>	<b>745</b>	<b>8722</b> 2-8	
<b>2098</b>	<b>880</b> 5,5 6,5 8 12	<b>8725</b> 2-8	
<b>42</b> 2 (5/64AF) 2,5 3 4 5 6 8 10	<b>885</b> 4 5 6 8 10	<b>424026</b>	
<b>60 CP</b> 8	<b>890</b> 2 3 4	<b>8728</b>	
<b>298</b> -04	<b>887 TX</b> T27 T30 T40 T45	<b>2150</b> 3 4 5,5 6,5 8 10	
<b>137</b> 10	<b>KB 819</b>	<b>2153</b> 6,5	
<b>140</b>	<b>K 1900</b>	<b>2160 PZ</b> 1 2	
<b>143</b> 10 C	<b>KB 820</b>	<b>2160 PH</b> 1 2 3	
<b>144</b> 7 C	<b>0513-09</b>	<b>2161 PH</b> 1 2	
<b>156</b> 5	<b>4534</b> -3		
	<b>8000 A</b> 1 A 2 A 11 A 21		

# S 1151 A

## TOOL ASSORTMENT

### INCH

69 pieces

- > For workshops and service stations
- > Recommended hook assortment  
1500 HS-1151 A (52 pieces)
- > Tools in inch sizes
- > Also available in tool box

12.5  
1/2

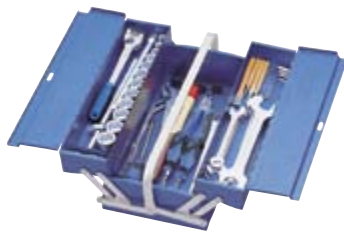

1151-1263



1151-1265



1151-1335

Contents		Code	No.
<b>69 tools in inch sizes</b>	9.4	6607280	S 1151 A
<b>Tool set S 1151 A + tool box 1263 L</b>	15.8	6608410	1151 A-1263
<b>Tool set S 1151 A + tool box 1265 L</b>	17.3	6609220	1151 A-1265
<b>Tool set S 1151 A + tool box 1335 L</b>	18.5	6610740	1151 A-1335

Contents	Contents	Contents
2 1/4x5/16AF 5/16x3/8AF 3/8x7/16AF 7/16x1/2AF 9/16x5/8AF 19/32x11/16AF 3/4x25/32AF 13/16x7/8AF	38 16 [2x]	100 -12
6 1/4x5/16AF 5/16x3/8AF 7/16x1/2AF 9/16x5/8AF 19/32x11/16AF 3/4x25/32AF 13/16x7/8AF 15/16x1AF	42 3/32AF 1/8AF 5/32AF 3/16AF 7/32AF (5,5MM) 1/4AF	99 10-4
D 19 5/16AF 3/8AF 7/16AF 1/2AF 9/16AF 5/8AF 11/16AF 3/4AF 7/8AF 15/16AF 1AF 1.1/16AF 1.1/4AF	2150 4,6,5 8	97 -150
1990 -3 -5 -10	2160 PH 2	625 A
1987	50	4611
1995	137 10	8250 -180 JC
1993 U -10 T	145 10 C	8316 -160 JC
	299	8601 1

# S 1005 A

## TOOL ASSORTMENT FOR CONSTRUCTION MACHINES





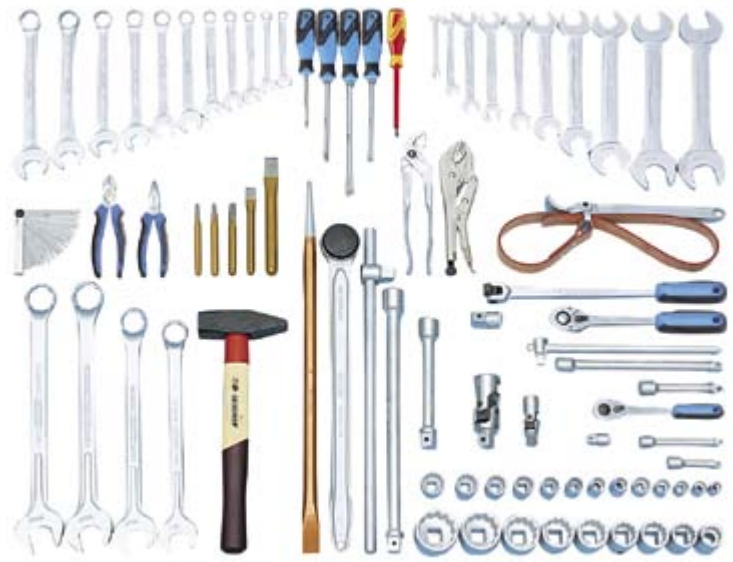





























81 pieces

- > For construction machinery using inch sizes, especially suitable for CATERPILLAR® machines
- > Suitable to fit in GEDORE tool trolley workster
- > Recommended hook assortment 1500 HS-1005 A (81 pieces)
- > Tools in inch sizes



10  
9/16  
12.5  
1/2  
20  
3/4



Contents	 kg	Code	No.
<b>81 tools in inch sizes</b>	22.9	6600510	S 1005 A
 <b>1 B</b> 1.1/16AF 1.1/8AF 1.1/4AF 1.5/16AF	 <b>3090</b> -3 -5	 <b>97</b> -150 -200	
 <b>6</b> 1/4x5/16AF 3/8x7/16AF 1/2x9/16AF 19/32x11/16AF 5/8x3/4AF 13/16x7/8AF 15/16x1AF 1.1/16x1.1/8AF 1.1/4x1.3/8AF 1.5/16x1.1/2AF	 <b>3019</b>	 <b>702</b> 26 A	
 <b>7</b> 3/8AF 7/16AF 1/2AF 9/16AF 5/8AF 11/16AF 3/4AF 13/16AF 7/8AF 15/16AF 1AF	 <b>3093 U</b> -10	 <b>36</b> 2-200	
 <b>D 19</b> 9/16AF 5/8AF 11/16AF 3/4AF 13/16AF 7/8AF 15/16AF 1AF	 <b>D 32</b> 7/8AF 1AF 1.1/16AF 1.1/8AF 1.1/4AF 1.5/16AF 1.1/2AF 1.5/8AF 1.3/4AF	 <b>8132 AB</b> -160 JC	
 <b>1993 U</b> -10 T	 <b>3290</b> -8 -16	 <b>8316</b> -160 JC	
 <b>1990</b> -5 -10	 <b>3287</b>	 <b>600 H</b> -1000	
 <b>1932</b>	 <b>3295</b>	 <b>137</b> -600	
 <b>1987</b>	 <b>3293 U</b> -2	 <b>2150</b> 8 12	
 <b>1995</b>	 <b>137</b> 10	 <b>2160 PH</b> 2 3	
 <b>1997</b>	 <b>145</b> 10 C	 <b>VDE 2170</b> 5,5	
 <b>D 30</b> 7/16AF 1/2AF 9/16AF 5/8AF 3/4AF	 <b>100</b> -12		
	 <b>99</b> 10-4 12-8		

# S 1019















































## TOOL ASSORTMENT CARS

157 pieces

6,3  
1/4  
12,5  
1/2

- > Ideal for maintenance and service work on cars
- > With torque wrench 1/2", 40-200 N-m
- > Suitable for cars of all brands with metric and TORX® screws
- > Supplied in tool modules 1500 ES
- > Suitable to fit in GEDORE tool trolley workster
- > For work benches 1502, 1504 XL, 1504 models 0511, 0620, 0701, 0810, 1000, 1506 XL models 2511 and 2810



Contents		Code	No.
<b>157 tools</b>		2319926	S 1019
	22.1		
<b>Contents</b>		<b>Contents</b>	<b>Contents</b>
 <b>6</b> 6x7 8x9 10x11 12x13 14x15 16x17 18x19 20x22 21x23 24x27		 <b>IKS 19 2 3 4</b>	 <b>119 -3 -4 -5 -6 -7 -8</b>
 <b>7 R</b> 8 10 12 13 14 15 16 17 18 19		 <b>INX 19 8 10</b>	 <b>600 H -500</b>
 <b>400</b> 8x10 10x11 12x14 17x19 13x15		 <b>IN 19 5 6 7 8 9 10 12 14 17</b>	 <b>248 ST -40</b>
 <b>2093 U -10</b>		 <b>IN 19 L 5-90 6-90 8-90 10-140 12-140 14-140</b>	 <b>38 20</b>
 <b>2087</b>		 <b>ITX 19 T20 T25 T27 T30 T40 T45 T50 T55 T60</b>	 <b>643</b>
 <b>2090-4</b>		 <b>ITX 19 L T20-100 T25-100 T27-100 T30-100 T40-100 T45-100 T50-100 T55-100 T60-100</b>	 <b>702 20 M</b>
 <b>2095</b>		 <b>708</b>	 <b>4550 -20</b>
 <b>2098</b>		 <b>142 10 JC</b>	 <b>133 D -150</b>
 <b>20</b> 4 5 5,5 6 7 8 9 10 11 12 13 14		 <b>8132 -160 JC</b>	 <b>132 -150</b>
 <b>IN 20 3 4 5 6 8</b>		 <b>8250 -180 JC</b>	 <b>8701 2-8</b>
 <b>TX 20 E4 E5 E6 E7 E8 E10</b>		 <b>8316 -160 JC</b>	 <b>8719 2-8</b>
 <b>ITX 20 T8 T9 T10 T15 T20 T25 T27 T30 T40</b>		 <b>8000 A 1 2 21</b>	 <b>8722 2-8</b>
 <b>1993 U-20</b>		 <b>8000 J 1 2 21</b>	 <b>8725 2-8</b>
 <b>1987</b>		 <b>2150 4,5,5,6,5,8</b>	 <b>8726</b>
 <b>1995</b>		 <b>2160 PH 1 2</b>	
 <b>1990 -5 -10</b>			
 <b>19</b> 10 11 12 13 14 15 16 17 18 19 21 22 23 24 26 27 28 30 32			
<b>IS 19</b> 10x1,6 12x2			

















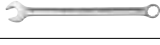









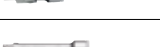











# S 1022 TOOL ASSORTMENT NFZ

133 pieces

- > Ideal for maintenance and service work on industrial vehicles of all brands with metric and TORX® screws
- > Suitable to fit in GEDORE tool trolley workster
- > For work benches 1502, 1504 XL, 1504 models 0511, 0620, 0701, 0810, 1506 XL models 2511 and 2810

12,5  
1/2  
20  
3/4



Contents		Code	No.
<b>133 tools</b>	45.5	2319934	S 1022
<b>Contents</b>		<b>Contents</b>	<b>Contents</b>
 <b>6</b> 6x7 8x9 10x11 12x13 14x15 16x17 18x19 20x22 21x23 24x27		 <b>2150</b> 4 5,5 6,5 8	 <b>135</b> 13 20
 <b>6</b> 30x32 36x41		 <b>2160</b> PH 12	 <b>646</b>
 <b>7 XL</b> 24 27 30 32 34 36 41		 <b>42 KEL</b> 2 2,5 3 4 5 6 8 10	 <b>600 H</b> -500 -1500
 <b>1993 U-20</b>		 <b>142</b> 10 JC	 <b>1500 ED-30</b> [12x]
 <b>1987</b>		 <b>8132</b> -160 JC	
 <b>1995</b>		 <b>8250</b> -180 JC	
 <b>1990</b> -5 -10		 <b>8316</b> -160 JC	
 <b>19</b> 10 11 12 13 14 15 16 17 18 19 21 22 23 24 26 27 28 30 32		 <b>97</b> -250	
 <b>IN 19</b> 6 7 8 9 10 12 14		 <b>98</b> -125	
 <b>K 19 L</b> 10 13 14 16 17 18 19 21 22 23 24 27		 <b>99</b> 12-5	
 <b>TX 19</b> E10 E11 E12 E14 E16 E18 E20 E24		 <b>100</b> -12	
 <b>ITX 19</b> T20 T25 T27 T30 T40 T45 T50 T55		 <b>119</b> -1,5 -3 -4	
 <b>SL 1916</b>		 <b>600 H</b> -300	
 <b>3293 U</b> -2		 <b>137</b> 10	
 <b>32</b> 22 24 27 30 32 36 38 41 46 50		 <b>403</b>	
 <b>3287</b>		 <b>39</b>	
 <b>3290</b> -8 -16		 <b>8138</b> -200 JC	
 <b>ITX 32</b> T60 T70 T80 T90 T100			



# S 1500 ES-01

## MODULE ASSORTMENT SMALL





























104 pieces

- > General basic range for beginners in all professions
- > Tools in metric sizes
- > Proved GEDORE ES tool modules from ABS
- > For tool trolley workster and workbench 1506 XL models 2511 and 2810

6,3  
1/4  
12,5  
1/2



Contents		Code	No.
<b>1500 ES-1 B</b>	12.1	2319845	S 1500 ES-01
<b>1500 ES-19</b>			
<b>1500 ES-1993 U-20</b>			
<b>1500 ES-20</b>			
<b>1500 ES-145</b>			
<b>1500 ES-350</b>			
<b>1500 ES-2150 PH</b>			

Contents	Contents	Contents
 <b>1 B</b> 6 7 8 9 10 11 12 13 14 15 16 17 18 19 20 21 22	 <b>2090-4</b>	 <b>8316</b> -160 JC
 <b>42 2</b> (5/64AF) 2,5 3 4 5 6 8 10	 <b>2095</b>	 <b>97</b> -250
 <b>19</b> 10 11 12 13 14 15 16 17 18 19 21 22 23 24 26 27 28 30 32	 <b>2098</b>	 <b>98</b> -125
 <b>IN 19</b> 6 7 8 9 10 12 14	 <b>20</b> 4 5 5,5 6 7 8 9 10 11 12 13 14	 <b>99</b> 12-5
 <b>1993 U-20</b>	 <b>IN 20</b> 3 4 5 6 8	 <b>100</b> -12
 <b>1987</b>	 <b>TX 20</b> E4 E5 E6 E7 E8 E10	 <b>119</b> -1,5 -3 -4
 <b>1995</b>	 <b>ITX 20</b> T8 T9 T10 T15 T20 T25 T27 T30 T40	 <b>600 H</b> -300
 <b>1990</b> -5 -10	 <b>142</b> 10 JC	 <b>2150</b> 4,5,5 6,5 8
 <b>2093 U</b> -10	 <b>8132</b> -160 JC	 <b>2160</b> PH 12
 <b>2087</b>	 <b>8250</b> -180 JC	

# S 1500 ES-02 MODULE ASSORTMENT MIDDLE

207 pieces





































- > Basic equipment for the commercial sector or ambitious do-it-yourselfers
- > Tools in metric sizes
- > Proved GEDORE ES tool modules from ABS
- > Suitable to fit in GEDORE tool trolley workster
- > For workbench 1504 models 0701, 0810, 1000, 1506 XL models 2511 and 2810
- > Also available in tool trolley 2004 0620





















































6,3  
1/4"  
12,5  
1/2"  
8  
5/16"



Contents		Code	No.
<b>1500 ES-1 B</b>	29.1	2319853	S 1500 ES-02
<b>1500 ES-6</b>			
<b>1500 ES-19 IS</b>			
<b>1500 ES-ITX 19 LKP</b>			
<b>1500 ES-IN 19 LKM</b>			
<b>1500 ES-1993 U-20</b>			
<b>1500 ES-20</b>			
<b>1500 ES-2133</b>			
<b>1500 ES-7 R</b>	117.1	2657708	1500 ES-02-2004
<b>1500 ES-145</b>			
<b>1500 ES-350</b>			
<b>1500 ES-711</b>			
<b>1500 ES-2150 PH</b>			
<b>1500 ES-K 1900</b>			
<b>1500 ES-8000</b>			
<b>1500 ED-70 K [6x]</b>			
<b>S 1500 ES-02</b>			
<b>+ 2004 0620</b>			

Contents	Contents
 <b>1 B</b> 6 7 8 9 10 11 12 13 14 15 16 17 18 19 20 21 22	 <b>2095</b>
 <b>42 2 (S/64AF)</b> 2,5 3 4 5 6 8 10	 <b>2098</b>
 <b>6</b> 6x7 8x9 10x11 12x13 14x15 16x17 18x19 20x22 21x23 24x27	 <b>20</b> 4 5 5,5 6 7 8 9 10 11 12 13 14
 <b>19</b> 10 11 12 13 14 15 16 17 18 19 21 22 23 24 26 27 28 30 32	 <b>IN 20</b> 3 4 5 6 8
 <b>IS 19</b> 10x1,6 12x2	 <b>TX 20</b> E4 E5 E6 E7 E8 E10
 <b>IKS 19</b> 2 3 4	 <b>ITX 20</b> T8 T9 T10 T15 T20 T25 T27 T30 T40
 <b>INX 19</b> 8 10	 <b>2133</b> 5,5 6 7 8 9 10
 <b>ITX 19</b> T20 T25 T27 T30 T40 T45 T50 T55 T60	 <b>7 R</b> 8 10 12 13 14 15 16 17 18 19
 <b>ITX 19 L</b> T20-100 T25-100 T27-100 T30-100 T40-100 T45-100 T50-100 T55-100 T60-100	 <b>142</b> 10 JC
 <b>708</b>	 <b>8132</b> -160 JC
 <b>IN 19</b> 5 6 7 8 9 10 12 14 17	 <b>8250</b> -180 JC
 <b>IN 19 L</b> 5-90 6-90 8-90 10-140 12-140 14-140	 <b>8316</b> -160 JC
 <b>1993 U-20</b>	 <b>97</b> -250
 <b>1987</b>	 <b>98</b> -125
 <b>1995</b>	 <b>99</b> 12-5
 <b>1990</b> -5 -10	 <b>100</b> -12
 <b>2093 U</b> -10	 <b>119</b> -1,5-3-4
 <b>2087</b>	
 <b>2090-4</b>	

Contents	Contents
 <b>600 H</b> -300	 <b>140</b>
 <b>140</b>	 <b>4534</b> -5
 <b>4534</b> -5	 <b>708</b>
 <b>708</b>	 <b>711</b>
 <b>711</b>	 <b>720</b>
 <b>720</b>	 <b>745</b>
 <b>745</b>	 <b>2150</b> 4,5,5,6,5,8
 <b>2150</b> 4,5,5,6,5,8	 <b>2160 PH</b> 1 2
 <b>2160 PH</b> 1 2	 <b>K 19</b> 10 13 14 17 19
 <b>K 19</b> 10 13 14 17 19	 <b>880</b> 7 8 9 12
 <b>880</b> 7 8 9 12	 <b>885</b> 5 6 8 10
 <b>885</b> 5 6 8 10	 <b>890</b> 1 2 3 4
 <b>890</b> 1 2 3 4	<b>KB 819</b>
<b>KB 819</b>	<b>K 1900</b>
<b>K 1900</b>	<b>8000 A</b> 1 2 21
<b>8000 A</b> 1 2 21	<b>8000 J</b> 1 2 21
<b>8000 J</b> 1 2 21	<b>1500 ED-70 K</b> [6x]
<b>1500 ED-70 K</b> [6x]	

Contents	Contents
 <b>600 H</b> -300	 <b>140</b>
 <b>140</b>	 <b>4534</b> -5
 <b>4534</b> -5	 <b>708</b>
 <b>708</b>	 <b>711</b>
 <b>711</b>	 <b>720</b>
 <b>720</b>	 <b>745</b>
 <b>745</b>	 <b>2150</b> 4,5,5,6,5,8
 <b>2150</b> 4,5,5,6,5,8	 <b>2160 PH</b> 1 2
 <b>2160 PH</b> 1 2	 <b>K 19</b> 10 13 14 17 19
 <b>K 19</b> 10 13 14 17 19	 <b>880</b> 7 8 9 12
 <b>880</b> 7 8 9 12	 <b>885</b> 5 6 8 10
 <b>885</b> 5 6 8 10	 <b>890</b> 1 2 3 4
 <b>890</b> 1 2 3 4	<b>KB 819</b>
<b>KB 819</b>	<b>K 1900</b>
<b>K 1900</b>	<b>8000 A</b> 1 2 21
<b>8000 A</b> 1 2 21	<b>8000 J</b> 1 2 21
<b>8000 J</b> 1 2 21	<b>1500 ED-70 K</b> [6x]
<b>1500 ED-70 K</b> [6x]	

# S 1500 ES-03 MODULE ASSORTMENT LARGE

325 pieces

- > Extensive industrial range for professionals
- > Tools in metric sizes
- > Proved GEDORE ES tool modules from ABS
- > For tool trolleys 2005 models 0810, 2004 models 0810, 1000
- > For workbench 1504 models 0810, 1000, 1504 XL, 1506 XL models 2511, 2810
- > Also available in tool trolley 2004 0810

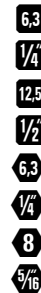

2004 0810

























Contents				Code	No.
1500 ES-1 B	1500 ES-400	8551-55	2319861	S 1500 ES-03	S 1500 ES-03
1500 ES-19 IS	1500 ES-6	H 42 KEL-88			
1500 ES-1993 U-20	1500 ES-7 R	H 43 KTX-07			
1500 ES-2	1500 ES-711	8728			
1500 ES-2 B	1500 ES-8000	60 P 8			
1500 ES-20	1500 ES-DT 42	137 10			
1500 CTD-20 BIT	1500 ES-IN 19 LKM	4615 3			
1500 ES-2133	1500 ES-ITX 19 LKP	0513-09			
1500 ES-2150 PH	1500 ES-K 1900	1940			
1500 ES-2163 TX	1500 ES-VDE 145				
1500 ES-34	1500 ES-VDE 2170 PZ				
1500 ES-350					
1500 ED-70 K [7x]					
S 1500 ES-03			2657716	1500 ES-03 2004	1500 ES-03 2004 0810
+ 2004 0810					





	Contents
	1 B 6 7 8 9 10 11 12 13 14 15 16 17 18 19 20 21 22
	42 2 (S/64AF) 2,5 3 4 5 6 8 10
	19 10 11 12 13 14 15 16 17 18 19 21 22 23 24 26 27 28 30 32
	IS 19 10x1,6 12x2
	IKS 19 2 3 4
	INX 19 8 10
	1993 U-20

	Contents
	1987
	1995
	1990 -5 -10
	2 6x7 8x9 10x11 12x13 14x15 16x17 18x19 20x22
	2 B 6x7 8x9 10x11 12x13 14x15 17x19
	2093 U -10
	2087

	Contents
	2090-4
	2095
	2098
	20 4 5 5,5 6 7 8 9 10 11 12 13 14
	IN 20 3 4 5 6 8
	TX 20 E4 E5 E6 E7 E8 E10
	ITX 20 T8 T9 T10 T15 T20 T25 T27 T30 T40

Contents	
	<b>20 L</b> 4,4,5 5 6 7 8 9 10 12 13
	<b>680</b> 4-25 5,5-25 6,5-25 8-25
	<b>685</b> 2,5-25 3-25 4-25 5-25 6-25
	<b>685 X</b> 5-25 6-25 8-25
	<b>687 TX</b> T6-25 T7-25 T8-25 T9-25 T10-25 T15-25 T20-25 T25-25 T27-25 T30-25 T40-25
	<b>690</b> 1-25 2-25 3-25
	<b>690 PZD</b> 1-25 2-25 3-25
	<b>673</b> 6,3
	<b>699</b>
	<b>620</b>
	<b>676</b>
	<b>639</b>
	TFK 649 E-649 F
	<b>2133</b> 5,5 6 7 8 9 10
	<b>2150</b> 4 5,5 6,5 8
	<b>2160 PH</b> 1 2
	<b>2163 TX</b> T8 T10 T15 T20 T25 T30
	<b>34</b> 8x9 10x11 12x13 14x15 16x17
	<b>97</b> -250
	<b>98</b> -125
	<b>99</b> 12-5
	<b>100</b> -12
	<b>119</b> -1,5 -3 -4
	<b>600 H</b> -300

Contents	
	<b>400</b> 8x10 10x11 12x14 17x19 13x15
	<b>6</b> 6x7 8x9 10x11 12x13 14x15 16x17 18x19 20x22 21x23 24x27
	<b>7 R</b> 8 10 12 13 14 15 16 17 18 19
	<b>140</b>
	<b>4534</b> -5
	<b>708</b>
	<b>711</b>
	<b>720</b>
	<b>745</b>
	<b>8000 A</b> 1 2 21
	<b>8000 J</b> 1 2 21
	<b>DT 2142</b> 2,2,5 3 4 5 6 7 8 10
	<b>IN 19</b> 5 6 7 8 9 10 12 14 17
	<b>IN 19 L</b> 5-90 6-90 8-90 10-140 12-140 14-140
	<b>ITX 19</b> T20 T25 T27 T30 T40 T45 T50 T55 T60
	<b>ITX 19 L</b> T20-100 T25-100 T27-100 T30-100 T40-100 T45-100 T50-100 T55-100 T60-100
	<b>708</b>
	<b>K 19</b> 10 13 14 17 19
	<b>880</b> 7 8 9 12
	<b>885</b> 5 6 8 10
	<b>890</b> 1 2 3 4
	<b>KB 819</b>
	<b>K 1900</b>
	<b>142</b> 10 C

Contents	
	<b>VDE 8250</b> -180 H
	<b>VDE 8132</b> -160 H
	<b>VDE 8314</b> -160 H
	<b>VDE 2170</b> 4,5,5 6,5 8
	<b>VDE 2160 PZ</b> 1 2
	<b>8551</b> 1 2 3 4 5
	<b>42 KEL</b> 2,2,5 3 4 5 6 8 10
	<b>43 KTX</b> T10 T15 T20 T25 T27 T30 T40
	<b>8728</b>
	<b>60 P</b> 8
	<b>137</b> 10
	<b>4615</b> 3
	<b>0513-09</b>
	<b>1940</b>
	<b>1500 ED-70 K</b> [7x]





# MODULE SYSTEM

## 1/3 ES MODULES FROM ABS PLASTIC



1500 ES-2 1500 ES-34 1500 ES-6 1500 ES-7 R 1500 ES-2133 1500 ES-145 1500 ES-350 1500 ES-711 1500 ES-1993 U-20 1500 ES-19 1500 ES-IN 19 LKM 1500 ES-19 IS 1500 ES-ITX 19 LKP 1500 ES-1 07 1500 ES 1993 T 1500 ES-20  
 1500 ES-30 1500 ES-ITX 30 1500 ES-K 1900 1500 ES-VDE 2170 PZ 1500 ES-VDE 145 1500 ES-2150 PH 1500 ES-2150 PZ 1500 ES-2163 BTX 1500 ES-2163 TXB 1500 ES-K 19L 1500 ES-8000 1500 ES-400 1500 ES-2B 1500 ES-534 1500 E-SL 1500 E-N-L

## 1/3 CT MODULES FROM 2-COLOUR FOAM



1500 CT1-2 1500 CT1-34 1500 CT1-6 1500 CT1-7 R 1500 CT1-2133 1500 CT1-142 1500 CT1-350 1500 CT1-711 1500 CT1-1993 U-20 1500 CT1-19 1500 CT1-D 19 1500 CT1-19 IS 1500 CT1-ITX 19 LKP 1500 CT1-1993 T  
 1500 CT1-IN 19 LKM 1500 CT1-20 1500 CT1-30 1500 CT1-ITX 30 1500 CT1-VDE 2170 PZ 1500 CT1-VDE 142 1500 CT1-2150 PH 1500 CT1-2150 PZ 1500 CT1-2163 BTX 1500 CT1-K 1900 1500 CT1-8000 1500 CT1-400 1500 CT1-534

## 2/3 ES MODULES FROM ABS PLASTIC



1500 ES-7 1500 ES-1 B 1500 ES-DT 42 1500 ES-7-32

## 2/3 CT MODULES FROM 2-COLOUR FOAM

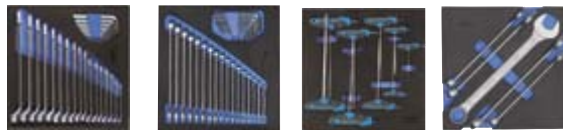

1500 CT2-1-B 1500 CT2-7 1500 CT2-DT 42 1500 CT2-7-32

## DISTANCE MODULES



1500 ED-30

1500 ED-70

1500 ED-70 K

1500 ED-70 XL

1500 ES-20 BIT

1500 ED-150 K

1500 ED-85

### CT MODULES 2005 CT FOR VOLUME DRAWERS

> 112

#### In 2 sizes:

- > CT4 = 1/1 drawer 2005 (633 x 390 x 35 mm)
- > CT2 = 1/2 drawer 2005 (316.5 x 390 x 35 mm)
- > CT4 suitable for 2005, 1504 XL, 2430
- > CT2 suitable for 1506 XL, 1504 and 2004



# TOOL MODULES

- > For keeping order in the GEDORE tool trolleys and mobile workbenches with variable drawer divisions
- > Dimensions:  
1/3 module = W 157.5 x D 310 mm  
2/3 module = W 315.0 x D 310 mm
- > For models 1502, 1504, 1506 XL, 2004, 2500 please order distance module 1500 ED-70 or 1500 ED-70 K additionally
- > For model 1505 please order 1500 ED-70 or 1500 ED-70 K as well as 1500 ED-150 K additionally
- > For model 2005 and 1504 XL please order 1500 ED-70 XL additionally

## ES Modules 1500 ES

- > From impact-resistant ABS
- > Resistant to oil and acids
- > Each tool is securely held in its own pocket, prevented from slipping and protected from damage
- > Grip recesses facilitate removal of the tools

## CT-Module 1500 CT

- > 2-colour foam insert provides easy optical check of completeness
- > Particularly suited for work in sensitive areas, in which it must be assured that no tools are left behind.
- > Underlay blue, overlay black. A visible blue pocket indicates a missing tool
- > Each tool is securely held in its own pocket, prevented from slipping and protected from damage
- > Grip recesses facilitate removal of the tools
- > Clearly visible tool contours simplify replacement into the correct pocket
- > Resistant to oil and grease
- > Easy to clean with water, soap and a nailbrush



## POSSIBLE COMBINATIONS OF THE MODULES

1578, 1580, 2525



1578

1580

2525

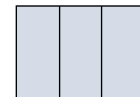

3x 1/3 modules



1x 2/3 modules  
and  
1x 1/3 module

2004, 1502, 1504,  
1506 XL



1504

2004

1502

1506 XL

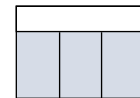

3x 1/3 modules  
3x distance  
module  
1500 ED-70 K\*

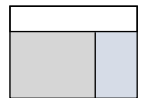

1x 2/3 modules  
and  
1x 1/3 module  
3x distance module  
1500 ED-70 K\*

WSL-L7, 2005,  
1504 XL



WSL-L7

2005

1504 XL

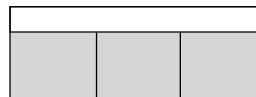

XL drawer 3x 2/3 modules  
2x distance modules 1500 ED-70  
or 1500 ED-70 K

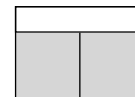

2x 2/3 modules  
1x distance modu-  
le 1500 ED-70 XL

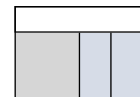

1x 2/3 and  
2x 1/3 modules  
1x distance module  
1500 ED-70 XL

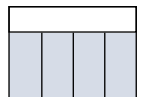

4x 1/3 modules  
1x distance  
module  
1500 ED-70 XL

B 1500 L, 1505



1505

B 1500 L

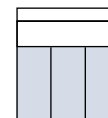

3x 1/3 modules  
1x distance module  
1500 ED-150 K  
1x distance module  
1500 ED-70

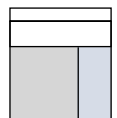

1x 2/3 and  
1x 1/3 modules  
1x distance module  
1500 ED-150 K  
1x distance module  
1500 ED-70

\*When ordering model 2004, 1502 or 1504 2 pieces of 1500 ED-70 K are supplied f.o.c.

## 1500 ES-1 B COMBINATION SPANNER SET

in 2/3 ES tool module



Contents		Code	No.
1 B 6 7 8 9 10 11 12 13 14 15 16 17 18 19 20 21 22 PH 42-88 (2 2,5 3 4 5 6 8 10)	2.790	6612280	1500 ES-1 B

Description		Code	No.
<b>ES tool module empty</b>	0.250	5620330	1500 E-1B-7 L

## 1500 ES-2 RING SPANNER SET

in 1/3 ES tool module



Contents		Code	No.
2 6x7 8x9 10x11 12x13 14x15 16x17 18x19 20x22	1.616	6621190	1500 ES-2

Description		Code	No.
<b>ES tool module empty</b>	0.250	5626290	1500 E-2 L

## 1500 ES-2 B RING SPANNER SET, SHORT PATTERN

in 1/3 ES tool module



Contents		Code	No.
2 B 6x7 8x9 10x11 12x13 14x15 17x19	0.630	1731165	1500 ES-2 B

Description		Code	No.
<b>ES tool module empty</b>	0.120	1731173	1500 E-2B-400 L

## 1500 ES-400 SET OF OPEN FLARE NUT SPANNERS

in 1/3 ES tool module



Contents		Code	No.
400 8x10 10x11 12x14 13x15 17x19	0.824	1731157	1500 ES-400

Description		Code	No.
<b>ES tool module empty</b>	0.120	1731173	1500 E-2B-400 L

## 1500 ES-6 OPEN ENDED SPANNER SET

in 1/3 ES tool module



Contents		Code	No.
6 6x7 8x9 10x11 12x13 14x15 16x17 18x19 20x22 21x23 24x27	1.702	6621000	1500 ES-6

Description		Code	No.
<b>ES tool module empty</b>	0.250	5626100	1500 E-6-7R L

## 1500 ES-7 COMBINATION SPANNER SET

in 2/3 ES tool module



Contents		Code	No.
7 6 7 8 9 10 11 12 13 14 15 16 17 18 19 20 21 22 PH 42-88 (2 2,5 3 4 5 6 8 10)	2.232	6612520	1500 ES-7

Description		Code	No.
<b>ES tool module empty</b>	0.250	5620330	1500 E-1B-7 L

## 1500 ES-7-32 COMBINATION SPANNER SET

in 2/3 ES tool module



Contents		Code	No.
7 23 24 27 30 32	2.348	1761145	1500 ES-7-32
Description		Code	No.
ES tool module empty	0.340	1761153	1500 E-7-32 L

## 1500 ES-7 R COMBINATION RATCHET SPANNER SET

in 1/3 ES tool module



Contents		Code	No.
7 R 8 10 12 13 14 15 16 17 18 19	1.500	2305429	1500 ES-7 R
Description		Code	No.
ES tool module empty	0.250	5626100	1500 E-6-7R L

## 1500 ES-34 SWIVEL HEAD WRENCH SET

in 1/3 ES tool module



Contents		Code	No.
34 8x9 10x11 12x13 14x15 16x17	1.272	6605070	1500 ES-34
Description		Code	No.
ES tool module empty	0.150	5622890	1500 E-34 L

## 1500 ES-534 SET COMBINATION SWIVEL HEAD WRENCHES

in 1/3 ES tool module



Contents		Code	No.
534 10 11 13 14 15 17 19 26 RS 1 2	1.614	1813196	1500 ES-534
Description		Code	No.
ES tool module empty	0.140	1813226	1500 E-534 L

## 1500 ES-2133 SOCKET WRENCH SET

in 1/3 ES tool module



Contents		Code	No.
2133 5,5 6 7 8 9 10	1.038	1751239	1500 ES-2133
Description		Code	No.
ES tool module empty	0.140	2823829	1500 E-2133 L

## 1500 ES-20 SOCKET SET 1/4"

in 1/3 ES tool module



Contents		Code	No.
20 4 5 5,5 6 7 8 9 10 11 12 13 14	1.066	6626230	1500 ES-20
IN 20 3 4 5 6 8			
ITX 20 T8 T9 T10 T15 T20 T25 T27 T30 T40			
TX 20 E4 E5 E6 E7 E8 E10			
2087 2090-4 2095 2098 2093 U-10			
Description		Code	No.
ES tool module empty	0.140	5621490	1500 E-20 L

## 1500 ES-30 SOCKET SET 3/8"

in 1/3 ES tool module



Contents	kg	Code	No.
30 6 7 8 9 10 11 12 13 14 15 16 17 18 19	1.830	6626070	1500 ES-30
IN 30 4 5 6 8 10			
3095 3087 3090-5 -10 3093 U-10			

Description	kg	Code	No.
ES tool module empty	0.140	5621220	1500 E-30 L

10  
3/8"

## 1500 ES-ITX 30 SCREWDRIVER BIT SOCKET SET 3/8"

in 1/3 ES tool module



Contents	kg	Code	No.
IN 30 L 4 5 6 7 8 10	2.346	1640860	1500 ES-ITX 30
ITX 30 T20 T25 T27 T30 T40 T45 T50			
ITX 30 L T20 T25 T27 T30 T40 T45 T50			
TX 30 E5 E6 E7 E8 E10 E11 E12 E14			
IS 30 5,5 6,5 8 10 12			
IKS 30 1 2 3			
IKS 30 PZD 1 2 3			

Description	kg	Code	No.
ES tool module empty	0.140	1643363	1500 E-ITX 30 L

10  
3/8"

## 1500 ES-19 SOCKET SET 1/2", HEXAGON

in 1/3 ES tool module

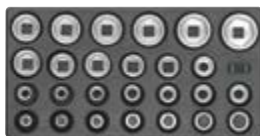

Contents	kg	Code	No.
19 10 11 12 13 14 15 16 17 18 19 21 22 23 24 26 27 28 30 32	2.956	6626580	1500 ES-19
IN 19 6 7 8 9 10 12 14			

Description	kg	Code	No.
ES tool module empty	0.140	5621650	1500 E-19 L

12.5  
1/2"

## 1500 ES-D 19 SOCKET SET 1/2", UD PROFILE

in 1/3 ES tool module



Contents	kg	Code	No.
D 19 10 11 12 13 14 15 16 17 18 19 21 22 23 24 26 27 28 30 32	2.900	1899694	1500 ES-D 19
IN 19 6 7 8 9 10 12 14			

Description	kg	Code	No.
ES tool module empty	0.140	5621650	1500 E-19 L

12.5  
1/2"

## 1500 ES-19 IS SOCKET SET 1/2"

in 1/3 ES tool module



Contents	kg	Code	No.
19 10 11 12 13 14 15 16 17 18 19 21 22 23 24 26 27 28 30 32	2.984	1733109	1500 ES-19 IS
IS 19 10x1,6 12x2			
IKS 19 2 3 4			
INX 19 8 10			

Description	kg	Code	No.
ES tool module empty	0.140	5621650	1500 E-19 L

12.5  
1/2"

## 1500 ES-IN 19 LKM SCREWDRIVER BIT SOCKET SET 1/2"

in 1/3 ES tool module



Contents	kg	Code	No.
IN 19 5 6 7 8 9 10 12 14 17	2.124	1402234	1500 ES-IN 19 LKM
IN 19 L 5-90 6-90 8-90 10-140 12-140 14-140			

Description	kg	Code	No.
ES tool module empty	0.150	1402714	1500 E-IN 19 LKM

12.5  
1/2"

## 1500 ES-ITX 19 LKP SCREWDRIVER BIT SOCKET SET 1/2"

in 1/3 ES tool module



Contents	kg	Code	No.
ITX 19 T20 T25 T27 T30 T40 T45 T50 T55 T60	2.156	1402226	1500 ES-ITX 19 LKP
ITX 19 L T20-100 T25-100 T27-100 T30-100 T40-100 T45-100 T50-100 T55-100 T60-100			708

Description	kg	Code	No.
ES tool module empty	0.150	1402706	1500 E-ITX 19 LKP

## 1500 ES-1993 U-20 ACCESSORIES FOR SOCKET WRENCHES 1/2"

in 1/3 ES tool module



Contents	kg	Code	No.
1993 U-20 1987 1995 1990-5 -10	1.191	1550756	1500 ES-1993 U-20

Description	kg	Code	No.
ES tool module empty	0.140	5621810	1500 E-1993 L

## 1500 ES-1993 T ACCESSORIES FOR SOCKET WRENCHES 1/2"

in 1/3 ES tool module



Contents	kg	Code	No.
1993 U-10 T 1987 1995 1990-5 -10	1.984	6626740	1500 ES-1993 T

Description	kg	Code	No.
ES tool module empty	0.140	5621810	1500 E-1993 L

## 1500 ES-K 19 L SET IMPACT SOCKETS 1/2"

in 1/3 ES tool module



Contents	kg	Code	No.
K 19 L 10 13 14 16 17 18 19 21 22 23 24 27	3.394	1640836	1500 ES-K 19 L

Description	kg	Code	No.
ES tool module empty	0.120	1643371	1500 E-K 19 L L

## 1500 ES-K 1900 IMPACT DRIVER SET

in 1/3 ES tool module



Contents	kg	Code	No.
K 19 10 13 14 17 19 880 7 8 9 12 885 5 6 8 10 890 1 2 3 4 KB 819 K 1900	1.900	1402242	1500 ES-K 1900

Description	kg	Code	No.
ES tool module empty	0.150	1402722	1500 E-K 1900 L

## 1500 ES-DT 2142 HEXAGON SOCKET KEY SET

in 2/3 ES tool module



Contents	kg	Code	No.
DT 2142 2,5 3 4 5 6 7 8 10	1.337	1543474	1500 ES-DT 2142

Description	kg	Code	No.
ES tool module empty	0.270	1543490	1500 E-DT 2142 L



## 1500 ES-2150 PH SCREWDRIVER SET

in 1/3 ES tool module



Contents		Code	No.
⊖ 2150 4 5,5 6,5 8 ⊕ 2160 PH 1 2	0.820	1523708	1500 ES-2150 PH

Description		Code	No.
ES tool module empty	0.140	2823829	1500 E-2133 L

## 1500 ES-2150 PZ SCREWDRIVER SET

in 1/3 ES tool module



Contents		Code	No.
⊖ 2150 4 5,5 6,5 8 ⊕ 2160 PZ 1 2	0.846	1523694	1500 ES-2150 PZ

Description		Code	No.
ES tool module empty	0.140	2823829	1500 E-2133 L

## 1500 ES-2163 TX SCREWDRIVER SET

in 1/3 ES tool module



Contents		Code	No.
⊕ 2163 TX T8 T10 T15 T20 T25 T30	0.638	1582666	1500 ES-2163 TX

Description		Code	No.
ES tool module empty	0.140	2823829	1500 E-2133 L

## 1500 ES-2163 TXB SCREWDRIVER SET

in 1/3 ES tool module



Contents		Code	No.
⊕ 2163 TXB T10 T15 T20 T25 T30 T40	0.724	1616625	1500 ES-2163 TXB

Description		Code	No.
ES tool module empty	0.140	2823829	1500 E-2133 L

## 1500 ES-VDE 2170 PZ VDE SCREWDRIVER SET

in 1/3 ES tool module



Contents		Code	No.
⊖ VDE 2170 4 5,5 6,5 8 ⊕ VDE 2160 PZ 1 2	0.846	1733095	1500 ES-VDE 2170 PZ

Description		Code	No.
ES tool module empty	0.140	2823829	1500 E-2133 L

## 1500 ES-145 PLIERS SET

in 1/3 ES tool module



Contents		Code	No.
142 10 JC 8250-180 JC 8132-160 JC 8316-160 JC	1.400	6614650	1500 ES-145

Description		Code	No.
ES tool module empty	0.140	5620840	1500 E-145 L

## 1500 ES-VDE 145 VDE PLIERS SET

in 1/3 ES tool module



Contents	kg	Code	No.
<b>142 10 C</b> <b>VDE 8250-180 H VDE 8132-160 H VDE 8314-160 H</b>	1.320	1733079	1500 ES-VDE 145

Description	kg	Code	No.
<b>ES tool module empty</b>	0.140	5620840	1500 E-145 L

## 1500 ES-8000 CIRCLIP PLIERS

in 1/3 ES tool module



Contents	kg	Code	No.
<b>8000 A 1 8000 A 2 8000 A 21</b> <b>8000 J 1 8000 J 2 8000 J 21</b>	1.136	1402196	1500 ES-8000

Description	kg	Code	No.
<b>ES tool module empty</b>	0.150	1446479	1500 E-8000 L

## 1500 ES-137 GRIP WRENCH SET

in 1/3 ES tool module



Contents	kg	Code	No.
<b>137 7 137 10</b> <b>137 KR-7</b> <b>138 Y</b>	1.970	2188198	1500 ES-137

Description	kg	Code	No.
<b>ES tool module empty</b>	0.140	2188139	1500 E-137 L

## 1500 ES-350 CHISEL SET

in 1/3 ES tool module



Contents	kg	Code	No.
<b>97-250 98-125 99 12-5 100-12</b> <b>119-1,5 3 4</b> <b>600 H-300</b>	1.818	6613760	1500 ES-350

Description	kg	Code	No.
<b>ES tool module empty</b>	0.140	5620680	1500 E-350 L

## 1500 ES-711 PRECISION MECHANICS

in 1/3 ES tool module



Contents	kg	Code	No.
<b>140</b> <b>4534-5</b> <b>708 711 720 745</b>	0.972	1402218	1500 ES-711

Description	kg	Code	No.
<b>ES tool module empty</b>	0.150	1402692	1500 E-711 L

## 1500 ES-1.07 PULLER SET

in 1/3 ES tool module

> **Contents:** 1 cross-beam each 2- and 3-arm pattern (clamping reach 90 mm), 1 spindle, and 3 slim quick-release pulling legs (clamping depth 100 mm)



Contents	kg	Code	No.
<b>1x 106/103 1x 107/103</b> <b>1x 1.1406140</b> <b>3x 106/S100-E</b>	1.980	1933213	1500 ES-1.07

Description	kg	Code	No.
<b>ES tool module empty</b>	0.200	1933248	1500 E-1.07 L

## 1500 E-N L TOOL MODULE EMPTY

- > Impact resistant ABS, black grained
- > Dimensions: W 157.5 x D 310 mm (1/3 module)



W	D	H		Code	No.
158	310	42	0.250	5622540	1500 E-N L

## 1500 E-S L TOOL MODULE EMPTY

- > With compartments for small parts
- > Impact resistant ABS, black grained
- > Dimensions:  
W 157.5 x D 310 mm  
(1/3 module)



W	D	H		Code	No.
158	310	42	0.150	1879227	1500 E-S L

## 1500 ED-30 DISTANCE MODULE EMPTY

- > For fixing modules 1500 ES in drawer sizes W 480 x D 350 mm
- > Impact resistant ABS, black grained
- > Dimensions: W 157 x D 30 x H 42 mm



W	D	H		Code	No.
157	30	42	0.030	5626370	1500 ED-30

## 1500 ED-70 DISTANCE MODULE WITH SMALL BOXES

- > For fixing modules 1500 ES in drawer sizes W 480 x L 400 mm of tool trolley 2004 and workbenches 1502, 1504, 1505 and 1506 XL
- > Module in sheet steel containing four practical transparent plastic boxes for small parts, lid easily removable, execution L without boxes
- > Dimensions: W 475 x D 77 x H 40 mm



W	D	H		Code	No.
475	77	40	0.900	6627120	1500 ED-70
475	77	40	0.750	5627930	1500 ED-70 L

## 1500 ED-70 K DISTANCE MODULE EMPTY

- > For fixing modules 1500 ES in drawers with depth 400 mm of tool trolley 2004 and workbenches 1502, 1504, 1505 and 1506 XL
- > Impact resistant ABS, black grained
- > Dimensions: W 475 x D 77 x H 40 mm



W	D	H		Code	No.
475	77	40	0.120	1618687	1500 ED-70 K

## 1500 ED-70 S DISTANCE MODULE 1/3 EMPTY

- > For tool trolley workster and 2005, workbench 1504 XL and tool chest 2430, suitable as distance piece for module 1/3
- > Module in sheet steel
- > Dimensions: W 152 x D 77 x H 40 mm



W	D	H		Code	No.
152	77	40	0.150	1851462	1500 ED-70 S

## 1500 ED-70 XL DISTANCE MODULE EMPTY

- > Suitable to take torque wrenches and other long hand tools or small pieces
- > For tool trolley workster and 2005, workbench 1504 XL and tool chest 2430
- > Module in sheet steel
- > Dimensions: W 625 x D 77 x H 40 mm



W	D	H		Code	No.
625	77	40	0.854	1803069	1500 ED-70 XL

## 1500 ED-85

### DISTANCE MODULE EMPTY

- > Module in sheet steel
- > Dimensions: W 538 x D 85 x H 40 mm



W	D	H		Code	No.
538	85	40	0.845	1972588	1500 ED-85

## 1500 ED-150 K

### DISTANCE MODULE EMPTY

- > Suitable to take torque wrenches and other long hand tools or small pieces
- > Impact resistant ABS, black grained
- > Dimensions: W 480 x D 150 x H 42 mm



W	D	H		Code	No.
480	150	42	0.150	1879243	1500 ED-150 K



## CT Tool Modules

## 1500 CT2-1 B

### COMBINATION SPANNER SET

in 2/3 CT tool module



Contents		Code	No.
 1 B 6 7 8 9 10 11 12 13 14 15 16 17 18 19 20 21 22	2.385	2308819	1500 CT2-1 B
● PH 42-88 (2 2,5 3 4 5 6 8 10)			



Description		Code	No.
CT module empty	0.070	2322277	EI-1500 CT2-1B L

## 1500 CT1-2

### RING SPANNER SET

in 1/3 CT tool module



Contents		Code	No.
 2 6x7 8x9 10x11 12x13 14x15 16x17 18x19 20x22	1.360	2308827	1500 CT1-2



Description		Code	No.
CT module empty	0.050	2322285	EI-1500 CT1-2 L

## 1500 CT1-2 B

### RING SPANNER SET, SHORT PATTERN

in 1/3 CT tool module



Contents		Code	No.
 2 B 6x7 8x9 10x11 12x13 14x15 17x19	0.376	2308843	1500 CT1-2 B



Description		Code	No.
CT module empty	0.050	2322293	EI-1500 CT1-2B L

## 1500 CT1-400

### SET OF OPEN FLARE NUT SPANNERS

in 1/3 CT tool module



Contents		Code	No.
 400 8x10 10x11 12x14 13x15 17x19	0.565	2309068	1500 CT1-400

Description		Code	No.
CT module empty	0.050	2324210	EI-1500 CT1-400 L

## 1500 CT1-6

### OPEN ENDED SPANNER SET

in 1/3 CT tool module

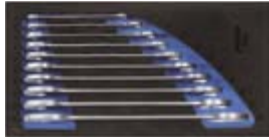

Contents		Code	No.
6 6x7 8x9 10x11 12x13 14x15 16x17 18x19 20x22 21x23 24x27	1.440	2308851	1500 CT1-6
Description		Code	No.
CT module empty	0.050	2322307	EI-1500 CT1-6 L

## 1500 CT2-7

### COMBINATION SPANNER SET

in 2/3 CT tool module



Contents		Code	No.
7 6 7 8 9 10 11 12 13 14 15 16 17 18 19 20 21 22 ● PH 42-88 (2 2,5 3 4 5 6 8 10)	1.750	2308878	1500 CT2-7
Description		Code	No.
CT module empty	0.070	2324164	EI-1500 CT2-7 L

## 1500 CT2-7-32

### COMBINATION SPANNER SET

in 2/3 CT tool module

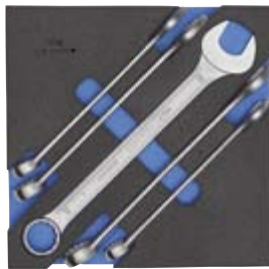

Contents		Code	No.
7 23 24 27 30 32	1.865	2308886	1500 CT2-7-32
Description		Code	No.
CT module empty	0.070	2324172	EI-1500 CT2-7-32 L

## 1500 CT1-7 R

### COMBINATION RATCHET SPANNER SET

in 1/3 CT tool module

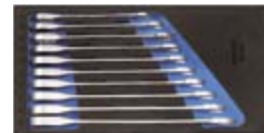

Contents		Code	No.
7 R 8 10 12 13 14 15 16 17 18 19	1.240	2308894	1500 CT1-7 R
Description		Code	No.
CT module empty	0.050	2322315	EI-1500 CT1-7R-URL

## 1500 CT1-7 UR

### COMBINATION RATCHET SPANNER SET

in 1/3 CT tool module

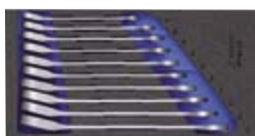

Contents		Code	No.
7 UR 8 10 12 13 14 15 16 17 18 19	1.245	2331969	1500 CT1-7 UR
Description		Code	No.
CT module empty	0.050	2322315	EI-1500 CT1-7R-URL

## 1500 CT1-7 RA

### COMBINATION RATCHET SPANNER SET

in 1/3 CT tool module



Contents		Code	No.
7 R 8 10 12 13 14 15 16 17 18 19 7 RA-12,5 -10 -6,3 7 RB-6,3	1.270	2327686	1500 CT1-7 RA
Description		Code	No.
CT module empty	0.050	2327708	EI-1500 CT1-7RA-URL



## 1500 CT1-7 URA COMBINATION RATCHET SPANNER SET

in 1/3 CT tool module



Schlüsselkammer  
R-Serie



Contents	kg	Code	No.
7 UR 8 10 12 13 14 15 16 17 18 19 7 RA-12,5 -10 -6,3 7 RB-6,3	1.280	2327678	1500 CT1-7 URA

Description	kg	Code	No.
CT module empty	0.050	2327708	EI-1500 CT1-7RA-URA L

## 1500 CT1-34 SWIVEL HEAD WRENCH SET

in 1/3 CT tool module



Contents	kg	Code	No.
34 8x9 10x11 12x13 14x15 16x17	1.035	2308991	1500 CT1-34

Description	kg	Code	No.
CT module empty	0.050	2322404	EI-1500 CT1-34 L

## 1500 CT1-534 SET COMBINATION SWIVEL HEAD WRENCHES

in 1/3 CT tool module



Contents	kg	Code	No.
534 10 11 13 14 15 17 19 26 RS 1 2	1.405	2309076	1500 CT1-534

Description	kg	Code	No.
CT module empty	0.050	2322455	EI-1500 CT1-534 L

## 1500 CT1-2133 SOCKET WRENCH SET

in 1/3 CT tool module

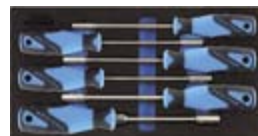

Contents	kg	Code	No.
2133 5,5 6 7 8 9 10	0.820	2309122	1500 CT1-2133

Description	kg	Code	No.
CT module empty	0.050	2322501	EI-1500 CT1-2133 L

## 1500 CT1-20 SOCKET SET 1/4"

in 1/3 CT tool module

6.3  
1/4"



Contents	kg	Code	No.
20 4 5 5,5 6 7 8 9 10 11 12 13 14 IN 20 3 4 5 6 8 ITX 20 T8 T9 T10 T15 T20 T25 T27 T30 T40 TX 20 E4 E5 E6 E7 E8 E10 2087 2090-4 2095 2098 2093 U-10	0.845	2308967	1500 CT1-20

Description	kg	Code	No.
CT module empty	0.050	2322374	EI-1500 CT1-20 L

## 1500 CTD-20 BIT TOOL MODULE 1/4"

with assortment



- > Only suitable for tool trolley 2004, and workbenches 1502, 1504, 1505 and 1506 XL
- > For models 2005, workster, 2430 and 1504 XL with distance module 1500 ED-70 S
- > Dimensions: W 475 x D 77 x H 40 mm



Contents	kg	Code	No.
<ul style="list-style-type: none"> <li>○ 20 L 4 4,5 5 6 7 8 9 10 12 13</li> <li>○ 680 4 5,5 6,5 8</li> <li>● 685 2,5 3 4 5 6</li> <li>● 685 X 5 6 8</li> <li>⊕ 687 TX T6 T7 T8 T9 T10 T15 T20 T25 T27 T30 T40</li> <li>⊕ 690 1 2 3</li> <li>⊕ 690 PZD 1 2 3</li> </ul>	0.700	1733419	1500 CTD-20 BIT
649 673 6,3 699 620 676 639			

## 1500 CT1-30 SOCKET SET 3/8"

in 1/3 CT tool module



Contents	kg	Code	No.
<ul style="list-style-type: none"> <li>⊖ 30 6 7 8 9 10 11 12</li> <li>13 14 15 16 17 18 19</li> <li>● IN 30 4 5 6 8 10</li> <li>3095 3087 3090-5 -10</li> <li>3093 U-10</li> </ul>	1.670	2308975	1500 CT1-30

Description	kg	Code	No.
CT module empty	0.050	2322382	EI-1500 CT1-30 L

## 1500 CT1-ITX 30 SCREWDRIVER BIT SOCKET SET 3/8"

in 1/3 CT tool module



Contents	kg	Code	No.
<ul style="list-style-type: none"> <li>● IN 30 L 4 5 6 7 8 10</li> <li>⊕ ITX 30 T20 T25 T27 T30 T40 T45 T50</li> <li>⊕ ITX 30 L T20 T25 T27 T30 T40 T45 T50</li> <li>⊕ TX 30 E5 E6 E7 E8 E10 E11 E12 E14</li> <li>○ IS 30 5,5 6,5 8 10 12</li> <li>⊕ IKS 30 1 2 3</li> <li>⊕ IKS 30 PZD 1 2 3</li> </ul>	2.175	2308983	1500 CT1-ITX 30

Description	kg	Code	No.
CT module empty	0.050	2322390	EI-1500 CT1-ITX30 L

## 1500 CT1-19 SOCKET SET 1/2", HEXAGON

in 1/3 CT tool module



Contents	kg	Code	No.
<ul style="list-style-type: none"> <li>⊖ 19 10 11 12 13 14 15 16 17 18</li> <li>19 21 22 23 24 26 27 28 30 32</li> <li>● IN 19 6 7 8 9 10 12 14</li> </ul>	2.790	2308908	1500 CT1-19

Description	kg	Code	No.
CT module empty	0.047	2322323	EI-1500 CT1-19 L

## 1500 CT1-D 19 SOCKET SET 1/2", UD PROFILE

in 1/3 CT tool module



Contents	kg	Code	No.
<ul style="list-style-type: none"> <li>⊖ D 19 10 11 12 13 14 15 16 17 18 19 21 22 23 24 26 27 28 30 32</li> <li>● IN 19 6 7 8 9 10 12 14</li> </ul>	2.680	2308916	1500 CT1-D 19

Description	kg	Code	No.
CT module empty	0.047	2322323	EI-1500 CT1-19 L

## 1500 CT1-19 IS SOCKET SET 1/2"

in 1/3 CT tool module



Contents		Code	No.
<ul style="list-style-type: none"> <li>19 10 11 12 13 14 15 16 17 18 19 21</li> <li>22 23 24 26 27 28 30 32</li> <li>IS 19 10x1,6 12x2</li> <li>IKS 19 2 3 4</li> <li>INX 19 8 10</li> </ul>	2.765	2308924	1500 CT1-19 IS

Description		Code	No.
CT module empty	0.050	2322331	EI-1500 CT1-19 IS L

## 1500 CT1-INX 19 LK SCREWDRIVER BIT SOCKET SET 1/2"

in 1/3 CT tool module



Contents		Code	No.
<ul style="list-style-type: none"> <li>INX 19 8 10 12 14 16 18</li> <li>INX 19 L 6-100 8-100 10-100 12-100 14-100</li> </ul>	1.044	2957957	1500 CT1-INX 19 LK

Description		Code	No.
CT module empty	0.050	2957949	EI-1500 CT1-INX 19 LK

## 1500 CT1-1993 U-20 ACCESSORIES FOR SOCKET WRENCHES 1/2"

in 1/3 CT tool module



Contents		Code	No.
<ul style="list-style-type: none"> <li>1993 U-20</li> <li>1987 1995</li> <li>1990-5 -10</li> </ul>	1.700	2309114	1500 CT1-1993 U-20

Description		Code	No.
CT module empty	0.050	2322498	EI-1500 CT1-1993 L

## 1500 CT1-IN 19 LKM SCREWDRIVER BIT SOCKET SET 1/2"

in 1/3 CT tool module



Contents		Code	No.
<ul style="list-style-type: none"> <li>IN 19 5 6 7 8 9 10 12 14 17</li> <li>IN 19 L 5-90 6-90 8-90 10-140 12-140 14-140</li> </ul>	1.900	2308932	1500 CT1-IN 19 LKM

Description		Code	No.
CT module empty	0.050	2957647	EI-1500 CT1-IN 19 LKM

## 1500 CT1-ITX 19 LKP SCREWDRIVER BIT SOCKET SET 1/2"

in 1/3 CT tool module



Contents		Code	No.
<ul style="list-style-type: none"> <li>ITX 19 T20 T25 T27 T30 T40 T45 T50 T55 T60</li> <li>ITX 19 L T20-100 T25-100 T27-100 T30-100 T40-100 T45-100 T50-100 T55-100 T60-100 708</li> </ul>	1.915	2308940	1500 CT1-ITX 19 LKP

Description		Code	No.
CT module empty	0.050	2322366	EI-1500 CT1-ITX19LKP L

## 1500 CT1-1993 T ACCESSORIES FOR SOCKET WRENCHES 1/2"

in 1/3 CT tool module



Contents		Code	No.
<ul style="list-style-type: none"> <li>1993 U-10 T</li> <li>1987 1995</li> <li>1990-5 -10</li> </ul>	1.765	2309106	1500 CT1-1993 T

Description		Code	No.
CT module empty	0.050	2322498	EI-1500 CT1-1993 L

## 1500 CT1-K 1900 IMPACT DRIVER SET

in 1/3 CT tool module



Contents		Code	No.
○ K 19 10 13 14 17 19	2.645	2309092	1500 CT1-K 1900
○ K 19 LS 17 19 21 22			
⊖ 880 7 8 9 12			
● 885 5 6 8 10			
⊕ 890 1 2 3 4			
KB 819 K 1900			

Description		Code	No.
CT module empty	0.050	2322471	EI-1500 CT1-K1900 L



## 1500 CT2-DT 2142 HEXAGON SOCKET KEY SET

in 2/3 CT tool module

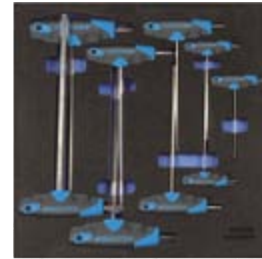

Contents		Code	No.
● DT 2142 2,5 3 4 5 6 7 8 10	0.900	2309009	1500 CT2-DT 2142

Description		Code	No.
CT module empty	0.070	2322412	EI-1500 CT2-DT2142

## 1500 CT1-2150 PH SCREWDIVER SET

in 1/3 CT tool module

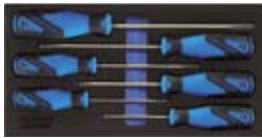

Contents		Code	No.
⊖ 2150 4 5,5 6,5 8	0.630	2309130	1500 CT1-2150 PH
⊕ 2160 PH 1 2			

Description		Code	No.
CT module empty	0.050	2322528	EI-1500 CT1-2150 L

## 1500 CT1-2150 PZ SCREWDIVER SET

in 1/3 CT tool module



Contents		Code	No.
⊖ 2150 4 5,5 6,5 8	0.630	2309149	1500 CT1-2150 PZ
⊕ 2160 PZ 1 2			

Description		Code	No.
CT module empty	0.050	2322528	EI-1500 CT1-2150 L

## 1500 CT1-2163 TX SCREWDIVER SET

in 1/3 CT tool module

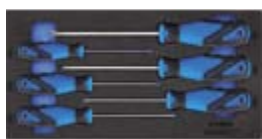

Contents		Code	No.
● 2163 TX T8 T10 T15 T20 T25 T30	0.400	2309157	1500 CT1-2163 TX

Description		Code	No.
CT module empty	0.050	2322544	EI-1500 CT1-2163TX L

## 1500 CT1-2163 TXB SCREWDIVER SET

in 1/3 CT tool module



Contents		Code	No.
● 2163 TXB T10 T15 T20 T25 T30 T40	0.500	2309165	1500 CT1-2163 TXB

Description		Code	No.
CT module empty	0.050	2324237	EI-1500 CT1-2163TXB L

## 1500 CT1-VDE 2170 PZ VDE SCREWDRIVER SET

in 1/3 CT tool module



Contents		Code	No.
⊖ VDE 2170 4 5,5 6,5 8	0.625	2309173	1500 CT1-VDE 2170 PZ
⊕ VDE 2160 PZ 1 2			

Description		Code	No.
CT module empty	0.050	2322552	EI-1500 CT1-VDE2170PZ L

## 1500 CT1-142 PLIERS SET

in 1/3 CT tool module



Contents		Code	No.
142 10 JC	1.220	2309025	1500 CT1-142
8250-180 JC 8132-160 JC 8316-160 JC			

Description		Code	No.
CT module empty	0.050	2322420	EI-1500 CT1-142 L

## 1500 CT1-VDE 142 VDE PLIERS SET

in 1/3 CT tool module



Contents		Code	No.
142 10 C	1.160	2309033	1500 CT1-VDE 142
VDE 8250-180 H VDE 8132-160 H VDE 8314-160 H			

Description		Code	No.
CT module empty	0.050	2322439	EI-1500 CT1-VDE142 L

## 1500 CT1-8000 CIRCLIP PLIERS

in 1/3 CT tool module



Contents		Code	No.
8000 A 1 8000 A 2 8000 A 21	1.010	2309181	1500 CT1-8000
8000 J 1 8000 J 2 8000 J 21			

Description		Code	No.
CT module empty	0.050	2322560	EI-1500 CT1-8000 L

## 1500 CT1-350 CHISEL SET

in 1/3 CT tool module

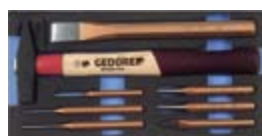

Contents		Code	No.
97-250 98-125 99 12-5	1.425	2309041	1500 CT1-350
100-12			
119-1,5 3 4			
600 H-300			

Description		Code	No.
CT module empty	0.050	2322447	EI-1500 CT1-350 L

## 1500 CT1-711 PRECISION MECHANICS

in 1/3 CT tool module



Contents		Code	No.
140	0.930	2309084	1500 CT1-711
4534-5			
708			
711 720 745			

Description		Code	No.
CT module empty	0.050	2322463	EI-1500 CT1-711 L





## CT MODULES 2005 CT FOR XL VOLUME DRAWERS

IN 3 SIZES:

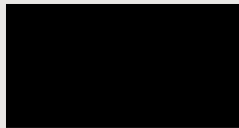

- > CT4 = 1/1 drawer 2005, workster (633 x 390 x 35 mm)
- > CT4 suitable for 2005, workster, 1504 XL, 2430

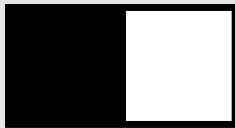

- > CT2 = 1/2 drawer 2005, workster (316.5 x 390 x 35 mm)
- > CT2 suitable for 1506 XL, 1504 and 2004

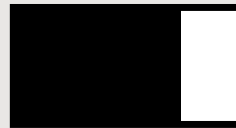

- > CT3 = 3/4 drawer 2005, workster (472.5 x 390 x 50 mm)
- > CT3 suitable for B 1500, 1502, 1505, 1504, 1504 XL, 1506, 2004, 2005, workster

## 2005 CT4-U-20 SOCKET SET 1/4"-3/8"-1/2"

in 4/4 CT tool module

> Dimensions: 633 x 390 x 35 mm



6.3  
1/4"  
10  
3/8"  
12.5  
1/2"

Contents		Code	No.
○ 20 5,5 6 7 8 9 10 11 12 13 14	3093 U-20	7.4	2016257
2093 U-20	3090 A-5 -10		2005 CT4-U-20
2093 U-3 T	3095		
2090-4 -6	⊗ D 19 10 11 12 13 14 15 16 17 18 19 21 22 23 24 27 30 32		
2095	1993 U-20		
⊗ D 30 8 9 10 11 12 13 14 15 16 17 18 19 21 22	1990-5 -10		
● IN 30 L 4 5 6 7 8 10	1930		
⊗ ITX 30 L T20 T25 T27 T30 T40 T45 T50	1995		
⊗ TX 30 E5 E6 E7 E8 E10 E11 E12 E14	1996		
⊕ IKS 30 1 2 3			
⊕ IKS 30 PZD 1 2 3			
⊖ IS 30 5,5 6,5 8 10 12			
52 53 56			

## 2005 CT2-D 19 SOCKET SET 1/2"

in 2/4 CT tool module

> Dimensions: 316.5 x 390 x 35 mm



12.5  
1/2"

Contents		Code	No.
⊗ D 19 10 11 12 13 14 15 16 17 18 19 20 21 22 23 24 25 26 27 28 29 30 32 34 36	4.4	2016494	2005 CT2-D 19
1990-5 -10			
1993 U-20			
1995			
1996			

## 2005 CT2-D 30 SOCKET SET 3/8"

in 2/4 CT tool module

> Dimensions:  
316.5 x 390 x 35 mm



10  
3/8"



Contents	kg	Code	No.
Ⓞ D 30 10 11 12 13 14 15 16 17 18 19 20 21 22 Ⓞ D 30 L 10 13 17 19 22 Ⓞ D 30 1/4 5/16 3/8 13/32 7/16 52 53 56 1/2 9/16 19/32 5/8 11/16 3/4 3090-3 -5 -10 13/16 25/32 7/8 15/16 1" 3093 U-20 3095 3096	3.4	2016486	2005 CT2-D 30

## 2005 CT2-D 20 SOCKET SET 1/4"

in 2/4 CT tool module

> Dimensions:  
316.5 x 390 x 35 mm



6.3  
1/4"  
6.3  
1/4"



Contents	kg	Code	No.
Ⓞ D 20 4 4,5 5 5,5 6 7 8 9 10 11 12 13 Ⓞ D 20 3/16 7/32 1/4 9/32 5/16 11/32 13/32 3/8 7/16 1/2 9/16" Ⓞ 20 L 4 4,5 5 5,5 6 7 8 9 10 11 12 13 2093 U-20 2093 U-3 T 2093 HR-94 2090-2 -4 -6 -12 2095 2097 2098 T 620 639 Ⓞ 680 4 6,5 Ⓞ 685 3 4 5 6 Ⓞ 685 X 5 6 8 Ⓞ 690 1 2 Ⓞ 690 PZD 1 2 3 Ⓞ 687 TX T8 T9 T10 T15 T20 T25 T27 T30 T40	1.6	2016478	2005 CT2-D 20

## 2005 CT3-32 SOCKET SET 3/4"

in 3/4 CT tool module

> Dimensions: 472.5 x 390 x 50 mm

**Suitable for:**

- > all drawers of models B 1500, 1502, 1505
- > only drawers with height 137 and 207 mm  
of models 1504, 1504 XL, 1506, 2004, 2005, workster



20  
3/4"



Contents	kg	Code	No.
Ⓞ 32 22 24 27 30 32 36 38 41 46 50 3290-8 -16 3293 U-2 3287	9.0	2752727	2005 CT3-32

## 2005 CT4-2-7 COMBINATION SPANNER SET

in 4/4 CT tool module

> Dimensions: 633 x 390 x 35 mm

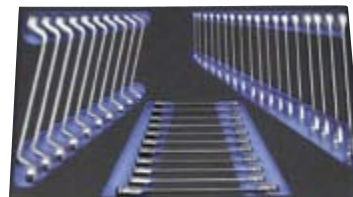

Schüsselknarre®  
R-Serie



Contents	kg	Code	No.
Ⓞ 2 6x7 8x9 10x11 12x13 14x15 16x17 18x19 20x22 21x23 24x27 Ⓞ 7 6 7 8 9 10 11 12 13 14 15 16 17 18 19 21 22 24 27 Ⓞ 7 R 10 11 12 13 14 15 16 17 18 19 22	5.8	2016265	2005 CT4-2-7

## 2005 CT4-7 XL COMBINATION SPANNER SET

in 4/4 CT tool module

> Dimensions: 633 x 390 x 35 mm

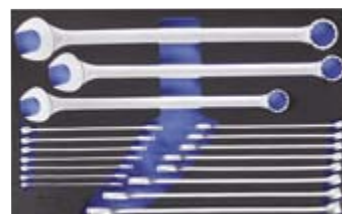

Contents	kg	Code	No.
Ⓞ 7 XL 10 11 12 13 14 15 16 17 18 19 21 22 24 27 30 32 36 41	8.2	2704226	2005 CT4-7 XL

## 2005 CT2-25PK DOUBLE ENDED SOCKET WRENCH SET

in 2/4 CT tool module

> Dimensions:  
316.5 x 390 x 35 mm

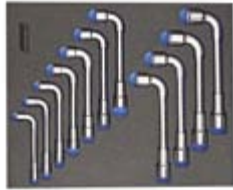

Contents	kg	Code	No.
○ 25 PK 8 10 11 12 13 14 15 16 17 18 19	2.548	2841851	2005 CT2-25PK

## 2005 CT2-2160 SCREWDRIVER SET

in 2/4 CT tool module

> Dimensions:  
316.5 x 390 x 35 mm



Contents	kg	Code	No.
⊕ 2160 PH 1 2 3	1.2	2016311	2005 CT2-2160
⊕ 2160 PZ 1 2 3			
⊖ 2150 3,5 5,5 8			
⊖ 2153 4			
⊕ 2161 PH 1			
⊕ 2161 PZ 1			
⊖ 173 4 8			
⊕ 174 1			

## 2005 CT4-8000 TOOL SET

in 4/4 CT tool module

> Dimensions:  
633 x 390 x 35 mm



Contents	kg	Code	No.
600 H-300 -500	4.0	2016303	2005 CT4-8000
248 ST-40			
142 10 JC			
8132-160 JC			
8316-160 JC			
8250-180 JC			
8000 A 1 A 2 A 21			
8000 J 1 J 2 J 21			

## E-2005 CT LENGTHWISE DIVIDER

without slots

> To fix the modules 2005 CT2

H	kg	Code	No.
40	0.248	2104601	E-2005 CT H-40

## 2005 CT2-119 TOOL SET

in 2/4 CT tool module

> Dimensions:  
316.5 x 390 x 35 mm



Contents	kg	Code	No.
95-200	2.4	2016338	2005 CT2-119
132-150			
99 12-3 12-5 12-6 12-8			
133-150 133 D-150			
100-12			
702 20 M			
119- 706 711 4612			
3 -4 -5 -6 -8 -84 -86 -175			

## 2005 CT4-2160-119 TOOL SET

in 4/4 CT tool module

> Dimensions:  
633 x 390 x 35 mm



Contents	kg	Code	No.
⊕ 2160 PH 1 2 3	3.6	2016435	2005 CT4-2160-119
⊕ 2160 PZ 1 2 3			
⊖ 2150 3,5 5,5 8			
⊖ 2153 4			
⊕ 2161 PH 1			
⊕ 2161 PZ 1			
⊖ 173 4 8			
⊕ 174 1			
95-200			
99 12-3 12-5 12-6 12-8			
100-12			
119-3 -4 -5 -6 -8 -84 -86 -175			
132-150 133-150 133 D-150			
702 20 M			
706 711 4612			

## 2005 CT2-TX 30 SOCKET SET 3/8"

in 2/4 CT tool module

> Dimensions:  
316.5 x 390 x 35 mm

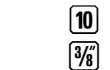
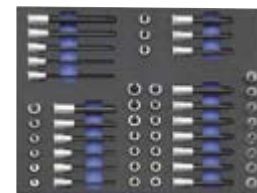

Contents	kg	Code	No.
● IN 30 4 5 6 7 8 10	3.0	2016508	2005 CT2-TX 30
● IN 30 L 4-95 5-95 6-95 7-95 8-95 10-95			
● IN 30 LK 4 5 6 8 10			
● ITX 30 T20 T25 T27 T30 T40 T45 T50			
● ITX 30 L T20 T25 T27 T30 T40 T45 T50			
● ITX 30 B T20 T25 T27 T30 T40 T45 T50			
● TX 30 E5 E6 E7 E8 E10 E11 E12 E14			
● INX 30 5 6 8			
● INX 30 L 6 8 10			

## 2005 CT2-D 19L SOCKET SET 1/2"

in 2/4 CT tool module

> Dimensions:  
316.5 x 390 x 35 mm



12.5  
1/2"

## 2005 CT2-INR SCREWDRIVER BIT SOCKET SET 1/2"

in 2/4 CT tool module

> Dimensions:  
316.5 x 390 x 35 mm

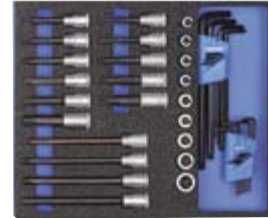

12.5  
1/2"

Contents	kg	Code	No.
<ul style="list-style-type: none"> <li>● D 19 L 10 12 13 14 15</li> <li>16 17 18 19 21 22 24</li> <li>27 30 32 34</li> <li>● IN 19 10 12 14 17 19</li> <li>● IN 19 L 12-140 14-140</li> <li>● IN 19 LK 10-140 12-140</li> <li>● INX 19 12 14</li> <li>● INX 19 L 12-100 14-100</li> <li>● ITX 19 T55 T60</li> <li>● ITX 19 L T55-100 T60-100</li> <li>● ITX 19 B T50 T55 T60</li> <li>● TX 19 E16 E18 E20 E24</li> </ul>	2.0	2016516	2005 CT2-D 19L

Contents	kg	Code	No.
<ul style="list-style-type: none"> <li>● ITX 19 B T20 T25 T27 T30 T40 T45 T50 T55 T60</li> <li>● INX 19 L 6-100 8-100 10-100 12-100 14-100</li> <li>● INR 19 L M5-100 M6-100 M6-188 M8-100 M8-188 M10-100 M10-188 M12-100 M12-188 M14-100</li> <li>● H 42 KEL-88 (2 2,5 3 4 5 6 8 10)</li> <li>● H 43 TX-09 (T7 T8 T9 T10 T15 T20 T25 T30 T40)</li> </ul>	3.6	2016281	2005 CT2-INR

## 2005 CT2-2142 TX SCREWDRIVER SET

in 2/4 CT tool module

> Dimensions:  
316.5 x 390 x 35 mm

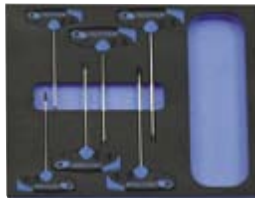

Contents	kg	Code	No.
<ul style="list-style-type: none"> <li>● 2142 TX T15 T20 T25 T27 T30 T40</li> </ul>	0.4	2016559	2005 CT2-2142 TX

## 2005 CT2-DT 2142 HEXAGON ALLEN KEY SET

in 2/4 CT tool module

> Dimensions:  
316.5 x 390 x 35 mm

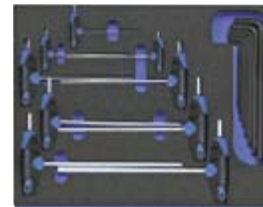

Contents	kg	Code	No.
<ul style="list-style-type: none"> <li>DT 2142 2 2,5 3 4 5 6 7 8 10</li> <li>H 42 KEL-88 (2 2,5 3 4 5 6 8 10)</li> </ul>	0.8	2016540	2005 CT2-DT 2142

## 2005 CT2-2143 KTX HEXAGON ALLEN KEY SET

in 2/4 CT tool module

> Dimensions:  
316.5 x 390 x 35 mm

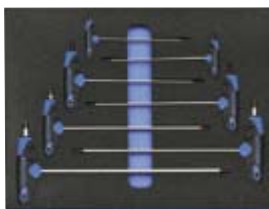

Contents	kg	Code	No.
<ul style="list-style-type: none"> <li>● DT 2143 KTX T10 T15 T20 T25 T27 T30 T40</li> </ul>	0.6	2016567	2005 CT2-2143 KTX

## 2005 CT2-2133 T NUT DRIVER SET

in 2/4 CT tool module

> Dimensions:  
316.5 x 390 x 35 mm

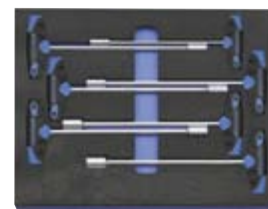

Contents	kg	Code	No.
<ul style="list-style-type: none"> <li>● 2133 T7 8 9 10 11 12 13</li> </ul>	1.2	2016532	2005 CT2-2133 T





# SPANNERS

RATCHET SPANNERS  
>123



COMBINATION SPANNERS  
>125



DOUBLE ENDED RING SPANNERS  
>129



OPEN ENDED SPANNERS  
>134



DEEP RING SPANNERS  
>141



SLOGGING SPANNERS  
>142



CROWFOOT SPANNERS  
>144



SWIVEL HEAD WRENCHES  
>145



SOCKET WRENCHES  
>146



MULTI FITTING KEYS  
>150



HOOK SPANNERS  
>150



ACCESSORIES  
>151



# SPANNERS OVERVIEW

## Durable and for high loadings

- › For heavy continuous use and safety in everyday work
- › High torque - GEDORE quality spanners do not fracture or splinter when overloaded, but deform under incorrect use, therefore posing a lower risk of injury to the user
- › Comfortable to hold due to ergonomic profiles without sharp edges
- › Secure grip even with oily hands
- › Non-glare look thanks to matt chrome-plating



## A well-functioning extended range

- › Extremely large selection in standardised and non-standardised, metric (mm), imperial (AF) and Whitworth (W) sizes
- › Top-grade industrial quality for the hardest of continuous use
- › Available individually or in practical sets or modules
- › Customised manufacturing, designs and types on request

## Everything safely under control

- › Use of the very best raw materials, state-of-the-art machinery and environmentally-friendly production processes
- › Tools without chrome VI have been a given thing for several years
- › Our tool experts guarantee precision-like processing and permanent development
- › Unique manufacturing processes and special tool treatment for optimum results
- › Stringent quality checks after each production step ensure a constantly high level
- › Professional service through to development of special customised tools



## Precision, correct measurements and perfect fit

- › The most important requirements a safe working environment
- › Complete transmission of available torque
- › Long life of nut and bolt
- › Profiles easy on the bolt heads (UD, jaw, hexagon)
- › Minimum production tolerances ensure that spanners fit perfectly on bolts

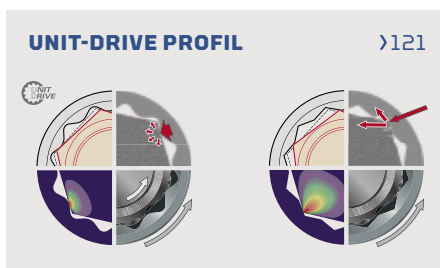













































# SPANNER MATRIX

## Why matt chrome-plated?

- > Non-glare look
- > Non-slip surface for a firm grip even when hands are dirty
- > Double protection against corrosion. A nickel layer is applied before chrome-plating. Nickel and chrome: these two layers combine to form optimum protection against corrosion.
- > Chrome chips are practically unheard of on matt chrome-plated tools
- > The matt chrome-plated GEDORE finish retains its elegant look for decades

## Type / Series Special

		 mm	 "AF	 Whitw.
<b>Combination spanner set</b>		<b>3 ▶ 80 mm</b>	<b>1/16" AF ▶ 2.7/16" AF</b>	<b>1/8 W ▶ 3/4 W</b>
<b>No. 1 B</b>	 matt chrome-plated	 5 - 80 mm	1/4" AF - 2.7/16" AF	1/8 W - 3/4 W
<b>No. 7</b>	 matt chrome-plated	 3 - 36 mm	3/16" AF - 1" AF	-
<b>No. 7 XL</b>	 matt chrome-plated	 7 - 46 mm	-	-
<b>No. 7 R</b>	  matt chrome-plated	 8 - 36 mm	-	-
<b>No. 7 UR</b>	  matt chrome-plated	 8 - 24 mm	-	-
<b>Open ended spanner</b>		<b>4 ▶ 135 mm</b>	<b>1/4" AF ▶ 1.1/2" AF</b>	
<b>No. 6</b>	matt chrome-plated	 4 x 4,5 - 55 x 60 mm	1/4 x 5/16" AF - 1.3/8" x 1.1/2" AF	-
<b>No. 8</b>	matt chrome-plated	 4 - 14 mm	-	-
<b>No. 60 CP</b>	 matt chrome-plated	 0 - 36 mm	-	-
<b>No. 60 P</b>	 matt chrome-plated	 0 - 36 mm	-	-
<b>No. 62 P</b>		 0 - 63 mm	-	-
<b>No. 60 S</b>	 matt chrome-plated	 0 - 36 mm	-	-
<b>No. 894</b>	manganese-phosphated	 6 - 135 mm	1/4" AF - 1.1/8" AF	-
<b>No. 895</b>	manganese-phosphated	 6 x 7 - 75 x 80 mm	-	-
<b>Ring spanner</b>		<b>5,5 ▶ 90 mm</b>	<b>1/4" AF ▶ 1" AF</b>	
<b>No. 2</b>	 matt chrome-plated	 5,5 x 7 - 55 x 60 mm	-	-
<b>No. 2 B</b>	 matt chrome-plated	 6 x 7 - 17 x 19 mm	-	-
<b>No. TX 4</b>	matt chrome-plated	 E6 x E8 - E20 x E24	-	-
<b>No. 4</b>	 matt chrome-plated	 6 x 7 - 46 x 50 mm	-	-
<b>No. 4 R</b>	  matt chrome-plated	 8 x 9 - 18 x 19 mm	1/4 x 5/16" AF - 1/2 x 9/16" AF	-
<b>No. 400</b>	matt chrome-plated	 8 x 10 - 46 x 50 mm	5/16 x 3/8" AF - 7/8 x 1" AF	-
<b>No. 304</b>	 matt chrome-plated offset	 11 x 13 - 19 x 22 mm	7/16 x 1/2" AF - 3/4 x 7/8" AF	-
<b>Slogging spanner</b>		<b>22 ▶ 135 mm</b>	<b>1" AF ▶ 3" AF</b>	
<b>No. 133</b>	shotblast finish	 27 - 130 mm	-	-
<b>No. 306</b>	shotblast finish	 22 - 135 mm	1" AF - 3" AF	-
<b>No. 306 G</b>	shotblast finish	 27 - 95 mm	-	-
<b>Deep ring spanner</b>		<b>24 ▶ 95 mm</b>		
<b>No. 308</b>	shotblast finish	 32 - 65 mm	-	-
<b>No. 2 A</b>	matt chrome-plated	 24 - 95 mm	-	-



# THE KEY TO SUCCESS

Hi-tech for the perfect size

Tolerances achieved by GEDORE



Tolerances permitted by DIN standards

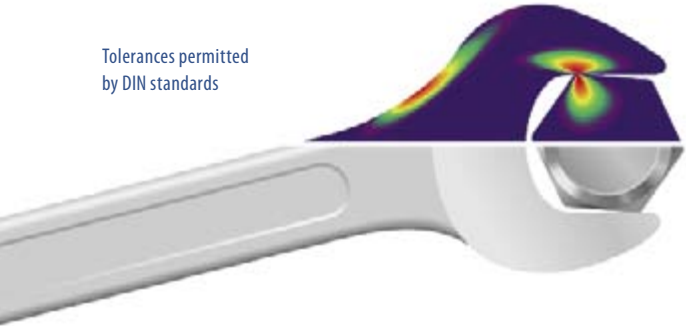

## Your Advantage - Your PLUS in safety

- > Precision dimensions ensure secure nut and bolt grip
- > Long life of nut and bolt
- > Complete transmission of available torque
- > Top quality for better safety

Open-ended spanners have been made since the dawn of technology. But the continued use of traditional tools does not mean that they are still manufactured by conventional production processes. Tried and tested production stages are subject to continuous development by our workforce. Where modern technology can improve the quality, it is used. GEDORE grinds the spanner jaws to the exact rated size, using a high-tech grinding machine. Perfect fit is the most important requirement for non-damaging and safe work.

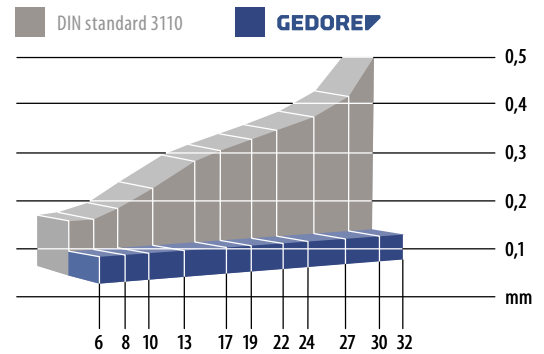

## THE PRODUCTION OF A SPANNER

From the tool blank to the final product. Quality comes with existence - Step by Step.



### 1. High-Quality Steel 31CrV3

Highly-efficient eccentric presses cut the blank for an open-ended spanner from high-quality flat steel.



### 2. Hot Forging Process

In the pusher furnace, the blank is heated to the exact pre-selected temperature and enters the forge while still red hot. The steel is given its form under the multiton blows of a drop hammer.



### 3. Thermally Hardened

Using a special thermal treatment, achieves maximum hardness - and a guarantee of long service life.



### 4. Precisely Ground

The jaws of the spanners are given their exact dimensions only after the hardening process. For this purpose, a high-tech grinding robot has been developed especially for this operation.



### 5. Carefully Smoothed

Any corners and edges still remaining are smoothed off by vibratory grinding, until the heads and shaft are absolutely free of burrs. The heads are additionally ground.



### 6. Extensively Treated

The extensive electroplating gives the spanners an effective surface protection and a perfect appearance. During this process, an efficient recycling plant ensures that the environment will not be affected.

# GEDORE UNIT DRIVE PROFILE

A perfect fit to protect the bolt



Traditional profile

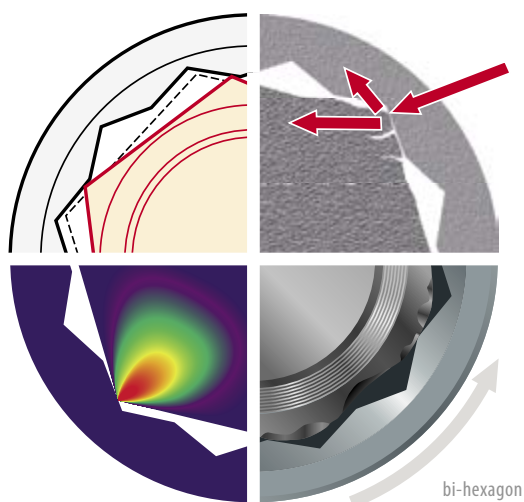

- 1** The reduced contact surface lessens the force closure. Certain torque transfer is no longer possible and can become a risk.
- 2** The influence exerted of the sharp edges raises the notching effect on the bolt. The profile is ruined.
- 3** Since there is no longer any torque transfer, the rounded bolt profiles cannot be unscrewed - the tool keeps on slipping.
- 4** Pronounced force on the tip of the bolt profile. Concentrated pressure deforms the bolt.



GEDORE UNIT DRIVE Profile

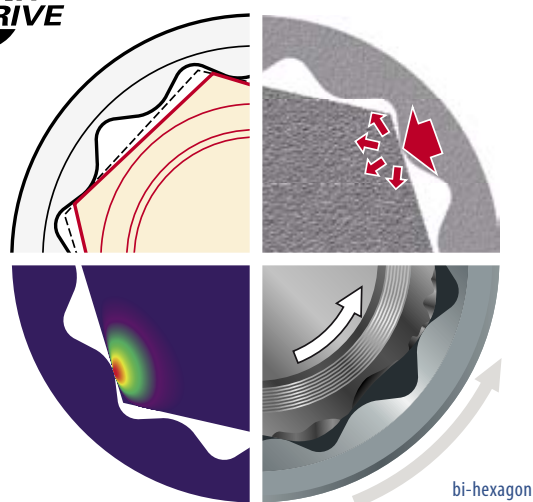

- 1** A large contact surface provides a secure force closure even for those bolts whose sizes lie outside of the tolerances.
- 2** Uniform distribution of the force on the bolt flanks. The resulting reduced notching effect stops the bolt from turning round and round.
- 3** Gentle torque transfer enables even worn bolts to be unscrewed with every certainty - no slipping of the tool at all.
- 4** Thanks to the optimally distributed force up to 20 % higher torques can be transferred.

The GEDORE UNIT DRIVE profile stops bolts from "turning round and round" by using of a wave form without any tipped or sharp edges. Enlarged, round contact surfaces of the GEDORE tools ensure that torque is reliably transferred - acting uniformly, as it does, on the bolt. The resulting minimised notching effect prevents any damage to the bolt profile. This represents added safety since - even with damaged bolts - there is no slipping or turning.





# THE REVOLUTION

## A PERFECT COLLECTION

All the benefits of the GEDORE U-20 technology, classic No. 6 and the slim, tried-and-tested No. 7 have been combined into these ratchet wrenches 7 R + 7 UR.

### + The non-glare look with grip (No. 6 + 7)

#### An extremely assured grip thanks to the surface profile - matt chrome-plated

The spanner surface is designed for both practical application and eye-appeal. The non-glare look comes from matt chrome-plating - the GEDORE surface profile is both kind-on-hands and very useful - a firm grip even with oily hands.

### + The ratchet (U-20)

#### Extra flat and sturdy - ideal for tough use and even at hard-to-reach areas

Extremely compact and highly efficient - for quick deployments and also under cramped conditions. The tried-and-tested U-20 ratchet technology incorporated in an extremely flat ring head ensures efficient ratcheting work - For both loosening and fast tightening. The sturdiness of the ratchet wrench is very much down to the number of teeth intentionally selected. The GEDORE pawl geometry optimises the actually large working angle occasioned by a small number of teeth.

### + The UD profile (No. 7)

#### Extremely easy on the bolt heads with the force ideally transferred

The wave form of the profile enlarges the spanner grip in every case - even with bolts whose dimensions are outside the tolerance range. Even distribution of pressure permits the maximum force to be applied.



### + The jaw (No. 6)

#### Highly dimensionally accurate / extremely precise - for non-damaging and safe working

The exact nominal dimension of the jaw and thus its fitting precision ensure a secure bolt fitting and long service life of both bolt and ratchet wrench - the most important requirement, in fact, for non-damaging and safe working.

### + The hollow shaft (No. 7)

#### Highly stable - ideal for transferring maximum forces

The kind-to-hands hollow profile makes for easy and tireless bolting. The GEDORE hollow profile has a geometry similar to that of a double T-girder. This makes it possible for substantial forces - particularly with large spanner sizes (34 and 36 mm) - to be transferred.

## Long life cycle

### ... precise and reliable, environment and maintenance-friendly

The fact that the ratchet spanner can be serviced underpins its sustainability. Even after any instance of incorrect use (e.g. given considerable soiling,

overstressing or moisture...) the ratchet wrench can be quickly made operable. Unscrew, slight re-greasing, screw down - and then continue to reliably undo the bolts.



## Combination Ratchet Spanners

### THE REVOLUTION

- > With same size each end
- > UD profile
- > High torque transfer
- > GEDORE vanadium steel 31CrV3
- > Non-glare look thanks to matt chrome-plating, locking insert and pawl manganese-phosphated
- > Hot forged
- > Jaw: ground precisely to exact nominal size for optimum contact areas
- > In combination with adaptor no. 7 RA or 7 RB (please order separately) the spanner no. 7 R and 7 UR can be used as a (bit) ratchet

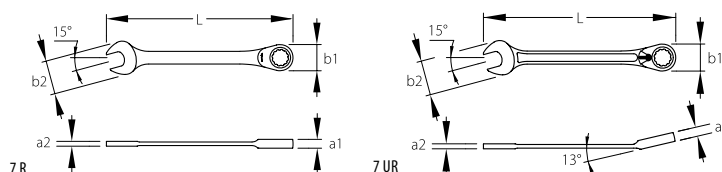
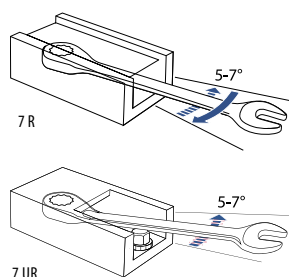
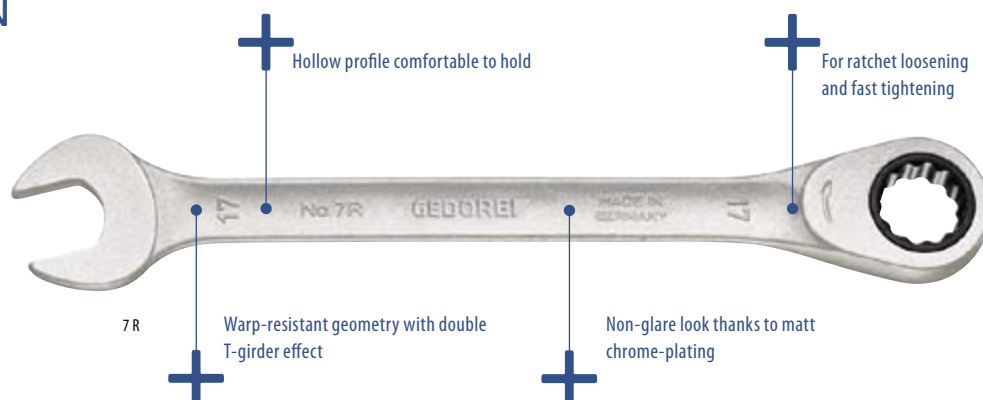

### 7 R COMBINATION RATCHET SPANNER

Flat pattern

Ø mm	∠°	L	a <sub>1</sub>	a <sub>2</sub>	b <sub>1</sub>	b <sub>2</sub>	⚖	Code	No.
8	7	140	7.0	3.8	17.5	19.8	0.032	2297051	7 R 8
9	7	150	7.3	3.9	19.3	21.5	0.042	2297078	7 R 9
10	7	160	7.7	4.1	21.0	23.0	0.054	2297086	7 R 10
11	7	164	8.1	4.3	22.5	26.0	0.063	2297094	7 R 11
12	7	170	8.6	4.6	23.6	27.5	0.069	2297108	7 R 12
13	7	180	9.0	4.7	25.7	30.0	0.088	2297116	7 R 13
14	7	190	9.4	4.9	28.2	31.8	0.101	2297124	7 R 14
15	7	200	9.8	5.2	29.5	34.0	0.125	2297132	7 R 15
16	6	212	10.2	5.7	31.7	35.0	0.137	2297140	7 R 16
17	6	225	10.6	5.9	33.6	38.0	0.160	2297159	7 R 17
18	6	237	11.0	6.1	34.6	40.0	0.197	2297167	7 R 18
19	6	250	11.7	6.4	36.3	42.0	0.202	2297175	7 R 19
21	6	274	12.5	6.9	40.0	45.5	0.262	2219433	7 R 21
22	6	292	13.3	7.1	42.5	48.0	0.319	2297191	7 R 22
24	6	325	14.8	7.9	48.0	52.5	0.520	2297205	7 R 24
27	6	359	16.0	8.3	53.5	59.5	0.590	2297213	7 R 27
30	5	399	17.4	8.8	59.0	63.0	0.780	2297221	7 R 30
32	5	424	17.9	9.3	63.0	67.5	0.920	2297248	7 R 32
34	5	449	18.4	9.7	65.5	72.0	1.010	2219549	7 R 34
36	5	480	18.9	10.2	70.0	75.0	1.208	2219557	7 R 36

### 7 UR COMBINATION RATCHET SPANNER

Ring 13° offset from shaft, reversible

Ø mm	∠°	L	a <sub>1</sub>	a <sub>2</sub>	b <sub>1</sub>	b <sub>2</sub>	⚖	Code	No.
8	7	140	7.0	3.8	17.5	19.8	0.037	2297256	7 UR 8
9	7	150	7.3	3.9	19.3	21.5	0.043	2297264	7 UR 9
10	7	160	7.7	4.1	21.0	23.0	0.053	2297272	7 UR 10
11	7	164	8.1	4.3	22.5	26.0	0.062	2297280	7 UR 11
12	7	170	8.6	4.6	23.6	27.5	0.069	2297299	7 UR 12
13	7	180	9.0	4.7	25.7	30.0	0.081	2297302	7 UR 13
14	7	190	9.4	4.9	28.2	31.8	0.098	2297310	7 UR 14
15	7	200	9.8	5.2	29.5	34.0	0.120	2297329	7 UR 15
16	6	212	10.2	5.7	31.7	35.0	0.153	2297337	7 UR 16
17	6	225	10.6	5.9	33.6	38.0	0.166	2297345	7 UR 17
18	6	237	11.0	6.1	34.6	40.0	0.178	2297353	7 UR 18
19	6	250	11.7	6.4	36.3	42.0	0.218	2297361	7 UR 19
21	6	274	12.5	6.9	40.0	45.5	0.264	2244500	7 UR 21
22	6	292	13.3	7.1	42.5	48.0	0.319	2297388	7 UR 22
24	6	325	14.8	7.9	48.0	52.5	0.449	2297396	7 UR 24

## 7 R-005 COMBINATION RATCHET SPANNER SET



5 pieces

- > Most used sizes combined in a set
- > Flat pattern
- > UD profile
- > High torque transfer
- > In plastic case
- > Dimensions: 275 x 150 x 42 mm



Contents		Code	No.
mm 7 R 8 10 13 17 19	0.932	2297434	7 R-005

## 7 R-012 COMBINATION RATCHET SPANNER SET



12 pieces

- > Most used sizes combined in a set
- > Flat pattern
- > UD profile
- > High torque transfer
- > In robust sheet-metal case
- > Dimensions: 320 x 210 x 55 mm



Contents		Code	No.
mm 7 R 8 9 10 11 12 13 14 15 16 17 18 19	2.840	2297442	7 R-012

## 7 UR-005 COMBINATION RATCHET SPANNER SET, REVERSIBLE



5 pieces

- > Most used sizes
- > Ring 13° offset from shaft, reversible
- > UD profile
- > High torque transfer
- > In plastic case
- > Dimensions: 275 x 150 x 42 mm



Contents		Code	No.
mm 7 UR 8 10 13 17 19	0.930	2327651	7 UR-005

## 7 UR-012 COMBINATION RATCHET SPANNER SET, REVERSIBLE



12 pieces

- > Most used sizes
- > Ring 13° offset from shaft, reversible
- > UD profile
- > High torque transfer
- > In robust sheet-metal case
- > Dimensions: 320 x 210 x 55 mm



Contents		Code	No.
mm 7 UR 8 9 10 11 12 13 14 15 16 17 18 19	2.840	2297418	7 UR-012

## 7 RA ADAPTOR

for 7 R/7 UR

- > The adapter transforms the ring ratchet spanner into a ratchctet
- > Wear-resistant and manganese phosphated push-button
- > Fast-turning ring for swift release or tightening
- > Secure adaptor fit in the ring ratchet thanks to circlip
- > Chrome-plated



mm	"		H		Code	No.
10	1/4	6.3	18.0	0.011	2320495	7 RA-6,3
13	3/8	10.0	24.0	0.030	2320487	7 RA-10
19	1/2	12.5	32.0	0.070	2320479	7 RA-12,5

## 7 RB BIT ADAPTOR

for 7 R/7 UR

- > The adaptor transforms the ring ratchet spanner into a bit ratchet
- > Secure adaptor fit in the ring ratchet thanks retaining ball
- > With magnetic screw retainer
- > Manganese-phosphated body



"		mm	H		Code	No.
1/4	6.3	10	20.5	0.011	2329239	7 RB-6,3
5/16	8.0	10	23.0	0.015	2327643	7 RB-8

## Combination Spanners

### NO. 1 B - "THE STRONG ALL-ROUNDER"

- > Acc. to DIN 3113 Form B, ISO 3318, ISO 7738
- > Sizes 5 and 5.5 mm with hexagon ring, up from size 6 mm with UD profile
- > GEDORE vanadium steel 31CrV3, chrome-plated
- > Carefully forged and professionally machined
- > Overloading indicated by deformation
- > The offset ring ensures a better grip on deep-seated or inset nuts or bolts
- > Top-grade industrial quality for the hardest of continuous use

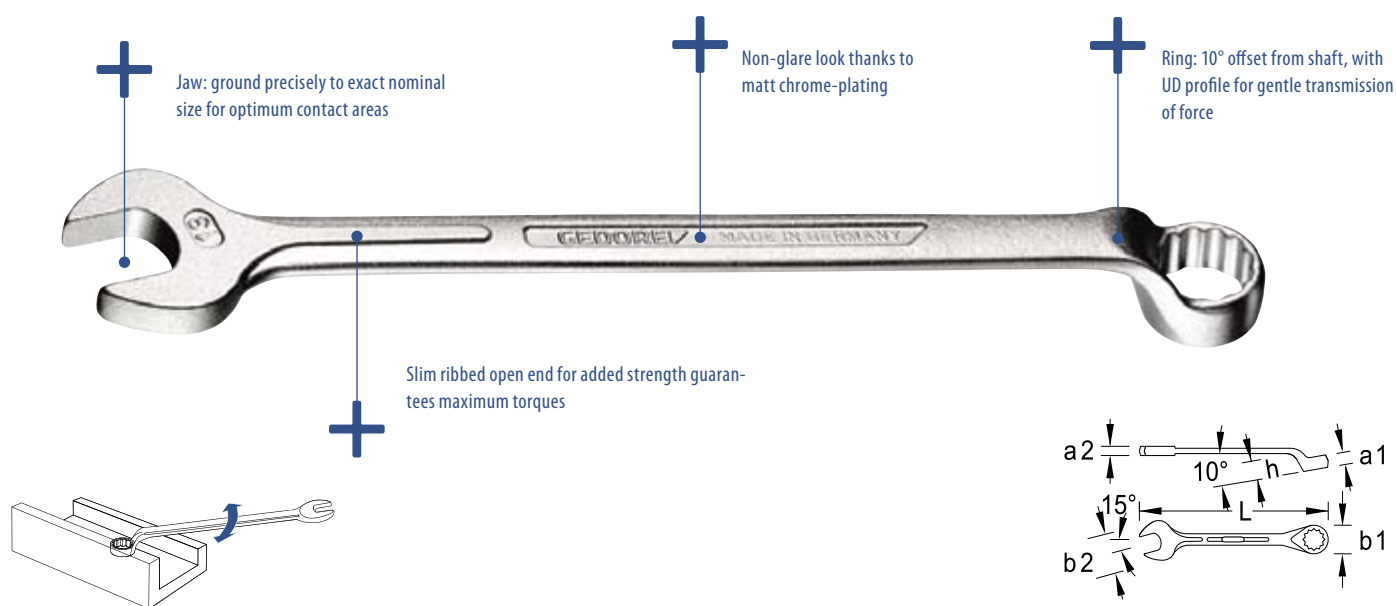

## 1 B (MM) COMBINATION SPANNERS



\* not standardised

Ø mm	L	a <sub>1</sub>	a <sub>2</sub>	b <sub>1</sub>	b <sub>2</sub>	h		Code	No.
5.0	100	5.0	3.4	8.5	14.5	9.5	0.015	6000240	1 B 5
5.5	100	5.0	3.4	9.2	14.5	9.5	0.015	6000320	1 B 5,5
6.0	100	5.0	3.4	9.8	15.5	9.5	0.016	6000400	1 B 6
7.0	112	6.0	3.7	11.2	17.2	10.5	0.028	6000590	1 B 7
8.0	125	6.5	4.0	12.5	19.2	11.5	0.026	6000670	1 B 8
9.0	138	7.5	4.3	14.0	21.2	12.5	0.035	6000750	1 B 9
10.0	148	8.2	4.7	15.5	23.5	14.0	0.042	6000830	1 B 10
11.0	158	9.0	5.0	16.8	25.5	15.0	0.050	6000910	1 B 11
12.0	168	9.5	5.3	18.2	27.2	16.0	0.064	6001050	1 B 12
13.0	185	10.2	6.0	19.5	30.0	16.5	0.080	6001130	1 B 13
14.0	198	11.0	6.3	21.0	32.0	17.5	0.091	6001210	1 B 14
15.0	210	11.5	6.7	22.2	34.0	19.0	0.139	6001480	1 B 15
16.0	220	12.0	7.0	23.5	36.0	20.0	0.128	6001560	1 B 16
17.0	232	12.5	7.5	25.0	38.0	21.0	0.153	6001640	1 B 17
18.0	245	13.2	7.7	26.5	40.0	22.5	0.183	6001720	1 B 18
19.0	258	13.5	8.0	27.8	42.0	23.5	0.210	6001800	1 B 19
20.0	270	14.5	8.5	29.2	44.0	24.5	0.245	6001990	1 B 20
21.0	280	14.5	8.7	30.5	45.8	26.0	0.281	6002020	1 B 21
22.0	292	14.5	9.0	32.0	48.2	27.0	0.294	6002100	1 B 22
23.0	305	15.5	9.3	33.5	49.8	28.0	0.350	6002290	1 B 23
24.0	318	15.5	9.5	35.0	52.0	29.5	0.372	6002370	1 B 24
25.0	*	328	17.5	10.0	36.2	54.2	0.431	6002450	1 B 25
26.0	*	340	17.5	10.3	37.5	56.0	0.481	6002530	1 B 26
27.0	*	352	17.5	10.5	39.0	58.0	0.514	6002610	1 B 27
28.0	*	370	19.5	11.0	40.2	60.0	0.578	6002880	1 B 28
29.0	*	370	19.5	11.0	41.8	61.8	0.546	6002960	1 B 29
30.0	*	390	19.5	11.2	43.2	63.5	0.672	6003180	1 B 30
32.0	*	412	20.5	11.8	46.0	68.0	0.684	6003260	1 B 32
33.0	*	412	20.5	11.8	47.5	70.5	0.827	6003340	1 B 33
34.0	*	412	20.5	11.8	49.0	70.5	0.784	6004150	1 B 34
36.0	*	460	23.5	12.8	52.2	76.2	1.147	6003420	1 B 36
38.0	*	460	24.2	13.2	56.0	79.2	1.081	6003500	1 B 38
41.0	*	520	25.5	14.0	60.2	85.0	1.452	6003690	1 B 41
46.0	*	550	27.5	15.0	68.0	95.5	1.893	6003770	1 B 46
50.0	*	580	29.5	16.0	74.0	103.0	2.268	6003850	1 B 50
55.0	*	620	30.5	17.0	82.0	112.5	2.900	6003930	1 B 55
60.0	*	660	32.0	18.0	90.0	121.0	3.600	6004070	1 B 60
65.0	*	710	33.0	22.0	98.0	133.0	4.415	6004660	1 B 65
70.0	*	760	35.0	24.0	105.0	143.0	5.625	6004740	1 B 70
75.0	*	810	38.0	26.0	110.0	153.0	6.545	6004820	1 B 75
80.0	*	860	41.0	28.0	119.0	163.0	8.790	6004900	1 B 80

# 1 B (AF) COMBINATION SPANNERS

INCH



○"AF	L	a <sub>1</sub>	a <sub>2</sub>	b <sub>1</sub>	b <sub>2</sub>	h	⚖️	Code	No.
1/4	100	5.0	3.4	10.2	16.2	9.5	0.016	6005120	1 B 1/4AF
5/16	125	6.5	4.0	12.5	19.2	11.5	0.027	6005200	1 B 5/16AF
3/8	148	8.2	4.7	14.8	22.2	14.0	0.045	6005390	1 B 3/8AF
7/16	158	9.0	5.0	17.0	25.8	15.0	0.053	6005470	1 B 7/16AF
1/2	185	10.2	6.0	19.2	29.2	16.5	0.085	6005550	1 B 1/2AF
9/16	198	11.0	6.3	21.5	32.0	17.5	0.099	6005630	1 B 9/16AF
5/8	220	12.0	7.0	23.5	36.0	20.0	0.136	6005710	1 B 5/8AF
11/16	245	13.2	7.7	25.8	40.0	22.5	0.192	6005980	1 B 11/16AF
3/4	258	13.5	8.0	27.8	42.0	23.5	0.209	6006010	1 B 3/4AF
13/16	280	14.5	8.7	30.2	45.8	26.0	0.269	6006280	1 B 13/16AF
7/8	292	14.5	9.0	32.5	48.2	27.0	0.308	6006360	1 B 7/8AF
15/16	318	15.5	9.5	34.8	52.0	29.5	0.403	6006440	1 B 15/16AF
1	340	17.5	10.3	36.8	55.2	32.0	0.473	6006520	1 B 1AF
1.1/16	352	17.5	10.5	39.0	58.0	33.0	0.559	6006600	1 B 1.1/16AF
1.1/8	370	19.5	11.0	41.0	61.8	34.5	0.587	6006790	1 B 1.1/8AF

○"AF	L	a <sub>1</sub>	a <sub>2</sub>	b <sub>1</sub>	b <sub>2</sub>	h	⚖️	Code	No.
1.1/4	412	20.5	11.8	45.8	70.5	39.0	0.861	6006870	1 B 1.1/4AF
1.5/16	412	20.5	11.8	48.5	70.5	39.0	0.789	6006950	1 B 1.5/16AF
1.3/8	460	23.5	12.8	51.5	75.2	43.0	1.099	6007090	1 B 1.3/8AF
1.7/16	460	23.5	12.8	53.0	75.2	43.0	1.085	6007170	1 B 1.7/16AF
1.1/2	460	24.2	13.2	56.0	79.2	43.0	1.113	6007250	1 B 1.1/2AF
1.5/8	520	25.5	14.0	60.5	85.0	49.0	1.457	6007330	1 B 1.5/8AF
1.3/4	550	27.5	15.0	66.0	95.5	53.0	1.896	6007410	1 B 1.3/4AF
1.13/16	550	27.5	15.0	68.0	95.5	53.0	1.870	6007680	1 B 1.13/16AF
1.7/8	550	27.5	15.0	69.0	95.5	53.0	1.821	6007760	1 B 1.7/8AF
2	580	29.5	16.0	74.5	103.0	57.0	2.280	6007840	1 B 2AF
2.1/16	580	29.5	16.0	75.0	103.0	57.0	2.250	6007920	1 B 2.1/16AF
2.3/16	620	30.5	17.0	82.0	112.5	62.0	2.855	6008060	1 B 2.3/16AF
2.1/4	620	30.5	17.0	83.0	112.5	62.0	2.820	6008140	1 B 2.1/4AF
2.3/8	660	32.0	18.0	90.0	121.0	67.0	3.510	6008220	1 B 2.3/8AF
2.7/16	660	32.0	18.0	91.0	121.0	67.0	3.630	6008300	1 B 2.7/16AF

# 1 B (WW) COMBINATION SPANNERS

Whitworth



⊙Whitw.	L	a <sub>1</sub>	a <sub>2</sub>	b <sub>1</sub>	b <sub>2</sub>	h	⚖️	Code	No.
1/8	138	7.5	4.3	13.5	21.2	12.5	0.035	6009540	1 B 1/8W
3/16	158	9.0	5.0	17.5	26.0	15.0	0.053	6009620	1 B 3/16W
1/4	185	10.2	6.0	20.0	30.0	16.5	0.082	6009700	1 B 1/4W
5/16	210	11.5	6.7	22.5	34.0	19.0	0.115	6009890	1 B 5/16W
3/8	245	13.2	7.7	26.5	40.0	22.5	0.190	6009970	1 B 3/8W

⊙Whitw.	L	a <sub>1</sub>	a <sub>2</sub>	b <sub>1</sub>	b <sub>2</sub>	h	⚖️	Code	No.
7/16	280	14.5	8.7	30.2	45.8	26.0	0.274	6010040	1 B 7/16W
1/2	305	15.5	9.3	34.0	50.5	28.0	0.343	6010120	1 B 1/2W
9/16	340	17.5	10.3	37.0	56.0	32.0	0.477	6010200	1 B 9/16W
5/8	370	19.5	11.0	40.2	61.8	34.5	0.573	6010390	1 B 5/8W
11/16	390	19.5	11.2	43.8	65.2	36.0	0.713	6010470	1 B 11/16W
3/4	412	20.5	11.8	48.0	70.5	39.0	0.803	6010550	1 B 3/4W

# 1 B (MM) / 1 B (AF) COMBINATION SPANNER SETS



1B-080

pieces	Contents	⚖️	No.	Code
8	10 12 13 14 17 19 22 24	2.600	1B-08	6011870
8	8 9 10 11 13 14 17 19	1.000	1B-080	6011950
11	8 9 10 11 12 13 14 15 17 19 22	1.190	1B-011	6012250
11	7 8 10 11 12 13 14 16 17 18 19	1.050	1B-110	6013140
12	10 11 12 13 14 17 19 22 24 27 30 32	3.390	1B-012	6012170
12	6 7 8 9 10 11 12 13 14 15 17 19	0.925	1B-0112	6012840
15	6 7 8 9 10 11 12 13 17 19 22 24 27 30 32	3.385	1B-0115	6000160
17	6 7 8 9 10 11 12 13 14 15 16 17 18 19 20 21 22	2.300	1B-017	6012680
20	8 9 10 11 12 13 14 15 16 17 18 19 21 22 23 24 26 27 30 32	5.500	1B-020	6013060
26	6 7 8 9 10 11 12 13 14 15 16 17 18 19 20 21 22 23 24 25 26 27 28 29 30 32	7.500	1B-026	6012920

INCH

pieces	Contents	⚖️	No.	Code
8	3/8 7/16 1/2 9/16 5/8 3/4 7/8 1"	1.410	1B-08 A	6013300
14	5/16 3/8 7/16 1/2 9/16 5/8 11/16 3/4 13/16 7/8 1 1.1/16 1.1/8 1.1/4"	3.488	1B-014 A	6013650



## NO. 7 - "SLIM LINE"

- > Acc. to DIN 3113 Form A, ISO 3318, ISO 7738
- > GEDORE vanadium steel 31CrV3, chrome-plated
- > **Carefully forged and professionally machined**
- > Slim jaw and jaw walls make this spanner lighter overall
- > Overloading indicated by deformation
- > Secure grip thanks to hollow shaft - very ergonomic and handy
- > Non-glare look thanks to matt chrome-plating
- > Designed for universal use
- > Top-grade industrial quality for the hardest of continuous use

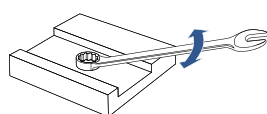
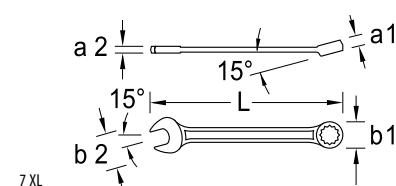

## 7 (MM) COMBINATION SPANNERS

with same size each end

- > Sizes 3 to 5.5 with hexagon ring, up from size 6 with UD profile
- \* not standardised

Ø mm		L	a <sub>1</sub>	a <sub>2</sub>	b <sub>1</sub>	b <sub>2</sub>	⚖	Code	No.
3.0	*	78	2.8	2.8	6.5	9.2	0.006	6080680	7 3
3.2	*	78	2.8	2.8	6.5	9.2	0.006	6080760	7 3,2
3.5	*	78	2.8	2.8	6.5	9.2	0.006	6080840	7 3,5
4.0	*	85	3.2	3.2	7.7	11.8	0.010	6080920	7 4
4.5	*	85	3.2	3.2	7.7	11.8	0.009	6081060	7 4,5
5.0	*	92	3.6	3.6	9.7	13.2	0.011	6081140	7 5
5.5	*	92	3.6	3.6	9.7	13.2	0.011	6081220	7 5,5
6.0		100	5.0	3.4	10.0	16.2	0.014	6089550	7 6
7.0		110	5.5	3.6	11.5	17.5	0.017	6089630	7 7
8.0		120	6.0	3.8	12.7	19.8	0.024	6089710	7 8
9.0		130	6.5	4.0	14.0	21.5	0.028	6089980	7 9
10.0		140	7.0	4.2	15.5	23.0	0.033	6090050	7 10
11.0		150	7.5	4.5	17.0	26.0	0.042	6090130	7 11
12.0		160	8.0	4.8	18.5	27.5	0.050	6090210	7 12
13.0		170	8.5	5.0	19.5	30.0	0.058	6090480	7 13
14.0		180	9.0	5.2	21.0	31.8	0.069	6090560	7 14
15.0		190	9.5	5.5	22.5	34.0	0.080	6090640	7 15
16.0		200	10.0	5.8	23.0	35.0	0.092	6091610	7 16

Ø mm		L	a <sub>1</sub>	a <sub>2</sub>	b <sub>1</sub>	b <sub>2</sub>	⚖	Code	No.
17.0		210	10.5	6.0	25.0	38.0	0.111	6090720	7 17
18.0		220	11.0	6.2	26.0	40.0	0.121	6091880	7 18
19.0		230	11.5	6.5	28.0	42.0	0.140	6090800	7 19
20.0	*	240	12.0	6.8	29.0	44.2	0.170	6091960	7 20
21.0		252	12.5	7.0	30.0	45.5	0.182	6092180	7 21
22.0		262	13.0	7.2	32.0	48.0	0.200	6090990	7 22
23.0	*	270	13.5	7.6	33.0	49.5	0.223	6092260	7 23
24.0		282	14.0	8.0	35.0	52.5	0.264	6091020	7 24
25.0	*	290	14.5	8.2	36.0	54.5	0.295	6092340	7 25
26.0	*	302	15.0	8.2	37.0	56.5	0.309	6092420	7 26
27.0		310	15.5	8.5	39.0	59.5	0.344	6091100	7 27
28.0	*	320	16.0	8.8	40.0	60.0	0.375	6092500	7 28
29.0	*	330	16.5	8.8	41.5	61.5	0.394	6092690	7 29
30.0		340	17.0	9.0	43.0	63.0	0.428	6091290	7 30
32.0		370	18.0	9.5	46.0	67.5	0.535	6091370	7 32
34.0		420	19.0	10.0	49.0	72.0	0.624	1827987	7 34
36.0		460	20.0	10.5	52.0	75.0	0.726	6089470	7 36

## 7 (AF) COMBINATION SPANNERS

with same size each end, INCH

Ø"AF	L	a <sub>1</sub>	a <sub>2</sub>	b <sub>1</sub>	b <sub>2</sub>	⚖	Code	No.
3/16	85	3.2	3.2	7.7	11.8	0.010	1436767	7 3/16AF
7/32	92	3.6	3.6	9.7	13.2	0.011	1436775	7 7/32AF
1/4	100	5.0	3.4	10.0	16.2	0.013	6098700	7 1/4AF
5/16	120	6.0	3.8	12.7	19.8	0.024	6098890	7 5/16AF
11/32	130	6.5	4.0	14.0	21.5	0.026	6098970	7 11/32AF
3/8	140	7.0	4.2	15.5	23.0	0.038	6099190	7 3/8AF
7/16	150	7.5	4.5	17.0	26.0	0.041	6099270	7 7/16AF
1/2	170	8.5	5.0	19.5	30.0	0.056	6099430	7 1/2AF

Ø"AF	L	a <sub>1</sub>	a <sub>2</sub>	b <sub>1</sub>	b <sub>2</sub>	⚖	Code	No.
9/16	180	9.0	5.2	21.0	31.8	0.063	6099510	7 9/16AF
5/8	200	10.0	5.8	23.0	35.0	0.104	6099780	7 5/8AF
11/16	220	11.0	6.2	26.0	40.0	0.122	6099860	7 11/16AF
3/4	230	11.5	6.5	28.0	42.0	0.148	6099940	7 3/4AF
13/16	252	12.5	7.0	30.0	45.5	0.187	6100030	7 13/16AF
7/8	262	13.0	7.2	32.0	48.0	0.192	6100110	7 7/8AF
15/16	282	14.0	8.0	34.0	52.5	0.296	6100380	7 15/16AF
1	302	15.0	8.2	36.0	56.5	0.287	6100460	7 1AF

# 7 XL COMBINATION SPANNERS

with same size each end, extra long

> Extra-long shaft for deep applications and high-torque

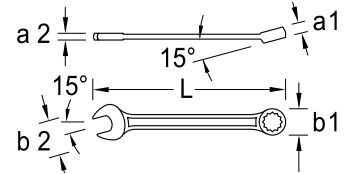

Ø mm	L	a <sub>1</sub>	a <sub>2</sub>	b <sub>1</sub>	b <sub>2</sub>		Code	No.
7	160	6.5	4.0	12.5	18.5	0.031	1394916	7 XL 7
8	170	7.0	4.5	13.5	20.8	0.042	6080090	7 XL 8
9	180	7.5	4.5	14.5	22.5	0.054	6080170	7 XL 9
10	190	8.5	5.0	16.0	24.0	0.011	6097300	7 XL 10
11	200	9.0	5.5	17.5	27.0	0.076	6097490	7 XL 11
12	210	10.0	5.5	19.0	28.5	0.086	6100540	7 XL 12
13	225	10.5	6.0	20.0	31.0	0.102	6100620	7 XL 13
14	235	10.8	6.5	22.0	32.8	0.120	6100700	7 XL 14
15	250	11.2	7.0	23.0	35.0	0.147	6100890	7 XL 15
16	265	11.8	7.5	24.8	36.0	0.171	6080250	7 XL 16
17	280	12.2	8.5	26.0	39.0	0.196	6100970	7 XL 17
18	295	13.2	8.5	27.8	41.0	0.233	6080330	7 XL 18

Ø mm	L	a <sub>1</sub>	a <sub>2</sub>	b <sub>1</sub>	b <sub>2</sub>		Code	No.
19	310	14.2	9.5	29.0	43.0	0.276	6101000	7 XL 19
21	340	14.2	9.5	32.5	46.5	0.352	6080410	7 XL 21
22	350	16.2	11.0	33.5	49.0	0.392	6101190	7 XL 22
24	400	18.2	12.0	36.5	53.5	0.521	6101270	7 XL 24
27	450	20.2	13.0	40.5	60.5	0.711	6101350	7 XL 27
30	480	21.2	14.0	44.5	63.0	0.839	6101780	7 XL 30
32	500	22.2	14.0	47.5	69.0	0.956	6101430	7 XL 32
34	520	23.2	15.0	49.5	70.5	1.088	6101940	7 XL 34
36	550	24.2	15.0	53.0	76.0	1.248	6101510	7 XL 36
41	600	26.0	16.0	62.0	84.5	2.000	6102080	7 XL 41
46	640	28.0	17.0	70.0	96.0	2.278	6102160	7 XL 46

# 7 (MM) / 7 (AF) COMBINATION SPANNER SET



# 7 XL COMBINATION SPANNER SET



extra long

> Extra-long shaft for deep applications and high-torque



7-08



7 XL-080

pieces	No.	Contents		Code
8	7-08	10 12 13 14 17 19 22 24	0.973	6092770
8	7-080	8 9 10 11 13 14 17 19	0.536	6092850
11	7-011	8 9 10 11 12 13 14 15 17 19 22	0.868	6093070
11	7-0110	7 8 10 11 12 13 14 16 17 18 19	0.782	6096090
12	7-0112	6 7 8 9 10 11 12 13 14 15 17 19	0.686	6091530
12	7-012	10 11 12 13 14 17 19 22 24 27 30 32	2.700	6093150
17	7-017	6 7 8 9 10 11 12 13 14 15 16 17 18 19 20 21 22	1.465	6093580
20	7-020	8 9 10 11 12 13 14 15 16 17 18 19 21 22 23 24 26 27 30 32	3.360	6093660
26	7-026	6 7 8 9 10 11 12 13 14 15 16 17 18 19 20 21 22 23 24 25 26 27 28 29 30 32	4.665	6093740

## INCH

pieces	No.	Contents		Code
8	7-08 A	3/8 7/16 1/2 9/16 5/8 3/4 7/8 1"	1.047	6091450

pieces	No.	Contents		Code
8	7 XL-080	8 9 10 11 13 14 17 19	0.962	6104880
11	7 XL-0111	8 10 11 12 13 14 16 17 18 19 22	1.794	6104960
12	7 XL-012	10 11 12 13 14 17 19 22 24 27 30 32	4.410	6095950

1500 ES / 1500 CT

>98 / 105



## Double Ended Ring Spanners

### NO. 4 R - THE "DOUBLE WITH RATCHET"

- > Flat pattern
- > Thin walled rings
- > UD profile
- > Working angle: 7° up to 14x15 mm, 6° from 16x17 mm to 18x19 mm
- > For ratchet loosening and fast tightening
- > GEDORE vanadium steel 31CrV3
- > Non-glare look thanks to matt chrome-plating, locking insert and pawl manganese-phosphated
- > Hot forged
- > Tried-and-tested GEDORE technology combined anew: stable hollow shaft of no. 7 and refined mechanism of the U-20 ratchets
- > In combination with adaptor no. 7 RA or 7 RB (please order separately) the spanner no. 4 R can be used as a (bit) ratchet

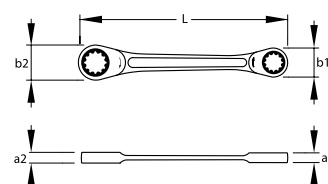

## 4 R (MM) / 4 R (AF) DOUBLE RING RATCHET SPANNER



Ø mm	∠°	L	a <sub>1</sub>	a <sub>2</sub>	b <sub>1</sub>	b <sub>2</sub>		Code	No.
8 x 9	7	134.0	7.0	7.3	17.5	19.3	0.040	2306719	4 R 8x9
8 x 10	7	144.0	7.0	7.7	17.5	21.0	0.060	2306727	4 R 8x10
10 x 11	7	153.5	7.7	8.1	21.0	22.5	0.070	2306743	4 R 10x11
10 x 13	7	165.5	7.7	9.0	21.0	25.7	0.080	2306751	4 R 10x13
12 x 13	7	174.5	8.6	9.0	23.6	25.7	0.090	2306786	4 R 12x13

Ø mm	∠°	L	a <sub>1</sub>	a <sub>2</sub>	b <sub>1</sub>	b <sub>2</sub>		Code	No.
14 x 15	7	197.0	9.4	9.8	28.2	29.5	0.140	2306794	4 R 14x15
16 x 17	6	222.0	10.2	10.6	31.7	33.6	0.200	2306808	4 R 16x17
17 x 19	6	235.0	10.6	11.7	33.6	36.3	0.220	2306816	4 R 17x19
18 x 19	6	248.0	11.0	11.7	34.6	36.3	0.230	2306832	4 R 18x19

### INCH

Ø AF	∠°	L	a <sub>1</sub>	a <sub>2</sub>	b <sub>1</sub>	b <sub>2</sub>		Code	No.
1/4 x 5/16	7	134.0	7.0	7.3	17.5	19.3	0.035	2825015	4 R 1/4x5/16AF
5/16 x 11/32	7	134.0	7.0	7.3	17.5	19.3	0.040	2825031	4 R 5/16x11/32AF

Ø AF	∠°	L	a <sub>1</sub>	a <sub>2</sub>	b <sub>1</sub>	b <sub>2</sub>		Code	No.
3/8 x 7/16	7	153.5	7.7	8.1	21.0	22.5	0.070	2825023	4 R 3/8x7/16AF
1/2 x 9/16	7	197.0	9.4	9.8	28.2	29.5	0.100	2825007	4 R 1/2x9/16AF

1500 CT 1 - 7R

&gt;106



1500 CT 1 - 7UR

&gt;106

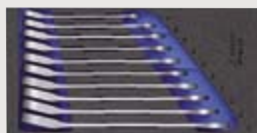

1500 CT 2 - 7

&gt;106



## NO. 2 - "OFFSET"

- > Rings deep offset, strong but thin walls
- > Acc. to DIN 838, ISO 3318, ISO 1085, ISO 10104
- > GEDORE vanadium steel 31CrV3, chrome-plated
- \* not standardised
- > Carefully forged and professionally machined:
- > Ring: thin-walled, 5° deep offset from shaft, with UD profile for gentle transmission of force

- > High bending strength - does not fracture or splinter when overloaded, thus minimising the risk of injury
- > Overloading indicated by deformation
- > Non-glare look thanks to matt chrome-plating
- > Specialist for extremely deep or inset bolts
- > Top-grade industrial quality for the hardest of continuous use

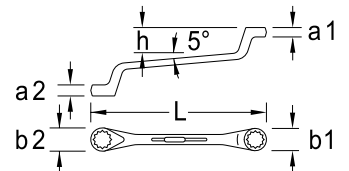
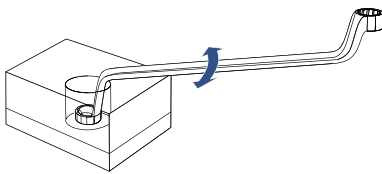

## 2 DOUBLE ENDED RING SPANNERS



> \* not standardised

Ø mm	L	a <sub>1</sub>	a <sub>2</sub>	b <sub>1</sub>	b <sub>2</sub>	h		Code	No.
5,5 x 7	170	5.6	6.6	10.0	12.0	20.7	0.062	6010630	2.5,5x7
6 x 7	170	5.6	6.6	10.5	12.0	20.7	0.045	6015350	2.6x7
7 x 8	180	5.6	6.6	12.0	13.3	21.7	0.068	6015430	2.7x8
8 x 9	182	6.6	7.6	13.3	14.4	21.7	0.065	6015510	2.8x9
8 x 10	182	6.6	8.5	13.3	15.9	21.7	0.072	6015780	2.8x10
9 x 11	195	7.6	9.5	14.4	17.5	23.6	0.086	6015860	2.9x11
10 x 11	195	8.5	9.5	15.9	17.5	23.6	0.089	6015940	2.10x11
10 x 12	195	8.5	9.6	15.9	19.0	23.6	0.089	6016080	2.10x12
10 x 13	212	8.5	10.3	15.9	20.1	25.1	0.122	6016160	2.10x13
11 x 13	212	9.5	10.3	17.5	20.1	25.1	0.129	6016320	2.11x13
12 x 13	212	9.6	10.3	19.0	20.1	25.1	0.125	6016590	2.12x13
12 x 14	212	9.6	10.6	19.0	21.6	25.1	0.134	6016670	2.12x14
13 x 14	225	10.3	10.6	20.1	21.6	26.1	0.156	6016750	2.13x14
13 x 15	225	10.3	11.3	20.1	23.1	26.1	0.160	6016830	2.13x15
13 x 17	245	10.3	12.3	20.1	25.8	27.1	0.212	6017050	2.13x17
14 x 15	225	10.6	11.3	21.6	23.1	26.1	0.154	6016910	2.14x15
14 x 17	245	10.6	12.3	21.6	25.8	27.1	0.227	6017130	2.14x17
16 x 17	245	11.6	12.3	24.2	25.8	27.1	0.205	6017210	2.16x17
16 x 18	265	11.6	12.6	24.2	27.0	28.6	0.250	6025660	2.16x18
17 x 19	265	12.3	13.0	25.8	28.8	28.6	0.250	6017480	2.17x19
18 x 19	265	12.6	13.0	27.0	28.8	28.6	0.258	6017560	2.18x19
18 x 21	285	12.6	13.4	27.0	31.1	31.0	0.327	6025740	2.18x21
19 x 22	287	13.0	14.3	28.8	33.0	31.0	0.352	6017720	2.19x22
19 x 24	305	13.0	14.4	28.8	35.7	33.0	0.419	6017990	2.19x24
20 x 22	287	13.3	14.3	30.1	33.0	31.0	0.345	6017800	2.20x22
21 x 23	305	13.4	14.3	30.9	34.0	33.0	0.411	6018020	2.21x23
21 x 24	307	13.4	14.4	30.9	35.7	33.0	0.386	6025820	2.21x24

Ø mm	L	a <sub>1</sub>	a <sub>2</sub>	b <sub>1</sub>	b <sub>2</sub>	h		Code	No.
22 x 24	307	14.3	14.4	32.8	35.7	33.0	0.412	6018100	2.22x24
24 x 26	325	14.4	15.3	35.7	38.0	34.5	0.503	6018370	2.24x26
24 x 27	325	14.4	15.4	35.7	40.1	34.5	0.506	6018450	2.24x27
24 x 30	345	14.4	16.4	35.7	44.1	35.5	0.579	6018530	2.24x30
25 x 28	345	14.4	15.4	37.0	41.1	35.5	0.565	6018610	2.25x28
27 x 29	345	14.8	16.4	40.1	42.5	35.5	0.678	6018880	2.27x29
27 x 30	345	15.4	16.4	40.1	44.1	35.5	0.628	6018960	2.27x30
27 x 32	370	15.4	17.4	40.1	47.1	37.4	0.701	6019180	2.27x32
30 x 32	370	16.4	17.4	44.1	47.1	37.4	0.731	6019260	2.30x32
30 x 34	375	16.4	18.7	44.1	50.0	37.4	0.763	6025900	2.30x34
30 x 36	400	16.4	19.4	43.2	52.6	38.4	0.872	6019340	2.30x36
32 x 36	400	17.4	19.4	47.1	53.0	38.4	0.878	6019420	2.32x36
34 x 36	420	18.7	19.4	50.0	53.0	38.4	0.929	6026040	2.34x36
36 x 41	440	19.4	20.4	53.0	60.5	40.4	1.166	6019500	2.36x41
38 x 42	440	19.7	20.4	56.4	62.5	40.4	1.207	6019690	2.38x42
41 x 46	485	20.4	22.2	62.0	68.9	42.8	1.535	6019770	2.41x46
46 x 50	535	22.2	23.6	68.9	75.5	47.8	2.035	6019850	2.46x50
55 x 60	610	24.6	25.6	84.9	91.8	54.2	3.125	6019930	2.55x60

## 2

## DOUBLE ENDED RING SPANNER SET



- > Sets of the most used sizes
- > Rings deep offset, strong but thin walls, UD profile
- > Acc. to DIN 838, ISO 3318, ISO 1085, ISO 10104
- > GEDORE vanadium steel 31CrV3, chrome-plated



pieces	Contents		Code	No.
8	6x7 8x9 10x11 12x13 14x15 16x17 18x19 20x22	1.297	6030580	2-8
10	6x7 8x9 10x11 12x13 14x15 16x17 18x19 20x22 21x23 24x27	2.225	6030740	2-10
10	6x7 8x9 10x11 12x13 14x15 16x17 18x19 20x22 24x27 30x32	2.555	6031120	2-100
12	6x7 8x9 10x11 12x13 14x15 16x17 18x19 20x22 21x23 24x26 25x28 27x32	4.060	6030900	2-12
12	6x7 8x9 10x11 12x13 14x15 16x17 18x19 20x22 21x23 24x27 25x28 30x32	4.000	6031040	2-120
12	6x7 8x9 10x11 12x13 14x15 16x18 17x19 20x22 21x23 24x26 27x32 30x34	3.730	6031390	2-122 ISO

## 2 B

## DOUBLE ENDED RING SPANNER

short pattern

- > Shallow offset
- > Thin walled rings
- > GEDORE vanadium steel 31CrV3, chrome-plated

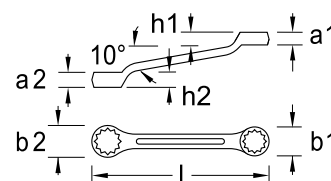

mm	L	a <sub>1</sub>	a <sub>2</sub>	b <sub>1</sub>	b <sub>2</sub>	h <sub>1</sub>	h <sub>2</sub>		Code	No.
6 x 7	115	5.5	6.5	10.5	12.0	6	7	0.023	6051150	2 B 6x7
8 x 9	120	6.5	7.5	12.5	13.5	8	9	0.029	6051230	2 B 8x9
10 x 11	125	6.5	7.5	15.0	17.0	8	9	0.037	6051310	2 B 10x11
12 x 13	135	8.5	9.5	18.5	20.0	10	11	0.056	6051580	2 B 12x13
14 x 15	145	9.5	10.5	21.0	22.0	11	12	0.075	6051660	2 B 14x15
17 x 19	155	10.5	11.5	25.0	28.0	15	17	0.105	6051740	2 B 17x19



# 4 FLAT RING SPANNER

straight pattern

- > Acc. to DIN 837 Form B, ISO 3318, ISO 1085
- > Flat pattern
- > Thin walled rings

- > UD-profile
- > GEDORE vanadium steel 31CrV3, chrome-plated
- \* not standardised

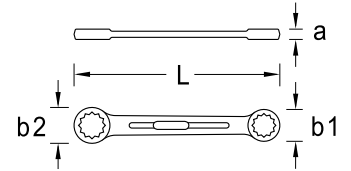

Ø mm	L	a	b <sub>1</sub>	b <sub>2</sub>	$\frac{kg}{mm^3}$	Code	No.
6 x 7	99	4.5	10.0	11.5	0.014	6052710	4 6x7
8 x 9	114	5.2	13.0	14.5	0.024	6053010	4 8x9
8 x 10	115	5.2	13.0	16.0	0.022	6053280	4 8x10
10 x 11	131	5.8	16.0	17.0	0.034	6053440	4 10x11
10 x 13	149	6.4	16.0	20.5	0.045	6053520	4 10x13
12 x 13	149	6.4	19.0	20.5	0.049	6053870	4 12x13
13 x 15	161	7.2	20.5	23.0	0.064	6054170	4 13x15
14 x 15	161	7.2	21.5	23.0	0.064	6054250	4 14x15
13 x 17	167	7.8	20.5	25.5	0.074	6054330	4 13x17
14 x 17	169	7.8	21.5	25.5	0.077	6054410	4 14x17
16 x 17	169	7.8	24.5	25.5	0.084	6054680	4 16x17
17 x 19	186	8.5	25.5	28.0	0.098	6054760	4 17x19
18 x 19	186	8.5	27.0	28.0	0.106	6054840	4 18x19
19 x 22	209	9.4	28.0	32.5	0.136	6054920	4 19x22
20 x 22	*	209	9.4	29.5	0.134	6055060	4 20x22

Ø mm	L	a	b <sub>1</sub>	b <sub>2</sub>	$\frac{kg}{mm^3}$	Code	No.
19 x 24	*	233	10.0	28.0	0.176	6055140	4 19x24
21 x 23	*	233	10.0	30.5	0.171	6055220	4 21x23
22 x 24		233	10.0	32.5	0.184	6055300	4 22x24
24 x 26	*	261	10.8	35.5	0.230	6055490	4 24x26
24 x 27		260	10.8	35.5	0.249	6055570	4 24x27
25 x 28	*	289	11.6	36.5	0.273	6055730	4 25x28
24 x 30		290	11.6	35.5	0.303	6055650	4 24x30
27 x 32		320	12.6	39.0	0.373	6055810	4 27x32
30 x 32		320	12.6	43.5	0.399	6056030	4 30x32
30 x 36		357	13.8	43.5	0.469	6056110	4 30x36
32 x 36		357	13.8	46.0	0.492	6056380	4 32x36
36 x 41		391	15.0	51.5	0.616	6056460	4 36x41
41 x 46		431	16.2	59.0	0.789	6056540	4 41x46
46 x 50		473	16.5	66.0	1.035	6056620	4 46x50

# 4 FLAT RING SPANNER SET

- > Made up of sizes most in use
- > Flat pattern
- > Thin walled rings
- > UD-profile
- > Acc. to DIN 837 Form B, ISO 3318, ISO 1085
- > GEDORE vanadium steel 31CrV3, chrome-plated



pieces	Contents	$\frac{kg}{mm^3}$	Code	No.
8	6x7 8x9 10x11 12x13 14x15 16x17 18x19 20x22	0.521	6061700	4-8
12	6x7 8x9 10x11 12x13 14x15 16x17 18x19 20x22 21x23 24x26 25x28 27x32	1.549	6062000	4-12
12	6x7 8x9 10x11 12x13 14x15 16x17 18x19 20x22 21x23 24x27 25x28 30x32	2.000	6062190	4-120

# TX 4 FLAT RING SPANNER

straight pattern, for protruding TORX® head screws

- > GEDORE vanadium steel 31CrV3, chrome-plated
- > TORX® = reg. trademark of Acument Intellectual Properties, LLC. USA

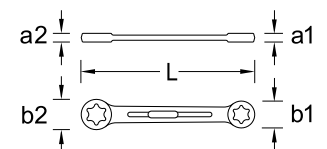

Ø	□ mm	★ mm	L	a <sub>1</sub>	a <sub>2</sub>	b <sub>1</sub>	b <sub>2</sub>	$\frac{kg}{mm^3}$	Code	No.
E6xE8	M5 - M7	5,74 x 7,52	110	5.0	6.0	9.0	11.0	0.014	6059800	TX 4 E6xE8
E10xE12	M8 - M10	9,42 x 11,17	140	7.0	8.0	13.0	15.0	0.039	6059990	TX 4 E10xE12
E14xE18	M12 - M14	12,9 x 16,7	180	8.5	9.5	17.0	21.0	0.074	6060140	TX 4 E14xE18
E20xE24	M16 - M20	18,45 x 22,16	226	11.5	13.5	24.5	28.5	0.163	6060220	TX 4 E20xE24

## SPECIAL

- > Thin walled rings
- > GEDORE vanadium steel 31CrV3, chrome-plated
- > Specialists in tight spaces

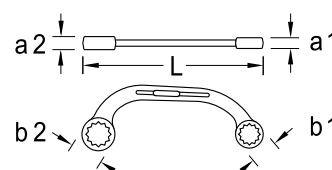
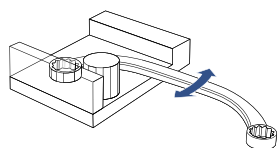
304 / 304 (AF)  
HALF-MOON RING SPANNER

Ø mm	L	a <sub>1</sub>	a <sub>2</sub>	b <sub>1</sub>	b <sub>2</sub>	⚖	Code	No.
11 x 13	150	7.0	7.5	17.0	20.5	0.077	6470040	304 11x13
13 x 15	185	8.5	8.5	20.5	23.0	0.129	6470630	304 13x15
13 x 17	185	8.5	8.5	20.5	25.5	0.140	6470120	304 13x17
14 x 16	185	8.5	8.5	21.5	24.5	0.137	6470200	304 14x16

Ø mm	L	a <sub>1</sub>	a <sub>2</sub>	b <sub>1</sub>	b <sub>2</sub>	⚖	Code	No.
14 x 17	185	8.5	8.5	21.5	25.5	0.144	6470390	304 14x17
15 x 17	185	8.5	8.5	23.0	25.5	0.150	6470470	304 15x17
16 x 18	185	8.5	8.5	24.5	27.0	0.163	6567550	304 16x18
19 x 22	230	10.0	10.5	28.0	32.5	0.261	6470550	304 19x22

## INCH

Ø" AF	L	a <sub>1</sub>	a <sub>2</sub>	b <sub>1</sub>	b <sub>2</sub>	⚖	Code	No.
7/16 x 1/2	150	7.0	7.5	17.0	20.5	0.079	6471010	304 7/16x1/2AF
9/16 x 5/8	185	8.5	8.5	21.5	24.5	0.139	6471280	304 9/16x5/8AF

Ø" AF	L	a <sub>1</sub>	a <sub>2</sub>	b <sub>1</sub>	b <sub>2</sub>	⚖	Code	No.
5/8 x 3/4	230	10.0	10.5	24.5	28.0	0.219	6471360	304 5/8x3/4AF
3/4 x 7/8	230	10.0	10.5	28.0	32.5	0.247	6471440	304 3/4x7/8AF

## NO. 400

- > Acc. to DIN 3118
- > Sizes 8x10 to 12x14 mm with hexagon

- > GEDORE vanadium steel 31CrV3, chrome-plated
- > For applications involving hydraulic/brake lines

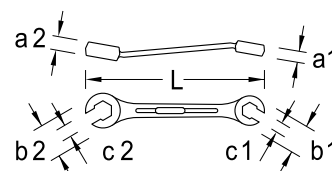
400 (MM) / 400 (AF)  
FLARE NUT SPANNER, OPEN

\* not standardised

Ø mm	L	a <sub>1</sub>	a <sub>2</sub>	b <sub>1</sub>	b <sub>2</sub>	c <sub>1</sub>	c <sub>2</sub>	⚖	Code	No.
8 x 10	140	6.5	8.0	18	20	6.0	7.0	0.045	6057190	400 8x10
9 x 11	145	7.5	8.5	19	22	6.5	8.5	0.059	6056970	400 9x11
10 x 11	150	8.0	9.5	20	22	7.0	8.5	0.064	6057270	400 10x11
10 x 12	150	8.0	9.5	20	24	7.0	9.0	0.073	6051070	400 10x12
11 x 13	160	8.5	10.5	22	26	8.5	10.0	0.077	6057350	400 11x13
12 x 14	170	9.5	11.2	24	28	9.0	11.0	0.106	6057430	400 12x14
13 x 15	180	10.5	11.8	26	29	10.0	12.0	0.116	6057000	400 13x15
14 x 17	195	11.5	12.2	28	32	11.0	14.0	0.136	6057510	400 14x17

Ø mm	L	a <sub>1</sub>	a <sub>2</sub>	b <sub>1</sub>	b <sub>2</sub>	c <sub>1</sub>	c <sub>2</sub>	⚖	Code	No.
17 x 19	210	12.2	13.2	32	35	14.0	15.0	0.179	6057780	400 17x19
19 x 22	230	13.2	15.2	35	41	15.0	17.0	0.246	6058670	400 19x22
22 x 24	250	15.2	16.2	41	45	17.0	18.0	0.335	6057860	400 22x24
24 x 27	270	16.2	17.2	45	48	18.0	20.0	0.408	6058750	400 24x27
30 x 32	300	20.2	22.2	50	52	22.0	24.0	0.575	6058830	400 30x32
36 x 41	351	25.2	28.2	58	66	25.0	32.0	0.980	1933175	400 36x41
46 x 50	396	31.5	33.5	74	79	35.0	39.0	0.800	2297183	400 46x50

## INCH

Ø" AF	L	a <sub>1</sub>	a <sub>2</sub>	b <sub>1</sub>	b <sub>2</sub>	c <sub>1</sub>	c <sub>2</sub>	⚖	Code	No.
5/16 x 3/8	140	6.5	8.0	18	20	6.0	7.0	0.043	6057940	400 5/16x3/8AF
3/8 x 7/16	150	8.0	8.5	20	22	7.0	8.5	0.057	6058080	400 3/8x7/16AF
7/16 x 1/2	160	8.5	10.5	22	26	8.5	10.0	0.076	6058160	400 7/16x1/2AF
1/2 x 9/16	170	9.5	11.2	24	28	10.0	11.0	0.092	6058240	400 1/2x9/16AF

Ø" AF	L	a <sub>1</sub>	a <sub>2</sub>	b <sub>1</sub>	b <sub>2</sub>	c <sub>1</sub>	c <sub>2</sub>	⚖	Code	No.
9/16 x 5/8	195	11.2	12.2	28	32	11.0	13.0	0.129	6058320	400 9/16x5/8AF
5/8 x 3/4	210	12.2	13.2	32	35	13.0	15.0	0.178	6058400	400 5/8x3/4AF
3/4 x 7/8	230	13.2	15.2	35	41	15.0	17.0	0.235	6056700	400 3/4x7/8AF
7/8 x 1	250	15.2	16.2	41	45	17.0	19.0	0.304	6058590	400 7/8x1AF

## Open Ended Spanners

### NO. 6 - "STRONG AND ACCURATE"

- > Acc. to DIN 3110, ISO 3318, ISO 1085, ISO 10102
- > Top-grade industrial quality for the hardest of continuous use
- > Overloading indicated by deformation
- > GEDORE vanadium steel 31CrV3, heads finely polished, chrome-plated

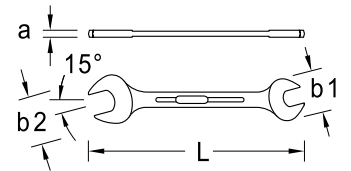
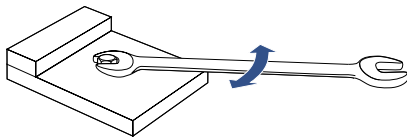
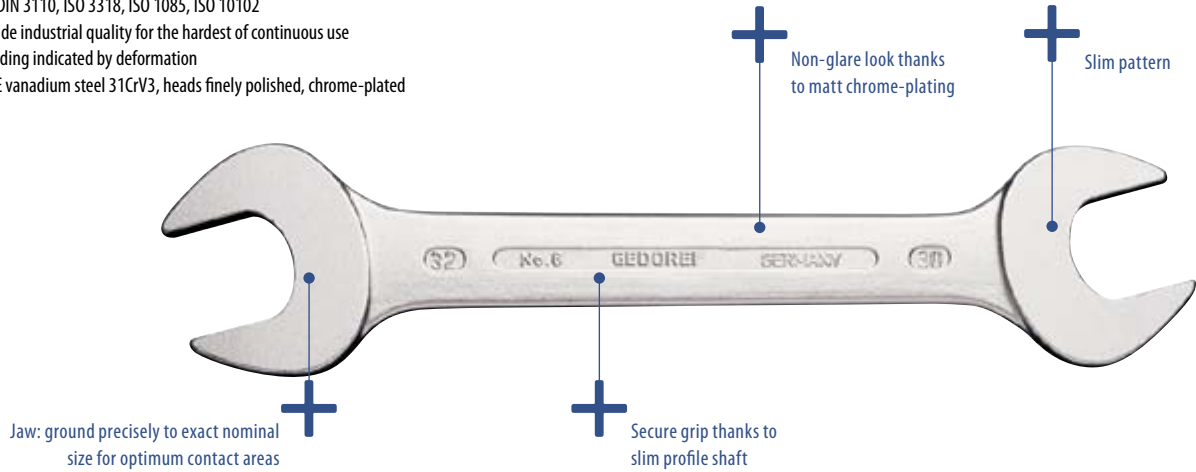

## 6 (MM) DOUBLE OPEN ENDED SPANNER

\* not standardised

Ø mm	L	a	b <sub>1</sub>	b <sub>2</sub>	⚖	Code	No.	
4 x 4,5	*	100	3.4	13.0	14.0	0.014	6063400	6 4x4,5
4 x 5	*	100	3.4	13.0	14.0	0.013	6063590	6 4x5
5 x 5,5	*	100	3.4	14.5	16.0	0.016	6063670	6 5x5,5
5,5 x 7	*	122	3.5	16.0	17.5	0.023	6063750	6 5,5x7
6 x 7		122	3.5	16.5	17.5	0.022	6063830	6 6x7
6 x 8	*	122	3.5	16.5	20.0	0.025	6063910	6 6x8
7 x 8		140	3.8	17.5	20.0	0.034	6064050	6 7x8
7 x 9	*	140	3.8	17.5	22.0	0.035	6064130	6 7x9
8 x 9		140	3.8	20.0	22.0	0.035	6064210	6 8x9
8 x 10		140	4.0	20.0	23.5	0.036	6064480	6 8x10
9 x 10	*	157	4.5	22.0	23.5	0.046	6064560	6 9x10
9 x 11	*	157	4.5	22.0	26.5	0.050	6064640	6 9x11
10 x 11		157	4.5	23.5	26.5	0.050	6064720	6 10x11
10 x 12	*	157	4.5	23.5	28.0	0.051	6064800	6 10x12
10 x 13		172	5.0	23.5	30.5	0.065	6064990	6 10x13
11 x 13		172	5.0	26.5	30.5	0.068	6065100	6 11x13
11 x 14	*	172	5.0	26.5	32.0	0.072	6065290	6 11x14
12 x 13		172	5.0	28.0	30.5	0.069	6065370	6 12x13
12 x 14		172	5.0	28.0	32.0	0.076	6065450	6 12x14
13 x 14		178	5.0	30.5	32.0	0.081	6065530	6 13x14
13 x 15		188	5.5	30.5	34.5	0.098	6065610	6 13x15
13 x 16		190	5.5	30.5	35.5	0.098	6068980	6 13x16
14 x 15		188	5.5	32.0	34.5	0.095	6065880	6 14x15
13 x 17		205	6.0	30.5	38.5	0.122	6065960	6 13x17
14 x 17		205	6.0	32.0	38.5	0.119	6066180	6 14x17
16 x 17		205	6.0	35.5	38.5	0.128	6066260	6 16x17
16 x 18		205	6.0	35.5	40.5	0.129	6066340	6 16x18
17 x 19		222	6.5	38.5	43.0	0.168	6066420	6 17x19

Ø mm	L	a	b <sub>1</sub>	b <sub>2</sub>	⚖	Code	No.	
18 x 19		222	6.5	40.5	43.0	0.174	6066500	6 18x19
18 x 21		236	7.0	40.5	46.0	0.196	6069360	6 18x21
17 x 22	*	236	7.0	38.5	48.5	0.205	6066690	6 17x22
19 x 22		236	7.0	43.0	48.5	0.219	6066770	6 19x22
20 x 22	*	236	7.0	44.5	48.5	0.213	6066850	6 20x22
19 x 24		250	7.5	43.0	53.5	0.256	6066930	6 19x24
21 x 23	*	247	7.5	46.0	50.0	0.245	6067070	6 21x23
21 x 24		250	7.5	46.0	53.5	0.268	6069440	6 21x24
22 x 24		250	7.5	48.5	53.5	0.260	6067150	6 22x24
22 x 27	*	266	8.0	48.5	60.0	0.336	6067230	6 22x27
24 x 26	*	266	8.0	53.5	56.5	0.321	6067310	6 24x26
24 x 27		266	8.0	53.5	60.0	0.337	6067580	6 24x27
24 x 30		280	8.5	53.5	63.5	0.390	6067660	6 24x30
25 x 28	*	280	8.5	55.0	60.0	0.378	6067740	6 25x28
27 x 29	*	302	9.0	60.0	63.5	0.456	6067820	6 27x29
27 x 30		302	9.0	60.0	63.5	0.466	6067900	6 27x30
27 x 32		302	9.0	60.0	68.0	0.487	6068040	6 27x32
30 x 32		302	9.0	63.5	68.0	0.504	6068120	6 30x32
30 x 34		302	9.0	63.5	72.0	0.503	6069520	6 30x34
30 x 36		328	9.4	63.5	76.0	0.677	6068200	6 30x36
32 x 36		328	9.4	68.0	76.0	0.594	6068390	6 32x36
34 x 36		328	9.4	71.0	75.0	0.624	6069600	6 34x36
36 x 41		360	10.0	76.0	84.5	0.770	6068470	6 36x41
38 x 42	*	360	10.0	77.0	86.0	0.784	6068550	6 38x42
41 x 46		400	10.7	86.5	95.5	1.104	6068630	6 41x46
46 x 50		450	11.6	95.5	102.0	1.445	6068710	6 46x50
55 x 60	*	560	18.0	113.0	123.0	3.160	2312107	6 55x60

## 6 (AF) DOUBLE OPEN ENDED SPANNER

INCH

6 (AF)	L	a	b <sub>1</sub>	b <sub>2</sub>	⚖️	Code	No.	6 (AF)	L	a	b <sub>1</sub>	b <sub>2</sub>	⚖️	Code	No.
1/4 x 5/16	122	3.7	17.5	20.0	0.024	6070020	6 1/4x5/16AF	13/16 x 7/8	236	7.0	46.0	48.5	0.232	6071500	6 13/16x7/8AF
5/16 x 3/8	140	4.0	20.0	23.5	0.035	6070100	6 5/16x3/8AF	7/8 x 15/16	250	7.5	48.5	52.0	0.268	6071690	6 7/8x15/16AF
3/8 x 7/16	157	4.5	23.5	26.5	0.047	6070290	6 3/8x7/16AF	7/8 x 1.1/16	266	8.0	48.5	60.0	0.323	6073550	6 7/8x1.1/16AF
7/16 x 1/2	172	5.0	26.5	30.0	0.065	6070370	6 7/16x1/2AF	15/16 x 1	266	8.0	52.0	55.0	0.317	6071770	6 15/16x1AF
1/2 x 9/16	190	5.5	30.0	33.0	0.091	6070450	6 1/2x9/16AF	1 x 1.1/8	280	8.5	55.0	61.0	0.395	6071930	6 1x1.1/8AF
9/16 x 5/8	190	5.5	33.0	36.0	0.092	6070530	6 9/16x5/8AF	1.1/16 x 1.1/8	302	9.0	60.0	63.5	0.453	6072070	6 1.1/16x1.1/8AF
19/32 x 11/16	205	6.0	34.5	39.5	0.130	6070610	6 19/32x11/16AF	1.1/16 x 1.1/4	302	9.0	60.0	68.0	0.520	6072150	6 1.1/16x1.1/4AF
5/8 x 11/16	205	6.0	36.0	39.5	0.124	6070880	6 5/8x11/16AF	1.1/8 x 1.5/16	302	9.0	65.5	70.5	0.537	6072230	6 1.1/8x1.5/16AF
5/8 x 3/4	222	6.5	36.0	42.5	0.152	6070960	6 5/8x3/4AF	1.3/16 x 1.5/16	302	9.0	65.5	70.5	0.521	6072310	6 1.3/16x1.5/16AF
3/4 x 25/32	222	6.5	42.5	43.5	0.189	6071260	6 3/4x25/32AF	1.1/4 x 1.3/8	328	9.4	69.5	75.5	0.604	6072580	6 1.1/4x1.3/8AF
3/4 x 7/8	236	7.0	42.5	48.5	0.216	6071340	6 3/4x7/8AF	1.5/16 x 1.1/2	328	9.4	74.0	79.0	0.656	6072740	6 1.5/16x1.1/2AF
25/32 x 13/16	236	7.0	44.5	46.0	0.206	6071420	6 25/32x13/16AF	1.3/8 x 1.1/2	328	9.4	74.0	79.0	0.655	6072820	6 1.3/8x1.1/2AF

## 6 (MM) / 6 (AF) DOUBLE OPEN ENDED SPANNER SET



6-12

pieces	No.	Contents	⚖️	Code
6	6-6	6x7 8x9 10x11 12x13 14x15 16x17	0.415	6076810
8	6-8	6x7 8x9 10x11 12x13 14x15 16x17 18x19 20x22	0.819	6077380
10	6-10	6x7 8x9 10x11 12x13 14x15 16x17 18x19 20x22 21x23 24x27	1.412	6077540
10	6-100	6x7 8x9 10x11 12x13 14x15 16x17 18x19 20x22 24x27 30x32	1.660	6077620
12	6-12	6x7 8x9 10x11 12x13 14x15 16x17 18x19 20x22 21x23 24x26 25x28 27x32	2.500	6077700
12	6-120	6x7 8x9 10x11 12x13 14x15 16x17 18x19 20x22 21x23 24x27 25x28 30x32	2.350	6077890
12	6-122 ISO	6x7 8x9 10x11 12x13 14x15 16x18 17x19 20x22 21x23 24x26 27x32 30x34	2.383	6078350

INCH

pieces	No.	Contents	⚖️	Code
8	6-8 A	1/4x5/16 5/16x3/8 7/16x1/2 9/16x5/8 19/32x11/16 3/4x25/32 13/16x7/8 15/16x1"	1.174	6078270
12	6-12 A	1/4x5/16 5/16x3/8 3/8x7/16 7/16x1/2 1/2x9/16 9/16x5/8 19/32x11/16 5/8x3/4 3/4x7/8 25/32x13/16 15/16x1 1.1/16x1.1/8"	1.952	6078510

## H 6 DOUBLE OPEN ENDED SPANNER SET

› H = set in robust plastic holder



H 6-8

pieces	No.	Contents	⚖️	Code
8	H 6-8	6x7 8x9 10x11 12x13 14x15 16x17 18x19 20x22	0.995	6079400
12	H 6-12	6x7 8x9 10x11 12x13 14x15 16x17 18x19 20x22 21x23 24x26 25x28 27x32	2.545	6079670
12	H 6-120	6x7 8x9 10x11 12x13 14x15 16x17 18x19 20x22 21x23 24x27 25x28 30x32	2.645	6079750

# 8 (MM) DOUBLE ENDED MIDGET SPANNER

small

- > With same size each end
- > Jaws set at 15° and 75°
- > GEDORE vanadium steel 31CrV3, heads finely polished, chrome-plated

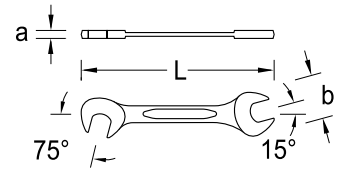

Ø mm	L	a	b	kg	Code	No.
4.0	69.0	2.2	10.4	0.005	6093900	8 4
4.5	69.0	2.2	10.4	0.006	6094040	8 4,5
5.0	77.3	2.2	12.4	0.006	6094120	8 5
5.5	77.3	2.2	12.4	0.007	6094200	8 5,5
6.0	77.3	2.2	12.4	0.008	6094390	8 6
7.0	89.5	2.6	14.8	0.011	6094470	8 7
8.0	95.5	3.1	17.5	0.016	6094550	8 8
9.0	103.8	3.1	20.2	0.020	6094630	8 9
10.0	103.8	3.1	20.2	0.021	6094710	8 10
11.0	115.2	3.1	24.0	0.028	6094980	8 11
12.0	115.2	3.1	24.0	0.028	6095010	8 12
13.0	130.5	3.1	28.0	0.037	6095280	8 13
14.0	130.5	3.1	28.0	0.038	6095360	8 14

## 8-011 DOUBLE ENDED MIDGET SPANNER SET

11 pieces

- > In plastic case



## 8-0100 DOUBLE ENDED MIDGET SPANNER SET

10 pieces

- > In blue plastic wallet



pieces	No.	Contents	kg	Code
11	8-011	4,5 5 5,5 6 7 8 9 10 11 12 13	0.280	1879146

pieces	No.	Contents	kg	Code
10	8-0100	5 5,5 6 7 8 9 10 11 12 13	0.225	6099000



## NO. 895 "BLACK DOUBLE OPEN ENDED SPANNERS" AND NO. 894 "BLACK SPANNERS"

- > Carefully forged and professionally machined
- > Jaw: ground precisely to exact nominal size for optimum contact areas
- > Overloading indicated by deformation
- > Secure grip thanks to profile shaft - very ergonomic and handy
- > Jaw set at 15°
- > GEDORE vanadium steel 31CrV3

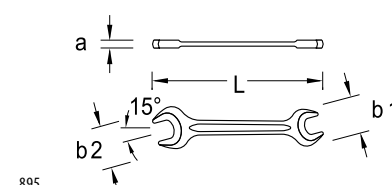
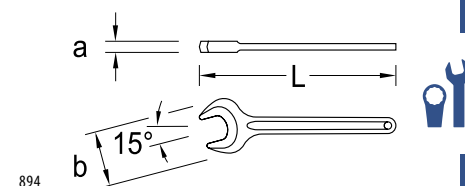

## 895 (MM) DOUBLE OPEN ENDED SPANNER

- > Acc. to DIN 895, ISO 3318, ISO 1085
- > Manganese-phosphate finish up to 34x36 mm, steel-grey up from 36x41 mm and larger
- \* not standardised

Ø mm	L	a	b <sub>1</sub>	b <sub>2</sub>	⚖ kg	Code	No.
6 x 7	96	3.2	15.0	17.0	0.014	6583830	895 6x7
7 x 8	107	3.7	17.0	19.0	0.020	6583910	895 7x8
8 x 9	108	3.7	19.0	20.5	0.023	6584130	895 8x9
8 x 10	114	4.2	19.0	22.0	0.026	6584210	895 8x10
9 x 11	* 122	5.0	20.5	24.5	0.033	6584640	895 9x11
10 x 11	124	5.0	22.0	24.5	0.034	6584720	895 10x11
10 x 12	* 128	5.0	22.0	26.5	0.037	6584800	895 10x12
10 x 13	128	5.0	22.0	28.5	0.037	6584990	895 10x13
11 x 13	140	5.5	24.5	28.5	0.049	6585100	895 11x13
12 x 13	* 140	5.5	26.5	28.5	0.053	6585370	895 12x13
12 x 14	140	5.5	26.5	30.0	0.051	6585450	895 12x14
13 x 14	* 140	5.5	28.5	30.0	0.051	6585530	895 13x14
13 x 15	154	5.5	28.5	32.0	0.065	6585610	895 13x15
13 x 15	* 154	5.5	30.0	32.0	0.054	6585880	895 14x15
13 x 17	158	6.0	28.5	36.0	0.072	6585960	895 13x17
14 x 17	158	6.0	30.0	36.0	0.076	6586180	895 14x17
16 x 17	* 158	6.0	33.0	36.0	0.072	6586260	895 16x17
17 x 19	171	7.0	36.0	40.0	0.098	6586340	895 17x19
18 x 19	* 171	7.0	38.0	40.0	0.105	6586500	895 18x19
17 x 22	* 192	8.0	36.0	46.0	0.128	6586420	895 17x22

Ø mm	L	a	b <sub>1</sub>	b <sub>2</sub>	⚖ kg	Code	No.
19 x 22	195	8.0	40.0	46.0	0.141	6586690	895 19x22
19 x 24	207	9.0	40.0	50.0	0.175	6586770	895 19x24
22 x 24	221	9.0	46.0	50.0	0.191	6587070	895 22x24
22 x 27	* 233	9.8	46.0	56.0	0.228	6587150	895 22x27
24 x 27	246	9.8	50.0	56.0	0.250	6587230	895 24x27
24 x 30	269	10.8	50.0	62.0	0.334	6587580	895 24x30
27 x 30	275	10.8	56.0	62.0	0.354	6587660	895 27x30
27 x 32	275	11.8	56.0	66.0	0.404	6587740	895 27x32
30 x 32	278	11.8	62.0	66.0	0.411	6587820	895 30x32
30 x 36	306	12.8	62.0	74.0	0.478	6587900	895 30x36
32 x 36	310	12.8	66.0	74.0	0.489	6588040	895 32x36
34 x 36	320	13.3	70.0	74.0	0.582	6583080	895 34x36
36 x 41	347	13.8	74.0	84.0	0.693	6588120	895 36x41
41 x 46	383	14.8	84.0	94.0	0.917	6588200	895 41x46
46 x 50	420	15.8	94.0	102.0	1.227	6588390	895 46x50
50 x 55	463	16.8	102.0	112.0	1.457	6588470	895 50x55
55 x 60	504	17.7	112.0	122.0	1.881	6588550	895 55x60
65 x 70	* 580	19.7	132.0	142.0	2.730	6588630	895 65x70
75 x 80	* 665	21.7	152.0	162.0	4.070	6588710	895 75x80

# 894 (MM)

## SINGLE OPEN ENDED SPANNER

- > Acc. to DIN 894, ISO 3318
- > Manganese-phosphate finish up to 38 mm, steel-grey up from 41 mm and larger
- > Sizes 10 - 135 mm with hanging hole

\* not standardised

Ø mm	L	a	b		Code	No.
6	73	3.2	15.5	0.010	6573600	894 6
7	78	3.2	17.0	0.010	6573790	894 7
8	94	3.5	19.0	0.015	6573870	894 8
9	100	4.0	20.0	0.017	6573950	894 9
10	106	4.5	22.0	0.022	6574090	894 10
11	112	5.0	24.5	0.029	6574170	894 11
12	124	5.0	26.5	0.035	6574250	894 12
13	132	5.5	28.5	0.039	6574330	894 13
14	140	5.5	30.0	0.044	6574410	894 14
15	145	5.5	32.0	0.046	6574680	894 15
16	155	5.5	33.0	0.056	6574760	894 16
17	159	6.0	36.0	0.060	6574840	894 17
18	165	6.2	38.0	0.067	6575220	894 18
19	170	7.0	40.0	0.081	6575060	894 19
22	193	8.0	46.0	0.113	6575300	894 22
24	217	9.0	50.0	0.154	6575570	894 24
25 *	217	9.0	52.0	0.142	6575650	894 25
27	239	9.8	56.0	0.199	6575810	894 27
30	263	10.8	62.0	0.249	6576380	894 30
32	275	11.8	66.0	0.374	6576540	894 32
34	290	12.3	70.0	0.365	6575730	894 34
36	305	12.8	74.0	0.392	6576700	894 36

Ø mm	L	a	b		Code	No.
38 *	305	12.8	74.0	0.406	6576890	894 38
41	344	13.8	84.0	0.568	6576970	894 41
46	380	14.8	94.0	0.704	6577000	894 46
50	413	15.8	102.0	0.956	6577190	894 50
55	459	16.8	112.0	1.125	6577270	894 55
60	494	17.7	122.0	1.439	6577350	894 60
65	528	18.7	132.0	1.686	6577430	894 65
70	572	19.7	142.0	2.111	6577510	894 70
75	610	20.7	152.0	2.782	6577780	894 75
80	645	21.7	162.0	2.905	6577860	894 80
85	690	23.0	173.0	3.895	6577940	894 85
90 *	690	23.0	173.0	3.720	6578080	894 90
95 *	847	25.0	195.0	6.335	6578160	894 95
100 *	847	25.0	195.0	6.125	6578240	894 100
105 *	1000	29.0	217.0	8.905	6578320	894 105
110 *	1000	29.0	217.0	8.650	6578400	894 110
115 *	1000	29.0	217.0	8.480	6578590	894 115
120 *	1000	29.0	220.0	8.260	6578670	894 120
125 *	1000	29.0	220.0	8.345	6576030	894 125
130 *	1000	29.0	225.0	8.230	6576110	894 130
135 *	1000	29.0	225.0	7.775	6576460	894 135

## INCH

Ø "AF	L	a	b		Code	No.
1/4	73	3.2	15.5	0.009	6579210	894 1/4AF
5/16	94	3.5	19.0	0.013	6579560	894 5/16AF
3/8	100	4.0	20.0	0.014	6579720	894 3/8AF
7/16	112	5.0	24.5	0.026	6579990	894 7/16AF
1/2	132	5.5	26.5	0.040	6580060	894 1/2AF
9/16	140	5.5	30.0	0.047	6580140	894 9/16AF
5/8	155	5.5	33.0	0.053	6580300	894 5/8AF

Ø "AF	L	a	b		Code	No.
3/4	170	7.0	40.0	0.074	6580570	894 3/4AF
13/16	170	7.0	40.0	0.074	6580730	894 13/16AF
7/8	193	8.0	46.0	0.106	6580810	894 7/8AF
15/16	217	9.0	50.0	0.147	6581030	894 15/16AF
1	217	9.0	52.0	0.156	6581110	894 1AF
1.1/16	239	10.0	56.0	0.186	6581380	894 1.1/16AF
1.1/8	239	10.0	56.0	0.205	6581460	894 1.1/8AF

## Open ended spanners

625 M  
SPANNER SET MINI

11 pieces

- > Sheet steel, hardened, bright nickel finish
- > Contents: 8 open ended spanners, 1 contact file, 1 screwdriver, 1 feeler gauge 0.40 mm



Contents		Code	No.
4 4,5 5 5,5 6 6,5 7 7,5	0.047	6524820	625 M

625 A  
SPANNER SET MINI

11 pieces

- > Sheet steel, hardened, bright nickel finish
- > Contents: 8 open ended spanners, 1 contact file, 1 screwdriver, 1 feeler gauge 0.40 mm







Contents		Code	No.
3/16 7/32 1/4 9/32 5/16 11/32 3/8 7/16"	0.053	6524900	625 A

60 CP  
ADJUSTABLE SPANNER

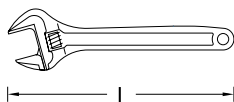
open end, chrome-plated

- > Acc. to ISO 6787
- > Jaw set at 15°
- > Swedish pattern, roller with left hand thread
- > With scale
- > Chrome-vanadium steel, chrome-plated, polished heads







Size"	L	mm 	"inch 			Code	No.
6	155	20	25/32	0-20	0.145	6380990	60 CP 6
8	205	25	1	0-25	0.270	6381020	60 CP 8
10	255	30	1.3/16	0-30	0.420	6381100	60 CP 10
12	305	36	1.7/16	0-36	0.785	6381290	60 CP 12

60 P  
ADJUSTABLE SPANNER

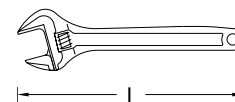
open end, phosphated

- > ISO 6787, jaw set at 15°
- > Swedish pattern, roller with left hand thread
- > With scale
- > Chrome-vanadium steel
- > Phosphate finish, polished heads



Size"	L	mm 	"inch 			Code	No.
6	155	20	25/32	0-20	0.145	6380560	60 P 6
8	205	25	1	0-25	0.295	6380640	60 P 8
10	255	30	1.3/16	0-30	0.430	6380720	60 P 10
12	305	36	1.7/16	0-36	0.705	6380800	60 P 12



# 62 P ADJUSTABLE SPANNER

open end, phosphated

- > Sturdy industrial design
- > Sizes 6" - 18" = ISO 6787, jaw set at 15°
- > Size 24" = ISO 6787, jaw set at 22,5°
- > Swedish pattern, roller with left hand thread
- > GEDORE vanadium steel 31CrV3
- > Phosphate finish, polished heads

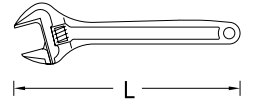

Size "	L	mm	"inch			Code	No.
6	150	20	25/32	–	0.155	2669072	62 P 6
8	200	25	1	–	0.250	2669080	62 P 8
10	250	30	1.3/16	–	0.460	2669099	62 P 10
12	300	36	1.7/16	–	0.700	2669102	62 P 12
15	380	43	1.11/16	–	1.060	6368430	62 P 15
18	455	53	2.1/16	–	1.715	6368510	62 P 18
24	610	63	2.1/2	–	3.555	6360880	62 P 24

# 60 S ADJUSTABLE WRENCH

open end

- > Acc. to ISO 6787, jaw set at 15°
- > Swedish pattern, roller with left-hand thread
- > With scale
- > The protected mechanism and additional striking face allow light blows to be applied without impairing the function of the wrench
- > Comfort 2-component handle (versions JC and JP) for fatigue-free working
- > Grip recess ensures secure hold - even with greasy hands
- > Hanging hole
- > Chrome-vanadium steel
- > Version C nickel and chrome-plated, head ground
- > Version P manganese phosphated, head ground
- > Version JP and JC complete with plastic handle



60 S 8 P



60 S 8 JP



60 S 8 C



60 S 8 JC

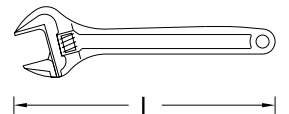

Size "	mm	mm			Code	No.
6	153.0	20	0-20	0.160	2668815	60 S 6 P
8	206.5	25	0-25	0.340	1966294	60 S 8 P
10	254.5	30	0-30	0.251	2171023	60 S 10 P
12	305.0	36	0-36	0.780	2668874	60 S 12 P
6	153.0	20	0-20	0.180	2668823	60 S 6 JC
8	206.5	25	0-25	0.360	1966308	60 S 8 JC
10	254.5	30	0-30	0.500	2171015	60 S 10 JC
12	305.0	36	0-36	0.860	2668882	60 S 12 JC

Size "	mm	mm			Code	No.
6	153.0	20	0-20	0.180	2668831	60 S 6 C
8	206.5	25	0-25	0.340	1966316	60 S 8 C
10	254.5	30	0-30	0.480	2170973	60 S 10 C
12	305.0	36	0-36	0.780	2668890	60 S 12 C
6	153.0	20	0-20	0.180	2668858	60 S 6 JC
8	206.5	25	0-25	0.360	1966324	60 S 8 JC
10	254.5	30	0-30	0.500	2171007	60 S 10 JC
12	305.0	36	0-36	0.860	2668904	60 S 12 JC

## Deep Ring Spanners

### NO. 2 A - "STRONG"

- > Heavy-duty pattern for highest torques
- > GEDORE vanadium steel 31CrV3, chrome-plated
- > **Special sizes available on request**
- > Optional accessories: No. 2 AR extension tube for extending the lever arm



No. 2A + 2 AR

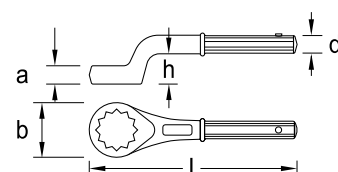

## 2 A SINGLE ENDED RING SPANNER

offset

Ø mm	L	a	b	d	h	2 AR	⚖️	Code	No.
24	180	17.4	38.0	18.3	29.0	0	0.389	6033840	2 A 24
27	190	17.4	41.5	18.3	31.5	0	0.430	6033920	2 A 27
30	200	18.4	47.0	18.3	33.0	0	0.514	6034060	2 A 30
32	235	18.4	50.0	21.3	34.0	1	0.732	6034140	2 A 32
34	235	18.4	50.0	21.3	34.0	1	0.748	6030150	2 A 34
36	245	20.0	55.0	21.3	35.0	1	0.796	6034220	2 A 36
41	265	22.0	61.5	21.3	39.0	1	0.934	6034300	2 A 41
46	280	23.0	68.5	24.1	40.0	2	1.220	6034490	2 A 46
50	290	25.5	75.0	24.1	42.0	2	1.388	6034570	2 A 50

Ø mm	L	a	b	d	h	2 AR	⚖️	Code	No.
55	300	28.0	80.0	24.1	45.0	2	1.492	6034650	2 A 55
60	345	30.5	89.0	29.1	49.0	3	2.283	6034730	2 A 60
65	355	33.0	97.0	29.1	53.0	3	2.535	6034810	2 A 65
70	365	35.5	104.0	29.1	55.0	3	2.736	6035030	2 A 70
75	375	38.0	109.0	29.1	57.5	3	2.982	6035110	2 A 75
80	385	40.5	124.0	29.1	59.0	3	3.770	6035380	2 A 80
85	385	40.5	124.0	29.1	59.0	3	3.605	6035460	2 A 85
90	410	45.0	140.0	29.1	63.0	3	4.850	6035540	2 A 90
95	410	45.0	140.0	29.1	63.0	3	4.540	6035620	2 A 95

## 2 AR EXTENSION TUBE

- > For ring spanner No. 2 A, steel tube, chrome-plated
- > For extending the lever arm and applying higher forces



Internal-Ø	Ø mm	↳ mm	⚖️	Code	No.
19	24-30	460	0.614	6048600	2 AR 0
22	32-41	610	1.568	6048790	2 AR 1
25	46-55	760	2.806	6048870	2 AR 2
30	60-95	860	3.715	6048950	2 AR 3

## 2 ATM SINGLE ENDED RING SPANNER SET

19 pieces

- > Heavy-duty pattern for highest torques
- > GEDORE vanadium steel 31CrV3, chrome-plated



Contents	⚖️	Code	No.
2 A 24 27 30 32 36 41 46 50 55 60 65 70 75 80 85 2 AR 0 1 2 3	65.0	6049250	2 ATM



## Slogging Spanners

# POWERFUL

- > Top-grade industrial quality for the hardest of continuous use
- > For very heavy-duty work

> Special sizes available on request up to size 250 mm



## 306 (MM) / 306 (AF) RING SLOGGING SPANNER

- > Acc. to DIN 7444
- > Up to length 435 mm chrome-vanadium steel 31CrV3, above 480 mm from C35
- \* not standardised

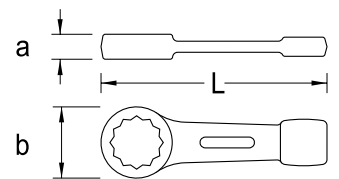

Ø mm		L	a	b	⚖️	Code	No.
22	*	165	15.0	43.0	0.220	1344331	306 22
24	*	160	15.0	42.5	0.262	6475000	306 24
27		180	15.5	47.0	0.328	6475190	306 27
30		190	16.5	51.5	0.393	6475270	306 30
32		195	16.5	53.0	0.428	6475350	306 32
34		195	16.5	53.0	0.401	6481670	306 34
36		205	19.5	60.0	0.674	6475430	306 36
38	*	205	19.5	60.0	0.635	6474460	306 38
41		225	20.5	66.0	0.790	6475510	306 41
46		240	22.5	75.0	0.999	6475780	306 46
50		250	23.5	80.0	1.093	6475860	306 50
55		270	25.0	87.5	1.452	6475940	306 55
60		270	26.0	93.5	1.577	6476080	306 60
65	⚖️	290	29.0	101.0	2.580	6476160	306 65
70		320	32.5	109.5	2.580	6476240	306 70
75		325	34.0	114.5	3.010	6476320	306 75

Ø mm		L	a	b	⚖️	Code	No.
80		345	35.0	123.0	3.515	6476400	306 80
85		360	37.0	129.0	3.895	6476590	306 85
90		400	41.5	152.0	6.370	6476670	306 90
95		400	41.5	152.0	6.285	6476750	306 95
100		400	41.5	152.0	6.030	6476830	306 100
105		435	47.5	172.0	8.660	6476910	306 105
110		435	47.5	172.0	8.440	6477050	306 110
115		435	47.5	172.0	8.160	6477130	306 115
120		480	54.0	182.0	9.855	6477210	306 120
125	*	480	54.0	182.0	9.665	6477480	306 125
130		520	58.0	202.0	12.295	6477560	306 130
135		520	58.0	202.0	11.790	6477640	306 135

## INCH

Ø"AF		L	a	b	⚖️	Code	No.
1	⚖️	160	15.0	42.5	0.262	6474540	306 1AF
1.1/16		180	15.5	47.0	0.325	6474620	306 1.1/16AF
1.1/8		180	15.5	47.0	0.315	6474700	306 1.1/8AF
1.3/16		190	16.5	51.5	0.389	6474890	306 1.3/16AF
1.1/4		190	16.5	51.5	0.386	6474970	306 1.1/4AF
1.5/16		195	16.5	53.0	0.415	6478530	306 1.5/16AF
1.3/8	⚖️	195	16.5	53.0	0.409	6478610	306 1.3/8AF
1.7/16		205	19.5	60.0	0.660	6478880	306 1.7/16AF
1.1/2		205	19.5	60.0	0.641	6478960	306 1.1/2AF
1.5/8		225	20.5	66.0	0.820	6479180	306 1.5/8AF
1.11/16		225	20.5	66.0	0.766	6479260	306 1.11/16AF
1.3/4		225	20.5	66.0	0.770	6479340	306 1.3/4AF
1.13/16		240	22.5	75.0	0.982	6479420	306 1.13/16AF
1.7/8		240	22.5	75.0	0.985	6479500	306 1.7/8AF

Ø"AF		L	a	b	⚖️	Code	No.
2		250	23.5	80.0	1.090	6479690	306 2AF
2.1/16		250	23.5	80.0	1.079	6479770	306 2.1/16AF
2.1/8		250	23.5	80.0	1.039	6479850	306 2.1/8AF
2.3/16		270	25.0	87.5	1.431	6479930	306 2.3/16AF
2.1/4		270	25.0	87.5	1.397	6480000	306 2.1/4AF
2.3/8		270	26.0	93.5	1.616	6480190	306 2.3/8AF
2.7/16		270	26.0	93.5	1.531	6480270	306 2.7/16AF
2.9/16		290	29.0	101.0	2.076	6480350	306 2.9/16AF
2.5/8		290	29.0	101.0	2.035	6480430	306 2.5/8AF
2.3/4		320	32.5	109.5	2.545	6480510	306 2.3/4AF
3		325	34.0	114.5	3.005	6480780	306 3AF

## 306 G

### RING SLOGGING SPANNER DEEP OFFSET

- > For very heavy-duty work
- > To use with club hammer or pneumatic hammer for tightening or loosening
- > Hot forged, sandblasted

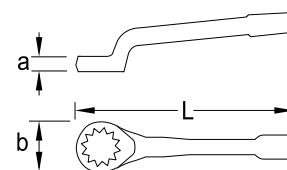

Ø mm	L	a	b	⚖️	Code	No.
27	270	25	51	1.098	1415875	306 G 27
30	270	25	51	1.080	1415913	306 G 30
32	270	25	51	1.061	1415972	306 G 32
36	310	30	67	2.010	1416014	306 G 36
41	310	30	67	1.842	1416057	306 G 41
46	340	35	79	2.950	1416111	306 G 46
50	360	40	94	4.410	1416197	306 G 50
55	360	40	94	4.155	1416227	306 G 55

Ø mm	L	a	b	⚖️	Code	No.
60	380	45	108	5.690	1416308	306 G 60
65	380	45	108	5.490	1416332	306 G 65
70	406	50	126	7.455	1416405	306 G 70
75	406	50	126	7.165	1416456	306 G 75
80	406	50	126	6.970	1416480	306 G 80
85	459	57	151	10.630	1416537	306 G 85
90	459	57	151	10.480	1416553	306 G 90
95	459	57	151	9.830	1416588	306 G 95

## 133

### OPEN ENDED SLOGGING SPANNER

- > For very heavy-duty work
- > Acc. to DIN 133
- > Up to length 500 mm chrome-vanadium steel 31CrV3, above 525 mm material C5
- > Special sizes available on request
- \* not standardised

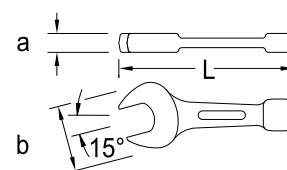

Ø mm	L	a	b	⚖️	Code	No.
27	181	16.3	56.0	0.385	6410570	133 27
30	188	16.7	62.0	0.451	6400260	133 30
32	196	17.2	66.0	0.552	6400340	133 32
34	196	17.2	66.0	0.559	6411030	133 34
36	211	18.2	76.0	0.709	6400420	133 36
41	227	19.2	88.0	1.000	6400500	133 41
46	256	19.7	98.0	1.258	6400690	133 46
50	281	21.2	106.5	1.609	6400770	133 50
55	310	23.6	117.0	2.131	6400850	133 55
60	321	24.1	128.0	2.484	6400930	133 60
65	351	27.6	139.0	3.340	6401070	133 65
70	370	29.6	150.0	4.325	6401150	133 70

Ø mm	L	a	b	⚖️	Code	No.
75	390	31.0	161.5	5.110	6401230	133 75
80	406	34.0	172.5	6.020	6401310	133 80
85	406	34.0	172.5	5.770	6401580	133 85
90	456	38.4	194.0	8.905	6401660	133 90
95	456	38.4	194.0	8.985	6401740	133 95
100	500	46.3	225.5	13.315	6401820	133 100
105	500	46.3	225.5	13.220	6401900	133 105
110	500	46.3	225.5	13.045	6402040	133 110
115	525	54.2	245.5	17.660	6402120	133 115
120	525	54.2	245.5	17.610	6402200	133 120
125	*	545	50.0	255.0	6402390	133 125
130		575	55.0	275.0	6402470	133 130

## 308

### DEEP RING SPANNER

straight pattern

- > Acc. to DIN 3111
- > Especially suited as counter-tool for screw connections
- > In heat-treated steel as per EN 10083, steel-grey
- > Further sizes available on request
- \* not standardised

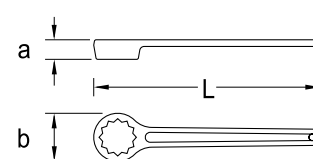

Ø mm	L	a	b	⚖️	Code	No.	
32	265	19.0	49.0	0.358	6481750	308 32	
36	*	295	22.0	56.0	0.473	6481830	308 36
41	330	25.0	63.5	0.717	6481910	308 41	
46	365	27.0	70.5	0.925	6482050	308 46	

Ø mm	L	a	b	⚖️	Code	No.	
50	400	28.0	77.0	1.230	6482130	308 50	
55	442	29.5	83.5	1.626	6482210	308 55	
60	475	30.0	89.5	1.792	6482480	308 60	
65	*	510	32.0	97.0	2.208	6482560	308 65

## Crowfoot Spanners

### SPECIAL

- > Opening at right angle to shaft for maximum accessibility
- > GEDORE vanadium steel 31CrV3, chrome-plated



## 3114 / DS 3114 CROWFOOT SPANNERS

> No. 3114 = Delivery without tommy bar

Ø mm	L	a	b	d <sub>1</sub>	d <sub>2</sub>	26 D	⚖ kg	Code	No.
13	160	5.5	28.0	8.5	13.8	8	0.095	6670050	3114 13
14	160	5.5	28.0	8.5	13.8	8	0.093	6670130	3114 14
16	200	6.0	33.0	10.5	16.8	10	0.160	6676920	3114 16
17	200	6.0	33.0	10.5	16.8	10	0.169	6670210	3114 17
18	200	7.0	37.0	12.5	19.6	12	0.216	6677060	3114 18
19	200	7.0	37.0	12.5	19.6	12	0.224	6670480	3114 19
21	200	8.0	42.0	12.5	19.6	12	0.272	6677140	3114 21

Ø mm	L	a	b	d <sub>1</sub>	d <sub>2</sub>	26 D	⚖ kg	Code	No.
22	200	8.0	42.0	12.5	19.6	12	0.265	6670560	3114 22
24	250	9.0	46.0	14.5	23.6	14	0.419	6670640	3114 24
27	250	10.0	52.0	14.5	23.6	14	0.519	6670720	3114 27
30	250	11.0	57.0	16.5	27.6	16	0.633	6670800	3114 30
32	250	11.8	61.0	16.5	27.6	16	0.712	6670990	3114 32
36	315	12.8	68.0	19.0	31.5	18	1.034	6671020	3114 36

> No. DS 3114 = Delivery with tommy bar 26 D

Ø mm	L	a	b	d <sub>1</sub>	d <sub>2</sub>	26 D	⚖ kg	Code	No.
13	160	5.5	28.0	8.5	13.8	8	0.168	6672180	DS 3114 13
14	160	5.5	28.0	8.5	13.8	8	0.168	6672260	DS 3114 14
16	200	6.0	33.0	10.5	16.8	10	0.280	6677220	DS 3114 16
17	200	6.0	33.0	10.5	16.8	10	0.286	6672340	DS 3114 17
18	200	7.0	37.0	12.5	19.6	12	0.436	6677300	DS 3114 18
19	200	7.0	37.0	12.5	19.6	12	0.440	6672420	DS 3114 19
21	200	8.0	42.0	12.5	19.6	12	0.482	6677490	DS 3114 21
22	200	8.0	42.0	12.5	19.6	12	0.486	6672500	DS 3114 22

Ø mm	L	a	b	d <sub>1</sub>	d <sub>2</sub>	26 D	⚖ kg	Code	No.
24	250	9.0	46.0	14.5	23.6	14	0.798	6672690	DS 3114 24
27	250	10.0	52.0	14.5	23.6	14	0.902	6672770	DS 3114 27
30	250	11.0	57.0	16.5	27.6	16	1.256	6672850	DS 3114 30
32	250	11.8	61.0	16.5	27.6	16	1.324	6672930	DS 3114 32
36	315	12.8	68.0	19.0	31.5	18	2.016	6673070	DS 3114 36

## 26 D TOMMY BAR

- > Acc. to DIN 900 Form A
- > GEDORE vanadium steel 31CrV3, chrome-plated up to Ø 20 mm



Ø	↳ mm ↲	⚖ kg	Code	No.
6	157	0.040	6208580	26 D 6
8	177	0.073	6208740	26 D 8
10	197	0.127	6208820	26 D 10
12	246	0.228	6208900	26 D 12

Ø	↳ mm ↲	⚖ kg	Code	No.
14	316	0.386	6209040	26 D 14
16	396	0.634	6209120	26 D 16
18	495	0.995	6209200	26 D 18
20	625	1.555	6209390	26 D 20

## Swivel Head Wrenches

534  
COMBINATION SWIVEL HEAD  
WRENCH

- > Slim pattern, with free moving socket wrench
- > With hole for tommy bars 26 D and 26 RS (please order separately)
- > GEDORE vanadium steel 31CrV3, heads polished, chrome-plated

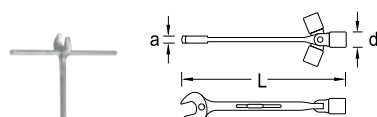

mm	L	a	d	26 D	26 RS	kg	Code	No.
10	179	4.7	15.5	–	1	0.071	6512060	534 10
11	189	5.0	16.7	–	1	0.087	6512140	534 11
12	198	5.3	18.0	–	1	0.115	6512220	534 12
13	208	6.0	19.2	–	1	0.140	6512300	534 13
14	218	6.3	20.5	6	1	0.151	6512490	534 14
15	231	6.7	21.7	6	1	0.169	6512570	534 15
16	244	7.0	22.9	6	1	0.222	6512650	534 16
17	255	7.5	24.2	8	2	0.237	6512730	534 17
18	269	7.7	25.5	8	2	0.273	6513030	534 18
19	283	8.0	26.7	8	2	0.304	6512810	534 19

34  
SWIVEL HEAD WRENCH  
DOUBLE ENDED

- > Thin walled heads, UD profile
- > Swivels through a wide radius
- > Shaft with holes for tommy bars 26 D and 26 RS (please order separately)
- > GEDORE vanadium steel 31CrV3, heads polished, chrome-plated

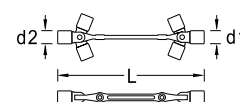

mm	L	d <sub>1</sub>	d <sub>2</sub>	26 D	26 RS	kg	Code	No.
6 x 7	190	10.2	11.5	6	1	0.089	6301520	34 6x7
8 x 9	200	13.0	14.2	6	1	0.098	6299010	34 8x9
10 x 11	205	15.5	16.7	6	1	0.110	6299280	34 10x11
12 x 13	240	18.0	19.2	8	2	0.204	6299360	34 12x13
13 x 17	275	19.2	24.2	10	2	0.318	6299600	34 13x17
14 x 15	245	20.5	21.7	8	2	0.216	6299520	34 14x15
16 x 17	280	22.9	24.2	10	2	0.334	6299870	34 16x17
17 x 19	315	24.2	26.7	12	3	0.411	6299950	34 17x19
18 x 19	315	25.5	26.7	12	3	0.418	6300040	34 18x19
20 x 22	350	28.0	30.5	12	3	0.604	6300120	34 20x22
21 x 23	350	29.2	31.7	12	3	0.633	6300200	34 21x23
24 x 27	410	33.0	36.7	14	3	0.913	6300390	34 24x27
30 x 32	470	40.5	43.0	14	3	1.361	6300470	34 30x32

IN 34  
SWIVEL HEAD WRENCH  
DOUBLE ENDED

for in-hex screws

- > Shaft with holes for tommy bars 26 D and 26 RS (please order separately)
- > Swivel through a wide radius
- > Sockets in GEDORE chrome-molybdenum steel 42CrMo4, phosphated, shaft chrome-plated

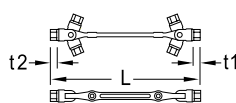

mm	L	t <sub>1</sub>	t <sub>2</sub>	26 D	26 RS	kg	Code	No.
3 x 4	198	4.0	5	6	1	0.101	6302250	IN 34 3x4
5 x 6	202	5.0	6	6	1	0.107	6302330	IN 34 5x6
8 x 10	235	8.0	10	8	2	0.199	6302410	IN 34 8x10
12 x 14	270	10.0	12	10	2	0.336	6302680	IN 34 12x14
17 x 19	295	14.0	16	12	3	0.411	6302760	IN 34 17x19

1500 ES-534

&gt;99



1500 CT1-534

&gt;107



## Socket Wrenches

### 25 SOCKET WRENCHES

offset

- > Solid pattern with extra deep socket for protruding bolts
- > GEDORE vanadium steel 31CrV3, chrome-plated
- > With dome for pointed screw heads

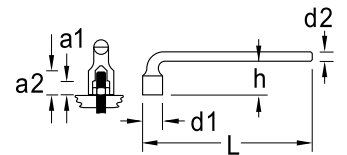
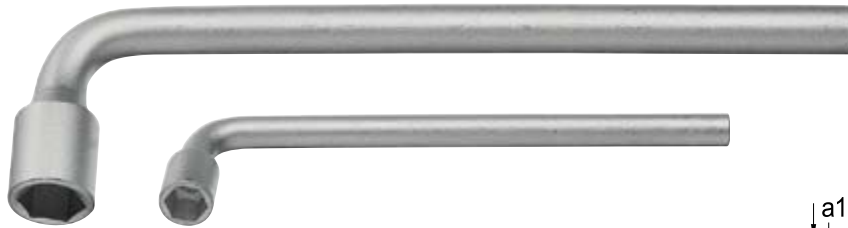

Ø mm	L	a <sub>1</sub>	a <sub>2</sub>	d <sub>1</sub>	d <sub>2</sub>	h	kg	Code	No.
10	160	9.6	16.5	15,0	10	32	0.120	6188290	25 10
13	200	12.7	23.0	19,0	12	41	0.220	6188530	25 13
17	250	12.0	26.0	25,0	14	49	0.373	6188880	25 17
19	280	15.4	29.0	27,5	16	56	0.539	6188960	25 19
22	315	16.4	32.5	32,0	18	64	0.797	6189180	25 22
24	345	19.5	37.1	34,5	20	71	1.055	6189260	25 24
27	380	21.4	37.5	38,5	20	74	1.179	6189340	25 27
30	420	22.3	41.3	42,0	22	84	1.536	6189420	25 30
36	500	27.3	47.1	50,0	26	97	2.523	6189690	25 36

### 25 V SOCKET WRENCHES

offset

- > Solid pattern with extra deep socket for protruding bolts
- > GEDORE vanadium steel 31CrV3, chrome-plated

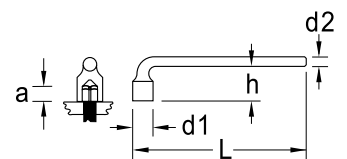

Ø mm	L	a	d <sub>1</sub>	d <sub>2</sub>	h	kg	Code	No.
8	150	11.0	15,0	10	32.0	0.116	6194770	25 V 8
9	160	11.0	16,5	10	35.0	0.126	6194850	25 V 9
10	175	12.0	19,0	12	37.5	0.203	6194930	25 V 10
12	215	14.5	22,0	14	44.0	0.335	6195150	25 V 12
13	230	20.5	23,5	14	47.0	0.357	6195230	25 V 13
14	240	21.5	25,0	14	49.0	0.378	6195310	25 V 14
17	280	26.5	30,0	18	62.0	0.718	6195580	25 V 17



## 25 PK DOUBLE ENDED SOCKET WRENCH

offset with hole

- > Solid pattern with two hexagon heads
- > Deep bores above the hexagon heads to take long studs
- > Through-hole on the angled side to take a tommy bar (e.g. 26 D, please order separately)
- > Chrome-plated

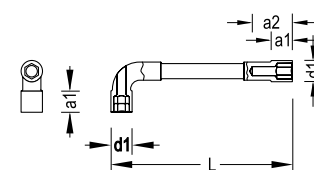

Ø mm	L	a <sub>1</sub>	a <sub>2</sub>	d <sub>1</sub>	26 D	⚖ kg	Code	No.
6	105	9	26.5	13,0		0.080	1616323	25 PK 6
7	107	9	26.5	14,0		0.081	1616331	25 PK 7
8	112	10	26.5	14,0		0.091	1616358	25 PK 8
9	120	10	26.5	14,0		0.099	1436805	25 PK 9
10	130	10	23.0	15,5	6	0.116	1436813	25 PK 10
11	136	10	23.0	16,5	6	0.122	1436821	25 PK 11
12	145	10	37.0	18,5	6	0.166	1436848	25 PK 12
13	152	11	35.0	20,0	8	0.192	1436856	25 PK 13
14	160	12	38.0	21,0	8	0.216	1436864	25 PK 14
15	170	13	38.0	22,5	8	0.239	1616366	25 PK 15
16	178	15	34.0	24,0	8	0.275	1436872	25 PK 16

Ø mm	L	a <sub>1</sub>	a <sub>2</sub>	d <sub>1</sub>	26 D	⚖ kg	Code	No.
17	187	15	35.0	25,5	8	0.305	1436899	25 PK 17
18	195	18	39.0	26,5	10	0.385	1436902	25 PK 18
19	205	17	38.0	28,0	12	0.440	1436910	25 PK 19
21	225	18	47.0	32,0	12	0.620	1436929	25 PK 21
22	225	18	47.0	32,0	12	0.632	1436937	25 PK 22
24	248	22	37.0	35,5	12	0.814	1436945	25 PK 24
27	280	26	60.0	38,0	16	1.088	1436953	25 PK 27
30	310	27	64.0	42,0	18	1.500	1436961	25 PK 30
32	330	30	63.0	45,0	20	1.475	1436988	25 PK 32
34	340	32	67.0	47,0	20	1.580	1436996	25 PK 34
36	355	33	74.0	50,0	20	2.052	1437003	25 PK 36

26 D

&gt;144



2005 CT2-25PK

&gt;114

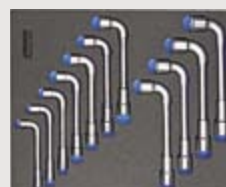

## 25 PK-012 DOUBLE ENDED SOCKET WRENCH SET

12 pieces

- > Solid pattern with two hexagon heads
- > Deep bores above the hexagon heads to take long studs
- > Through-hole on the angled side to take a tommy bar
- > Chrome-plated



Contents

8 9 10 11 12 13 14 15 16 17 18 19

⚖ kg

2.578

Code

1527312

No.

25 PK-012

## Tubular box spanners

# 626 TUBULAR BOX SPANNER

heavy-duty pattern



- > Similar to DIN 896, Form A, ISO 2236, ISO 1085
- > With hexagon shaft and holes for turning, either with a spanner or a tommy bar (626 S / 26 RS-626 S, see table, please order separately)
- > Sizes 6x7 and 8x9 mm with no hole
- > GEDORE vanadium steel 31CrV3, chrome-plated

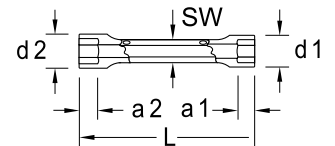

Ø mm	L	a <sub>1</sub>	a <sub>2</sub>	d <sub>1</sub>	d <sub>2</sub>	SW ● mm	26 RS-626 S	$\frac{kg}{kg}$	Code	No.
6 x 7	105	6.0	7.0	9.5	10.5	8	626 S 1	0.037	6525120	626 6x7
8 x 9	110	7.0	8.0	12.0	13.0	9	626 S 1	0.052	6525200	626 8x9
10 x 11	120	9.0	9.5	14.5	16.0	11	626 S 1	0.072	6525390	626 10x11
12 x 13	140	10.5	11.0	17.0	18.5	13	626 S 1	0.117	6525470	626 12x13
13 x 17	155	11.0	14.0	18.5	23.0	15	626 S 2	0.160	6520750	626 13x17
14 x 15	145	11.5	13.0	19.5	21.0	14	626 S 1	0.145	6525710	626 14x15
16 x 17	155	13.0	14.0	22.0	23.0	16	626 S 2	0.189	6526280	626 16x17
17 x 19	165	14.0	17.5	23.0	26.0	18	626 S 2	0.233	6526360	626 17x19
18 x 19	165	15.0	17.5	24.5	26.0	18	626 S 2	0.242	6526440	626 18x19
19 x 22	175	17.5	18.5	26.0	30.0	19	626 S 2	0.288	6526520	626 19x22
20 x 22	175	17.5	18.5	27.5	30.0	19	626 S 2	0.306	6526600	626 20x22
24 x 26	195	21.5	23.5	32.5	34.5	24	26 RS-626 S-3	0.452	6526870	626 24x26
24 x 27	195	21.5	23.5	32.5	36.0	24	26 RS-626 S-3	0.493	6526950	626 24x27
30 x 32	210	25.0	29.0	39.5	42.5	30	26 RS-626 S-3	0.725	6527170	626 30x32
32 x 36	225	29.0	30.5	42.5	48.0	32	26 RS-626 S-3	0.898	6527250	626 32x36

# 626 S STEPPED TOMMY BAR



626 S 1

- > GEDORE vanadium steel 31CrV3, chrome-plated, tempered

Ø <sub>1</sub>	Ø <sub>2</sub>	Ø <sub>3</sub>	Ø <sub>4</sub>	Ø <sub>5</sub>	l mm	$\frac{kg}{kg}$	Code	No.
3,7	4,7	5.2	7.0		190	0.050	6528060	626 S 1
6,7	7,7	8.7	9.7	11.0	240	0.159	6528140	626 S 2
11,7	13,7	16.0			310	0.492	6528220	26 RS-626 S-3

# KD 626 TUBULAR BOX SPANNER SET

with tommy bars

- > Similar to DIN 896, Form A, ISO 2236, ISO 1085
- > With hexagon shaft and holes for turning, either with a spanner or a tommy bar (626 S / 26 RS-626 S)
- > Sizes 6x7 and 8x9 mm with no hole
- > GEDORE vanadium steel 31CrV3, chrome-plated



pieces	Contents	$\frac{kg}{kg}$	Code	No.
8	626 6x7 8x9 10x11 12x13 14x15 16x17 18x19 20x22 626 S 1 2	1.434	6528730	KD 626-8
10	626 6x7 8x9 10x11 12x13 14x15 16x17 18x19 20x22 24x27 30x32 626 S 1 2 26 RS-626 S-3	3.080	2803550	KD 626-10

## 26 R TUBULAR BOX SPANNER

- > Acc. to DIN 896 Form B, ISO 2236, ISO 1085
- > Hollow shaft, in tubular steel, DIN 2391 seamless, hardened, made from material C35, chrome-plated

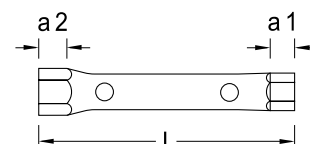

Ø mm	L	a <sub>1</sub>	a <sub>2</sub>	26 D	26 RS		Code	No.
<b>5,5 x 7</b> *	105	5.0	6.0	6	1	0.036	6222810	26 R 5,5x7
<b>6 x 7</b>	105	5.0	6.0	6	1	0.035	6210050	26 R 6x7
<b>8 x 9</b>	105	6.0	7.0	6	1	0.041	6210210	26 R 8x9
<b>8 x 10</b>	120	6.0	7.5	6	1	0.049	6210480	26 R 8x10
<b>9 x 10</b> *	120	7.0	7.5	6	1	0.050	6210560	26 R 9x10
<b>10 x 11</b>	120	7.5	8.0	6	1	0.055	6210640	26 R 10x11
<b>10 x 13</b>	140	7.5	9.5	8	2	0.072	6210720	26 R 10x13
<b>11 x 13</b>	140	8.0	9.5	8	2	0.074	6210800	26 R 11x13
<b>12 x 13</b>	140	9.0	9.5	8	2	0.073	6210990	26 R 12x13
<b>12 x 14</b>	140	9.0	10.0	8	2	0.083	6211020	26 R 12x14
<b>13 x 14</b> *	140	9.5	10.0	8	2	0.083	6211100	26 R 13x14
<b>13 x 15</b> *	140	9.5	11.0	8	2	0.089	6211290	26 R 13x15
<b>14 x 15</b>	140	10.0	11.0	8	2	0.088	6211370	26 R 14x15
<b>13 x 17</b>	150	9.5	12.0	10	2	0.139	6211450	26 R 13x17
<b>14 x 17</b>	150	10.0	12.0	10	2	0.140	6211530	26 R 14x17
<b>16 x 17</b>	150	11.0	12.0	10	2	0.139	6211610	26 R 16x17
<b>16 x 18</b>	150	11.0	13.0	10	2	0.152	6223030	26 R 16x18
<b>17 x 19</b>	155	12.0	15.0	12	3	0.161	6211880	26 R 17x19

- > With hole for tommy bars 26 D and 26 RS (please order separately)
- \* not standardised

## 26 RS STEPPED TOMMY BAR

- > GEDORE vanadium steel 31CrV3, chrome-plated, fully hardened



Ø <sub>1</sub>	Ø <sub>2</sub>	Ø <sub>3</sub>	l mm		Code	No.
<b>5,0</b>	6,0		190	0.045	6219350	26 RS 1
<b>8,0</b>	10,0		240	0.149	6219430	26 RS 2
<b>11,7</b>	13,7	16,0	310	0.492	6528220	26 RS-626 S-3

## KD 26 R TUBULAR BOX SPANNER SET

with tommy bars

- > Hollow shaft, in tubular steel, DIN 2391 seamless, hardened, made from material C35, chrome-plated



pieces	Contents		Code	No.
<b>8</b>	26 R 6x7 8x9 10x11 12x13 14x15 16x17 18x19 20x22 26 RS 1 2 3	1.564	6218540	KD 26 R-8
<b>12</b>	26 R 6x7 8x9 10x11 12x13 14x15 16x17 18x19 20x22 21x23 24x27 25x28 30x32 26 RS 1 2 3	2.895	6218890	KD 26 R-120

## Multi fitting keys

### 45 P PROFI-KEY UNIVERSAL

- > Key for opening and closing of technical shut-off systems e.g. air-conditioning, revision systems
- > For the outdoor areas - locking of bins or waste containers, and street lamp lids etc.
- > With bit insert: slotted head 1.0 x 7 mm and cross-head PH 2 with adapter for 1/4" bits on securing chain
- > 5 mm square for radiator valves
- > Stepped key with 6, 7, 8, 9 mm square
- > Female square 5, 6, 7-8 mm
- > Female three-square 9 mm
- > Dimensions: 90 x 62 mm
- > Zinc die-casting

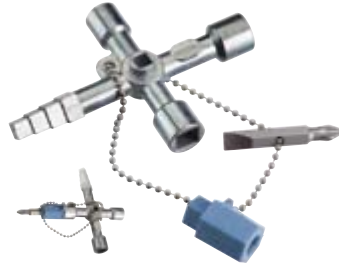

Measurements		Code	No.
90 x 62	0.080	2190117	45 P



### 45 S MULTI FITTING MASTER KEY UNIT

- > Key for opening and closing of master cabinets, switch panels, technical shut-off systems e.g. air-conditioning, revision systems
- > For the outdoor areas - locking of bins or waste containers, and street lamp lids etc.
- > Supplied with bit insert: slotted head 1.0 x 7 mm and cross-head PH 2 with adapter for 1/4" bits on securing chain
- > 5 mm square for radiator valves
- > Female square 5, 6, 7-8 mm



Measurements		Code	No.
72 x 72	0.080	2190125	45 S



### 45 U MULTI FITTING KEY UNIVERSAL

- > For all usual technical shut-off systems
- > 1 tool for 9 applications
- > 8 different master cabinet shut-off systems and 5 mm square for radiator valves
- > Flat construction due to space-saving swivel mechanism
- > Square locking: 5, 6, 7-8, 9-10 mm
- > Three-edged locking: 7, 8-9, 10-11 mm
- > Two-way-key 3-5 mm and half-moon locking 6 mm
- > Securing chain with snap-hook
- > Dimensions: 95 x 95 mm
- > Zinc die-casting



Measurements		Code	No.
95 x 95	0.204	2294826	45 U

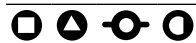

### 45 E MULTI FITTING KEY ELECTRO

- > For all usual electric master cabinets
- > Space-saving, double swivel mechanism
- > 5 mm square for radiator valves
- > Female square 5, 6, 7-8 mm
- > Female three-square 9 mm
- > Two-way-key 3 - 5 mm
- > Magnetic bit adaptor 1/4", supplied with one bit PH 2
- > Screwdriver function with retaining clip



Measurements		Code	No.
145	0.120	2294796	45 E

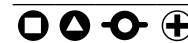

## Hook Spanners

### 40 HOOK WRENCH with lug



- > Acc. to DIN 1810, Form A
- > For slotted round nuts according to DIN 981
- > GEDORE vanadium steel 31CrV3, manganese-phosphated

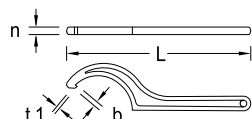

	L	b	n	t <sub>1</sub>		Code	No.
0.026	110	2.0	3.8	1.5	0.026	6333990	40 16-20
0.038	135	2.5	4.5	2.0	0.038	6334020	40 25-28
0.043	135	2.5	4.5	2.0	0.043	6334100	40 30-32
0.071	170	3.0	5.5	2.5	0.071	6334290	40 34-36
0.078	170	3.0	5.5	2.5	0.078	6334370	40 40-42
0.133	205	3.5	6.5	3.0	0.133	6334450	40 45-50
0.130	205	3.5	6.5	3.0	0.130	6334530	40 52-55
0.196	240	4.0	7.5	3.5	0.196	6334610	40 58-62
0.208	240	4.0	7.5	3.5	0.208	6334880	40 68-75
0.282	280	5.0	8.5	4.0	0.282	6334960	40 80-90
0.275	280	5.0	8.5	4.0	0.275	6335180	40 95-100
0.491	335	5.0	10.3	4.0	0.491	6335260	40 110-115
0.493	335	5.0	10.3	4.0	0.493	6335340	40 120-130
0.841	385	6.0	12.3	5.0	0.841	6335420	40 135-145
0.820	385	6.0	12.3	5.0	0.820	6335500	40 155-165
1.445	465	6.0	14.3	5.0	1.445	6335690	40 180-195
1.448	465	6.0	14.3	5.0	1.448	6335770	40 205-220

## 40 Z HOOK WRENCH

with pin

- > Acc. to DIN 1810, Form B
- > For cross-drilled nuts according to DIN 1816
- > GEDORE vanadium steel 31CrV3, manganese-phosphated

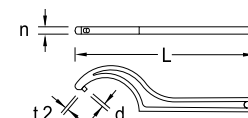

∅ mm	L	d	n	t <sub>2</sub>	⚖ kg	Code	No.
16-18	110	2.5	3.8	2.5	0.014	6335850	40 Z 16-18
20-22	110	2.5	3.8	2.5	0.014	6335930	40 Z 20-22
25-28	135	3.0	4.5	3.0	0.039	6336580	40 Z 25-28
30-32	135	4.0	4.5	3.0	0.045	6336660	40 Z 30-32
34-36	170	4.0	5.5	3.5	0.080	6336740	40 Z 34-36
40-42	170	4.0	5.5	3.5	0.079	6336820	40 Z 40-42
45-50	205	5.0	6.5	4.0	0.136	6336900	40 Z 45-50
52-55	205	5.0	6.5	4.0	0.129	6337040	40 Z 52-55
58-62	240	5.0	7.5	5.0	0.198	6337120	40 Z 58-62
68-75	240	6.0	7.5	5.0	0.198	6337200	40 Z 68-75

∅ mm	L	d	n	t <sub>2</sub>	⚖ kg	Code	No.
80-90	280	6.0	8.5	6.0	0.281	6337390	40 Z 80-90
95-100	280	8.0	8.5	6.0	0.276	6337470	40 Z 95-100
110-115	335	8.0	10.3	8.0	0.494	6337550	40 Z 110-115
120-130	335	8.0	10.3	8.0	0.492	6337630	40 Z 120-130
135-145	385	8.0	12.3	8.0	0.829	6337710	40 Z 135-145
155-165	385	8.0	12.3	8.0	0.841	6337980	40 Z 155-165
180-195	465	10.0	14.3	8.0	1.420	6338010	40 Z 180-195
205-220	465	10.0	14.3	8.0	1.402	6338280	40 Z 205-220

## 44 CALIPER FACE SPANNER

adjustable

- > Similar to DIN 3116
- > Special sizes on request
- > GEDORE vanadium steel 31CrV3, manganese-phosphated

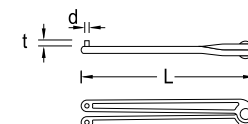

∅ mm	L	L"	d	t	⚖ kg	Code	No.
3	178	7	2.9	4	0.148	6354480	44 3
4	178	7	3.8	5	0.151	6354560	44 4
5	230	9	4.8	6	0.259	6354640	44 5

∅ mm	L	L"	d	t	⚖ kg	Code	No.
6	230	9	5.8	7	0.260	6354720	44 6
8	230	9	7.8	8	0.265	6354990	44 8

### Accessories

## 637 RETAINING CLIP FOR NUTS

- > With magnetic holder
- > Suitable for open ended and flat ring spanners size 10-19 mm
- > Delivery without tools and accessories



⚖ kg	Code	No.
0.006	1834150	637

## 639 COMBINATION HOLDING TOOL

- > Small helper to hold nuts and washers in barely accessible places
- > For thread sizes from M3 to M8
- > Delivery without tools and accessories



L	W	H	⚖ kg	Code	No.
110	19.2	9.7	0.016	1640852	639





# SOCKETS AND ACCESSORIES

**6,3 (1/4")**  
SQUARE DRIVE  
>160



**10 (3/8")**  
SQUARE DRIVE  
>176



**12,5 (1/2")**  
SQUARE DRIVE  
>192



**20 (3/4")**  
SQUARE DRIVE  
>219



**25 (1")**  
SQUARE DRIVE  
>226



**FRICTION TYPE RATCHETS**  
>230



**IMPACT TOOLS**  
>233



**BIT RANGE**  
>251



# POWERFUL RATCHETS AND STURDY SOCKETS

Powerful, reliable, durable

A huge variety of types

- › Intelligently designed **ratchets** meet every demand placed and more besides.
- › Sturdy, fine-toothed, durable and extremely resilient
- › Top-grade industrial quality for the hardest of continuous uses
- › Unrivalled diversity of hot-forged **sockets**, metric, inch, TORX®, multi-tooth, internal hexagon or slot and cruciform
- › Screw head protecting profiles (UD bi-hexagonal and hexagonal)

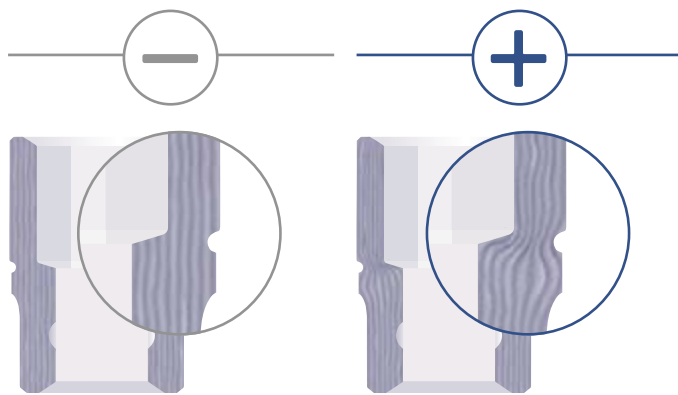

**cold forged**  
Fibers are bent and thus not as stable

**hot forged**  
Fibers are not interrupted

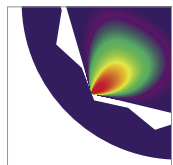

Quality from A - Z...

- › Use of the best-possible raw materials, most up-to-date machinery and environmentally-friendly production processes
- › Our tool specialists vouch for exactness in processing and continuous refinements
- › Unique manufacturing processes and special tool treatment bring about the best in results
- › Stringent quality checks after each production step ensure a constantly high level





### Maximum quality socket sets

- > Innovative, functional design
- > Are blue-hammer finished and from GEDORE
- > Maximum resilience of the sockets and robustness of the drive parts have turned "GEDORE sockets sets" into a household name internationally
- > A name known on the tool market for many years now
- > The sturdy and secure way to keep and carry your tools



### From precision mechanics to heavy industry

- > GEDORE operating tools and accessories for professional tool use in each and every industry
- > For heavy continuous use and safety in everyday work
- > Available individually or in practical set compilations, in the module or in sets
- > Customised manufacturing on request



# U-20 RATCHETS

## DESIGN-ORIENTED PREMIUM RATCHETS

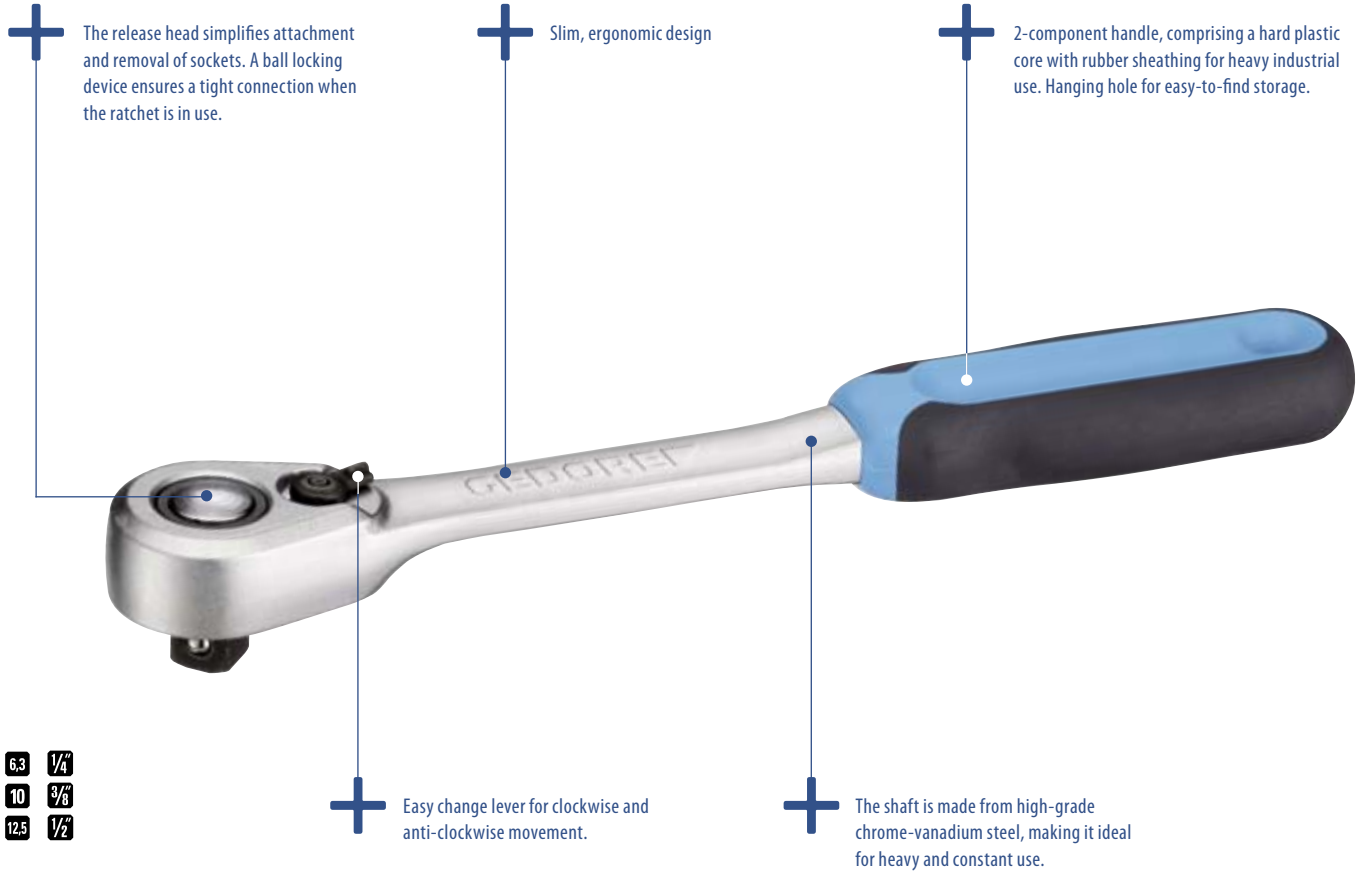

+ The release head simplifies attachment and removal of sockets. A ball locking device ensures a tight connection when the ratchet is in use.

+ Slim, ergonomic design

+ 2-component handle, comprising a hard plastic core with rubber sheathing for heavy industrial use. Hanging hole for easy-to-find storage.

6.3	1/4
10	3/8
12.5	1/2

+ Easy change lever for clockwise and anti-clockwise movement.

+ The shaft is made from high-grade chrome-vanadium steel, making it ideal for heavy and constant use.

## MANUFACTURING PROCESS





















































Front

Rear











Type of ratchet/Drive 6.3 1/4" 10 3/8" 12.5 1/2" 20 3/4" 25 1"

**Reversible ratchets** **Reversible ratchets (X)XL**

	<b>Reversible ratchet for short sockets</b>			1993 U-20 SK 				
	<b>Reversible ratchet with push-button release and lever change</b>	2093 U-20 	3093 U-20 	1993 U-20 				
	<b>Reversible ratchet offset with push-button release and lever change</b>			1993 U-20 G 				
	<b>Reversible ratchet with control lever with centre locking</b>	2093 U-10 	3093 U-10 			3293 U-10 	2193 U-10 	<b>Reversible ratchet with control lever</b> 
	<b>Reversible ratchet with push-button release and lever change with centre locking</b>			1993 U-10 T 				
	<b>Reversible ratchet with push-button release and lever change with centre locking</b>			1993 U-10 L 				
	<b>Aluminium reversible ratchet with push-button release and lever change with centre locking</b>		3093 ALU-10 	1993 ALU-10 				
	<b>Reversible ratchet with metal disc change</b>	2093 U-3 	3093 U-3 	1993 U-3 		3293 U-3 	2193 U-3 	<b>Reversible ratchet with metal disc change</b> 
						3293 U-2 		<b>Reversible ratchet with metal disc change</b> 
	<b>Swivel-head reversible ratchet with metal disc change</b>		3093 GU-3 	1993 GU-3 				
	<b>Swivel-head reversible ratchet with lever change and push-button release</b>			1993 GU-10XL 				
	<b>Ratchet handle with square coupler</b>	2093 Z-94 	3093 Z-94 	1993 Z-94 		3293 Z-94 	2193 Z-94 	

**Exclusive GEDORE ratchets**

	Friction-type ratchet			31 KR, 31 KVR 29, 31 K 41V-418V				
	Hand ratchet	2093 HR-94 						
	T-handle ratchet	2093 U-3T 	3093 U-3T 					
	Plastic ratchet			1993 U-10K 				



# MANUFACTURING PROCESS FOR SOCKETS



**1**  
Blank cropped to size from 31CrV3



**2**  
Hot forged in the forging press.



**3**  
Accurately cropped to size.



**4**  
Outside diameter turned and knurled. For this step and the next, GEDORE uses high-tech machinery from its in-house mechanical engineering department.



**5**  
Counterbored, square socket drive is fluted (ball-stop flute), manufacturer and socket size are permanently stamped.



**6**  
Degreased, since grease would destroy the protective gas atmosphere in hardening.



**7**  
Hardened under protective gas atmosphere, followed by annealing.



**8**  
Sand blasted in preparation for surface coating.



**9**  
Nickel-plated and matt-chrome-plated to prevent dazzle. The electrolytically applied nickel coating ensures corrosion protection. The electroplated chrome improves the look and gives the socket a perfect finish.

## Pro GEDORE

- > Use of high alloy 31CrV3 steel
- > Heat formed sockets which have a wear resistant, fine-grained structure and have a long service life
- > Narrow production tolerances ensure an ideal load transmission and low wear and guarantee a long service life
- > Distinctive ball catch ensure secure fit on the square drive
- > Good grip due to deep knurling even when held with oily hands or when working with protective gloves
- > Good look due to chrome plating and varnishing
- > Broad range in all sizes, drive and drive-side and for a wide range of screw types. One of the most diverse ranges in the market.

(\*) Not applicable to 1/4" hexagonal sockets

Like all hot-forged tools, GEDORE sockets (\*) are characterised by their homogeneous structure. The fibres run in parallel with the contour of the tool. The uninterrupted fibre orientation prevents residual stresses in the structure. In cold-forged tools, the fibres or lines of stress may deviate. Fibre orientation is equally important in nature.

For example, in a tree, the soft fibre orientation is parallel to the branch, so the wood is resistant to bending and twisting. If fibres become kinked, the branch loses its stability at the kink point and breaks. The low-stress GEDORE sockets withstand suddenly occurring peak forces better than cold formed sockets.







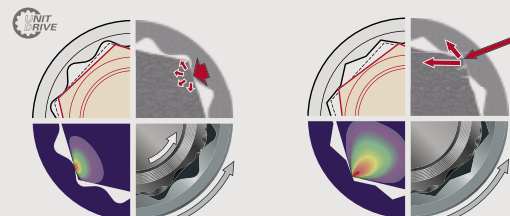



















(\*) Not applicable to 1/4" hexagonal sockets

## UNIT-DRIVE PROFIL

>154





																								
		mm	mm	AF	AF	mm	mm	AF	mm															
6,3		L	○	● 4-14	● 3/16-9/16	○	○	● 4-14	● 3/16-9/16	● 2-8	● T8-T40	○	● E4-E10	○	● 4-8	● 1-4	● 1-4	● T10-T40	● K4-K6	○				
		K	○	○	● 3/16-1/2	○	○	● 4-13	● 3/16-1/2	○	● 3-8	○	○	○	○	○	○	○	○	○	○			
10		L	● 6-24	● 6-24	● 1/4-1	● 1/4-7/8	○	○	○	○	● 4-10	● T20-T50	● T20-T40	● E4-E10	● 5-10	● 5,5-12	● 1-3	● 1-3	○	○	● 1/5-3/8			
		K	○	○	○	○	○	○	○	○	○	○	○	○	○	○	○	○	○	○	○	○		
12,5		L	● 8-36	● 8-36	● 5/16-11/4	○	● 3/16-3/4W	○	○	○	○	○	○	○	○	○	○	○	○	○	○	○		
		K	○	○	○	○	○	○	○	○	○	○	○	○	○	○	○	○	○	○	○	○	○	
15		L	● 10-34	● 10-34	● 1/2-15/16	○	○	○	○	○	○	○	○	○	○	○	○	○	○	○	○	○		
		K	○	○	○	○	○	○	○	○	○	○	○	○	○	○	○	○	○	○	○	○	○	
20		L	● 18-60	● 18-60	● 7/8-2	○	○	○	○	○	○	○	○	○	○	○	○	○	○	○	○	○		
		K	○	○	○	○	○	○	○	○	○	○	○	○	○	○	○	○	○	○	○	○	○	
25		K-L	○	○	○	○	○	○	○	○	○	○	○	○	○	○	○	○	○	○	○	○	○	
		S	○	○	○	○	○	○	○	○	○	○	○	○	○	○	○	○	○	○	○	○	○	○
40		L	○	● 36-80	● 17/16-31/8	○	● 7/8-2W	○	○	○	○	○	○	○	○	○	○	○	○	○	○	○	○	
		K	○	○	○	○	○	○	○	○	○	○	○	○	○	○	○	○	○	○	○	○	○	○
63		K-L	○	○	○	○	○	○	○	○	○	○	○	○	○	○	○	○	○	○	○	○	○	○
		S	○	○	○	○	○	○	○	○	○	○	○	○	○	○	○	○	○	○	○	○	○	○
159		L	○	○	○	○	○	○	○	○	○	○	○	○	○	○	○	○	○	○	○	○	○	○
		K	○	○	○	○	○	○	○	○	○	○	○	○	○	○	○	○	○	○	○	○	○	○



Hexagon  

## 6.3 (1/4") square drive

6.3 1/4 6.3 1/4

## Sets 6.3 (1/4") MM+INCH

6.3 1/4

# D 20 DMU-3 SOCKET SET 1/4"

14 pieces

- > With UD profile sockets and accessories made from GEDORE vanadium steel 31CrV3, hand-operated
- > With fine toothed, dial change ratchet
- > In plastic case
- > Dimensions 160 x 95 x 38 mm



6.3  
1/4  
mm

Ratchet	Sockets	Accessories		Code	No.
● U-3 <b>2093 U-3</b>	● D 20 4 4,5 5 5,5 6 7 8 9 10 11 12 13	<b>2090-4</b>	0.429	1815598	D 20 DMU-3

# INS 20 PM SCREWDRIVER BIT SOCKET SET 1/4"

15 pieces

- > With hand-operated screwdriver bit sockets in GEDORE vanadium special steel
- > In plastic case
- > Dimensions: 160 x 95 x 38 mm



6.3  
1/4

Sockets		Code	No.
● IN 20 3 4 5 6 8 ● IS 20 4 5,5 6,5 8 ● IKS 20 1 2 3 ● IKS 20 PZD 1 2 3	0.285	1815601	INS 20 PM

## ITX 20 TX-015

### SCREWDRIVER BIT SOCKET SET 1/4"

6.3

1/4"

15 pieces

- > With hand-operated screwdriver bit sockets in GEDORE vanadium special steel
- > In plastic case
- > Dimensions: 160 x 95 x 38 mm
- > TORX® = reg. trademark of Acument Intellectual Properties, LLC. USA



Sockets		Code	No.
<ul style="list-style-type: none"> <li>⊕ ITX 20 T8 T9 T10 T15</li> <li>T20 T25 T27 T30 T40</li> <li>⊙ TX 20 E4 E5 E6 E7 E8 E10</li> </ul>	0.307	1815628	ITX 20TX-015

## ITX 20 PM

### SCREWDRIVER BIT SOCKET SET 1/4"

6.3

1/4"

9 pieces

- > With hand-operated screwdriver bit sockets in GEDORE vanadium special steel
- > In plastic case
- > Dimensions: 110 x 65 x 31 mm
- > TORX® = reg. trademark of Acument Intellectual Properties, LLC. USA



Sockets		Code	No.
<ul style="list-style-type: none"> <li>⊕ ITX 20 T8 T9 T10 T15</li> <li>T20 T25 T27 T30 T40</li> </ul>	0.174	1815636	ITX 20 PM

# D 20 EMU-3 SOCKET SET 1/4"

17 pieces

- > With forged, tempered UD profile sockets, hand-operated
- > With accessories made from GEDORE vanadium steel 31CrV3
- > With fine toothed, dial change ratchet
- > In plastic case
- > Dimensions: 200 x 120 x 38 mm



Ratchet	Sockets	Accessories	kg	Code	No.
<b>2093 U-3</b>	<b>D 20</b> 4, 5, 5, 5, 6, 7, 8, 9, 10, 11, 13	<b>2087</b> <b>2090-4</b> <b>2095</b> <b>676 6,3</b>	0.625	1815652	D 20 EMU-3

# D 20 KMU-20 SOCKET SET 1/4"

37 pieces

- > With forged, tempered UD profile sockets, hand-operated
- > With accessories made from GEDORE vanadium steel 31CrV3
- > With robust lever-change reversible ratchet with push-button release
- > In plastic case
- > Dimensions: 200 x 120 x 38 mm
- > TORX® = reg. trademark of Acument Intellectual Properties, LLC. USA

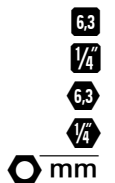

Ratchet	Sockets	Accessories	kg	Code	No.
<b>2093 U-20</b>	<b>D 20</b> 4, 5, 6, 7, 8, 9, 10, 11, 12, 13 <b>680</b> 4, 5, 5, 6, 5 <b>685</b> 3, 4, 5, 6 <b>685 X</b> 5, 6, 8 <b>687 TX</b> T10, T15, T20, T25, T27, T30, T40 <b>690</b> 1, 2 <b>690 PZD</b> 1, 2, 3	<b>2090-4</b> <b>620</b> <b>676</b> <b>699</b>	0.712	1822373	D 20 KMU-20

# D 20 KAU-20 SOCKET SET 1/4"

37 pieces

- > With forged, tempered UD profile sockets, hand-operated
- > With accessories made from GEDORE vanadium steel 31CrV3
- > With robust lever-change reversible ratchet with push-button release
- > In plastic case
- > Dimensions: 200 x 120 x 38 mm
- > TORX® = reg. trademark of Acument Intellectual Properties, LLC. USA



Ratchet	Sockets	Accessories	kg	Code	No.
U-20 <b>2093 U-20</b>	<b>D 20</b> 3/16 7/32 1/4 9/32 5/16 11/32 3/8 13/32 7/16 1/2" 680 4 5,5 6,5 685 1/8 5/32 3/16 1/4" 685 X 5 6 8 687 TX T10 T15 T20 T25 T27 T30 T40 690 1 2 690 PZD 1 2 3	2090-4 620 676 699	0.656	2010348	D 20 KAU-20

# D 20 TMU-10 SOCKET SET 1/4"

40 pieces

- > With forged, tempered UD profile sockets, hand-operated
- > With accessories made from GEDORE vanadium steel 31CrV3
- > With robust lever change reversible ratchet
- > In plastic case
- > Dimensions: 200 x 120 x 38 mm
- > TORX® = reg. trademark of Acument Intellectual Properties, LLC. USA



Ratchet	Sockets	Accessories	kg	Code	No.
U-10 <b>2093 U-10</b>	<b>D 20</b> 4 5 6 7 8 9 10 11 12 13 680 4 6,5 685 3 4 5 6 8 685 X 5 6 8 687 TX T10 T15 T20 T25 T27 T30 T40 690 1 2 690 PZD 1 2 3	620 639 673 6,3 676 699 2095 2090-4	0.767	1815660	D 20 TMU-10

# 20 XLU-3 T SOCKET SET 1/4"

37 pieces

- > With forged, tempered hexagon sockets, hand-operated, made from GEDORE vanadium steel 31CrV3
- > Screwdriver bits made from GEDORE vanadium special steel
- > With T-handle ratchet and telescopic extension no. 2099, adjustable from 186-296 mm
- > In plastic case
- > Dimensions: 200 x 120 x 38 mm
- > With "Check-Tool-System": 2-colour foam insert to check that the set is complete
- > TORX® = reg. trademark of Acument Intellectual Properties, LLC. USA

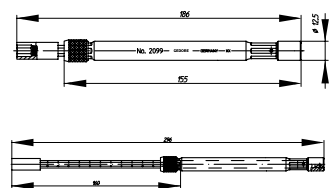

Ratchet	Sockets	Accessories	kg	Code	No.
<b>2093 U-3 T</b>	<ul style="list-style-type: none"> <li>○ 20 4 5 6 7 8 9 10 11 12 13</li> <li>⊖ 680 4 6,5</li> <li>● 685 3 4 5 6</li> <li>● 685 X 5 6 8</li> <li>⊕ 687 TX T8 T9 T10 T15 T20 T25 T27 T30 T40</li> <li>⊕ 690 1 2</li> <li>⊕ 690 PZD 1 2 3</li> </ul>	<ul style="list-style-type: none"> <li>673 6,3</li> <li>2099</li> <li> 2095</li> </ul>	0.800	1888447	20 XLU-3 T

# D 20 MOT BASIC TOOL SET 1/4" FOR MOTORBIKES

30 pieces

- > Packed with a basic assortment of tools for emergencies on motorbikes
- > In plastic case
- > Dimensions: 160 x 95 x 38 mm



Ratchet	Sockets	Accessories	kg	Code	No.
<ul style="list-style-type: none"> <li>● U-3 <b>2093 U-3 T</b></li> </ul>	<ul style="list-style-type: none"> <li>● D 20 8 9 10 11 12 13 14</li> <li>● 685 3 4 5 6 8 10</li> <li>⊕ 687 TX T10 T15 T20 T25 T27 T30 T40</li> <li>⊕ 690 1 2 3</li> <li>⊖ 680 4 6,5</li> </ul>	<ul style="list-style-type: none"> <li> 2090 KR-4</li> <li> 2090-6</li> <li> 2095</li> <li> 620</li> </ul>	0.572	2190281	D 20 MOT



# D 20 MOT-A

## BASIC TOOL SET 1/4" FOR MOTORBIKES

30 pieces

- > Packed with a basic assortment of tools for emergencies on motorbikes
- > In plastic case
- > Dimensions: 160 x 95 x 38 mm



Ratchet	Sockets	Accessories		Code	No.
U-3 <b>2093 U-3 T</b>	<b>D 20</b> 1/4 5/16 3/8 13/32 7/16 1/2 9/16" <b>685</b> 1/8 5/32 3/16 1/4 5/16 3/8" <b>687 TX</b> T10 T15 T20 T25 T27 T30 T40 <b>690</b> 1 2 3 <b>680</b> 4 6,5	<b>2090 KR-4</b> <b>2090-6</b> <b>2095</b> <b>620</b>	0.572	2193159	D 20 MOT-A

# 20 LMU-10

## SOCKET SET 1/4"

49 pieces

- > With forged, tempered long hexagon and short UD profile sockets, hand-operated
- > Accessories in GEDORE vanadium steel 31CrV3
- > With robust lever change reversible ratchet
- > In plastic case
- > Dimensions: 275 x 150 x 42 mm
- > With GEDORE Check-Tool-System: 2-colour foam insert to check that the set is complete
- > TORX® = reg. trademark of Acument Intellectual Properties, LLC. USA



Ratchet	Sockets	Accessories		Code	No.
U-10 <b>2093 U-10</b>	<b>D 20</b> 4 5 6 7 8 9 10 11 12 13 <b>20 L</b> 4 4,5 5 6 7 8 9 10 12 13 <b>680</b> 4 6,5 <b>685</b> 3 4 5 6 8 <b>685 X</b> 5 6 8 <b>687 TXT</b> T10 T15 T20 T25 T27 T30 T40 <b>690</b> 1 2 <b>690 PZD</b> 1 2 3	<b>620</b> <b>676</b> <b>699</b> <b>2090-2 -6</b> <b>2095</b>	1.262	1815687	20 LMU-10

# 20 EM

## SOCKET SET 1/4"

16 pieces

- > With forged, tempered hexagon sockets, hand-operated
- > With accessories made from GEDORE vanadium steel 31CrV3
- > Set U-10 with reversible lever change ratchet
- > Set U-3 with fine toothed, dial change ratchet
- > Set Z-94 with ratchet with square coupler
- > In plastic case
- > Dimensions: 200 x 120 x 38 mm

6,3  
1/4"  
mm



Ratchet	Sockets	Accessories	kg	Code	No.
<b>2093 Z-94</b>	<b>20</b> 4 4,5 5 5,5 6 7 8 9 10 11 13	<b>2087</b> <b>2090-4</b> <b>2095</b> <b>2098</b>	0.761	6172100	20 EMZ
<b>2093 U-3</b>	<b>20</b> 4 4,5 5 5,5 6 7 8 9 10 11 13	<b>2087</b> <b>2090-4</b> <b>2095</b> <b>2098</b>	0.776	6172290	20 EMU-3
<b>2093 U-10</b>	<b>20</b> 4 4,5 5 5,5 6 7 8 9 10 11 13	<b>2087</b> <b>2090-4</b> <b>2095</b> <b>2098</b>	0.790	6162220	20 EMU-10

# 20 EAU-3

## SOCKET SET 1/4"

14 pieces

- > With forged, tempered hexagon sockets, hand-operated
- > With accessories made from GEDORE vanadium steel 31CrV3
- > With extra fine toothed, dial change ratchet
- > In plastic case
- > Dimensions: 200 x 120 x 38 mm

6,3  
1/4"  
"AF



Ratchet	Sockets	Accessories	kg	Code	No.
<b>2093 U-3</b>	<b>20</b> 3/16 7/32 1/4 9/32 5/16 11/32 3/8 7/16 1/2"	<b>2087</b> <b>2090-4</b> <b>2095</b> <b>2098</b>	0.767	6172450	20 EAU-3

## 20 IMU-3 SOCKET SET 1/4"

32 pieces











- > With forged, tempered hexagon sockets, hand-operated
- > With accessories made from GEDORE vanadium steel 31CrV3
- > With fine toothed, dial change ratchet
- > In plastic case
- > Dimensions: 275 x 150 x 42 mm



6.3

1/4"

mm

Ratchet	Sockets	Accessories		Code	No.
 <b>2093 U-3</b>	 20 4 5 6 7 8 9 10 11 12 13 14  IS 20 4 5,5 6,5 8  IN 20 3 4 5 6 8  IKS 20 1 2 3  IKS 20 PZD 1 2 3	 <b>2087</b>  <b>2090-2 -6</b>  <b>2095</b>  <b>2098</b>	1.298	6174150	20 IMU-3

## 20 ITU-3 SOCKET SET 1/4"

36 pieces











- > With forged, tempered hexagon sockets, hand-operated
- > With accessories made from GEDORE vanadium steel 31CrV3
- > With fine toothed, dial change ratchet
- > In plastic case
- > Dimensions: 275 x 150 x 42 mm
- > TORX® = reg. trademark of Acument Intellectual Properties, LLC. USA



6.3

1/4"

mm

Ratchet	Sockets	Accessories		Code	No.
 <b>2093 U-3</b>	 20 4 5 6 7 8 9 10 11 12 13 14  IN 20 3 4 5 6 8  TX 20 E4 E5 E6 E7 E8 E10  ITX 20 T8 T9 T10 T15 T20 T25 T27 T30	 <b>2087</b>  <b>2090-2 -6</b>  <b>2095</b>  <b>2098</b>	1.376	6196710	20 ITU-3

## Ratchets 6.3 (1/4")

### 2093 U-20 REVERSIBLE RATCHET 1/4"

6.3  
1/4"

- > Used throughout industry and the automotive world - and as well in confined spaces
- > Acc. to DIN 3122, ISO 3315
- > Small, drop shaped head for confined areas
- > Fine-toothed, with lever change and push-button release
- > Return angle 9 degrees
- > Non-slip 2-component handle with hanging hole
- > For hand-operated sockets and accessories with square drive as per DIN 3120 - C 6.3, ISO 1174, ball locking device
- > GEDORE vanadium steel 31CrV3, chrome-plated

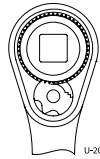

"	mm	°	mm	mm	kg	Code	No.
1/4	6.3	9	127	20	0.095	1703749	2093 U-20

### 2093 U-10 REVERSIBLE RATCHET 1/4"

6.3  
1/4"

- > Particularly for the demanding use experienced in industry and with utility vehicles
- > Acc. to DIN 3122, ISO 3315
- > With recessed lever change, locks in middle position
- > Return angle 15 degrees
- > Non-slip 2-component handle with hanging hole
- > For hand-operated sockets and accessories with square drive as per DIN 3120 - C 6.3, ISO 1174, ball locking device
- > GEDORE vanadium steel 31CrV3, chrome-plated



"	mm	°	mm	mm	kg	Code	No.
1/4	6.3	15	129	21.5	0.109	6180470	2093 U-10

### 2093 U-3 REVERSIBLE RATCHET 1/4"

- > Especially for working in confined spaces, as in the automotive business
- > Acc. to DIN 3122, ISO 3315
- > With non-slip metal disc change, fine-toothed (72 teeth) and robust
- > Return angle 5 degrees
- > Non-slip 2-component handle with hanging hole
- > For hand-operated sockets and accessories with square drive as per DIN 3120 - C 6.3, ISO 1174, ball locking device
- > GEDORE vanadium steel 31CrV3, chrome-plated

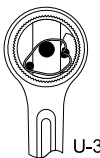

U-3



"	mm	°	mm	mm	kg	Code	No.
1/4	6.3	5	129	25	0.095	6170590	2093 U-3

### 2093 Z-94 RATCHET HANDLE WITH COUPLER 1/4"

- > Used throughout industry and the automotive world
- > Acc. to DIN 3122, ISO 3315
- > With square coupler, medium-fine toothed, extremely rugged
- > Return angle 18 degrees
- > For hand-operated sockets and accessories with square drive as per DIN 3120 - C 6.3, ISO 1174 ball locking device
- > GEDORE vanadium steel 31CrV3, chrome-plated

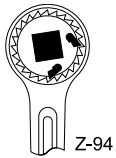

Z-94

"	mm	°	mm	mm	kg	Code	No.
1/4	6.3	18	129	12	0.076	6170750	2093 Z-94

### 2093 U-3 T RATCHET WITH T-HANDLE 1/4"

- > For progressing fast in confined spaces
- > Two-wing T-handle
- > Return angle 5 degrees
- > Ergonomic design for comfortable working
- > For hand-operated sockets and accessories with square drive as per DIN 3120 - C 6.3, ISO 1174, ball locking device
- > The danger of the tool canting, when carrying out work with extensions, is reduced by the central positioning of the square drive



"	mm	°	mm	kg	Code	No.
1/4	6.3	5	140	0.065	1791532	2093 U-3T

### 2093 HR-94 HAND RATCHET 1/4"

6.3  
1/4"

without handle

- > With square coupler
- > Return angle 18 degrees
- > Facilitates working quickly in confined spaces where other ratchets or tools do not fit
- > Especially suitable for servicing work in conjunction with extension 2090-12
- > Dimensions: Ø 26 x 20 mm



"	mm	°	kg	Code	No.
1/4	6.3	18	0.035	6069870	2093 HR-94

## Sockets 6.3 (1/4")

### 20 (MM) SOCKET 1/4"

hexagon

- > Acc. to DIN 3124, ISO 2725-1
- > Square drive as per DIN 3120 - C 6.3, ISO 1174, with ball retaining groove
- > Hand-operated, knurled grip
- > GEDORE vanadium steel 31CrV3, polished, chrome-plated

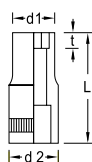

Ø mm	L	d <sub>1</sub>	d <sub>2</sub>	t		Code	No.
4.0	25	6.9	12.0	2.0	0.009	6165400	20 4
4.5	25	7.5	12.0	2.3	0.010	6165590	20 4,5
5.0	25	8.2	12.0	2.5	0.010	6165670	20 5
5.5	25	8.8	12.0	3.0	0.010	6165750	20 5,5
6.0	25	9.4	12.0	3.5	0.010	6165830	20 6
7.0	25	11.0	12.0	4.0	0.011	6165910	20 7
8.0	25	12.0	12.0	5.0	0.014	6166050	20 8
9.0	25	13.0	13.0	5.0	0.016	6166130	20 9
10.0	25	14.7	14.7	6.0	0.018	6166210	20 10
11.0	25	16.0	16.0	7.0	0.025	6166480	20 11
12.0	25	17.0	17.0	8.0	0.029	6166560	20 12
13.0	25	18.5	18.5	8.0	0.030	6166640	20 13
14.0	25	19.7	19.7	10.0	0.037	6166720	20 14

### 20 (AF) SOCKET 1/4"

hexagon

- > Square drive as per DIN 3120 - C 6.3, ISO 1174, with ball retaining groove
- > Hand-operated, knurled grip
- > GEDORE vanadium steel 31CrV3, polished, chrome-plated

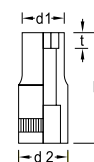

Ø AF	L	d <sub>1</sub>	d <sub>2</sub>	t		Code	No.
3/16	25	7.8	12.0	2.5	0.009	6167020	20 3/16AF
7/32	25	8.8	12.0	3.0	0.009	6167100	20 7/32AF
1/4	25	9.8	12.0	3.5	0.025	6167290	20 1/4AF
9/32	25	11.0	12.0	4.0	0.010	6167370	20 9/32AF
5/16	25	12.0	12.0	5.0	0.013	6167450	20 5/16AF
11/32	25	13.0	13.0	5.0	0.015	6167530	20 11/32AF
3/8	25	14.0	14.0	6.0	0.018	6167610	20 3/8AF
7/16	25	16.0	16.0	7.0	0.023	6167880	20 7/16AF
1/2	25	18.0	18.0	8.0	0.029	6167960	20 1/2AF
9/16	25	20.0	20.0	10.0	0.036	6161840	20 9/16AF

### 20 L (MM) SOCKET 1/4"

hexagon, long pattern

- > Acc. to DIN 3124, ISO 2725-1
- > Square drive as per DIN 3120 - C 6.3, ISO 1174, with ball retaining groove
- > Hand-operated, knurled grip
- > GEDORE vanadium steel 31CrV3, polished, chrome-plated

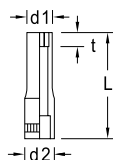

Ø mm	L	d <sub>1</sub>	d <sub>2</sub>	t		Code	No.
4.0	50	6.9	12.0	3.0	0.017	6191400	20 L 4
4.5	50	7.5	12.0	3.4	0.017	6191590	20 L 4,5
5.0	50	8.2	12.0	3.7	0.018	6191670	20 L 5
5.5	50	8.8	12.0	4.5	0.019	6191750	20 L 5,5
6.0	50	9.4	12.0	5.2	0.020	6191830	20 L 6
7.0	50	11.0	12.0	6.0	0.024	6191910	20 L 7
8.0	50	12.0	12.0	7.5	0.027	6192050	20 L 8
9.0	50	13.0	13.0	7.5	0.030	6192130	20 L 9
10.0	50	14.7	14.7	9.0	0.033	6192210	20 L 10
11.0	50	16.0	16.0	10.5	0.047	6192480	20 L 11
12.0	50	17.0	17.0	12.0	0.050	6192560	20 L 12
13.0	50	18.5	18.5	12.0	0.054	6192640	20 L 13

### 20 L (AF) SOCKET 1/4"

hexagon, long pattern

- > Square drive as per DIN 3120 - C 6.3, ISO 1174, with ball retaining groove
- > Hand-operated, knurled grip
- > GEDORE vanadium steel 31CrV3, polished, chrome-plated

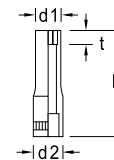

Ø AF	L	d <sub>1</sub>	d <sub>2</sub>	t		Code	No.
3/16	50	7.8	12.0	3.7	0.016	6192800	20 L 3/16AF
7/32	50	8.8	12.0	4.5	0.017	6192990	20 L 7/32AF
1/4	50	9.8	12.0	5.2	0.017	6193020	20 L 1/4AF
9/32	50	11.0	12.0	6.0	0.022	6193100	20 L 9/32AF
5/16	50	12.0	12.0	7.5	0.025	6193290	20 L 5/16AF
11/32	50	13.0	13.0	7.5	0.029	6193370	20 L 11/32AF
3/8	50	14.0	14.0	9.0	0.033	6193450	20 L 3/8AF
7/16	50	16.0	16.0	10.5	0.043	6193530	20 L 7/16AF
1/2	50	18.0	18.0	12.0	0.054	6193610	20 L 1/2AF

## D 20 (MM) SOCKET 1/4"

bi-hexagon UD profile

- > Acc. to DIN 3124, ISO 2725-1
- > Square drive as per DIN 3120 - C 6.3, ISO 1174, with ball retaining groove
- > Hand-operated, knurled grip
- > GEDORE vanadium steel 31CrV3, polished, chrome-plated

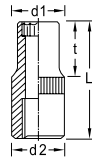

Ø mm	L	d <sub>1</sub>	d <sub>2</sub>	t		Code	No.
4.0	25	6.9	12.0	2.0	0.009	1649558	D 20 4
4.5	25	7.5	12.0	2.3	0.008	1649566	D 20 4,5
5.0	25	8.2	12.0	2.5	0.011	1649574	D 20 5
5.5	25	8.8	12.0	3.0	0.012	1802402	D 20 5,5
6.0	25	9.4	12.0	3.5	0.010	1649582	D 20 6
7.0	25	11.0	12.0	4.0	0.013	1649590	D 20 7
8.0	25	12.0	12.0	5.0	0.013	6225750	D 20 8
9.0	25	13.0	13.0	5.0	0.015	6225830	D 20 9
10.0	25	14.7	14.7	6.0	0.020	6226050	D 20 10
11.0	25	16.0	16.0	7.0	0.024	6226130	D 20 11
12.0	25	17.0	17.0	8.0	0.026	6226480	D 20 12
13.0	25	18.5	18.5	8.0	0.029	6226640	D 20 13
14.0	25	19.7	19.7	10.0	0.036	6226720	D 20 14

## D 20 (AF) SOCKET 1/4"

bi-hexagon UD profile

- > Square drive as per DIN 3120 - C 6.3, ISO 1174, with ball retaining groove
- > Hand-operated, knurled grip
- > GEDORE vanadium steel 31CrV3, polished, chrome-plated

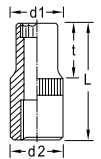
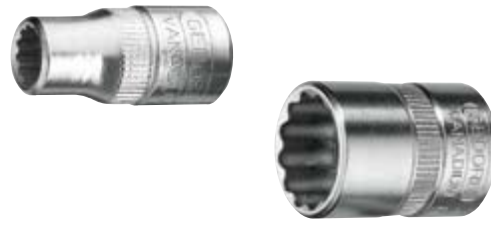

Ø"AF	L	d <sub>1</sub>	d <sub>2</sub>	t		Code	No.
3/16	25	7.8	12.0	2.5	0.010	1812505	D 20 3/16AF
7/32	25	8.8	12.0	3.0	0.011	1812513	D 20 7/32AF
1/4	25	9.8	12.0	3.5	0.011	1812521	D 20 1/4AF
9/32	25	11.0	12.0	4.0	0.012	1812548	D 20 9/32AF
5/16	25	12.0	12.0	5.0	0.012	6226800	D 20 5/16AF
11/32	25	13.0	13.0	5.0	0.015	6226990	D 20 11/32AF
3/8	25	14.0	14.0	6.0	0.017	6227020	D 20 3/8AF
13/32	25	15.0	15.0	6.0	0.020	1901702	D 20 13/32AF
7/16	25	16.0	16.0	7.0	0.022	6227370	D 20 7/16AF
1/2	25	18.0	18.0	8.0	0.028	6227450	D 20 1/2AF
9/16	25	20.0	20.0	10.0	0.034	6228180	D 20 9/16AF

## D 20 L SOCKET 1/4"

bi-hexagon UD profile, long pattern

- > Square drive as per DIN 3120 - C 6.3, ISO 1174, with ball retaining groove
- > Hand-operated, knurled grip
- > GEDORE vanadium steel 31CrV3, polished, chrome-plated



Ø"AF	L	d <sub>1</sub>	d <sub>2</sub>	t		Code	No.
3/16	50	7.8	12.0	3.7	0.017	1965433	D 20 L 3/16AF
7/32	50	8.8	12.0	4.5	0.019	1965476	D 20 L 7/32AF
1/4	50	9.8	12.0	5.2	0.017	1965417	D 20 L 1/4AF
9/32	50	11.0	12.0	6.0	0.043	1965484	D 20 L 9/32AF
5/16	50	12.0	12.0	7.5	0.024	1965441	D 20 L 5/16AF
11/32	50	13.0	13.0	7.5	0.043	1965492	D 20 L 11/32AF
3/8	50	14.0	14.0	9.0	0.035	1965425	D 20 L 3/8AF
7/16	50	16.0	16.0	10.5	0.043	1965468	D 20 L 7/16AF
1/2	50	18.0	18.0	12.0	0.054	1965409	D 20 L 1/2AF

## TX 20 SOCKET 1/4"

for protruding TORX® head screws

- > Square drive as per DIN 3120 - C 6.3, ISO 1174, with ball retaining groove
- > Hand-operated, knurled grip
- > GEDORE vanadium steel 31CrV3, polished, chrome-plated
- > TORX® = reg. trademark of Acument Intellectual Properties, LLC. USA

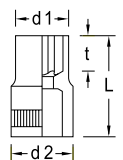

Ø			mm	L	d <sub>1</sub>	d <sub>2</sub>	t		Code	No.
E4	M3	3,86	25	5.5	12	4.5	0.008	6193880	TX 20 E4	
E5	M4	4,73	25	7.0	12	5.0	0.009	6187640	TX 20 E5	
E6	M5	5,74	25	8.0	12	5.0	0.010	6187720	TX 20 E6	
E7	M6	6,16	25	9.5	12	6.0	0.011	6187800	TX 20 E7	
E8	M6 - M7	7,52	25	10.5	12	6.5	0.014	6187990	TX 20 E8	
E10	M8	9,42	25	13.0	13	7.0	0.018	6193960	TX 20 E10	



# ITX 20

## SCREWDRIVER BIT SOCKET

### 1/4"

6.3  
1/4"

for recessed TORX® head screws

- > Square drive as per DIN 3120 - C 6.3, ISO 1174, with ball retaining groove
- > Hand-operated, knurled grip
- > Chrome-plated
- > With pressed-in pin in GEDORE vanadium special steel, gun-metal finish
- > TORX® = reg. trademark of Acument Intellectual Properties, LLC. USA

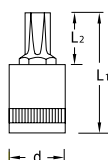

⊕	M	mm	L <sub>1</sub>	L <sub>2</sub>	d	kg	Code	No.
T8	M2,5	2,31	30.5	14.5	12	0.013	6190430	ITX 20 T8
T9	M3	2,50	30.5	14.5	12	0.013	6190510	ITX 20 T9
T10	M3 - M3,5	2,74	30.5	14.5	12	0.014	6190780	ITX 20 T10
T15	M3,5 - M4	3,27	30.5	14.5	12	0.014	6190860	ITX 20 T15
T20	M4 - M5	3,86	30.5	14.5	12	0.014	6190940	ITX 20 T20
T25	M4,5 - M5	4,43	30.5	14.5	12	0.014	6191080	ITX 20 T25
T27	M4,5 - M6	4,99	30.5	14.5	12	0.014	6191160	ITX 20 T27
T30	M6 - M7	5,52	30.5	14.5	12	0.015	6191240	ITX 20 T30
T40	M7 - M8	6,65	33.5	14.0	14	0.025	6265890	ITX 20 T40

# ITX 20 K

## SCREWDRIVER BIT SOCKET

### 1/4"

6.3  
1/4"

with ball end, for recessed TORX® head screws

- > Square drive as per DIN 3120 - C 6.3, ISO 1174, with ball retaining groove
- > Hand-operated, knurled grip
- > Chrome-plated
- > With pressed-in pin in GEDORE vanadium special steel, gun-metal finish
- > Swivel angle approx. 15-20°
- > Optimum transfer of power, also at places which are difficult of access
- > TORX® = reg. trademark of Acument Intellectual Properties, LLC. USA



ITX 20 K T10

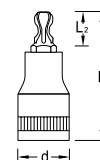

⊕	M	mm	L <sub>1</sub>	L <sub>2</sub>	d	kg	Code	No.
T10	M3 - M3,5	2,74	30.5	14.5	12	0.015	6120220	ITX 20 K T10
T15	M3,5 - M4	3,27	30.5	14.5	12	0.015	6120300	ITX 20 K T15
T20	M4 - M5	3,86	30.5	14.5	12	0.015	6120490	ITX 20 K T20
T25	M4,5 - M5	4,43	30.5	14.5	12	0.015	6120570	ITX 20 K T25
T27	M4,5 - M6	4,99	30.5	14.5	12	0.015	6120650	ITX 20 K T27
T30	M6 - M7	5,52	30.5	14.5	12	0.015	6120730	ITX 20 K T30
T40	M7 - M8	6,65	33.5	14.0	14	0.025	6120810	ITX 20 K T40

# IS 20

## SCREWDRIVER BIT SOCKET

### 1/4"

6.3  
1/4"

for slotted head screws

- > Square drive as per DIN 3120 - C 6.3, ISO 1174, with ball retaining groove
- > Hand-operated, knurled grip
- > Chrome-plated
- > Bit in GEDORE vanadium special steel, manganese-phosphated
- > Bit as per DIN ISO 2380-1 Form B

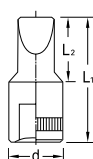

⊖ mm±C	mm±C	L <sub>1</sub>	L <sub>2</sub>	d	kg	Code	No.
4.0	0.8	28	14.5	12	0.011	6171560	IS 20 4x0,8
5.5	1.0	28	14.5	12	0.012	6171640	IS 20 5,5x1
6.5	1.2	28	14.5	12	0.012	6174230	IS 20 6,5x1,2
8.0	1.6	28	14.5	12	0.012	6174310	IS 20 8x1,6

# IKS 20

## SCREWDRIVER BIT SOCKET

### 1/4"

6.3  
1/4"

for cross-head screws PH

- > Square drive as per DIN 3120 - C 6.3, ISO 1174, with ball retaining groove
- > Hand-operated, knurled grip
- > Chrome-plated
- > Bit in GEDORE vanadium special steel, manganese-phosphated
- > Tip as per DIN ISO 8764-1 PH

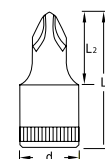

⊕ PH	L <sub>1</sub>	L <sub>2</sub>	d	kg	Code	No.
1	28	14.5	12	0.011	6174580	IKS 20 1
2	28	14.5	12	0.012	6174660	IKS 20 2
3	28	14.5	12	0.012	6174740	IKS 20 3
4	28	14.5	12	0.014	6174820	IKS 20 4

## IKS 20 PZD SCREWDRIVER BIT SOCKET 1/4"

6.3  
1/4"

for cross-head screws Pozi PZ

- > Square drive as per DIN 3120 - C 6.3, ISO 1174, with ball retaining groove
- > Hand-operated, knurled grip
- > Chrome-plated
- > Bit in GEDORE vanadium special steel, manganese-phosphated
- > Tip as per DIN ISO 8764-1 PZ

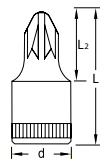

⊕ PZ	L <sub>1</sub>	L <sub>2</sub>	d	⚖	Code	No.
1	28	14.5	12	0.012	6187130	IKS 20 PZD 1
2	28	14.5	12	0.013	6187210	IKS 20 PZD 2
3	28	14.5	12	0.014	6187480	IKS 20 PZD 3
4	28	14.5	12	0.015	6187560	IKS 20 PZD 4

## IN 20 SCREWDRIVER BIT SOCKET 1/4"

6.3  
1/4"

for in-hex screws

- > Acc. to DIN 7422
- > Square drive as per DIN 3120 - C 6.3, ISO 1174, with ball retaining groove
- > Hand-operated, knurled grip
- > Chrome-plated
- > Bit in GEDORE vanadium special steel, manganese-phosphated
- \* not standardised

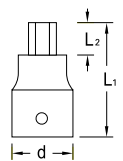

● mm	L <sub>1</sub>	L <sub>2</sub>	d	⚖	Code	No.
2	*	28	3.0	12	0.010	1812556 IN 20 2
2,5	*	28	3.5	12	0.010	1707736 IN 20 2,5
3		28	5.5	12	0.011	6176010 IN 20 3
4		28	7.0	12	0.011	6176280 IN 20 4
5		28	8.0	12	0.012	6176360 IN 20 5
6		28	8.5	12	0.013	6178490 IN 20 6
8	*	28	10.0	12	0.016	6178570 IN 20 8

## IN 20 L SCREWDRIVER BIT SOCKET 1/4"

6.3  
1/4"

for in-hex screws, long pattern

- > Acc. to DIN 7422
- > Square drive as per DIN 3120 - C 6.3, ISO 1174, with ball retaining groove
- > Hand-operated, knurled grip
- > Chrome-plated
- > Bit in GEDORE vanadium special steel, manganese-phosphated

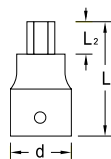

● mm	L <sub>1</sub>	L <sub>2</sub>	d	⚖	Code	No.
3	60	32	12	0.024	1933256	IN 20 L 3-60
4	60	32	12	0.025	1933264	IN 20 L 4-60
5	60	32	12	0.027	1933272	IN 20 L 5-60
6	60	32	12	0.029	1933280	IN 20 L 6-60
8	60	32	14	0.050	1933299	IN 20 L 8-60

## IN 20 K SCREWDRIVER BIT SOCKET 1/4"

6.3  
1/4"

with ball end, for in-hex screws

- > Square drive as per DIN 3120 - C 6.3, ISO 1174, with ball retaining groove
- > Hand-operated, knurled grip
- > Chrome-plated
- > With pressed-in pin, manganese-phosphated
- > Total swivel angle approx. 15-20°

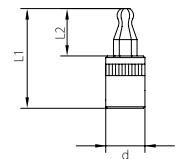

● mm	L <sub>1</sub>	L <sub>2</sub>	d	⚖	Code	No.
4	30.5	14.5	12	0.010	2219409	IN 20 K 4
5	30.5	14.5	12	0.010	2219417	IN 20 K 5
6	30.5	14.5	12	0.013	2219468	IN 20 K 6

## Accessories 6.3 (1/4")

### 2097 SWIVEL HANDLE 1/4"

- > Acc. to DIN 3122, ISO 3315
- > For hand-operated sockets with square drive as per DIN 3120, ISO 1174, with ball locking device
- > GEDORE vanadium steel 31CrV3, polished, chrome-plated, square drive manganese-phosphated



1/4"	6.3	146	0.094	Code	No.
1/4	6.3	146	0.094	6171050	2097

### 2098 T DRIVING HANDLE 1/4"

- > For hand-operated sockets with square drive as per DIN 3120, ISO 1174, with ball locking device
- > With bit adaptor no. 620 also suitable for 1/4" bits
- > Easy access to deep-fitting screws in confined areas
- > The danger of the tool canting, is reduced by the central positioning of the square drive
- > 2C-T-handle with hanging hole



1/4"	6.3	300	0.150	Code	No.
1/4	6.3	300	0.150	1939998	2098 T

### 2098 DRIVING HANDLE 1/4"

- > Acc. to DIN 3122, ISO 3315
- > For hand-operated sockets with square drive as per DIN 3120, ISO 1174, with ball locking device



1/4"	6.3	140	0.070	Code	No.
1/4	6.3	140	0.070	6171480	2098

### 2087 SLIDING T BAR 1/4"

- > Acc. to DIN 3122, ISO 3315
- > For hand-operated sockets with square drive as per DIN 3120, ISO 1174, with ball locking device
- > GEDORE vanadium steel 31CrV3, polished, chrome-plated



1/4"	6.3	115	0.039	Code	No.
1/4	6.3	115	0.039	6170160	2087

### 2090 EXTENSION 1/4"

- > Acc. to DIN 3123, ISO 3316
- > For hand-operated sockets with square drive as per DIN 3120, ISO 1174, with ball locking device
- > GEDORE vanadium steel 31CrV3, polished, chrome-plated
- \* not standardised



2090-2



2090-4



2090-6



2090-12

1/4"	6.3	55	0.025	Code	No.
1/4	6.3	55	0.025	6170320	2090-2
1/4	6.3	97	0.041	6170400	2090-4

1/4"	6.3	148	0.061	Code	No.
1/4	6.3	148	0.061	6171210	2090-6
1/4	6.3	*	0.124	6173340	2090-12

## 2088 FLEXIBLE EXTENSION 1/4"

- > For hand-operated sockets with square drive as per DIN 3120, ISO 1174, with ball locking device
- > GEDORE vanadium steel 31CrV3, polished, chrome-plated



□"	■	↳ mm ▷	⚖ kg	Code	No.
1/4	6.3	120	0.046	6170240	2088

## 2090 A EXTENSION 1/4"

with release

- > Easy access to deep-fitting screws in confined areas
- > No unintentional release of the socket from the extension due to safety ring
- > For hand-operated sockets with square drive as per DIN 3120, ISO 1174, ball locking device



□"	■	↳ mm ▷	⚖ kg	Code	No.
1/4	6.3	55	0.030	1932284	2090 A-2
1/4	6.3	97	0.050	1932292	2090 A-4
1/4	6.3	305	0.125	1932306	2090 A-12

## 2090 KR UNIVERSAL EXTENSION 1/4"

- > With ball end
- > For hand-operated sockets with square drive as per DIN 3120, ISO 1174, with ball locking device
- > The extension is able to pivot up to 15°
- > GEDORE vanadium steel 31CrV3, polished, chrome-plated



□"	■	↳ mm ▷	⚖ kg	Code	No.
1/4	6.3	55	0.024	1812564	2090 KR-2
1/4	6.3	97	0.045	1812572	2090 KR-4
1/4	6.3	148	0.060	6121030	2090 KR-6

## 2094 COUPLER 1/4"

- > Acc. to DIN 3122, ISO 3315
- > For hand-operated sockets with square drive as per DIN 3120, ISO 1174, with ball locking device
- > GEDORE vanadium steel 31CrV3, polished, chrome-plated



□"	■	↳ mm ▷	⚖ kg	Code	No.
1/4	6.3	19.8	0.006	6170830	2094

## 2099 TELESCOPIC EXTENSION 1/4"



magnetic

- > With 1/4" female square drive and 1/4" female hexagon drive
- > Automatic, form-fit connection
- > Adjustable in 10 mm steps from 192-296 mm
- > Suitable for 1/4" bits as well as with adaptor no. 673 for sockets up to 13 mm
- > Made of quality steel, manganese-phosphated resp. chrome-plated

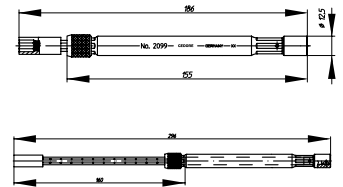

□"	□	○"	○	↳ mm ▷	⚖ kg	Code	No.
1/4	6.3	1/4	6.3	192-296	0.205	1888455	2099

## 2095 UNIVERSAL JOINT 1/4"

- > Acc. to DIN 3123, ISO 3316
- > For hand-operated sockets with square drive as per DIN 3120, ISO 1174, with ball locking device
- > GEDORE vanadium steel 31CrV3, polished, chrome-plated



□"	■	□"	□	↳ mm ▷	⚖ kg	Code	No.
1/4	6.3	1/4	6.3	38	0.026	6170910	2095

## 2030 CONVERTOR 1/4" TO 3/8"

- > Acc. to DIN 3123, ISO 3316
- > For hand-operated sockets with square drive as per DIN 3120, ISO 1174, with ball locking device
- > GEDORE vanadium steel 31CrV3, polished, chrome-plated



□"	□	■"	■	↳ mm ▷	⚖ kg	Code	No.
1/4	6.3	3/8	10	26	0.020	6170080	2030

# S 2032-05

## ADAPTOR SET 1/4" - 3/4"

5 pieces

- > Set of reducers and converters 1/4" - 3/4"
- > Reducers 1930, 3020
- > Convertors 2030, 3019, 1932
- > In transparent plastic box, dimensions: L 134 x W 51 x H 51 mm, foam insert light-blue
- > Please take note of the maximum capacity of the external squares of the reducers acc. to DIN 3123, ISO 3316

- 6.3
- 1/4"
- 10
- 3/8"
- 12.5
- 1/2"
- 20
- 3/4"



Contents		Code	No.
<b>Convertor 2030 1/4" - 3/8"</b>	0.340	1729071	S 2032-05
<b>Convertor 3019 3/8" - 1/2"</b>			
<b>Convertor 1932 1/2" - 3/4"</b>			
<b>Reducer 3020 3/8" - 1/4"</b>			
<b>Reducer 1930 1/2" - 3/8"</b>			

# SL 2013

## TOOL HOLDING RAIL, MAGNETIC 1/4"

empty

- > External squares to take 13 standard commercial 6.3 mm (1/4") sockets
- > Two female square adaptors to take ratchets, sliding T bars, extensions etc.
- > A strong magnet securely holds the socket rail to ferrous metals
- > Additional holes are provided for wall mounting the socket rail or attaching to non-ferrous materials
- > The sockets are securely locked by the ball at the square-drive end by turning them 90°
- > It is a simple matter to "unlock" and remove the sockets, by turning them 90° in the opposing direction
- > Delivery without tools

- 6.3
- 1/4"
- 6.3
- 1/4"
- 



↳ mm ↲	mm		Code	No.
380	33	0.355	1761080	SL 2013

10 (3/8") square drive

10 3/8 10 3/8

Sets 10 (3/8") METRIC

10 3/8

30 JMU / D 30 JMU  
SOCKET SET 3/8"

16 pieces

- > With forged, tempered hexagon (no. 30) or bi-hexagon (no. D 30) UD profile sockets, hand-operated
- > With accessories made from GEDORE vanadium steel 31CrV3
- > With reversible lever change ratchet
- > In GEDORE blue sheet steel case
- > Dimensions: 320 x 132 x 55 mm



10  
3/8  
mm

Ratchet	Sockets	Accessories	kg	Code	No.
U-10 3093 U-10	30 6 7 8 9 10 11 12 13 14 15 16 17 18 19	3090-5	2.2	2682885	30 JMU-10
U-10 3093 U-10	D 30 6 7 8 9 10 11 12 13 14 15 16 17 18 19	3090-5	2.3	2682893	D 30 JMU-10

30 HMU / D 30 HMU  
SOCKET SET 3/8"

22 pieces

- > With forged, tempered hexagon (no. 30) or bi-hexagon (no. D 30) UD profile sockets, hand-operated
- > With accessories made from GEDORE vanadium steel 31CrV3
- > Set U-3 with fine toothed, dial change ratchet
- > Set U-10 with reversible lever change ratchet
- > In GEDORE blue sheet steel case
- > Dimensions: 320 x 210 x 55 mm



10  
3/8  
mm

Ratchet	Sockets	Accessories	kg	Code	No.
U-3 3093 U-3	30 6 7 8 9 10 11 12 13 14 15 16 17 18 19 20 21 22	3087 3090-5 -10 3095	3.0	6238300	30 HMU-3
U-10 3093 U-10	30 6 7 8 9 10 11 12 13 14 15 16 17 18 19 20 21 22	3087 3090-5 -10 3095	3.0	6235470	30 HMU-10
U-3 3093 U-3	D 30 6 7 8 9 10 11 12 13 14 15 16 17 18 19 20 21 22	3087 3090-5 -10 3095	3.1	6240470	D 30 HMU-3
U-10 3093 U-10	D 30 6 7 8 9 10 11 12 13 14 15 16 17 18 19 20 21 22	3087 3090-5 -10 3095	3.1	6239700	D 30 HMU-10



# 30 GMU / D 30 GMU SOCKET SET 3/8"

17 pieces

- > With forged, tempered hexagon (no. 30) or bi-hexagon (no. D 30) UD profile sockets, hand-operated
- > With accessories made from GEDORE vanadium steel 31CrV3
- > Set U-3 with fine toothed, dial change ratchet
- > Set U-10 with reversible lever change ratchet
- > In GEDORE blue sheet steel case
- > Dimensions: 320 x 210 x 55 mm



10  
3/8  
mm

Ratchet	Sockets	Accessories	Weight	Code	No.
U-3 <b>3093 U-3</b>	30 6 7 8 9 10 11 13 14 15 16 17 19	3087 3090-5 -10 3095	2.6	6235980	30 GMU-3
U-10 <b>3093 U-10</b>	30 6 7 8 9 10 11 13 14 15 16 17 19	3087 3090-5 -10 3095	2.6	6235710	30 GMU-10
U-3 <b>3093 U-3</b>	D 30 6 7 8 9 10 11 13 14 15 16 17 19	3087 3090-5 -10 3095	2.7	6240200	D 30 GMU-3
U-10 <b>3093 U-10</b>	D 30 6 7 8 9 10 11 13 14 15 16 17 19	3087 3090-5 -10 3095	2.7	6239380	D 30 GMU-10

# 30 IMU SOCKET SET 3/8"

26 pieces

- > With forged, tempered hexagon UD profile sockets, hand-operated
- > With accessories made from GEDORE vanadium steel 31CrV3
- > Set U-3 with fine toothed, dial change ratchet
- > Set U-10 with reversible lever change ratchet
- > In GEDORE blue sheet steel case
- > Dimensions: 320 x 210 x 55 mm



10  
3/8  
mm

Ratchet	Sockets	Accessories	Weight	Code	No.
U-3 <b>3093 U-3</b>	30 6 7 8 9 10 11 12 13 14 15 16 17 19 IS 30 5,5 8 IN 30 4 5 6 8 IKS 30 2 3	3087 3090-5 -10 3095	3.1	6229900	30 IMU-3
U-10 <b>3093 U-10</b>	30 6 7 8 9 10 11 12 13 14 15 16 17 19 IS 30 5,5 8 IN 30 4 5 6 8 IKS 30 2 3	3087 3090-5 -10 3095	3.1	6229740	30 IMU-10

# D 30 KMU-20 SOCKET SET 3/8"

40 pieces

- > With forged, tempered bi-hexagon UD profile sockets, hand-operated
- > With accessories made from GEDORE vanadium steel 31CrV3
- > With robust lever-change reversible ratchet with push-button release
- > In GEDORE blue sheet steel case
- > Dimensions: 320 x 210 x 55 mm
- > TORX® = reg. trademark of Acument Intellectual Properties, LLC. USA

- 10
- 3/8"
- 6.3
- 1/4"
- mm



Ratchet	Sockets	Accessories		Code	No.
<b>3093 U-20</b> <b>3093 U-3 T</b>	<b>D 30</b> 8 9 10 11 12 13 14 15 16 17 18 19 <b>680</b> 4 5,5 6,5 <b>685</b> 3 4 5 6 <b>685 X</b> 5 6 8 <b>687 TX</b> T10 T15 T20 T25 T27 T30 <b>690</b> 1 2 <b>690 PZ</b> 1 2	<b>3090 KR-3</b> <b>3090-5</b> <b>630</b> <b>673</b> 10 <b>676</b> <b>699</b>	2.6	1973347	D 30 KMU-20

# D 30 TX20 U-20 SOCKET SET 3/8" + 1/4"

50 pieces

- > Tool set for general industrial and automotive applications
- > 3/8" and 1/4" sockets for protruding and recessed TORX® screws
- > With robust lever-change reversible ratchets, with push-button release
- > In sheet steel case with Check-Tool insert
- > Dimensions: 320 x 210 x 55 mm
- > TORX® = reg. trademark of Acument Intellectual Properties, LLC. USA

- 10
- 3/8"
- 6.3
- 1/4"
- 6.3
- 1/4"
- mm

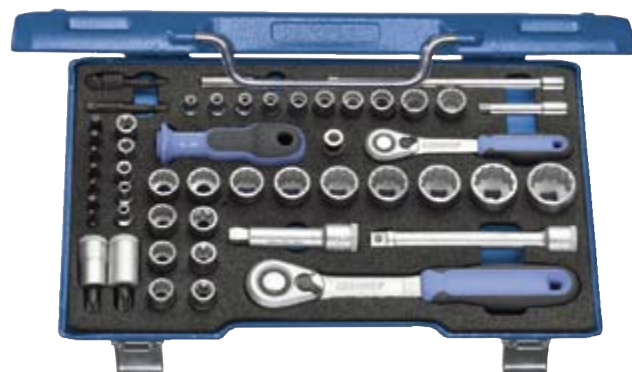

Ratchet	Sockets	Accessories		Code	No.
<b>3093 U-20</b> <b>2093 U-20</b>	<b>D 30</b> 10 11 12 13 14 15 16 17 18 19 21 22 <b>TX 30</b> E11 E12 E14 <b>ITX 30</b> T45 T50 <b>D 20</b> 4 5 5,5 6 7 8 9 10 12 13 <b>TX 20</b> E5 E6 E7 E8 E10 <b>687 TX</b> T10 T15 T20 T25 T27 T30 T40	<b>3090 KR-3</b> <b>3090-5</b> <b>2090 KR-2</b> <b>2090-6</b> <b>620</b> <b>673</b> 6,3 10 <b>676</b> <b>699</b>	3.2	2075695	D 30 TX20 U-20

## IN 30 LKM SCREWDRIVER BIT SOCKET SET 3/8"

10  
3/8  
mm

10 pieces

- > For in-hex screws, short and long
- > In plastic case
- > Dimensions: 200 x 120 x 38 mm



Sockets	kg	Code	No.
● IN 30 4 5 6 8 10	0.761	1509918	IN 30 LKM
● IN 30 L 4 5 6 8 10			

## ITX 30 PM SCREWDRIVER BIT SOCKET SET 3/8"

10  
3/8

7 pieces

- > For recessed TORX® screws
- > In plastic case
- > Dimensions: 200 x 120 x 38 mm
- > TORX® = reg. trademark of Acument Intellectual Properties, LLC. USA



Sockets	kg	Code	No.
● ITX 30 T20 T25 T27 T30 T40 T45 T50	0.627	1509926	ITX 30 PM

## ITX 30 LKP SCREWDRIVER BIT SOCKET SET 3/8"

10  
3/8

14 pieces

- > For recessed TORX® screws, short and long
- > In plastic case
- > Dimensions: 200 x 120 x 38 mm
- > TORX® = reg. trademark of Acument Intellectual Properties, LLC. USA



Sockets	kg	Code	No.
● ITX 30 T20 T25 T27 T30 T40 T45 T50	1.081	1509950	ITX 30 LKP
● ITX 30 L T20 T25 T27 T30 T40 T45 T50			

## ITX 30 TX-015 SCREWDRIVER BIT SOCKET SET 3/8"

10  
3/8

15 pieces

- > For protruding and recessed TORX® screws
- > In plastic case
- > Dimensions: 200 x 120 x 38 mm
- > TORX® = reg. trademark of Acument Intellectual Properties, LLC. USA



Sockets	kg	Code	No.
● ITX 30 T20 T25 T27 T30 T40 T45 T50	0.801	1509942	ITX 30 TX-015
● TX 30 E5 E6 E7 E8 E10 E11 E12 E14			

## TX 30 E-08 SOCKET SET 3/8"

10  
3/8

8 pieces

- > For protruding TORX® screws
- > In plastic case
- > Dimensions: 160 x 95 x 38 mm
- > TORX® = reg. trademark of Acument Intellectual Properties, LLC. USA



Sockets	kg	Code	No.
● TX 30 E5 E6 E7 E8 E10 E11 E12 E14	0.485	1509934	TX 30 E-08

## 30 TX 20 SCREWDRIVER BIT SOCKET SET 3/8" + 1/4"

6.3  
1/4  
10  
3/8

28 pieces

- > 3/8" and 1/4" sockets for protruding and recessed TORX® screws
- > In plastic case
- > Dimensions: 275 x 150 x 42 mm
- > TORX® = reg. trademark of Acument Intellectual Properties, LLC. USA



Sockets	kg	Code	No.
☒ ● ITX 30 T25 T27 T30 T40 T45 T50	1.484	1509969	30 TX 20
☒ ● ITX 30 L T20 T25 T27 T30 T40 T45 T50			
☒ ● TX 30 E8 E10 E11 E12 E14			
☒ ● ITX 20 T8 T9 T10 T15 T20			
☒ ● TX 20 E4 E5 E6 E7			
☒ ☒ 2030			

## Sets 10 (3/8") INCH





## D 30 JAU

### SOCKET SET 3/8"

12 pieces

- > With forged, tempered UD profile, hand-operated sockets
- > With accessories made from GEDORE vanadium steel 31CrV3
- > With reversible lever change ratchet
- > In GEDORE blue sheet steel case
- > Dimensions: 320 x 132 x 55 mm



Ratchet	Sockets	Accessories		Code	No.
 U-10 <b>3093 U-10</b>	 <b>D 30</b> 1/4 5/16 11/32 3/8 7/16 1/2 9/16 5/8 11/16 3/4"	 <b>3090-5</b>	2.0	2682907	D 30 JAU-10







## D 30 GAU

### SOCKET SET 3/8"

17 pieces

- > With forged, tempered UD profile, hand-operated sockets
- > With accessories made from GEDORE vanadium steel 31CrV3
- > With reversible lever change ratchet
- > In GEDORE blue sheet steel case
- > Dimensions: 320 x 210 x 55 mm



Ratchet	Sockets	Accessories		Code	No.
 U-10 <b>3093 U-10</b>	 <b>D 30</b> 1/4 9/32 5/16 11/32 3/8 7/16 1/2 9/16 19/32 5/8 11/16 3/4"	 <b>3087</b>  <b>3090-5 -10</b>  <b>3095</b>	2.6	6239540	D 30 GAU-10

## Ratchets 10 (3/8")

### 3093 U-20 REVERSIBLE RATCHET 3/8"

- > Used throughout industry and the automotive world - and as well in confined spaces
- > Acc. to DIN 3122, ISO 3315
- > Small, drop shaped head for confined areas
- > Fine-toothed (60 teeth), with lever change and push-button release
- > Return angle 6 degrees
- > Non-slip 2-component handle with hanging hole
- > For hand-operated sockets and accessories with square drive as per DIN 3120 - C 10, ISO 1174, ball locking device
- > GEDORE vanadium steel 31CrV3, chrome-plated

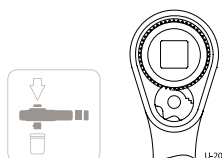

"	mm	°	mm	mm	kg	Code	No.
3/8	10	6	200	29.7	0.292	1556800	3093 U-20

### 3093 U-10 REVERSIBLE RATCHET 3/8"

- > Particularly for the demanding use experienced in industry and with utility vehicles
- > Acc. to DIN 3122, ISO 3315
- > With recessed lever change
- > Locks in the middle position: When the lever is flipped, it automatically engages for clockwise or counterclockwise operation
- > Push-button release
- > Return angle 11.25 degrees
- > Non-slip 2-component handle with hanging hole
- > For hand-operated sockets and accessories with square drive as per DIN 3120 - C 10, ISO 1174, ball locking device
- > GEDORE vanadium steel 31CrV3, chrome-plated

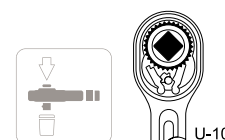

"	mm	°	mm	mm	kg	Code	No.
3/8	10	11,25	200	30.2	0.254	6236950	3093 U-10

### 3093 ALU-10 ALUMINIUM REVERSIBLE RATCHET 3/8"

- > Very lightweight, especially for work done above your head
- > Design spec. similar to DIN 3122, ISO 3315
- > Made from special-purpose drop-forged and hardened aluminium
- > The mechanism as in all U-10 ratchets is made from high quality steel
- > With recessed lever change
- > Locks in the middle position: When the lever is flipped, it automatically engages for clockwise or counterclockwise operation
- > Push-button release
- > Return angle 11.25 degrees
- > Non-slip 2-component handle with hanging hole
- > For hand-operated sockets and accessories with square drive as per DIN 3120 - C 10, ISO 1174, ball locking device
- > Extremely lightweight - just 160 g



"	mm	°	mm	mm	kg	Code	No.
3/8	10	11,25	200	30.2	0.160	1900005	3093 ALU-10

### 3093 U-3 REVERSIBLE RATCHET 3/8"

- > Especially for working in confined spaces, as in the automotive business
- > Acc. to DIN 3122, ISO 3315
- > With non-slip metal disc change, fine-toothed (72 teeth) and robust
- > Return angle 5 degrees
- > Non-slip 2-component handle with hanging hole
- > For hand-operated sockets and accessories with square drive as per DIN 3120 - C 10, ISO 1174, ball locking device
- > GEDORE vanadium steel 31CrV3, chrome-plated

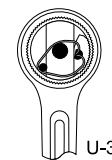

"	mm	°	mm	mm	kg	Code	No.
3/8	10	5	200	33.5	0.244	6237090	3093 U-3



## 3093 GU-3 SWIVEL HEAD REVERSIBLE RATCHET 3/8"

- > Especially for use in the automotive sector
- > Swivels through 180°, with joint lock
- > With non-slip metal disc change, fine-toothed (72 teeth) and robust
- > Return angle 5 degrees
- > Non-slip 2-component handle with hanging hole
- > Max. torque 200 N-m
- > For hand-operated sockets and accessories with square drive as per DIN 3120 - C 10, ISO 1174, ball locking device
- > GEDORE vanadium steel 31CrV3, chrome-plated



"	mm	°	mm	mm	kg	Code	No.
3/8	10	5	282	33.5	0.525	6237170	3093 GU-3

## 3093 Z-94 RATCHET HANDLE WITH COUPLER 3/8"

- > Used throughout industry and the automotive world
- > Acc. to DIN 3122, ISO 3315
- > With square coupler, medium-fine toothed, extremely rugged
- > Return angle 10 degrees
- > Non-slip 2-component handle with hanging hole
- > For hand-operated sockets and accessories with square drive as per DIN 3120 - C 10, ISO 1174, ball locking device
- > GEDORE vanadium steel 31CrV3, chrome-plated



"	mm	°	mm	mm	kg	Code	No.
3/8	10	10	200	18	0.223	6237680	3093 Z-94

VDE 3093 U

>573



## 3093 U-3 T RATCHET WITH T-HANDLE 3/8"

- > For progressing fast in confined spaces
- > Two-wing T-handle
- > Return angle 5 degrees
- > Ergonomic design for comfortable working
- > For hand-operated sockets and accessories with square drive as per DIN 3120 - C 10, ISO 1174, ball locking device
- > The danger of the tool canting, when carrying out work with extensions, is reduced by the central positioning of the square drive



"	mm	°	mm	kg	Code	No.
3/8	10	5	140	0.068	1973320	3093 U-3 T



## Sockets 10 (3/8")

### 30 (MM) SOCKET 3/8"

hexagon UD profile

- > Acc. to DIN 3124, ISO 2725-1
  - > Square drive as per DIN 3120 - C 10, ISO 1174, with ball retention groove
  - > Hand-operated, knurled grip
  - > GEDORE vanadium steel 31CrV3, polished, chrome-plated
- \* not standardised



### 10 3/8" 30 (AF) SOCKET 3/8"

hexagon UD profile

- > Square drive as per DIN 3120 - C 10, ISO 1174, with ball retention groove
- > Hand-operated, knurled grip
- > GEDORE vanadium steel 31CrV3, polished, chrome-plated

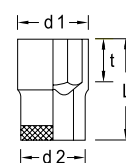
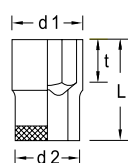

Ø mm	L	d <sub>1</sub>	d <sub>2</sub>	t		Code	No.
6	*	28	9.7	17.5	5.0	0.024	6230160 30 6
7		28	11.0	17.5	5.0	0.024	6230240 30 7
8		28	12.1	17.5	9.0	0.028	6230320 30 8
9		28	13.5	17.5	9.0	0.027	6230400 30 9
10		28	14.7	17.5	9.0	0.028	6230590 30 10
11		28	16.0	17.5	9.0	0.030	6233850 30 11
12		28	17.2	18.3	9.0	0.033	6233930 30 12
13		28	18.5	17.5	9.0	0.032	6234070 30 13
14		29	19.7	18.4	11.0	0.038	6234150 30 14
15		30	21.0	19.7	12.5	0.044	6234230 30 15
16		30	22.2	21.0	12.5	0.049	6234310 30 16
17		30	23.5	22.3	12.5	0.057	6234580 30 17
18		30	24.7	23.0	12.5	0.062	6234660 30 18
19		30	26.0	23.7	12.5	0.068	6234740 30 19
20		31	27.2	24.5	12.5	0.078	6234820 30 20
21		31	28.5	25.8	13.5	0.086	6234900 30 21
22		32	29.7	26.3	14.5	0.092	6235040 30 22
24	*	33	32.0	28.0	15.5	0.120	2194783 30 24

Ø AF	L	d <sub>1</sub>	d <sub>2</sub>	t		Code	No.
1/4	28	10.1	17.5	5.0	0.023	6232100	30 1/4AF
5/16	28	12.1	17.5	9.0	0.025	6232370	30 5/16AF
11/32	28	13.1	17.5	9.0	0.025	6232450	30 11/32AF
3/8	28	14.1	17.5	9.0	0.026	6232530	30 3/8AF
7/16	28	16.1	17.5	9.0	0.028	2101025	30 7/16AF
1/2	28	18.1	19.2	9.0	0.035	2101033	30 1/2AF
9/16	29	20.1	18.7	11.0	0.039	2101041	30 9/16AF
19/32	30	21.0	19.7	12.5	0.044	2101068	30 19/32AF
5/8	30	22.1	20.7	12.5	0.048	2101076	30 5/8AF
11/16	30	24.0	22.7	12.5	0.060	2101084	30 11/16AF
3/4	30	26.0	23.7	12.5	0.065	2101092	30 3/4AF
7/8	32	30.0	26.5	14.5	0.120	2101106	30 7/8AF



## D 30 (MM) SOCKET 3/8"



bi-hexagon UD profile

- > Acc. to DIN 3124, ISO 2725-1
  - > Square drive as per DIN 3120 - C 10, ISO 1174, with ball retention groove
  - > Hand-operated, knurled grip
  - > GEDORE vanadium steel 31CrV3, polished, chrome-plated
- \* not standardised

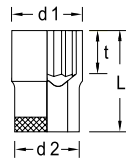

D 30 10

D 30 22

Ø mm	L	d <sub>1</sub>	d <sub>2</sub>	t		Code	No.
6	28	9.7	17.5	5.0	0.111	1845705	D 30 6
7	28	11.0	17.5	5.0	0.024	1845713	D 30 7
8	28	12.1	17.5	9.0	0.026	1845721	D 30 8
9	28	13.5	17.5	9.0	0.027	1845748	D 30 9
10	28	14.7	17.5	9.0	0.028	6229230	D 30 10
11	28	16.0	17.5	9.0	0.030	6230670	D 30 11
12	28	17.2	18.3	9.0	0.032	6230750	D 30 12
13	28	18.5	17.5	9.0	0.031	6230830	D 30 13
14	29	19.7	18.4	11.0	0.037	6230910	D 30 14
15	30	21.0	19.7	12.5	0.040	6231050	D 30 15
16	30	22.2	21.0	12.5	0.049	6231130	D 30 16
17	30	23.5	22.3	12.5	0.054	6231210	D 30 17
18	30	24.7	23.0	12.5	0.062	6231480	D 30 18
19	30	26.0	23.7	12.5	0.064	6231560	D 30 19
20	31	27.2	24.5	12.5	0.074	6231640	D 30 20
21	31	28.5	25.8	13.5	0.083	6231720	D 30 21
22	32	29.7	26.3	14.5	0.087	6231800	D 30 22
24	33	32.0	28.0	15.5	0.100	2194864	D 30 24

## D 30 (AF) SOCKET 3/8"



bi-hexagon UD profile

- > Square drive as per DIN 3120 - C 10, ISO 1174, with ball retention groove
- > Hand-operated, knurled grip
- > GEDORE vanadium steel 31CrV3, polished, chrome-plated

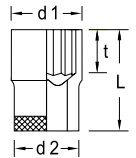

D 30 10

D 30 22

Ø "AF	L	d <sub>1</sub>	d <sub>2</sub>	t		Code	No.
1/4	28	10.1	17.5	5.0	0.050	2016613	D 30 1/4AF
9/32	28	11.1	17.5	5.0	0.020	2101009	D 30 9/32AF
5/16	28	12.1	17.5	5.0	0.020	1997122	D 30 5/16AF
11/32	28	13.1	17.5	9.0	0.026	2101017	D 30 11/32AF
3/8	28	14.1	17.5	9.0	0.010	1997130	D 30 3/8AF
13/32	28	15.0	17.5	9.0	0.030	1997149	D 30 13/32AF
7/16	28	16.1	17.5	9.0	0.027	6232610	D 30 7/16AF
1/2	28	18.1	19.2	9.0	0.034	6232880	D 30 1/2AF
9/16	29	20.1	18.7	11.0	0.036	6232960	D 30 9/16AF
19/32	30	21.0	19.7	12.5	0.039	6233180	D 30 19/32AF
5/8	30	22.1	20.7	12.5	0.044	6233260	D 30 5/8AF
11/16	30	24.0	22.7	12.5	0.053	6233340	D 30 11/16AF
3/4	30	26.0	23.7	12.5	0.061	6233420	D 30 3/4AF
25/32	31	27.0	24.3	12.5	0.075	1997157	D 30 25/32AF
13/16	31	28.0	25.3	12.5	0.080	1997165	D 30 13/16AF
7/8	32	30.0	26.5	14.5	0.082	6232020	D 30 7/8AF
15/16	33	31.9	28.0	15.5	0.110	1997173	D 30 15/16AF
1	33	33.9	30.0	15.5	0.120	1983296	D 30 1AF

## D 30 L (MM) SOCKET 3/8"



bi-hexagon UD profile, long pattern

- > Acc. to DIN 3124, ISO 2725-1
- > Square drive as per DIN 3120 - C 10, ISO 1174, with ball retaining groove
- > Hand-operated, knurled grip
- > GEDORE vanadium steel 31CrV3, polished, chrome-plated

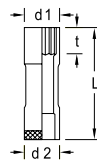

D 30 L 10

D 30 L 22

Ø mm	L	d <sub>1</sub>	d <sub>2</sub>	t		Code	No.
10	63.5	14.7	17.5	11	0.053	6258330	D 30 L 10
11	63.5	16.0	17.5	12	0.054	6258410	D 30 L 11
12	63.5	17.2	17.5	14	0.059	6258680	D 30 L 12
13	63.5	18.5	19.0	14	0.070	6258760	D 30 L 13
14	63.5	19.7	19.5	17	0.076	6258840	D 30 L 14
15	63.5	21.0	20.5	17	0.095	6258920	D 30 L 15
16	63.5	22.2	22.0	17	0.085	6259060	D 30 L 16
17	63.5	23.5	20.5	17	0.096	6259140	D 30 L 17
18	63.5	24.7	21.5	20	0.113	6259220	D 30 L 18
19	63.5	26.0	22.0	20	0.124	6259300	D 30 L 19
20	63.5	27.2	23.5	20	0.127	6259490	D 30 L 20
21	63.5	28.5	23.5	20	0.134	6259570	D 30 L 21
22	63.5	29.7	23.5	23	0.136	6259650	D 30 L 22

## D 30 L (AF) SOCKET 3/8"



bi-hexagon UD profile, long pattern

- > Square drive as per DIN 3120 - C 10, ISO 1174, with ball retaining groove
- > Hand-operated, knurled grip
- > GEDORE vanadium steel 31CrV3, polished, chrome-plated

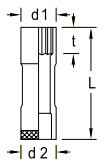

D 30 L 10

D 30 L 22

Ø "AF	L	d <sub>1</sub>	d <sub>2</sub>	t		Code	No.
3/8	63.5	14.1	17.5	11	0.051	6259730	D 30 L 3/8AF
7/16	63.5	16.1	17.5	12	0.053	6259810	D 30 L 7/16AF
1/2	63.5	18.1	19.0	14	0.065	6260070	D 30 L 1/2AF
9/16	63.5	20.1	19.5	17	0.073	6260150	D 30 L 9/16AF
5/8	63.5	22.1	22.0	17	0.092	6260230	D 30 L 5/8AF
11/16	63.5	24.0	20.5	17	0.090	6260310	D 30 L 11/16AF
3/4	63.5	26.0	22.0	20	0.109	6260580	D 30 L 3/4AF
13/16	63.5	28.3	23.5	20	0.132	6260660	D 30 L 13/16AF
7/8	63.5	30.0	23.5	23	0.134	6260740	D 30 L 7/8AF

# DG 30

## SWIVEL SOCKET 3/8"

bi-hexagon UD profile

- > Square drive as per DIN 3120 - C 10, ISO 1174, with ball retaining groove
- > Hand-operated
- > Chrome-vanadium steel 31CrV3, chrome-plated

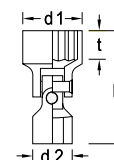

Ø mm	L	d <sub>1</sub>	d <sub>2</sub>	t		Code	No.
10	41.5	14.7	19	8.0	0.042	6240630	DG 30 10
13	42.5	18.5	19	9.0	0.050	6241520	DG 30 13
14	43.5	19.7	19	10.0	0.054	6241600	DG 30 14
15	45.5	21.0	19	11.0	0.048	6241790	DG 30 15
17	46.0	23.5	19	12.0	0.061	6241950	DG 30 17
18	46.0	24.7	19	12.5	0.063	6242410	DG 30 18
19	46.5	26.0	19	12.5	0.064	6242680	DG 30 19

# TX 30

## SOCKET 3/8"

for protruding TORX® head screws

- > Square drive as per DIN 3120 - C 10, ISO 1174, with ball retaining groove
- > Hand-operated, knurled grip
- > GEDORE vanadium steel 31CrV3, polished, chrome-plated
- > TORX® = reg. trademark of Acument Intellectual Properties, LLC. USA

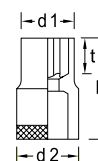

⊙	M	★ mm	L	d <sub>1</sub>	d <sub>2</sub>	t		Code	No.
E5	M4	4,73	28	7.2	17.5	5.0	0.025	6250270	TX 30 E5
E6	M5	5,74	28	8.5	17.5	5.0	0.025	6250350	TX 30 E6
E7	M6	6,16	28	9.5	17.5	5.5	0.025	6250430	TX 30 E7
E8	M6 - M7	7,52	28	10.8	17.5	6.0	0.027	6250510	TX 30 E8
E10	M8	9,42	28	13.2	17.5	9.0	0.029	6250780	TX 30 E10
E11	-	10,08	28	13.8	17.5	9.0	0.030	6250860	TX 30 E11
E12	M10	11,17	28	15.2	17.5	9.0	0.032	6250940	TX 30 E12
E14	M12	12,90	28	16.8	18.3	9.0	0.035	6251080	TX 30 E14

1500 ES-ITX 30

> 100

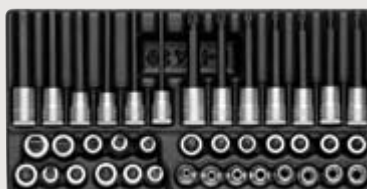

## ITX 30 SCREWDRIVER BIT SOCKET 3/8"

10  
3/8"

for recessed TORX® head screws

- > Square drive as per DIN 3120 - C 10, ISO 1174, with ball retaining groove
- > Hand-operated, knurled grip
- > Chrome-plated
- > With pressed-in pin in GEDORE vanadium special steel, gun-metal finish
- > TORX® = reg. trademark of Acument Intellectual Properties, LLC. USA

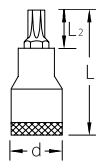

⊕	M	mm	L <sub>1</sub>	L <sub>2</sub>	d	kg	Code	No.
T20	M4 - M5	3,86	49	17	17.5	0.050	6246320	ITX 30 T20
T25	M4,5 - M5	4,43	49	17	17.5	0.051	6246830	ITX 30 T25
T27	M4,5 - M6	4,99	49	17	17.5	0.051	6247210	ITX 30 T27
T30	M6 - M7	5,52	49	17	17.5	0.051	6247560	ITX 30 T30
T40	M7 - M8	6,65	49	17	17.5	0.052	6247720	ITX 30 T40
T45	M8 - M10	7,82	49	17	17.5	0.053	6247800	ITX 30 T45
T50	M10	8,83	49	17	19.0	0.070	6247990	ITX 30 T50

## ITX 30 L SCREWDRIVER BIT SOCKET 3/8"

10  
3/8"

for recessed TORX® head screws, long pattern

- > Square drive as per DIN 3120 - C 10, ISO 1174, with ball retaining groove
- > Hand-operated, knurled grip
- > Chrome-plated
- > With pressed-in pin in GEDORE vanadium special steel, gun-metal finish
- > TORX® = reg. trademark of Acument Intellectual Properties, LLC. USA

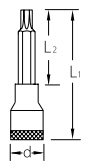

⊕	M	mm	L <sub>1</sub>	L <sub>2</sub>	d	kg	Code	No.
T20	M4 - M5	3,86	94	62	17.5	0.070	1394177	ITX 30 L T20
T25	M4,5 - M5	4,43	94	62	17.5	0.070	1394185	ITX 30 L T25
T27	M4,5 - M6	4,99	94	62	17.5	0.070	1394193	ITX 30 L T27
T30	M6 - M7	5,52	94	62	17.5	0.071	1394207	ITX 30 L T30
T40	M7 - M8	6,65	94	62	17.5	0.070	1394215	ITX 30 L T40
T45	M8 - M10	7,82	94	62	17.5	0.071	1394223	ITX 30 L T45
T50	M10	8,83	94	62	19.0	0.099	1394231	ITX 30 L T50

## ITX 30 B SCREWDRIVER BIT SOCKET 3/8"

10  
3/8"

for recessed TORX® head screws with pilot

- > Square drive as per DIN 3120 - C 10, ISO 1174, with ball retaining groove
- > Hand-operated, knurled grip
- > Chrome-plated
- > With pressed-in pin in GEDORE vanadium special steel, gun-metal finish
- > TORX® = reg. trademark of Acument Intellectual Properties, LLC. USA

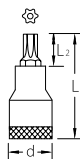

⊕	M	mm	L <sub>1</sub>	L <sub>2</sub>	d	Bore mm	kg	Code	No.
T20	M4 - M5	3,86	49	17	17.5	1,55 x 1,86	0.046	1440969	ITX 30 B T20
T25	M4,5 - M5	4,43	49	17	17.5	1,93 x 2,04	0.048	1440977	ITX 30 B T25
T27	M4,5 - M6	4,99	49	17	17.5	2,18 x 2,29	0.048	1440985	ITX 30 B T27
T30	M6 - M7	5,52	49	17	17.5	2,56 x 2,92	0.048	1440993	ITX 30 B T30
T40	M7 - M8	6,65	49	17	19.0	2,92 x 3,28	0.064	1429701	ITX 30 B T40
T45	M8 - M10	7,82	49	17	19.0	3,45 x 3,68	0.066	1441000	ITX 30 B T45
T50	M10	8,83	49	17	20.5	3,83 x 3,78	0.078	1441019	ITX 30 B T50

## IS 30 SCREWDRIVER BIT SOCKET 3/8"

10  
3/8"

for slotted head screws

- > Square drive as per DIN 3120 - C 10, ISO 1174, with ball retaining groove
- > Hand-operated, knurled grip
- > Chrome-plated
- > With pressed-in pin in GEDORE vanadium special steel, manganese-phosphated
- > Blade as per DIN ISO 2380-1, Form B

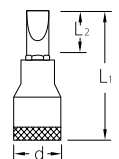

⊕	mm	mm	L <sub>1</sub>	L <sub>2</sub>	d	kg	Code	No.
5.5	1.0	55	27	17.5	0.040	6666100	IS 30 5,5x1	
6.5	1.2	55	27	17.5	0.039	1640895	IS 30 6,5x1,2	
8.0	1.2	55	23	17.5	0.054	6666290	IS 30 8x1,2	
10.0	1.6	55	23	19.0	0.072	6666370	IS 30 10x1,6	
12.0	2.0	55	23	20.5	0.083	1640909	IS 30 12x2	

## IKS 30 SCREWDRIVER BIT SOCKET 3/8"

10  
3/8"

for cross-head screws PH

- > Square drive as per DIN 3120 - C 10, ISO 1174, with ball retaining groove
- > Hand-operated, knurled grip
- > Chrome-plated
- > With pressed-in pin in GEDORE vanadium special steel, gun-metal finish
- > Tip as per DIN ISO 8764-1 PH

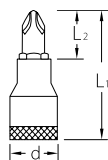

⊕ PH	L <sub>1</sub>	L <sub>2</sub>	d	⚖	Code	No.
1	55	27	17.5	0.041	6666610	IKS 30 1
2	55	23	17.5	0.052	6666880	IKS 30 2
3	55	23	19.0	0.070	6666960	IKS 30 3

## IKS 30 PZD SCREWDRIVER BIT SOCKET 3/8"

10  
3/8"

for cross-head screws Pozi PZ

- > Square drive as per DIN 3120 - C 10, ISO 1174, with ball retaining groove
- > Hand-operated, knurled grip
- > Chrome-plated
- > With pressed-in pin in GEDORE vanadium special steel, gun-metal finish
- > Tip as per DIN ISO 8764-1 PZ

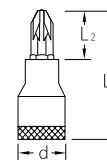

⊕ PZ	L <sub>1</sub>	L <sub>2</sub>	d	⚖	Code	No.
1	55	27	17.5	0.040	1640968	IKS 30 PZD 1
2	55	23	17.5	0.051	1640976	IKS 30 PZD 2
3	55	23	19.0	0.069	1640984	IKS 30 PZD 3

## IN 30 (MM) SCREWDRIVER BIT SOCKET 3/8"

10  
3/8"

for in-hex screws

- > Acc. to DIN 7422
  - > Square drive as per DIN 3120 - C 10, ISO 1174, with ball retaining groove
  - > Hand-operated, knurled grip
  - > Chrome-plated
  - > With pressed-in pin in GEDORE vanadium special steel, manganese-phosphated
- \* not standardised

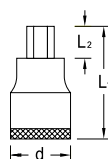

● mm	L <sub>1</sub>	L <sub>2</sub>	d	⚖	Code	No.
4	47	19	17.5	0.038	6241010	IN 30 4
5	47	19	17.5	0.039	6241280	IN 30 5
6	47	19	17.5	0.041	6241360	IN 30 6
7	*	47	17.5	0.041	1643037	IN 30 7
8	49	17	17.5	0.053	6241440	IN 30 8
10	49	17	19.0	0.073	6242920	IN 30 10

## IN 30 (AF) SCREWDRIVER BIT SOCKET 3/8"

10  
3/8"

for in-hex screws

- > Square drive as per DIN 3120 - C 10, ISO 1174, with ball retaining groove
- > Hand-operated, knurled grip
- > Chrome-plated
- > With pressed-in pin in GEDORE vanadium special steel, manganese-phosphated

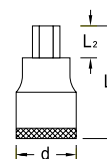

● AF	L <sub>1</sub>	L <sub>2</sub>	d	⚖	Code	No.
1/8	47	19	17.5	0.035	2195208	IN 30 1/8AF
5/32	47	19	17.5	0.040	2195232	IN 30 5/32AF
3/16	47	19	17.5	0.040	2195267	IN 30 3/16AF
1/4	47	19	17.5	0.049	1193422	IN 30 1/4AF
5/16	49	17	17.5	0.054	1193431	IN 30 5/16AF
3/8	49	17	19.0	0.050	1193449	IN 30 3/8AF

## IN 30 L SCREWDRIVER BIT SOCKET 3/8"

10  
3/8"

for in-hex screws, long pattern

- > Acc. to DIN 7422
- > Square drive as per DIN 3120 - C 10, ISO 1174, with ball retaining groove
- > Hand-operated, knurled grip
- > Chrome-plated
- > With pressed-in pin in GEDORE vanadium special steel, manganese-phosphated

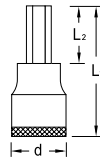

● mm	L <sub>1</sub>	L <sub>2</sub>	d	⚖	Code	No.
4	95	67	17.5	0.044	1510118	IN 30 L 4-95
5	95	67	17.5	0.048	1394347	IN 30 L 5-95
6	95	67	17.5	0.053	1394355	IN 30 L 6-95
7	95	67	17.5	0.058	1394363	IN 30 L 7-95
8	95	63	17.5	0.074	1394371	IN 30 L 8-95
10	95	63	19.0	0.105	1394398	IN 30 L 10-95

## IN 30 LK SCREWDRIVER BIT SOCKET 3/8"

10  
3/8"

with ball end, for in-hex screws, long pattern

- > Square drive as per DIN 3120 - C 10, ISO 1174, with ball retaining groove
- > Hand-operated, knurled grip
- > Chrome-plated
- > With pressed-in pin in GEDORE vanadium special steel, gun-metal finish
- > Total swivel angle approx. 15-20°

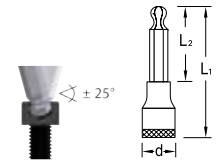

● mm	L <sub>1</sub>	L <sub>2</sub>	d	⚖	Code	No.
4	132	104	17.5	0.048	1505718	IN 30 LK 4
5	132	104	17.5	0.054	1505726	IN 30 LK 5
6	132	104	17.5	0.061	1505742	IN 30 LK 6
8	134	102	17.5	0.091	1505750	IN 30 LK 8
10	134	102	19.0	0.130	1505769	IN 30 LK 10

## INX 30 SCREWDRIVER BIT SOCKET 3/8"

10  
3/8"

for multi-point screws XZN

- > Acc. to DIN 2324
- > Square drive as per DIN 3120 - C 10, ISO 1174, with ball retaining groove
- > Hand-operated, knurled grip
- > Chrome-plated
- > With pressed-in pin in GEDORE vanadium special steel, manganese-phosphated
- > Tip as per DIN 2325

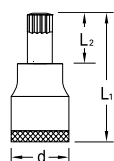
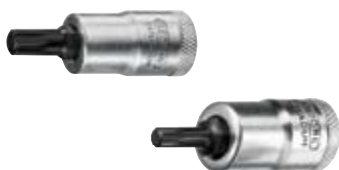

● mm	M	L <sub>1</sub>	L <sub>2</sub>	d	⚖	Code	No.
M5	49	17	17.5	0.050	6242170	INX 30 5	
M6	49	17	17.5	0.051	6242250	INX 30 6	
M8	49	17	17.5	0.053	6242330	INX 30 8	
M10	49	17	19.0	0.078	2194872	INX 30 10	

## INX 30 L SCREWDRIVER BIT SOCKET 3/8"

10  
3/8"

for multi-point screws XZN, long pattern

- > Acc. to DIN 2324
- > Square drive as per DIN 3120 - C 10, ISO 1174, with ball retaining groove
- > Hand-operated, knurled grip
- > Chrome-plated
- > With pressed-in pin in GEDORE vanadium special steel, manganese-phosphated
- > Tip as per DIN 2325

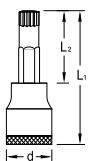

● mm	M	L <sub>1</sub>	L <sub>2</sub>	d	⚖	Code	No.
M6	94	62	17.5	0.068	1394312	INX 30 L 6	
M8	94	62	17.5	0.071	1394320	INX 30 L 8	
M10	94	62	19.0	0.079	1394339	INX 30 L 10	



## Accessories 10 (3/8")

### 3084 SPEED BRACE 3/8"

- > Acc. to DIN 3122, ISO 3315
- > For hand-operated sockets and accessories with square drive as per DIN 3120, ISO 1174, with ball locking device
- > GEDORE vanadium steel 31CrV3, polished, chrome-plated
- > No. 3084 L for applications e.g. in the aviation sector



"	■	↳ mm ↳	⚖ kg	Code	No.
3/8	10	288	0.423	6236440	3084
3/8	10	463	0.568	1965395	3084 L

### 3098 SWIVEL HANDLE 3/8"

- > For hand-operated sockets and accessories with square drive as per DIN 3120, ISO 1174, with ball locking device
- > GEDORE vanadium steel 31CrV3, polished, chrome-plated

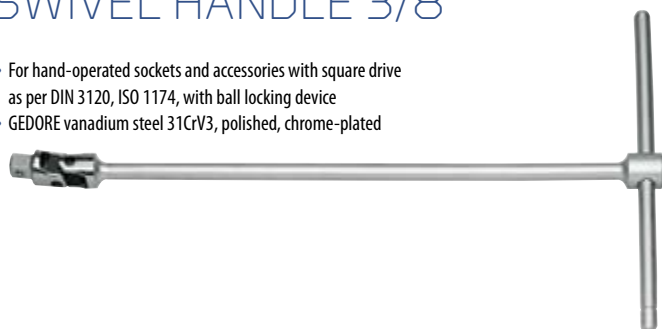

"	■	↳ mm ↳	⚖ kg	Code	No.
3/8	10	450	0.364	6182410	3098

### 3096 SWIVEL HANDLE 3/8"

- > Acc. to DIN 3122, ISO 3315
- > For hand-operated sockets and accessories with square drive as per DIN 3120, ISO 1174, with ball locking device
- > GEDORE vanadium steel 31CrV3, polished, chrome-plated



"	■	↳ mm ↳	⚖ kg	Code	No.
3/8	10	254	0.201	6238220	3096

### 3087 A SLIDING T BAR WITH RELEASE 3/8"

- > Secured against unintentional removal
- > GEDORE vanadium steel 31CrV3, polished, chrome-plated
- > Turn handle for easy locking and releasing
- > Accidental release when working is prevented because of the asymmetrical release point
- > Particularly useful for work in sensitive areas where certainty against loss is a theme
- > Examples: Aircraft engine, work in deep machine bodies
- > DBGm (German utility patent)



"	■	↳ mm ↳	⚖ kg	Code	No.
3/8	10	163	0.135	1871633	3087 A

### 3087 SLIDING T BAR 3/8"

- > Acc. to DIN 3122, ISO 3315
- > For hand-operated sockets and accessories with square drive as per DIN 3120, ISO 1174, with ball locking device
- > GEDORE vanadium steel 31CrV3, polished, chrome-plated



"	■	↳ mm ↳	⚖ kg	Code	No.
3/8	10	163	0.164	6236520	3087

## 3081 L-HANDLE 3/8"

- > Acc. to DIN 3122, ISO 3315
- > For hand-operated sockets and accessories with square drive as per DIN 3120, ISO 1174, with ball locking device
- > GEDORE vanadium steel 31CrV3, polished, chrome-plated



■ "	■	l- mm -l	⚖	Code	No.
3/8	10	180	0.153	6236360	3081

## 3090 A EXTENSION 3/8"

with release

- > Easy access to deep-fitting screws in confined areas
- > No unintentional release of the socket from the extension due to safety ring
- > For hand-operated sockets and accessories with square drive as per DIN 3120, ISO 1174, with ball locking device



■ "	■	l- mm -l	⚖	Code	No.
3/8	10	125	0.120	1932314	3090 A-5
3/8	10	250	0.210	1932322	3090 A-10

## 3090 M EXTENSION 3/8"

with magnet

- > For hand-operated sockets with square drive as per DIN 3120, ISO 1174, with ball locking device
- > The holding magnet securely fixes the screws or nuts in the socket
- > One-hand operation - using the socket the screw or nut can be immediately screwed in
- > Thanks to a spring mechanism the holding magnet is always in direct contact with the screw head. It ensures that the screw is centrally guided
- > A strong permanent magnet keeps hold of even large screws
- > Makes work easier particularly in confined spaces
- > Hot forged
- > GEDORE vanadium steel 31CrV3, polished



■ "	■	l- mm -l	⚖	Code	No.
3/8	10	65	0.065	2960060	3090 M

## 3090 EXTENSION 3/8"

- > Acc. to DIN 3123, ISO 3316
- > For hand-operated sockets and accessories with square drive as per DIN 3120, ISO 1174, with ball locking device
- > GEDORE vanadium steel 31CrV3, polished, chrome-plated
- \* not standardised

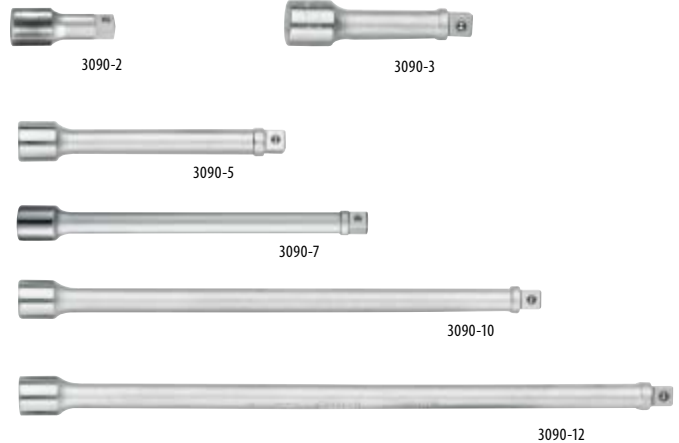

■ "	■		l- mm -l	⚖	Code	No.
3/8	10	*	50	0.063	1476637	3090-2
3/8	10		76	0.093	6236600	3090-3
3/8	10		125	0.117	6236790	3090-5
3/8	10	*	180	0.164	1476645	3090-7
3/8	10		250	0.222	6236870	3090-10
3/8	10	*	305	0.287	6238570	3090-12
3/8	10	*	500	0.524	1476653	3090-20

## 3090 KR UNIVERSAL EXTENSION 3/8"

- > With ball end
- > For hand-operated sockets with square drive as per DIN 3120, ISO 1174, with ball locking device
- > The extension is able to pivot up to 15°
- > GEDORE vanadium steel 31CrV3, polished, chrome-plated

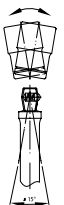

■ "	■	l- mm -l	⚖	Code	No.
3/8	10	76	0.080	1874381	3090 KR-3
3/8	10	125	0.108	1845756	3090 KR-5
3/8	10	250	0.197	1845764	3090 KR-10

VDE 3090

>573



## 3095 UNIVERSAL JOINT 3/8"

- > Acc. to DIN 3123, ISO 3316
- > For hand-operated sockets and accessories with square drive as per DIN 3120, ISO 1174, with ball locking device

- > GEDORE vanadium steel 31CrV3, polished, chrome-plated



"	"	"	"	mm	kg	Code	No.
3/8	10	3/8	10	50	0.053	6238140	3095

## 3094 COUPLER 3/8"

- > Acc. to DIN 3122, ISO 3316
- > For hand-operated sockets and accessories with square drive as per DIN 3120, ISO 1174, with ball locking device

- > GEDORE vanadium steel 31CrV3, polished, chrome-plated

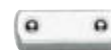

"	"	mm	kg	Code	No.
3/8	10	29	0.020	6237760	3094

## 3019 CONVERTOR 3/8" TO 1/2"

- > Acc. to DIN 3123, ISO 3316
- > For hand-operated sockets and accessories with square drive as per DIN 3120, ISO 1174, with ball locking device

- > GEDORE vanadium steel 31CrV3, polished, chrome-plated



"	"	"	"	mm	kg	Code	No.
3/8	10	1/2	12.5	35	0.053	6236010	3019

## 3020 REDUCER 3/8" TO 1/4"

- > Acc. to DIN 3123, ISO 3316
- > For hand-operated sockets and accessories with square drive as per DIN 3120, ISO 1174, with ball locking device

- > GEDORE vanadium steel 31CrV3, polished, chrome-plated



"	"	"	"	mm	kg	Code	No.
3/8	10	1/4	6.3	28	0.026	6236280	3020

## SL 3014 TOOL HOLDING RAIL, MAGNETIC 3/8"

empty

- > External squares to take 14 standard commercial 10 mm (3/8") sockets
- > Two female square adaptors to take ratchets, sliding T bars, extensions etc.
- > A strong magnet securely holds the socket rail to ferrous metals
- > Additional holes are provided for wall mounting the socket rail or attaching to non-ferrous materials
- > The sockets are securely locked by the ball at the square-drive end by turning them 90°

- > It is a simple matter to "unlock" and remove the sockets, by turning them 90° in the opposing direction
- > Delivery without tools



mm	mm	kg	Code	No.
380	33	0.355	1761080	SL 2013

## VH 30 SPRING STEEL SOCKET RAIL 3/8"

- > For 14 3/8" sockets
- > Delivery without tools



mm	kg	Code	No.
405	0.067	5164810	VH 30



12.5 (1/2") square drive

12.5 1/2"

Sets 12.5 (1/2") METRIC

12.5 1/2"

19 KMU / D 19 KMU  
SOCKET SET 1/2"

13 pieces

- > With forged, tempered hexagon (no.19) or UD profile sockets (no. D 19), hand-operated
- > With accessories made from GEDORE vanadium steel 31CrV
- > With robust lever-change reversible ratchet, with push-button release
- > In GEDORE blue sheet steel case
- > Dimensions: 320 x 132 x 55 mm



12.5  
1/2"  
mm

Ratchet	Sockets	Accessories	kg	Code	No.
U-20 <b>1993 U-20</b>	19 10 12 13 14 15 16 17 18 19 22 24	1990-5	2.9	2545810	19 KMU-20
U-20 <b>1993 U-20</b>	D 19 10 12 13 14 15 16 17 18 19 22 24	1990-5	2.9	2545829	D 19 KMU-20

19 JMU / D 19 JMU  
SOCKET SET 1/2"

19 pieces

- > With forged, tempered hexagon (no.19) or UD profile sockets (no. D 19), hand-operated
- > With accessories made from GEDORE vanadium steel 31CrV3
- > With fine toothed, dial change ratchet
- > In GEDORE blue sheet steel case
- > Dimensions: 320 x 210 x 55 mm



12.5  
1/2"  
mm

Ratchet	Sockets	Accessories	kg	Code	No.
U-3 <b>1993 U-3</b>	19 8 9 10 11 12 13 14 15 16 17 18 19 21 22 24	1990-5 -10 1995	3.7	2682842	19 JMU-3
U-3 <b>1993 U-3</b>	D 19 8 9 10 11 12 13 14 15 16 17 18 19 21 22 24	1990-5 -10 1995	3.7	2682850	D 19 JMU-3

# 19 EMU / D 19 EMU SOCKET SET 1/2"

23 pieces

- > With forged, tempered hexagon (no.19) or UD profile sockets (no. D 19), hand-operated
- > With accessories made from GEDORE vanadium steel 31CrV3
- > Set U-20 with robust lever-change reversible ratchet, with push-button release
- > Set U-3 with fine toothed, dial change ratchet
- > In GEDORE blue sheet steel case
- > Dimensions: 425 x 277 x 55 mm

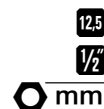

Ratchet	Sockets	Accessories	kg	Code	No.
U-20 <b>1993 U-20</b>	19 8 9 10 11 12 13 14 15 16 17 18 19 21 22 24 27 30 32	<b>1987</b> <b>1990-5 -10</b> <b>1995</b>	6.8	2545837	19 EMU-20
U-20 <b>1993 U-20</b>	D 19 8 9 10 11 12 13 14 15 16 17 18 19 21 22 24 27 30 32	<b>1987</b> <b>1990-5 -10</b> <b>1995</b>	6.7	2545845	D 19 EMU-20
U-3 <b>1993 U-3</b>	19 8 9 10 11 12 13 14 15 16 17 18 19 21 22 24 27 30 32	<b>1987</b> <b>1990-5 -10</b> <b>1995</b>	6.8	2545853	19 EMU-3
U-3 <b>1993 U-3</b>	D 19 8 9 10 11 12 13 14 15 16 17 18 19 21 22 24 27 30 32	<b>1987</b> <b>1990-5 -10</b> <b>1995</b>	6.6	2545861	D 19 EMU-3

# 19 TMU / D 19 TMU SOCKET SET 1/2"

25 pieces

- > With forged, tempered hexagon (no.19) or UD profile sockets (no. D 19), hand-operated
- > With accessories made from GEDORE vanadium steel 31CrV3
- > With reversible lever change ratchet, with push-button release
- > In GEDORE blue sheet steel case
- > Dimensions: 425 x 277 x 55 mm



Ratchet	Sockets	Accessories	kg	Code	No.
U-10 <b>1993 U-10 T</b>	19 10 11 12 13 14 15 16 17 18 19 21 22 23 24 26 27 28 30 32	<b>1985</b> <b>1987</b> <b>1990-5 -10</b> <b>1995</b>	7.8	6151880	19 TMU-10
U-10 <b>1993 U-10 T</b>	D 19 10 11 12 13 14 15 16 17 18 19 21 22 23 24 26 27 28 30 32	<b>1985</b> <b>1987</b> <b>1990-5 -10</b> <b>1995</b>	7.7	6151960	D 19 TMU-10











# 19 VMU / D 19 VMU SOCKET SET 1/2"

28 pieces

- > With forged, tempered hexagon (no.19) or UD profile sockets (no. D 19), hand-operated
- > With accessories made from GEDORE vanadium steel 31CrV3
- > With reversible lever change ratchet, with push-button release
- > In GEDORE blue sheet steel case
- > Dimensions: 425 x 277 x 55 mm

12.5  
1/2"  
mm



Ratchet	Sockets	Accessories		Code	No.
 <b>1993 U-10 T</b>	 <b>19</b> 10 11 12 13 14 15 16 17 18 19 20 21 22 23 24 26 27 28 30 32 33 34 36	 <b>1987</b>  <b>1990-5 -10</b>  <b>1995</b>	7.8	2682869	19 VMU-10
 <b>1993 U-10 T</b>	 <b>D 19</b> 10 11 12 13 14 15 16 17 18 19 20 21 22 23 24 26 27 28 30 32 33 34 36	 <b>1987</b>  <b>1990-5 -10</b>  <b>1995</b>	7.8	2682877	D 19 VMU-10







# 19 LMU-10 SOCKET SET 1/2"

31 pieces

- > With forged, tempered UD profile sockets, hand-operated
- > Impact sockets with protective sleeve
- > With accessories made from GEDORE vanadium steel 31CrV3
- > With reversible lever change ratchet, with push-button release
- > In GEDORE blue sheet steel case
- > Dimensions: 425 x 277 x 55 mm

12.5  
1/2"  
mm



Ratchet	Sockets	Accessories		Code	No.
 <b>1993 U-10 T</b>	 <b>19</b> 10 11 12 13 14 15 16 17 18 19 21 22 24 27 32 36  <b>D 19 L</b> 10 12 13 14 15 16 18 24  <b>K 19 LS</b> 17 19 21 22	 <b>1990-5 -10</b>	8.3	1806033	19 LMU-10



# 19 RMU-10 SOCKET SET 1/2"

32 pieces

- > With forged, tempered hexagon UD profile sockets, hand-operated
- > With combination ratchet spanner no. 7 R for ratchet loosening and fast tightening
- > With accessories made from GEDORE vanadium steel 31CrV3
- > With reversible lever change ratchet, with push-button release
- > In GEDORE blue sheet steel case
- > Dimensions: 425 x 277 x 55 mm

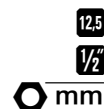

Ratchet	Sockets	Accessories		Code	No.
U-10 <b>1993 U-10 T</b>	<b>19</b> 8 10 11 12 13 14 15 16 17 18 19 21 22 24 27 32 36 <b>7 R</b> 8 10 11 12 13 14 15 16 17 18 19	<b>1990-5 -10</b> <b>1995</b>	7.7	6145210	19 RMU-10

# IN 19 Q SCREWDRIVER BIT SOCKET SET 1/2"

11 pieces

- > For in-hex screws
- > In GEDORE blue sheet steel case
- > Dimensions: 320 x 210 x 55 mm

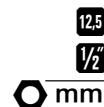

Ratchet	Sockets	Accessories		Code	No.
U-10 <b>1993 U-10 T</b>	<b>IN 19</b> 5 6 7 8 9 10 12 14 17	<b>1990-10</b>	3.3	6156920	IN 19 Q

# 19 IMU / D 19 IMU SOCKET SET 1/2"

27 pieces

- > With forged, tempered hexagon (no.19) or UD profile sockets (no. D 19), hand-operated
- > With accessories made from GEDORE vanadium steel 31CrV3
- > With reversible lever change ratchet, with push-button release
- > In GEDORE blue sheet steel case
- > Dimensions: 425 x 277 x 55 mm

12.5  
1/2"  
mm



Ratchet	Sockets	Accessories	kg	Code	No.
U-10 1993 U-10 T	19 10 11 12 13 14 15 17 19 22 24 27 30 IN 19 5 6 7 8 10 12 14 IS 19 8 10 IKS 19 2 3	1990-5 -10 1995	6.9	6139750	19 IMU-10
U-10 1993 U-10 T	D 19 10 11 12 13 14 15 17 19 22 24 27 30 IN 19 5 6 7 8 10 12 14 IS 19 8 10 IKS 19 2 3	1990-5 -10 1995	6.8	6140090	D 19 IMU-10

# ITX 19 TXU-20 SOCKET SET 1/2"

25 pieces

- > For protruding and recessed TORX® screws
- > In GEDORE blue sheet steel case
- > Dimensions: 425 x 277 x 55 mm
- > TORX® = reg. trademark of Acument Intellectual Properties, LLC. USA

12.5  
1/2"  
12.5  
1/2"







Ratchet	Sockets	Accessories	kg	Code	No.
U-20 1993 U-20	ITX 19 T20 T25 T27 T30 T40 T45 T50 T55 T60 TX 19 E10 E11 E12 E14 E16 E18 E20 E24 TX 4 E6xE8 E10xE12 E14xE18 E20xE24	1990-5 -10 1995	6.4	2546019	ITX 19 TXU-20

# ITX 19 INU-20 SOCKET SET 1/2"

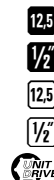
42 pieces

- > For protruding and recessed TORX® screws and in-hex screws
- > In GEDORE blue sheet steel case
- > Dimensions: 425 x 277 x 55 mm
- > TORX® = reg. trademark of Acument Intellectual Properties, LLC. USA











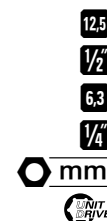









Ratchet	Sockets	Accessories		Code	No.
 <b>1993 U-20</b>	<ul style="list-style-type: none"> <li>○ <b>19</b> 10 11 12 13 14 15 16 17 18 19 21 22 24 27 30 32</li> <li>● <b>IN 19</b> 5 6 7 8 9 10 12 14 17</li> <li>⊕ <b>TX 19</b> E10 E12 E14 E16 E18 E20 E24</li> <li>⊕ <b>ITX 19</b> T20 T25 T27 T30 T40 T45 T50 T55 T60</li> </ul>	 <b>1990 KR-10</b>	8.2	2546000	ITX 19 INU-20

# 19 V20U-10 SOCKET SET 1/4"-1/2"

50 pieces

- > With forged, tempered hexagon or UD profile sockets, hand-operated
- > With accessories made from GEDORE vanadium steel 31CrV3
- > 1/4" with fine toothed, dial change ratchet U-3
- > 1/2" with reversible lever change ratchet U-10 T
- > In GEDORE blue sheet steel case
- > Dimensions: 425 x 277 x 55 mm



Ratchet	Sockets	Accessories		Code	No.
 <b>1993 U-10 T</b>	<ul style="list-style-type: none"> <li> ○ <b>19</b> 10 11 12 13 14 15 17 19 22 24 27 30</li> <li> ● <b>IN 19</b> 7 8 10 12 14</li> <li> ⊖ <b>IS 19</b> 8 10</li> <li> ⊕ <b>IKS 19</b> 3</li> </ul>	<ul style="list-style-type: none"> <li> <b>1990-5 -10</b></li> <li> <b>1995</b></li> <li> <b>2098</b></li> <li> <b>2090-2 -4</b></li> <li> <b>2087</b></li> <li> <b>2095</b></li> </ul>	7.2	6157490	19V20U-10
 <b>2093 U-3</b>	<ul style="list-style-type: none"> <li> ○ <b>20</b> 4 4,5 5 5,5 6 7 8 9 10 11 13</li> <li> ● <b>IN 20</b> 3 4 5 6</li> <li> ⊖ <b>IS 20</b> 4 5,5 6,5</li> <li> ⊕ <b>IKS 20</b> 1 2</li> </ul>				

# 19 V20U-20

## SOCKET SET 1/4"-1/2"

81 pieces

- > With forged, tempered sockets, hand-operated
- > With accessories made from GEDORE vanadium steel 31CrV3
- > With robust lever-change reversible ratchet, with push-button release
- > In GEDORE blue sheet steel case
- > Dimensions: 425 x 277 x 55 mm

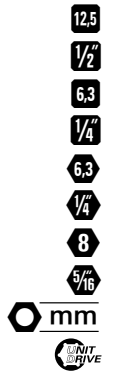

Ratchet	Sockets	Accessories	kg	Code	No.
1/2" U-20 <b>1993 U-20</b>	19 10 11 12 13 14 15 16 17 18 19 21 22 24 27 30 32 36	1990 KR-5 -10	7.4	1550691	19V20U-20
1/4" U-20 <b>2093 U-20</b>	D 20 4 5 5,5 6 7 8 9 10 11 12 13 680 4 4,5 5,5 6,5 685 2 2,5 3 4 5 6 8 685 X 5 6 8 687 TX T10 T15 T20 T25 T27 T30 T40 690 1 2 3 690 PZD 1 2 3 885 3 4 5 6 8 10 885 X 5 6 8 10 12 887 TX T27 T30 T40 T45 T50	2090-4 2095 620 676 699 KB 819			

# D 19 L-015

## SOCKET SET 1/2"

15 pieces

- > With forged, tempered UD profile sockets, hand-operated
- > In GEDORE blue sheet steel case
- > Dimensions: 320 x 210 x 55 mm

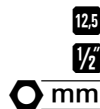

# IN 19 PM

## SCREWDRIVER BIT SOCKET SET 1/2"

9 pieces

- > For in-hex screws
- > In GEDORE blue sheet steel case
- > Dimensions: 281 x 79 x 35 mm



Sockets	kg	Code	No.
D 19 L 10 12 13 14 15 16 17 18 19 21 22 24 27 30 32	4.3	2190214	D 19 L-015

Sockets	kg	Code	No.
IN 19 S 6 7 8 9 10 12 14 17	1.362	6156250	IN 19 PM

## INX 19 PM SCREWDRIVER BIT SOCKET SET 1/2"

9 pieces

- > For slotted, cross-head and multi-point screws
- > In GEDORE blue sheet steel case
- > Dimensions: 281 x 79 x 35 mm



Sockets		Code	No.
● INX 19 5 6 8 10 12	1.3	6150050	INX 19 PM
⊕ IKS 19 2 3			
⊖ IS 19 12 16			

## IN 19 LKM SCREWDRIVER BIT SOCKET SET 1/2"

15 pieces

- > For in-hex screws, short and long
- > In GEDORE blue sheet steel case
- > Dimensions: 320 x 210 x 55 mm



Sockets		Code	No.
● IN 19 5 6 7 8 9 10 12 14 17	3.2	6129360	IN 19 LKM
● IN 19 L 5-90 6-90 8-90 10-140 12-140 14-140			

## ITX 19 PM / ITX 19 B-PM SCREWDRIVER BIT SOCKET SET 1/2"

9 pieces

- > ITX 19 PM: for recessed TORX® head screws
- > ITX 19 B-PM: for recessed TORX® head screws with pilot
- > In GEDORE blue sheet steel case
- > Dimensions: 281 x 79 x 35 mm
- > TORX® = reg. trademark of Acument Intellectual Properties, LLC. USA



Sockets		Code	No.
● ITX 19 T20 T25 T27 T30 T40 T45 T50 T55 T60	1.2	6158970	ITX 19 PM
● ITX 19 B T20 T25 T27 T30 T40 T45 T50 T55 T60	1.3	1394894	ITX 19 B-PM

## TX 19 E-09 SOCKET SET 1/2"

9 pieces

- > For protruding TORX® screws
- > With convertor 3/8" to 1/2"
- > In plastic case
- > Dimensions: 200 x 120 x 38 mm
- > TORX® = reg. trademark of Acument Intellectual Properties, LLC. USA



Sockets		Code	No.
● TX 19 E10 E11 E12 E14 E16 E18 E20 E24	1.0	6265970	TX 19 E-09
Ⓢ 3019			

## ITX 19 TX-017 SCREWDRIVER BIT SOCKET SET 1/2"

17 pieces

- > For protruding and recessed TORX® screws
- > In GEDORE blue sheet steel case
- > Dimensions: 320 x 210 x 55 mm
- > TORX® = reg. trademark of Acument Intellectual Properties, LLC. USA



12.5  
1/2"

## ITX 19 LKP SCREWDRIVER BIT SOCKET SET 1/2"

18 pieces

- > For recessed TORX® screws, short and long
- > In GEDORE blue sheet steel case
- > Dimensions: 320 x 210 x 55 mm
- > TORX® = reg. trademark of Acument Intellectual Properties, LLC. USA



12.5  
1/2"

Sockets		Code	No.
ITX 19 T20 T25 T27 T30 T40 T45 T50 T55 T60	2.8	6129520	ITX 19 TX-017
TX 19 E10 E11 E12 E14 E16 E18 E20 E24			

Sockets		Code	No.
ITX 19 T20 T25 T27 T30 T40 T45 T50 T55 T60	3.2	6138510	ITX 19 LKP
ITX 19 L T20 T25 T27 T30 T40 T45 T50 T55 T60			

## 19 TX 20 SCREWDRIVER BIT SOCKET SET 1/2" + 1/4"

34 pieces

- > 1/4" and 1/2" sockets for protruding and recessed TORX® screws
- > In GEDORE blue sheet steel case
- > Dimensions: 320 x 210 x 55 mm
- > TORX® = reg. trademark of Acument Intellectual Properties, LLC. USA



6.3  
1/4"  
12.5  
1/2"

Sockets		Code	No.
ITX 19 T40 T45 T50 T55 T60	3.6	6129440	19TX 20
ITX 19 LT20 T25 T27 T30 T40 T45 T50 T55 T60			
TX 19 E12 E14 E16 E18 E20 E24			
ITX 20 T8 T9 T10 T15 T20 T25 T27 T30			
TX 20 E4 E5 E6 E7 E8 E10			



## Sets 12.5 (1/2") INCH

D 19 WAU-20  
SOCKET SET 1/2"

31 pieces





- > With forged, tempered UD profile sockets, hand-operated
- > With accessories made from GEDORE vanadium steel 31CrV3
- > With robust lever-change reversible ratchet, with push-button release
- > In GEDORE blue sheet steel case
- > Dimensions: 425 x 277 x 55 mm



12.5

1/2"

"AF"

Ratchet	Sockets	Accessories		Code	No.
 <b>1993 U-20</b>	 <b>D 19</b> 5/16 11/32 3/8 13/32 7/16 1/2 9/16 19/32 5/8 11/16 3/4 25/32 13/16 7/8 15/16 1" 1.1/16 1.1/8 1.3/16 1.1/4" <b>H 42 EL-88 A</b>	 <b>1990-5</b> -10  <b>1995</b>	6.9	2546027	D 19 WAU-20

IN 19 PA  
SCREWDRIVER BIT SOCKET SET 1/2"

9 pieces

- > For in-hex screws
- > In GEDORE blue sheet steel case
- > Dimensions: 281 x 79 x 35 mm



12.5

1/2"

"AF"

Sockets		Code	No.
 <b>IN 19</b> 3/16 7/32 1/4 9/32 5/16 3/8 1/2 9/16 5/8"	1.328	6156410	IN 19 PA

Sets 12.5 (1/2") MM+INCH

# D 19 XMAU-20 SOCKET SET 1/2"

31 pieces

- > With forged, tempered UD profile sockets, hand-operated
- > With accessories made from GEDORE vanadium steel 31CrV3
- > With robust lever-change reversible ratchet, with push-button release
- > In GEDORE blue sheet steel case
- > Dimensions: 425 x 277 x 55 mm

12.5  
1/2"  
mm  
"AF"



Ratchet	Sockets	Accessories		Code	No.
U-20 <b>1993 U-20</b>	<b>D 19</b> 11 13 14 17 19 22 24 27 30 32 <b>D 19</b> 3/8 13/32 7/16 1/2 9/16 19/32 5/8 11/16 3/4 25/32 13/16 7/8 15/16 1" 1.1/16 1.1/8"	<b>1987</b> <b>1990-5 -10</b> <b>1995</b>	7.6	2546043	D 19 XMAU-20

Sets 12.5 (1/2") WITHWORTH

# D 19 YWU-20 SOCKET SET 1/2"

14 pieces

- > With forged, tempered bi-hexagon sockets, hand-operated
- > With accessories made from GEDORE vanadium steel 31CrV3
- > With robust lever-change reversible ratchet, with push-button release
- > In GEDORE blue sheet steel case
- > Dimensions: 320 x 210 x 55 mm

12.5  
1/2"  
Whitw.



Ratchet	Sockets	Accessories		Code	No.
U-20 <b>1993 U-20</b>	<b>D 19</b> 3/16 1/4 5/16 3/8 7/16 1/2 9/16 5/8 11/16 3/4W	<b>1990-5 -10</b> <b>1995</b>	3.8	2546035	D 19 YWU-20

## SK 19 MM

SK RATCHET AND SOCKETS  
SK = SOCKET SHORT

- › Especially for working in confined spaces
- › Sockets and ratchet with tubular section for taking up long thread bolts
- › A compact and inner-cavity hexagonal system as the connection between ratchet and socket
- › The sockets are inserted into the ratchet hexagon female drive
- › The drive length is concealed inside the ratchet and shortens the projecting part of the socket by 50 % as against the traditional system
- › Sockets and ratchet hot-drop forged of GEDORE steel
- › Sockets from 10 to 24 mm

19 SKU-20  
SOCKET SET

mm

14 pieces

- › With forged, tempered, hand-operated sockets no. 19 SK with hexagon drive 18.95 mm
- › With reversible lever change ratchet with in-hex drive 19 mm
- › Small, drop shaped head for confined areas
- › Fine-toothed, return angle 6 degrees
- › Non-slip 2-component handle with hanging hole
- › In GEDORE blue sheet steel case
- › Dimensions: 320 x 132 x 55 mm



Ratchet

Sockets



Code

No.

U-20 1993 U-20 SK

19 SK 10 11 12 13 14 15  
16 17 18 19 21 22 24

2.6

2521563

19 SKU-20

# 1993 U-20 SK REVERSIBLE RATCHET

- > Especially for thread bolts and working in confined spaces
- > With hexagon drive
- > Torques specification required to standard DIN 3122 is exceeded
- > Small, drop shaped head for confined areas
- > Fine-toothed (60 teeth), with lever change
- > Return angle 6 degrees
- > Non-slip 2-component handle with hanging hole
- > For hand-operated sockets with hexagon no. 19 SK
- > GEDORE vanadium steel 31CrV3, chrome-plated

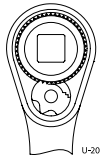

Hexagon	Return angle	Length	Head width	Weight	Code	No.
19	6°	270	21	0.510	2219492	1993 U-20 SK

# 19 SK SOCKET



hexagon, short pattern

- > With hexagon drive size 18.95 mm
- > For use with reversible ratchet no. 1993 U-20 SK
- > Torques specification required to standard DIN 3124 is exceeded
- > GEDORE steel 42CrMo4, chrome-plated

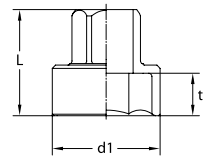

Code	L	d <sub>1</sub>	t	Weight	Code	No.
10	24.0	15.5	6.0	0.040	2521539	19 SK 10
11	24.0	16.7	6.0	0.040	2521547	19 SK 11
12	25.0	18.0	7.0	0.040	2521555	19 SK 12
13	25.0	19.2	7.0	0.040	2225875	19 SK 13
14	25.0	20.5	7.0	0.040	2225883	19 SK 14
15	26.5	21.7	8.5	0.040	2225891	19 SK 15
16	26.5	22.5	8.5	0.091	2225905	19 SK 16
17	27.0	24.0	8.5	0.040	2225913	19 SK 17
18	31.0	25.5	11.0	0.040	2225921	19 SK 18

Code	L	d <sub>1</sub>	t	Weight	Code	No.
19	31.0	26.7	11.0	0.081	2225948	19 SK 19
21	33.0	29.2	13.0	0.040	2225964	19 SK 21
22	33.0	30.5	13.0	0.121	2225972	19 SK 22
24	33.0	33.0	13.0	0.151	2225980	19 SK 24

VDE 1993 U

>575



## Ratchets 12.5 (1/2")

### 1993 U-20 G REVERSIBLE RATCHET 1/2"

with offset handle

- > Used throughout industry and the automotive world - and as well in confined spaces
- > Torque acc. to DIN 3122, ISO 3315
- > Handle offset for barely accessible places
- > Reduces the risk of injury to the fingers when working on flat surfaces
- > Small, drop shaped head for confined areas
- > Fine-toothed (60 teeth), with lever change and push-button release
- > Return angle 6 degrees
- > Non-slip 2-component handle with hanging hole
- > For hand-operated sockets and accessories with square drive as per DIN 3120 - C 12.5, ISO 1174, ball locking device
- > GEDORE vanadium steel 31CrV3, chrome-plated

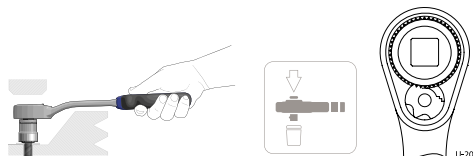

"	mm	°	mm	mm	kg	Code	No.
1/2	12.5	6	270	37.5	0.540	2746786	1993 U-20 G

### 1993 U-20 REVERSIBLE RATCHET 1/2"

- > Used throughout industry and the automotive world - and as well in confined spaces
- > Acc. to DIN 3122, ISO 3315
- > Small, drop shaped head for confined areas
- > Fine-toothed (60 teeth), with lever change and push-button release
- > Return angle 6 degrees
- > Non-slip 2-component handle with hanging hole
- > For hand-operated sockets and accessories with square drive as per DIN 3120 - C 12.5, ISO 1174, ball locking device
- > GEDORE vanadium steel 31CrV3, chrome-plated

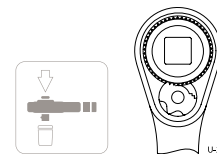

"	mm	°	mm	mm	kg	Code	No.
1/2	12.5	6	270	37.5	0.536	1436686	1993 U-20

### 1993 U-10 L REVERSIBLE RATCHET 1/2"

long pattern

- > For an increase in torque, long design
- > Acc. to DIN 3122, ISO 3315
- > With recessed lever change
- > Push-button release
- > Return angle 7.5 degrees
- > Non-slip 2-component handle with hanging hole
- > Locks in the middle position: When the lever is flipped, it automatically engages for clockwise or anti-clockwise operation
- > For hand-operated sockets and accessories with square drive as per DIN 3120 - C 12.5, ISO 1174, ball locking device
- > GEDORE vanadium steel 31CrV3, chrome-plated

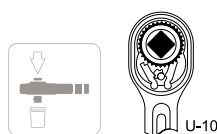

"	mm	°	mm	mm	kg	Code	No.
1/2	12.5	7,5	350	41	0.696	6154550	1993 U-10 L

### 1993 U-10 T REVERSIBLE RATCHET 1/2"

- > Particularly for the demanding use experienced in industry and with utility vehicles
- > Acc. to DIN 3122, ISO 3315
- > With recessed lever change
- > Push-button release
- > Return angle 7.5 degrees
- > Non-slip 2-component handle with hanging hole
- > Locks in the middle position: When the lever is flipped, it automatically engages for clockwise or anti-clockwise operation
- > For hand-operated sockets and accessories with square drive as per DIN 3120 - C 12.5, ISO 1174, ball locking device
- > GEDORE vanadium steel 31CrV3, chrome-plated

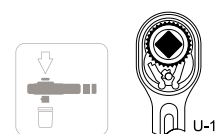

"	mm	°	mm	mm	kg	Code	No.
1/2	12.5	7,5	270	39	0.598	6142620	1993 U-10 T



## LIGHTWEIGHT POWER PACK WITH 100% PERFORMANCE!

- › Particularly suited for tiring overhead work!
- › Its low weight goes easy particularly on one's joints
- › Lightweight yet still of high-strength
- › As with all U-10 ratchets, a mechanism of steel for guaranteed torque transfer as per DIN 3122
- › Hot-drop forged
- › Tough and hard from complex thermal finishing of the aluminium/zinc/magnesium/copper alloy after the demanding forging process

### 1993 ALU-10 ALUMINIUM REVERSIBLE RATCHET 1/2"

- › Very lightweight, especially for work done above your head
- › Design spec. similar to DIN 3122, ISO 3315
- › Made from special-purpose drop-forged and hardened aluminium
- › The mechanism as in all U-10 ratchets is made from high-quality steel
- › With recessed lever change
- › Push-button release
- › Return angle 7.5 degrees
- › Non-slip 2-component handle with hanging hole
- › Locks in the middle position: When the lever is flipped, it automatically engages for clockwise or anti-clockwise operation
- › For hand-operated sockets and accessories with square drive as per DIN 3120 - C 12.5, ISO 1174, ball locking device
- › Extremely lightweight - just 340 g



1/2"	mm	°	mm	mm	kg	Code	No.
1/2	12.5	7,5	270	39	0.340	6142700	1993 ALU-10

### 1993 U-3 REVERSIBLE RATCHET 1/2"

- › Especially for working in confined spaces, as in the automotive business
- › Acc. to DIN 3122, ISO 3315
- › With non-slip metal disc change, fine-toothed (72 teeth) and robust
- › Return angle 5 degrees
- › Non-slip 2-component handle with hanging hole
- › For hand-operated sockets and accessories with square drive as per DIN 3120 - C 12.5, ISO 1174, ball locking device
- › GEDORE vanadium steel 31CrV3, chrome-plated

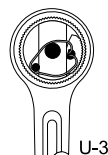

1/2"	mm	°	mm	mm	kg	Code	No.
1/2	12.5	5	270	40.5	0.476	6144240	1993 U-3

### 1993 GU-3 SWIVEL HEAD REVERSIBLE RATCHET 1/2"

- › Especially for use in the automotive sector
- › Swivels through 180°, with joint lock
- › With non-slip metal disc change, fine-toothed (72 teeth) and robust
- › Return angle 5 degrees
- › Non-slip 2-component handle with hanging hole
- › Max. torque 300 N-m
- › For hand-operated sockets and accessories with square drive as per DIN 3120 - C 12.5, ISO 1174, ball locking device
- › GEDORE vanadium steel 31CrV3, chrome-plated

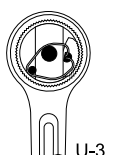

1/2"	mm	°	mm	mm	kg	Code	No.
1/2	12.5	5	282	40.5	0.535	6144320	1993 GU-3



# 1993 GU-10 XL SWIVEL HEAD REVERSIBLE RATCHET 1/2"

extra long

- > Extra long design
- > Ideal for the truck and/or industrial vehicle sectors
- > Swivels through 180°
- > With recessed lever change
- > Push-button release
- > Return angle 7.5 degrees
- > Non-slip 2-component handle with hanging hole
- > Especially suitable for high torques, max. torque 600 N-m
- > Locks in the middle position: When the lever is flipped, it automatically engages for clockwise or anti-clockwise operation
- > For hand-operated sockets and accessories with square drive as per DIN 3120 - C 12.5, ISO 1174, ball locking device
- > GEDORE vanadium steel 31CrV3, chrome-plated



"	mm	°	mm	kg	Code	No.
1/2	12.5	7,5	600	1.160	2018934	1993 GU-10 XL

# 1993 Z-94 RATCHET HANDLE WITH COUPLER 1/2"

- > Used throughout industry and the automotive world
- > Acc. to DIN 3122, ISO 3315
- > With square coupler, medium-fine toothed, extremely rugged
- > Return angle 7.5 degrees
- > Non-slip 2-component handle with hanging hole
- > For hand-operated sockets and accessories with square drive as per DIN 3120 - C 12.5, ISO 1174 ball locking device
- > GEDORE vanadium steel 31CrV3, chrome-plated

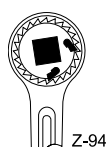

# 1993 U-10 K PLASTIC RATCHET 1/2"

- > For fast and easy tightening of bolted connections up to max. 70 N-m
- > Very handy and compact, housing and handle form one unit
- > Return angle 7.5 degrees
- > Made from sturdy compound material with a steel mechanism
- > Dimensions: 44 x 145 x 42.2 mm



"	mm	°	mm	mm	kg	Code	No.
1/2	12.5	7,5	270	21.9	0.476	6144590	1993 Z-94
1/2	12.5	7,5	145	42.2	0.226	6242760	1993 U-10 K SCHWARZ

Sockets 12.5 (1/2")

19  
SOCKET 1/2"

hexagon UD profile

- > Acc. to DIN 3124, ISO 2725-1
- > Square drive as per DIN 3120 - C 12.5, ISO 1174, with ball retaining groove
- > Hand-operated, knurled grip
- > GEDORE vanadium steel 31CrV3, polished, chrome-plated
- \* not standardised



Ø mm	L	d <sub>1</sub>	d <sub>2</sub>	t	⌀ kg	Code	No.	
8	38.0	13.0	22.5	15.0	0.055	6130020	19 8	
9	*	38.0	14.2	22.5	15.0	0.056	6130100	19 9
10	38.0	15.5	22.5	13.5	0.056	6130290	19 10	
11	38.0	16.7	22.5	12.5	0.058	6130370	19 11	
12	38.0	18.0	22.5	12.5	0.058	6130450	19 12	
13	38.0	19.2	22.5	12.5	0.061	6130530	19 13	
14	38.0	20.5	22.5	12.5	0.063	6130610	19 14	
15	39.5	21.7	23.8	15.0	0.074	6130880	19 15	
16	39.5	22.5	23.8	15.0	0.075	6130960	19 16	
17	39.5	24.0	22.5	15.0	0.074	6131180	19 17	
18	39.5	25.5	23.0	17.0	0.073	6131260	19 18	
19	40.0	26.7	24.2	17.0	0.085	6131340	19 19	
20	40.0	28.0	25.5	17.0	0.096	6131420	19 20	
21	41.5	29.2	26.0	18.5	0.106	6131500	19 21	

Ø mm	L	d <sub>1</sub>	d <sub>2</sub>	t	⌀ kg	Code	No.	
22	41.5	30.5	26.3	18.5	0.112	6131690	19 22	
23	*	41.5	31.7	27.5	18.5	0.122	6131770	19 23
24	41.5	33.0	28.0	18.5	0.132	6131850	19 24	
25	*	41.5	34.2	28.8	18.5	0.139	6131930	19 25
26	*	41.5	35.5	29.4	18.5	0.148	6132070	19 26
27	41.5	36.7	30.0	18.5	0.157	6132150	19 27	
28	*	43.0	38.0	30.5	20.0	0.168	6132230	19 28
29	*	43.0	39.2	31.2	20.0	0.181	6132310	19 29
30	43.0	40.5	32.5	20.5	0.193	6132580	19 30	
32	44.5	43.0	34.5	22.5	0.226	6132740	19 32	
33	*	44.5	44.2	36.0	22.5	0.226	2545306	19 33
34	44.5	45.5	37.0	22.5	0.259	6138270	19 34	
36	*	44.5	48.0	38.0	22.5	0.271	1718711	19 36

19 L  
SOCKET 1/2"

hexagon UD profile, long pattern

- > Acc. to DIN 3124, ISO 2725-1
- > Square drive as per DIN 3120 - C 12.5, ISO 1174, with ball retaining groove
- > Hand-operated, knurled grip
- > GEDORE vanadium steel 31CrV3, polished, chrome-plated



Ø mm	L	d <sub>1</sub>	d <sub>2</sub>	t	⌀ kg	Code	No.
10	77.0	15.5	22.5	12.0	0.117	1718738	19 L 10
11	77.0	16.7	22.5	13.0	0.121	1718746	19 L 11
12	77.0	18.0	22.5	14.0	0.127	1718754	19 L 12
13	77.0	19.2	22.5	16.0	0.098	1718762	19 L 13
14	77.0	20.5	22.5	16.5	0.109	1718770	19 L 14
15	77.0	21.7	22.5	16.5	0.117	1718789	19 L 15
16	77.0	23.0	24.0	16.5	0.130	1718800	19 L 16
17	77.0	24.0	24.0	16.5	0.132	1718819	19 L 17
18	82.0	25.5	25.0	20.0	0.147	1718827	19 L 18
19	82.0	26.7	26.0	22.0	0.174	1718835	19 L 19
21	82.0	29.2	28.5	24.0	0.211	2300559	19 L 21
22	82.0	30.5	28.5	24.0	0.219	2300567	19 L 22
24	82.0	33.0	29.0	26.0	0.257	2300575	19 L 24
27	82.0	36.7	30.0	30.0	0.290	2300583	19 L 27
30	82.0	40.5	32.5	33.0	0.351	2300591	19 L 30

Ø mm	L	d <sub>1</sub>	d <sub>2</sub>	t	⌀ kg	Code	No.
32	82.0	43.0	34.5	36.0	0.387	2300605	19 L 32
34	82.0	45.5	36.5	37.0	0.432	2300613	19 L 34



# D 19 (MM)

## SOCKET 1/2"

bi-hexagon UD profile

- > Acc. to DIN 3124, ISO 2725-1
  - > Square drive as per DIN 3120 - C 12.5, ISO 1174, with ball retaining groove
  - > Hand-operated, knurled grip
  - > GEDORE vanadium steel 31CrV3, polished, chrome-plated
- \* not standardised

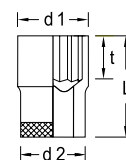

Ø mm	L	d <sub>1</sub>	d <sub>2</sub>	t	⚖	Code	No.
8	38.0	13.0	22.5	7.0	0.051	6133040	D 19 8
9	* 38.0	14.2	22.5	8.0	0.052	6133120	D 19 9
10	38.0	15.5	22.5	13.5	0.056	6133200	D 19 10
11	38.0	16.7	22.5	12.5	0.057	6133390	D 19 11
12	38.0	18.0	22.5	12.5	0.057	6133470	D 19 12
13	38.0	19.2	22.5	12.5	0.059	6133550	D 19 13
14	38.0	20.5	22.5	12.5	0.061	6133630	D 19 14
15	39.5	21.7	23.8	15.0	0.072	6133710	D 19 15
16	39.5	22.5	23.8	15.0	0.072	6133980	D 19 16
17	39.5	24.0	22.5	15.0	0.070	6134010	D 19 17
18	39.5	25.5	23.0	17.0	0.068	6134280	D 19 18
19	40.0	26.7	24.2	17.0	0.081	6134360	D 19 19
20	40.0	28.0	25.5	17.0	0.090	6134440	D 19 20
21	41.5	29.2	26.0	18.5	0.101	6134520	D 19 21

Ø mm	L	d <sub>1</sub>	d <sub>2</sub>	t	⚖	Code	No.
22	41.5	30.5	26.3	18.5	0.106	6134600	D 19 22
23	* 41.5	31.7	27.5	18.5	0.118	6134790	D 19 23
24	41.5	33.0	28.0	18.5	0.123	6134870	D 19 24
25	* 41.5	34.2	28.8	18.5	0.131	6134950	D 19 25
26	* 41.5	35.5	29.4	18.5	0.139	6135090	D 19 26
27	41.5	36.7	30.0	18.5	0.143	6135170	D 19 27
28	* 43.0	38.0	30.5	20.0	0.163	6135250	D 19 28
29	* 43.0	39.2	31.2	20.0	0.168	6135330	D 19 29
30	43.0	40.5	32.5	20.5	0.182	6135410	D 19 30
32	44.5	43.0	34.5	22.5	0.204	6135760	D 19 32
33	* 44.5	44.2	36.0	22.5	0.221	6135840	D 19 33
34	* 44.5	45.5	37.0	22.5	0.251	2545314	D 19 34
36	* 44.5	48.0	38.0	22.5	0.271	2194686	D 19 36

# D 19 (AF)

## SOCKET 1/2"

bi-hexagon UD profile

- > Square drive as per DIN 3120 - C 12.5, ISO 1174, with ball retaining groove
- > Hand-operated, knurled grip
- > GEDORE vanadium steel 31CrV3, polished, chrome-plated

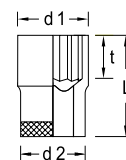

Ø AF	L	d <sub>1</sub>	d <sub>2</sub>	t	⚖	Code	No.
5/16	38.0	13.0	22.5	7.0	0.052	6136060	D 19 5/16AF
11/32	38.0	13.9	22.5	8.0	0.054	6136140	D 19 11/32AF
3/8	38.0	14.9	22.5	15.0	0.055	6136220	D 19 3/8AF
13/32	38.0	15.9	22.5	13.5	0.055	6136300	D 19 13/32AF
7/16	38.0	16.7	22.5	12.5	0.056	6136490	D 19 7/16AF
1/2	38.0	18.7	22.5	12.5	0.058	6136570	D 19 1/2AF
9/16	38.0	20.7	22.5	12.5	0.061	6136650	D 19 9/16AF
19/32	39.5	21.7	23.8	15.0	0.070	6136730	D 19 19/32AF
5/8	39.5	22.5	23.8	15.0	0.073	6136810	D 19 5/8AF
11/16	39.5	24.7	22.5	17.0	0.066	6137030	D 19 11/16AF
3/4	40.0	26.7	24.2	17.0	0.084	6137110	D 19 3/4AF
25/32	40.0	27.7	25.3	17.0	0.090	6137380	D 19 25/32AF
13/16	41.5	28.5	25.7	18.5	0.097	6137460	D 19 13/16AF
7/8	41.5	30.6	26.5	18.5	0.105	6137540	D 19 7/8AF
15/16	41.5	32.6	28.3	18.5	0.126	6137620	D 19 15/16AF

Ø AF	L	d <sub>1</sub>	d <sub>2</sub>	t	⚖	Code	No.
1	41.5	34.6	28.9	18.5	0.138	6137700	D 19 1AF
1.1/16	41.5	36.7	30.0	18.5	0.147	6137890	D 19 1.1/16AF
1.1/8	43.0	38.6	31.0	20.0	0.159	6137970	D 19 1.1/8AF
1.3/16	43.0	40.6	32.5	20.5	0.183	6138000	D 19 1.3/16AF
1.1/4	44.5	42.6	34.5	22.5	0.207	6138190	D 19 1.1/4AF

## D 19 (WW) SOCKET 1/2"

bi-hexagon

- > Square drive as per DIN 3120 - C 12.5, ISO 1174, with ball retaining groove
- > Hand-operated, knurled grip
- > GEDORE vanadium steel 31CrV3, polished, chrome-plated

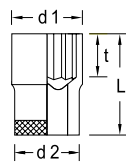

Whitw.	L	d <sub>1</sub>	d <sub>2</sub>	t	$\frac{kg}{mm^3}$	Code	No.
3/16	38.0	17.0	22.5	12.5	0.054	6138780	D 19 3/16W
1/4	38.0	19.5	22.5	12.5	0.057	6138860	D 19 1/4W
5/16	39.5	21.9	23.8	15.0	0.069	6138940	D 19 5/16W
3/8	39.5	25.5	23.0	17.0	0.066	6139080	D 19 3/8W
7/16	41.5	28.8	26.0	18.5	0.096	6139160	D 19 7/16W
1/2	41.5	32.1	27.8	18.5	0.124	6139240	D 19 1/2W
9/16	41.5	34.9	29.2	18.5	0.137	6139320	D 19 9/16W
5/8	43.0	37.8	30.5	20.0	0.166	6139400	D 19 5/8W
11/16	43.0	41.0	33.0	20.5	0.184	6139590	D 19 11/16W
3/4	44.5	44.2	36.0	22.5	0.225	6138430	D 19 3/4W



## D 19 L (MM) SOCKET 1/2"

bi-hexagon UD profile, long pattern

- > Acc. to DIN 3124, ISO 2725-1
- > Square drive as per DIN 3120 - C 12.5, ISO 1174, with ball retaining groove
- > Hand-operated, knurled grip
- > GEDORE vanadium steel 31CrV3, polished, chrome-plated
- > Sizes 16, 18, 21 mm with hole drilled for tommy bar Ø 8 mm

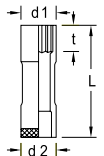

Ø mm	L	d <sub>1</sub>	d <sub>2</sub>	t	$\frac{kg}{mm^3}$	Code	No.
10	77.0	15.5	22.5	12.0	0.117	6141140	D 19 L 10
12	77.0	18.0	22.5	14.0	0.127	6141220	D 19 L 12
13	77.0	19.2	22.5	16.0	0.101	6140170	D 19 L 13
14	77.0	20.5	22.5	16.5	0.109	6140250	D 19 L 14
15	77.0	21.7	22.5	16.5	0.119	6142460	D 19 L 15
16	77.0	23.0	24.0	16.5	0.128	6142540	D 19 L 16
17	77.0	24.0	24.0	16.5	0.133	6140330	D 19 L 17
18	82.0	25.5	25.0	20.0	0.147	6142380	D 19 L 18
19	82.0	26.7	26.0	22.0	0.175	6140410	D 19 L 19
21	82.0	29.2	28.5	24.0	0.211	6140680	D 19 L 21
22	82.0	30.5	28.5	24.0	0.219	6145050	D 19 L 22
24	82.0	33.0	29.0	26.0	0.257	6140760	D 19 L 24
27	82.0	36.7	30.0	30.0	0.290	6141060	D 19 L 27
30	82.0	40.5	32.5	33.0	0.351	6145640	D 19 L 30
32	82.0	43.0	34.5	36.0	0.387	6191320	D 19 L 32
34	82.0	45.5	36.5	37.0	0.432	6147500	D 19 L 34

## D 19 L (AF) SOCKET 1/2"

bi-hexagon UD profile, long pattern

- > Square drive as per DIN 3120 - C 12.5, ISO 1174, with ball retaining groove
- > Hand-operated, knurled grip
- > GEDORE vanadium steel 31CrV3, polished, chrome-plated



D 19 L 19

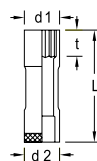

AF	L	d <sub>1</sub>	d <sub>2</sub>	t	$\frac{kg}{mm^3}$	Code	No.
1/2	77.0	18.7	22.5	16.0	0.095	6141300	D 19 L 1/2AF
9/16	77.0	20.7	22.5	16.5	0.105	6141490	D 19 L 9/16AF
5/8	77.0	22.5	24.0	16.5	0.120	6141570	D 19 L 5/8AF
11/16	77.0	24.7	24.8	16.5	0.143	6141650	D 19 L 11/16AF
3/4	82.0	26.7	26.0	22.0	0.164	6141730	D 19 L 3/4AF
13/16	82.0	28.5	28.5	22.0	0.197	6141810	D 19 L 13/16AF
7/8	82.0	30.6	28.5	24.0	0.208	6142030	D 19 L 7/8AF
15/16	82.0	32.6	29.0	26.0	0.234	6142110	D 19 L 15/16AF



## TX 19 SOCKET 1/2"

for protruding TORX® head screws

- > Square drive as per DIN 3120 - C 12.5, ISO 1174, with ball retaining groove
- > Hand-operated, knurled grip
- > GEDORE vanadium steel 31CrV3, polished, chrome-plated
- > TORX® = reg. trademark of Acument Intellectual Properties, LLC. USA



TX 19 E10



TX 19 E18

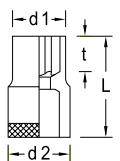

TX	M	mm	L	d <sub>1</sub>	d <sub>2</sub>	t	$\frac{kg}{mm^3}$	Code	No.
E10	M8	9,42	38.0	13.5	22.5	15.5	0.056	6145720	TX 19 E10
E11	-	10,08	38.0	14.0	22.5	15.5	0.055	6194180	TX 19 E11
E12	M10	11,17	38.0	15.5	22.5	15.5	0.059	6147340	TX 19 E12
E14	M12	12,90	38.0	17.0	22.5	13.0	0.059	6147420	TX 19 E14
E16	M12	14,76	38.0	19.0	22.5	13.0	0.062	6194420	TX 19 E16
E18	M14	16,70	40.0	21.0	24.5	14.0	0.078	6194500	TX 19 E18
E20	M16	18,45	40.0	23.5	24.5	14.0	0.085	6194690	TX 19 E20
E24	M18 - M20	22,16	41.5	28.5	26.0	16.0	0.116	6195070	TX 19 E24

# ITX 19 SCREWDRIVER BIT SOCKET 1/2"

12.5  
1/2"

for recessed TORX® head screws

- > Square drive as per DIN 3120 - C 12.5, ISO 1174, with ball retaining groove
- > Hand-operated, knurled grip
- > Chrome-plated
- > With pressed-in pin in GEDORE vanadium special steel, gun-metal finish
- > TORX® = reg. trademark of Acument Intellectual Properties, LLC. USA

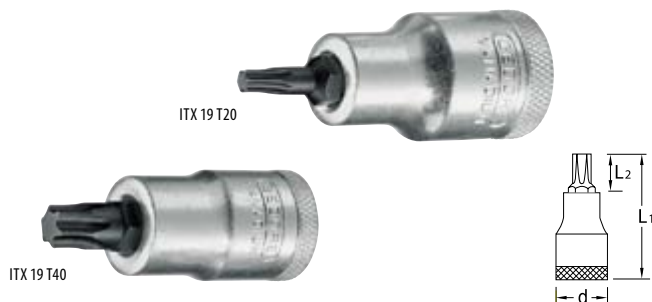

⊕	M	mm	L <sub>1</sub>	L <sub>2</sub>	d	kg	Code	No.
T20	M4 - M5	3,86	55	17	22.5	0.076	6152930	ITX 19 T20
T25	M4,5 - M5	4,43	55	17	22.5	0.075	6154200	ITX 19 T25
T27	M4,5 - M6	4,99	55	17	22.5	0.076	6154630	ITX 19 T27
T30	M6 - M7	5,52	55	17	22.5	0.075	6156170	ITX 19 T30
T40	M7 - M8	6,65	55	17	22.5	0.076	6156330	ITX 19 T40
T45	M8 - M10	7,82	55	17	22.5	0.077	6157060	ITX 19 T45
T50	M10	8,83	55	17	22.5	0.092	6158030	ITX 19 T50
T55	M12	11,22	55	17	23.0	0.107	6158380	ITX 19 T55
T60	M14	13,25	55	15	24.7	0.137	6158540	ITX 19 T60

# ITX 19 L SCREWDRIVER BIT SOCKET 1/2"

12.5  
1/2"

for recessed TORX® head screws, long pattern

- > Square drive as per DIN 3120 - C 12.5, ISO 1174, with ball retaining groove
- > Hand-operated, knurled grip
- > Chrome-plated
- > With pressed-in pin in GEDORE vanadium special steel, gun-metal finish
- > TORX® = reg. trademark of Acument Intellectual Properties, LLC. USA



⊕	M	mm	L <sub>1</sub>	L <sub>2</sub>	d	kg	Code	No.
T20	M4 - M5	3,86	100	62	22.5	0.095	6188020	ITX 19 L T20-100
T25	M4,5 - M5	4,43	100	62	22.5	0.095	6188100	ITX 19 L T25-100
T27	M4,5 - M6	4,99	100	62	22.5	0.096	6188370	ITX 19 L T27-100
T30	M6 - M7	5,52	100	62	22.5	0.096	6152500	ITX 19 L T30-100
T40	M7 - M8	6,65	100	62	22.5	0.096	6152690	ITX 19 L T40-100
T45	M8 - M10	7,82	100	62	22.5	0.098	6155870	ITX 19 L T45-100
T50	M10	8,83	100	62	22.5	0.124	6158700	ITX 19 L T50-100
T55	M12	11,22	100	62	23.0	0.151	6159940	ITX 19 L T55-100
T60	M14	13,25	100	60	24.7	0.197	6188450	ITX 19 L T60-100
T70	M16	15,55	100	60	28.0	0.277	6105180	ITX 19 L T70-100

# ITX 19 B SCREWDRIVER BIT SOCKET 1/2"

12.5  
1/2"

for recessed TORX® head screws with pilot

- > Square drive as per DIN 3120 - C 12.5, ISO 1174, with ball retaining groove
- > Hand-operated, knurled grip
- > Chrome-plated

- > With pressed-in pin in GEDORE vanadium special steel, gun-metal finish
- > TORX® = reg. trademark of Acument Intellectual Properties, LLC. USA



⊕	M	mm	L <sub>1</sub>	L <sub>2</sub>	d	Bore mm	kg	Code	No.
T20	M4 - M5	3,86	55	17	22.5	1,55 x 1,86	0.075	6192720	ITX 19 B T20
T25	M4,5 - M5	4,43	55	17	22.5	1,93 x 2,04	0.075	6195660	ITX 19 B T25
T27	M4,5 - M6	4,99	55	17	22.5	2,18 x 2,29	0.076	6196390	ITX 19 B T27
T30	M6 - M7	5,52	55	17	22.5	2,56 x 2,92	0.076	6200170	ITX 19 B T30
T40	M7 - M8	6,65	55	17	22.5	2,92 x 3,28	0.091	6200410	ITX 19 B T40
T45	M8 - M10	7,82	55	17	22.5	3,45 x 3,68	0.092	6200840	ITX 19 B T45
T50	M10	8,83	55	17	23.0	3,83 x 3,78	0.105	6201300	ITX 19 B T50
T55	M12	11,22	55	15	24.7	4,85 x 4,79	0.133	6202700	ITX 19 B T55
T60	M14	13,25	56	16	28.0	5,63 x 7,87	0.182	6203270	ITX 19 B T60

## 1500 CT1-ITX 19 LKP

> 109



# IS 19 SCREWDRIVER BIT SOCKET 1/2"

12.5  
1/2"

for slotted head screws

- > Square drive as per DIN 3120 - C 12.5, ISO 1174, with ball retaining groove
- > Hand-operated, knurled grip
- > Chrome-plated
- > With pressed-in pin in GEDORE vanadium special steel, manganese-phosphated
- > Blade as per DIN ISO 2380-1, Form B

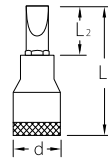

mm	mm	L <sub>1</sub>	L <sub>2</sub>	d	kg	Code	No.
6.5	1.2	60	22	22.5	0.071	6161760	IS 19 6,5x1,2
8.0	1.2	60	22	22.5	0.080	6656060	IS 19 8x1,2
10.0	1.6	60	22	22.5	0.115	6656140	IS 19 10x1,6
12.0	2.0	60	22	23.0	0.110	6656220	IS 19 12x2
14.0	2.5	60	20	24.7	0.138	6162140	IS 19 14x2,5
16.0	2.5	60	20	28.0	0.190	6656490	IS 19 16x2,5
18.0	2.5	60	20	27.0	0.193	6656570	IS 19 18x2,5

# IKS 19 SCREWDRIVER BIT SOCKET 1/2"

12.5  
1/2"

for cross-head screws PH

- > Square drive as per DIN 3120 - C 12.5, ISO 1174, with ball retaining groove
- > Hand-operated, knurled grip
- > Chrome-plated
- > With pressed-in pin in GEDORE vanadium special steel, gun-metal finish
- > Tip as per DIN ISO 8764-1 PH

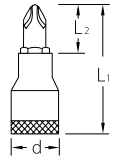

PH	L <sub>1</sub>	L <sub>2</sub>	d	kg	Code	No.
2	60	22	22.5	0.077	6656650	IKS 19 2
3	60	22	22.5	0.092	6656730	IKS 19 3
4	60	22	23.0	0.106	6656810	IKS 19 4

# IKS 19 PZD SCREWDRIVER BIT SOCKET 1/2"

12.5  
1/2"

for cross-head screws Pozi PZ

- > Square drive as per DIN 3120 - C 12.5, ISO 1174, with ball retaining groove
- > Hand-operated, knurled grip
- > Chrome-plated
- > With pressed-in pin in GEDORE vanadium special steel, gun-metal finish
- > Tip as per DIN ISO 8764-1 PZ

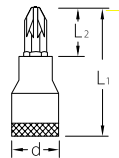

PZ	L <sub>1</sub>	L <sub>2</sub>	d	kg	Code	No.
2	60	22	22.5	0.077	6156680	IKS 19 PZD 2
3	60	22	22.5	0.091	6156760	IKS 19 PZD 3
4	60	22	23.0	0.108	6156840	IKS 19 PZD 4

# IN 19 (MM) SCREWDRIVER BIT SOCKET 1/2"

12.5  
1/2"

for in-hex screws

- > Acc. to DIN 7422
- > Square drive as per DIN 3120 - C 12.5, ISO 1174, with ball retaining groove
- > Hand-operated, knurled grip
- > Chrome-plated
- > With pressed-in pin in GEDORE vanadium special steel, manganese-phosphated
- > IN 19 17 for oil filter and drain plug screws
- \* not standardised

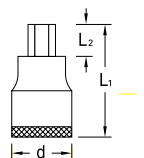

mm	L <sub>1</sub>	L <sub>2</sub>	d	kg	Code	No.
4	*	60	22	0.068	6153070	IN 19 4
5	*	60	22	0.069	6153150	IN 19 5
6		60	22	0.070	6153230	IN 19 6
7		60	22	0.075	6153310	IN 19 7
8		60	22	0.082	6153580	IN 19 8
9	*	60	22	0.091	6153660	IN 19 9
10		60	22	0.099	6153740	IN 19 10
12		60	22	0.113	6153820	IN 19 12
14		60	20	0.149	6153900	IN 19 14
17	*	60	20	0.210	6154040	IN 19 17
19	*	60	20	0.222	6154120	IN 19 19

VDE IN 19

>574





# IN 19 L SCREWDRIVER BIT SOCKET 1/2"

12.5  
1/2"

for in-hex screws, long pattern

- > Acc. to DIN 7422
- > Square drive as per DIN 3120 - C 12.5, ISO 1174, with ball retaining groove
- > Hand-operated, knurled grip
- > Chrome-plated

- > With pressed-in pin in GEDORE vanadium special steel, manganese-phosphated
- \* t = stepped hexagon bit 13 mm
- \* not standardised

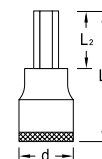

mm	L <sub>1</sub>	L <sub>2</sub>	d	* t		Code	No.	
5	*	90	52	22.5	13	0.091	6162060	IN 19 L 5-90
5	*	180	142	22.5	13	0.131	6157140	IN 19 L 5-180
6		90	52	22.5		0.079	6157300	IN 19 L 6-90
6		140	102	22.5	13	0.115	6145800	IN 19 L 6-140
6		160	122	22.5	13	0.123	6145990	IN 19 L 6-160
7		100	62	22.5		0.089	6157570	IN 19 L 7-100
7	*	140	102	22.5			2950960	IN 19 L 7-140
8		90	52	22.5		0.095	6157730	IN 19 L 8-90

mm	L <sub>1</sub>	L <sub>2</sub>	d	* t		Code	No.	
8		120	82	22.5		0.109	6157810	IN 19 L 8-120
8	*	140	102	22.5			2951533	IN 19 L 8-140
9	*	140	102	22.5			2950979	IN 19 L 9-140
10		140	102	22.5		0.154	6158110	IN 19 L 10-140
12		140	102	23.0		0.195	6158460	IN 19 L 12-140
14		140	100	24.7		0.257	6158620	IN 19 L 14-140

# IN 19 (AF) SCREWDRIVER BIT SOCKET 1/2"

12.5  
1/2"

for in-hex screws

- > Square drive as per DIN 3120 - C 12.5, ISO 1174, with ball retaining groove
- > Hand-operated, knurled grip
- > Chrome-plated
- > With pressed-in pin in GEDORE vanadium special steel, manganese-phosphated

# IN 19 K SCREWDRIVER BIT SOCKET 1/2"

12.5  
1/2"

with ball end, for in-hex screws

- > Square drive as per DIN 3120 - C 12.5, ISO 1174, with ball retaining groove
- > Hand-operated, knurled grip
- > Chrome-plated
- > With pressed-in pin in GEDORE vanadium special steel, gun-metal finish
- > Total swivel angle approx. 15-20°



IN 19 1/2

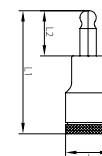
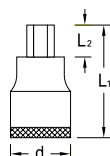

AF	L <sub>1</sub>	L <sub>2</sub>	d		Code	No.
3/16	60	22	22.5	0.069	6154710	IN 19 3/16AF
7/32	60	22	22.5	0.069	6154980	IN 19 7/32AF
1/4	60	22	22.5	0.073	6155010	IN 19 1/4AF
9/32	60	22	22.5	0.076	6155280	IN 19 9/32AF
5/16	60	22	22.5	0.081	6155360	IN 19 5/16AF
3/8	60	22	22.5	0.098	6155440	IN 19 3/8AF
1/2	60	22	23.0	0.119	6155520	IN 19 1/2AF
9/16	60	20	24.7	0.150	6155600	IN 19 9/16AF
5/8	60	20	28.0	0.205	6155790	IN 19 5/8AF

mm	L <sub>1</sub>	L <sub>2</sub>	d		Code	No.
6	60	22	22.5	0.068	2219336	IN 19 K 6
7	60	22	22.5	0.071	2219360	IN 19 K 7
8	60	22	22.5	0.080	2219379	IN 19 K 8
10	60	22	22.5	0.100	2219395	IN 19 K 10
12	60	20	23.0	0.190	1621513	IN 19 K 12
14	60	20	24.7	0.220	2663090	IN 19 K 14

## IN 19 LK SCREWDRIVER BIT SOCKET 1/2"

12.5  
1/2"

with ball end, for in-hex screws, long pattern

- > Square drive as per DIN 3120 - C 12.5, ISO 1174, with ball retaining groove
- > Hand-operated, knurled grip
- > Chrome-plated
- > With pressed-in pin in GEDORE vanadium special steel, gun-metal finish
- > Total swivel angle approx. 15-20°

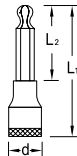

mm	L <sub>1</sub>	L <sub>2</sub>	d	kg	Code	No.
6	140	102	22.5	0.091	6162810	IN 19 LK 6-140
7	140	102	22.5	0.103	6165080	IN 19 LK 7-140
8	140	102	22.5	0.116	6165160	IN 19 LK 8-140
10	140	102	22.5	0.153	6166800	IN 19 LK 10-140
12	140	102	23.0	0.195	6172370	IN 19 LK 12-140
14	140	100	24.7	0.225	1936328	IN 19 LK 14-140

## INR 19 L SCREWDRIVER BIT SOCKET 1/2"

12.5  
1/2"

for multi-spline screws RIBE®, long pattern

- > RIBE® = reg. trademark of Richard Bergner GmbH & Co. KG, Schwabach, Germany



INR 19 L 5-100



INR 19 L 14-100

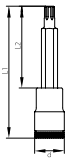

M	L <sub>1</sub>	L <sub>2</sub>	d	kg	Code	No.
M5	100	62	22.5	0.085	1449826	INR 19 L 5-100
M6	100	62	22.5	0.085	1449850	INR 19 L 6-100
M6	188	150	22.5	0.120	1450859	INR 19 L 6-188
M8	100	62	22.5	0.085	1449877	INR 19 L 8-100
M8	188	150	22.5	0.125	1450875	INR 19 L 8-188
M10	100	62	22.5	0.105	1449591	INR 19 L 10-100
M10	188	150	22.5	0.165	1450891	INR 19 L 10-188
M12	100	62	22.5	0.145	1398636	INR 19 L 12-100
M12	188	150	22.5	0.230	1450913	INR 19 L 12-188
M14	100	60	24.7	0.155	1449893	INR 19 L 14-100

## INX 19 SCREWDRIVER BIT SOCKET 1/2"

12.5  
1/2"

for multi-point screws XZN

- > Acc. to DIN 2324
- > Square drive as per DIN 3120 - C 12.5, ISO 1174, with ball retaining groove
- > Hand-operated, knurled grip
- > Chrome-plated
- > With pressed-in pin in GEDORE vanadium special steel, manganese-phosphated
- > Tip as per DIN 2325
- \* not standardised

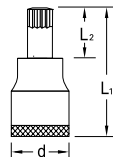

M	L <sub>1</sub>	L <sub>2</sub>	d	kg	Code	No.	
M5	*	55	17	22.5	0.075	6158890	INX 19 5
M6	*	55	17	22.5	0.076	6159000	INX 19 6
M8		55	17	22.5	0.077	6159270	INX 19 8
M10		55	17	22.5	0.094	6159430	INX 19 10
M12		55	17	23.0	0.110	6159780	INX 19 12
M14		57	17	24.7	0.140	1888943	INX 19 14
M16	*	60	20	24.7		2950944	INX 19 16
M18	*	60	20	24.7		2950952	INX 19 18

## INX 19 L SCREWDRIVER BIT SOCKET 1/2"

12.5  
1/2"

for multi-point screws XZN, long pattern

- > Acc. to DIN 2324
- > Square drive as per DIN 3120 - C 12.5, ISO 1174, with ball retaining groove
- > Hand-operated, knurled grip
- > Chrome-plated
- > With pressed-in pin in GEDORE vanadium special steel, manganese-phosphated
- > Tip as per DIN 2325
- \* not standardised

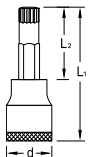

M	L <sub>1</sub>	L <sub>2</sub>	d	kg	Code	No.	
M6	*	100	62	22.5	0.093	6159190	INX 19 L 6-100
M8		100	62	22.5	0.097	6159350	INX 19 L 8-100
M10		100	62	22.5	0.124	6159510	INX 19 L 10-100
M12		100	62	23.0	0.149	6159860	INX 19 L 12-100
M14		100	60	24.7	0.110	1888951	INX 19 L 14-100

## Accessories 12.5 (1/2")

### 1985 SPEED BRACE 1/2"

- > Acc. to DIN 3122, ISO 3315
- > For hand-operated sockets with square drive as per DIN 3120, ISO 1174, with ball locking device
- > GEDORE vanadium steel 31CrV3, polished, chrome-plated



"	mm	mm	kg	Code	No.
1/2	12.5	395	0.619	6143350	1985

### 1998 SWIVEL HANDLE WITH SLIDING T 1/2"

- > For hand-operated sockets with square drive as per DIN 3120, ISO 1174, with ball locking device
- > GEDORE vanadium steel 31CrV3, chrome-plated, polished



"	mm	mm	kg	Code	No.
1/2	12.5	460	0.747	6199730	1998

### 1996 - 1997 SWIVEL HANDLE 1/2"

- > Acc. to DIN 3122, ISO 3315
- > Non-slip 2-component handle with hanging hole
- > For hand-operated sockets with square drive as per DIN 3120, ISO 1174, with ball locking device
- > GEDORE vanadium steel 31CrV3, chrome-plated, polished



1996



1997

"	mm	mm	kg	Code	No.
1/2	12.5	255	0.426	6144830	1996

"	mm	mm	kg	Code	No.
1/2	12.5	381	0.593	6144910	1997

### 1987 SLIDING T BAR 1/2"

- > Acc. to DIN 3122, ISO 3315
- > For hand-operated sockets with square drive as per DIN 3120, ISO 1174, with ball locking device
- > GEDORE vanadium steel 31CrV3, polished, chrome-plated



"	mm	mm	kg	Code	No.
1/2	12.5	292	0.386	6143430	1987

### 1981 K L-HANDLE 1/2"

- > Acc. to DIN 3122, ISO 3315
- > For hand-operated sockets with square drive as per DIN 3120, ISO 1174, with ball locking device
- > GEDORE vanadium steel 31CrV3, polished, chrome-plated



"	mm	mm	kg	Code	No.
1/2	12.5	220	0.267	6143270	1981 K

## 1987 A SLIDING T BAR WITH RELEASE 1/2"

- > Secured against unintentional removal
- > GEDORE vanadium steel 31CrV3, polished, chrome-plated
- > Turn handle for easy locking and releasing
- > Accidental release when working is prevented because of the asymmetrical release point
- > Particularly useful for work in sensitive areas where certainty against loss is a theme
- > Examples: Aircraft engine, work in deep machine bodies
- > DBGM (German utility patent)



1/2"	12.5	292	0.375	Code	No.
1/2	12.5	292	0.375	1871641	1987 A

## 1990 EXTENSION 1/2"

- > Acc. to DIN 3123, ISO 3316
- > For hand-operated sockets with square drive as per DIN 3120, ISO 1174, with ball locking device
- > GEDORE vanadium steel 31CrV3, chrome-plated
- \* not standardised



1990-2.1/2



1990-3



1990-5



1990-7



1990-10

1/2"	12.5	*	63	0.115	Code	No.
1/2	12.5	*	63	0.115	6143510	1990-2.1/2
1/2	12.5		76	0.137	6143780	1990-3
1/2	12.5		125	0.188	6143860	1990-5

1/2"	12.5	*	180	0.264	Code	No.
1/2	12.5	*	180	0.264	6142890	1990-7
1/2	12.5		250	0.361	6143940	1990-10
1/2	12.5	*	305	0.411	6129950	1990-12

## 1990 A EXTENSION 1/2"

with release

- > Easy access to deep-fitting screws
- > Locking ring prevents unintentional release of the socket
- > For hand-operated sockets with square drive as per DIN 3120, ISO 1174, with ball locking device



1990 A-5



1990 A-10



1/2"	12.5	125	0.216	Code	No.
1/2	12.5	125	0.216	1640828	1990 A-5

1/2"	12.5	250	0.386	Code	No.
1/2	12.5	250	0.386	1640801	1990 A-10

## 1990 KR UNIVERSAL EXTENSION 1/2"

- > With ball end
- > For hand-operated sockets with square drive as per DIN 3120, ISO 1174, with ball locking device
- > The extension is able to pivot up to 15°
- > Load capacity max. 230 N-m
- > GEDORE vanadium steel 31CrV3, polished, chrome-plated



1990 KR-5



1990 KR-7



1990 KR-10

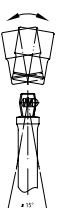

1/2"	12.5	125	0.180	Code	No.
1/2	12.5	125	0.180	6173180	1990 KR-5
1/2	12.5	180	0.255	6225590	1990 KR-7

1/2"	12.5	250	0.345	Code	No.
1/2	12.5	250	0.345	6366570	1990 KR-10

## 1990 M EXTENSION 1/2"

with magnet

- > For hand-operated sockets with square drive as per DIN 3120, ISO 1174, with ball locking device
- > The holding magnet securely fixes the screws or nuts in the socket
- > One-hand operation - using the socket the screw or nut can be immediately screwed in
- > Thanks to a spring mechanism the holding magnet is always in direct contact with the screw head. It ensures that the screw is centrally guided
- > A strong permanent magnet keeps hold of even large screws
- > Makes work easier particularly in confined spaces
- > Hot forged
- > GEDORE vanadium steel 31CrV3, polished



EISEN 2014  
INNOVATION-AWARD



"	"	mm	kg	Code	No.
1/2	12.5	81.5	0.110	2697920	1990 M

## 1995 UNIVERSAL JOINT 1/2"

- > Acc. to DIN 3123, ISO 3316
- > For hand-operated sockets with square drive as per DIN 3120, ISO 1174, with ball locking device
- > GEDORE vanadium steel 31CrV3, chrome-plated, polished



"	"	"	"	mm	kg	Code	No.
1/2	12.5	1/2	12.5	72	0.159	6144750	1995

## 1930 REDUCER 1/2" TO 3/8"

- > Acc. to DIN 3123, ISO 3316
- > For hand-operated sockets with square drive as per DIN 3120, ISO 1174, with ball locking device
- > GEDORE vanadium steel 31CrV3, polished, chrome-plated



"	"	"	"	mm	kg	Code	No.
1/2	12.5	3/8	10	38.5	0.062	6143000	1930

## 1994 COUPLER 1/2"

- > Acc. to DIN 3122, ISO 3315
- > For hand-operated sockets with square drive as per DIN 3120, ISO 1174, with ball locking device
- > GEDORE vanadium steel 31CrV3, chrome-plated, polished



"	"	mm	kg	Code	No.
1/2	12.5	38	0.045	6144670	1994

## 1932 CONVERTOR 1/2" TO 3/4"

- > Acc. to DIN 3123, ISO 3316
- > For hand-operated sockets with square drive as per DIN 3120, ISO 1174, with ball locking device
- > GEDORE vanadium steel 31CrV3, polished, chrome-plated



"	"	"	"	mm	kg	Code	No.
1/2	12.5	3/4	20	44	0.128	6143190	1932

## 1940 HIGH-SPEED SWIVEL DISC for 1/2" ratchets

- > For 12.5 mm (1/2") ratchets
- > Tightens loose screws with a flick of the wrist
- > Easy assembly between release head and socket
- > Speeds up the screwing process

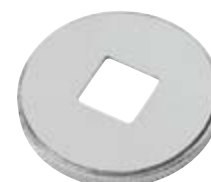

"	"	kg	Code	No.
1/2	12.5	0.014	1640887	1940



# 1990 M UNIVERSAL EXTENSION WITH MAGNETIC EFFECT



### Your advantage:

- > Secure fixing even of large screws
- > One-handed operation Using the socket, the screw can be immediately screwed in
- > Powerful magnet with spring mechanism ensures centric screw guidance.
- > Makes work easier particularly in confined spaces

> The essentially plain-looking universal extension in combination, for instance, with the right sockets and socket drivers is transformed into our secret star.

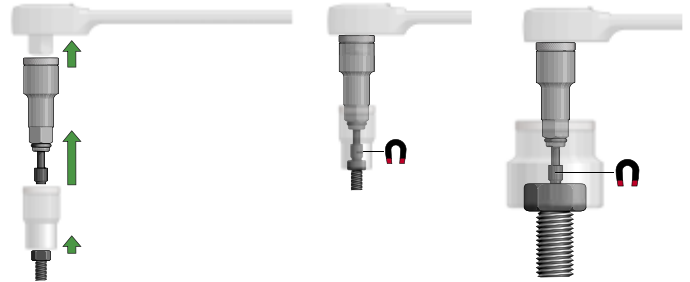

# SL 19 TOOL HOLDING RAIL, MAGNETIC 1/2"

empty

- > External squares to take 12 or 16 standard commercial 12.5 mm (1/2") sockets
- > Two female square adaptors to take ratchets, sliding T bars, extensions etc.
- > A strong magnet securely holds the socket rail to ferrous metals
- > Additional holes are provided for wall mounting the socket rail or attaching to non-ferrous materials
- > The sockets are securely locked by the ball at the square-drive end by turning them 90°

- > It is a simple matter to "unlock" and remove the sockets, by turning them 90° in the opposing direction
- > Delivery without tools



Execution	↳ mm	mm	kg	Code	No.
for 12 pieces 1/2" sockets	480	33	0.481	1828665	SL 1912
for 16 pieces 1/2" sockets	580	33	0.522	1761102	SL 1916

# VH 19 SPRING STEEL SOCKET RAIL 1/2"



- > For 14 1/2" sockets
- > Delivery without tools



↳ mm	kg	Code	No.
405	0.065	5162520	VH 19

## VDE 1990

>574



## VDE 1988 / VDE 1989 T

>574





## 20 (3/4") square drive

20 20

## Sets 20 (3/4") METRIC

20 3/4

32 EM / D 32 EM  
SOCKET SET 3/4"

14 pieces

- > With forged, tempered hexagon (no.32) or UD profile sockets (no. D 32), hand-operated
- > With accessories made from GEDORE vanadium steel 31CrV3
- > Set U-2 with fine toothed, dial change ratchet
- > Set Z-94 with ratchet with square coupler
- > In GEDORE blue sheet steel case
- > Dimensions: 525 x 203 x 73 mm

20  
3/4  
mm

Ratchet	Sockets	Accessories	mm	Code	No.
⊗ Z-94 <b>3293 Z-94</b>	○ 32 22 24 27 30 32 36 38 41 46 50	⚙️ <b>3287</b> ⚙️ <b>3290-8 -16</b>	11.4	6280180	32 EMZ
⊗ U-2 <b>3293 U-2</b>	○ 32 22 24 27 30 32 36 38 41 46 50	⚙️ <b>3287</b> ⚙️ <b>3290-8 -16</b>	11.6	6280340	32 EMU-2
⊗ Z-94 <b>3293 Z-94</b>	⊗ D 32 22 24 27 30 32 36 38 41 46 50	⚙️ <b>3287</b> ⚙️ <b>3290-8 -16</b>	11.2	6280260	D 32 EMZ
⊗ U-2 <b>3293 U-2</b>	⊗ D 32 22 24 27 30 32 36 38 41 46 50	⚙️ <b>3287</b> ⚙️ <b>3290-8 -16</b>	11.1	6280420	D 32 EMU-2

32 FM / D 32 FM  
SOCKET SET 3/4"

16 pieces

- > With forged, tempered hexagon, bi-hexagon (no.32) or UD profile sockets (no. D 32), hand-operated
- > With accessories made from GEDORE vanadium steel 31CrV3
- > Set U-2 with fine toothed, dial change ratchet
- > Set Z-94 with ratchet with square coupler
- > In GEDORE blue sheet steel case
- > Dimensions: 555 x 230 x 80 mm

20  
3/4  
mm

Ratchet	Sockets	Accessories	mm	Code	No.
⊗ Z-94 <b>3293 Z-94</b>	○ 32 22 24 27 30 32 36 38 41 46 50 55 60	⚙️ <b>3287</b> ⚙️ <b>3290-8 -16</b>	15.6	6280930	32 FMZ
⊗ U-2 <b>3293 U-2</b>	○ 32 22 24 27 30 32 36 38 41 46 50 55 60	⚙️ <b>3287</b> ⚙️ <b>3290-8 -16</b>	15.8	6281150	32 FMU-2
⊗ Z-94 <b>3293 Z-94</b>	⊗ D 32 22 24 27 30 32 36 38 41 46 50 55 60	⚙️ <b>3287</b> ⚙️ <b>3290-8 -16</b>	15.1	6281070	D 32 FMZ
⊗ U-2 <b>3293 U-2</b>	⊗ D 32 22 24 27 30 32 36 38 41 46 50 55 60	⚙️ <b>3287</b> ⚙️ <b>3290-8 -16</b>	15.2	6281230	D 32 FMU-2

## Sets 20 (3/4") INCH

### D 32 EA SOCKET SET 3/4"

14 pieces

- > With forged, tempered bi-hexagon UD profile sockets, hand-operated
- > With accessories made from GEDORE vanadium steel 31CrV3
- > Set U-2 with fine toothed, dial change ratchet
- > Set Z-94 with ratchet with square coupler
- > In GEDORE blue sheet steel case
- > Dimensions: 525 x 203 x 73 mm



20  
3/4"  
 "AF"

Ratchet	Sockets	Accessories	kg	Code	No.
Z-94 <b>3293 Z-94</b>	<b>D 32</b> 15/16 1.1/16 1.1/8 1.1/4 1.5/16 1.3/8 1.1/2 1.5/8 1.7/8 2"	<b>3287</b> <b>3290-8 -16</b>	11.3	6280500	D 32 EAZ
U-2 <b>3293 U-2</b>	<b>D 32</b> 15/16 1.1/16 1.1/8 1.1/4 1.5/16 1.3/8 1.1/2 1.5/8 1.7/8 2"	<b>3287</b> <b>3290-8 -16</b>	11.3	6280690	D 32 EAU-2

### D 32 EMAU-2 SOCKET SET 3/4"

25 pieces

- > With forged, tempered bi-hexagon UD profile sockets, hand-operated
- > With accessories made from GEDORE vanadium steel 31CrV3
- > With fine toothed, dial change ratchet
- > In GEDORE blue sheet steel case
- > Dimensions: 660 x 230 x 80 mm



20  
3/4"  
 mm  
 "AF"

Ratchet	Sockets	Accessories	kg	Code	No.
U-2 <b>3293 U-2</b>	<b>D 32</b> 22 24 27 30 32 36 41 46 50 <b>D 32</b> 7/8 15/16 1" 1.1/16 1.1/8 1.1/4 1.5/16 1.3/8 1.1/2 1.11/16 1.7/8 2"	<b>3287</b> <b>3290-8 -16</b>	18.2	6281310	D 32 EMAU-2

## ... CUSTOMISED FOR YOU!

#### Individual – precise – customised – flexible – right on!

- > From non-standard sizes, special surface treatment (colour and/or finish), customised tool modules through to special electronic product programming and establishing/implementing individual maintenance intervals (calibration/services) - and a lot more besides.

- > **WE** develop special tools, customised tools and/or quality forgings **for YOU**.
- > Your problems are our assignments.
- > Simply contact us !



## Ratchets 20 (3/4")

### 3293 U-10 REVERSIBLE RATCHET 3/4"

- > Particularly for the demanding use experienced in industry and with utility vehicles
- > Acc. to DIN 3122, ISO 3315
- > With recessed lever change, locks in middle position
- > Return angle 11.25 degrees

- > Push-fit tube handle
- > For hand-operated sockets and accessories with square drive as per DIN 3120 - D 20, ISO 1174 with locking pin
- > GEDORE vanadium steel 31CrV3, chrome-plated



"	mm	°	mm	mm	kg	Code	No.
3/4	20	11,25	620	57.5	2.630	6277980	3293 U-10

### 3293 U-2 REVERSIBLE RATCHET 3/4"

- > Especially for working in confined spaces
- > Acc. to DIN 3122, ISO 3315
- > With disc change, fine-toothed and robust
- > Return angle 7.2 degrees

- > For hand-operated sockets and accessories with square drive as per DIN 3120 - D 20, ISO 1174 with locking pin
- > GEDORE vanadium steel 31CrV3, chrome-plated

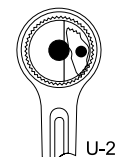

"	mm	°	mm	mm	kg	Code	No.
3/4	20	7,2	510	60	1.435	6278600	3293 U-2

### 3293 U-3 REVERSIBLE RATCHET 3/4"

- > Especially for working in confined spaces, as in the automotive business and with utility vehicles
- > Acc. to DIN 3122, ISO 3315
- > With non-slip metal disc change, fine-toothed (72 teeth) and robust
- > Return angle 5 degrees
- > Push-fit tube handle

- > For hand-operated sockets and accessories with square drive as per DIN 3120 - D 20, ISO 1174, with locking pin
- > GEDORE vanadium steel 31CrV3, chrome-plated

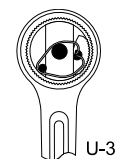

"	mm	°	mm	mm	kg	Code	No.
3/4	20	5	620	62.5	2.610	6278790	3293 U-3

### 3293 Z-94 RATCHET HANDLE WITH COUPLER 3/4"

- > Used throughout industry and the automotive world
- > Acc. to DIN 3122, ISO 3315
- > With square coupler, medium-fine toothed, extremely rugged
- > Return angle 10 degrees

- > For hand-operated sockets and accessories with square drive as per DIN 3120 - D 20, ISO 1174 with locking pin
- > GEDORE vanadium steel 31CrV3, chrome-plated

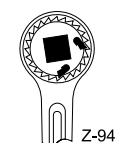

"	mm	°	mm	mm	kg	Code	No.
3/4	20	10	510	31	1.301	6278950	3293 Z-94

## Sockets 20 (3/4")

### 32 SOCKET 3/4"

hexagon UD profile

- > Acc. to DIN 3124, ISO 2725-1
- > Square drive as per DIN 3120 - D 20, ISO 1174, with locking pin
- > Hand-operated, knurled grip
- > GEDORE vanadium steel 31CrV3, chrome-plated
- \* not standardised

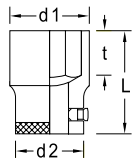

Ø mm	L	d <sub>1</sub>	d <sub>2</sub>	t		Code	No.	
18	*	51.5	28.3	36.0	19.0	0.219	6269880	32 18
19	*	51.5	29.6	36.0	19.0	0.225	6270110	32 19
21		51.5	32.0	36.0	19.0	0.228	6269960	32 21
22		51.5	33.3	36.0	19.0	0.232	6270380	32 22
24		51.5	35.8	38.0	19.5	0.267	6270460	32 24
27		54.5	39.6	36.0	24.0	0.271	6270540	32 27
29	*	54.5	42.0	36.0	23.5	0.281	6270620	32 29
30		57.5	43.3	38.0	26.0	0.331	6270700	32 30
32		57.5	45.8	38.0	27.0	0.345	6270890	32 32
33	*	57.5	47.0	40.0	26.5	0.392	6270030	32 33
34		57.5	48.3	40.0	26.5	0.404	6279410	32 34

Ø mm	L	d <sub>1</sub>	d <sub>2</sub>	t		Code	No.	
36		59.5	50.8	40.0	28.0	0.448	6270970	32 36
38	*	59.5	53.3	40.5	28.0	0.476	6271000	32 38
41		62.5	57.1	44.0	30.5	0.593	6271190	32 41
46		65.5	63.3	44.0	32.5	0.700	6271270	32 46
50		68.5	68.3	48.0	34.5	0.848	6271350	32 50
55		68.5	74.6	53.0	33.0	1.008	6271430	32 55
60		68.5	80.8	53.0	33.0	1.143	6271510	32 60

### D 32 (MM) SOCKET 3/4"

bi-hexagon UD profile

- > Acc. to DIN 3124, ISO 2725-1
- > Square drive as per DIN 3120 - D 20, ISO 1174, with locking pin
- > Hand-operated, knurled grip
- > GEDORE vanadium steel 31CrV3, chrome-plated
- \* not standardised

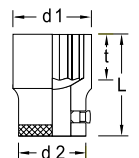

Ø mm	L	d <sub>1</sub>	d <sub>2</sub>	t		Code	No.	
19	*	51.5	29.6	36.0	19.0	0.221	6272160	D 32 19
21		51.5	32.0	36.0	19.0	0.223	6289800	D 32 21
22		51.5	33.3	36.0	19.0	0.227	6272240	D 32 22
24		51.5	35.8	38.0	19.5	0.257	6272320	D 32 24
27		54.5	39.6	36.0	24.0	0.255	6272400	D 32 27
29	*	54.5	42.0	36.0	23.5	0.272	6272590	D 32 29
30		57.5	43.3	38.0	26.0	0.319	6272670	D 32 30
32		57.5	45.8	38.0	27.0	0.332	6272750	D 32 32
33	*	57.5	47.0	40.0	26.5	0.358	6277040	D 32 33
36		59.5	50.8	40.0	28.0	0.418	6272830	D 32 36

Ø mm	L	d <sub>1</sub>	d <sub>2</sub>	t		Code	No.	
38	*	59.5	53.3	40.5	28.0	0.441	6272910	D 32 38
41		62.5	57.1	44.0	30.5	0.558	6273050	D 32 41
46		65.5	63.3	44.0	32.5	0.641	6273130	D 32 46
50		68.5	68.3	48.0	34.5	0.800	6273210	D 32 50
55		68.5	74.6	53.0	33.0	0.961	6273480	D 32 55
60		68.5	80.8	53.0	33.0	1.052	6273560	D 32 60

# D 32 (AF) SOCKET 3/4"

bi-hexagon UD profile

- > Square drive as per DIN 3120 - D 20, ISO 1174, with locking pin
- > Hand-operated, knurled grip
- > GEDORE vanadium steel 31CrV3, chrome-plated

AF	L	d <sub>1</sub>	d <sub>2</sub>	t	kg	Code	No.
7/8	51.5	33.6	36.0	19.0	0.227	6274020	D 32 7/8AF
15/16	51.5	35.6	38.0	19.5	0.262	6274100	D 32 15/16AF
1	51.5	37.6	36.0	22.0	0.229	6274290	D 32 1AF
1.1/16	54.5	39.6	36.0	24.0	0.256	6274370	D 32 1.1/16AF
1.1/8	54.5	41.5	36.0	24.0	0.268	6274450	D 32 1.1/8AF
1.1/4	57.5	45.5	38.0	27.0	0.333	6274530	D 32 1.1/4AF
1.5/16	57.5	47.5	40.0	26.5	0.377	6274610	D 32 1.5/16AF
1.3/8	59.5	49.5	40.0	28.0	0.407	6274880	D 32 1.3/8AF

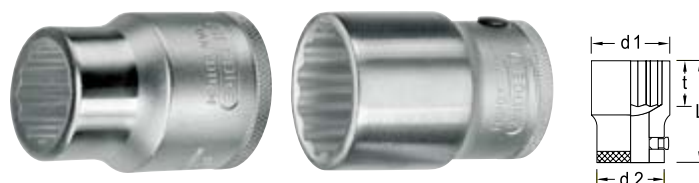

AF	L	d <sub>1</sub>	d <sub>2</sub>	t	kg	Code	No.
1.7/16	59.5	51.4	40.0	28.0	0.413	6274960	D 32 1.7/16AF
1.1/2	59.5	53.3	40.5	28.0	0.431	6275180	D 32 1.1/2AF
1.5/8	62.5	57.4	44.0	30.5	0.539	6275260	D 32 1.5/8AF
1.11/16	62.5	59.4	44.0	30.5	0.568	6275340	D 32 1.11/16AF
1.3/4	65.5	61.4	44.0	32.5	0.627	6275420	D 32 1.3/4AF
1.13/16	65.5	63.3	44.0	32.5	0.637	6275500	D 32 1.13/16AF
1.7/8	65.5	65.3	44.0	32.5	0.664	6275690	D 32 1.7/8AF
2	68.5	69.2	48.0	34.5	0.811	6275770	D 32 2AF

# IN 32 SCREWDRIVER BIT SOCKET 3/4"

for in-hex screws

- > Acc. to DIN 7422
- > Square drive as per DIN 3120 - D 20, ISO 1174, with locking pin
- > Hand-operated, knurled grip
- > Chrome-plated
- > With pressed-in pin in GEDORE vanadium special steel, manganese-phosphated

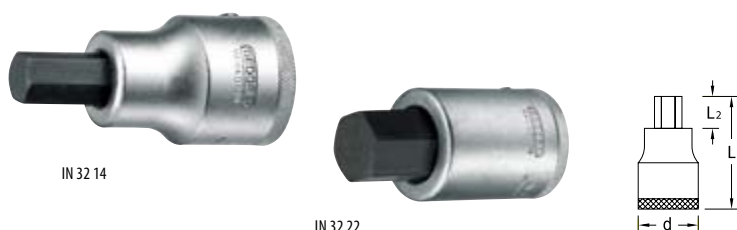

mm	L <sub>1</sub>	L <sub>2</sub>	d	kg	Code	No.
14	80	25.5	38	0.352	6275850	IN 32 14
17	80	25.5	38	0.394	6275930	IN 32 17

mm	L <sub>1</sub>	L <sub>2</sub>	d	kg	Code	No.
19	80	25.5	38	0.433	6276070	IN 32 19
22	80	25.5	38	0.482	6276150	IN 32 22

# IN 32 L SCREWDRIVER BIT SOCKET 3/4"

for in-hex screws, long pattern

- > Acc. to DIN 7422
- > Square drive as per DIN 3120 - D 20, ISO 1174, with locking pin
- > Hand-operated, knurled grip
- > Chrome-plated
- > With pressed-in pin in GEDORE vanadium special steel, manganese-phosphated



mm	L <sub>1</sub>	L <sub>2</sub>	d	kg	Code	No.
14	155	100	38	0.452	2003503	IN 32 L 14-155
17	155	100	38	0.540	1353705	IN 32 L 17-155
19	155	100	38	0.610	2003511	IN 32 L 19-155
22	155	100	38	0.730	2003538	IN 32 L 22-155

# ITX 32 SCREWDRIVER BIT SOCKET 3/4"

for recessed TORX® head screws

- > Square drive as per DIN 3120 - D 20, ISO 1174, with locking pin
- > Hand-operated, knurled grip
- > Chrome-plated
- > With pressed-in pin in GEDORE vanadium special steel, gun-metal finish
- > TORX® = reg. trademark of Acument Intellectual Properties, LLC. USA



	M	mm	L <sub>1</sub>	L <sub>2</sub>	d	kg	Code	No.
T60	M14	13,25	80	25.5	38	0.346	6271780	ITX 32 T60
T70	M16	15,55	80	25.5	38	0.383	6272080	ITX 32 T70
T80	M18	17,58	80	25.5	38	0.416	6273640	ITX 32 T80
T90	M20	19,95	80	25.5	38	0.455	6276230	ITX 32 T90
T100	M22	21,16	80	25.5	38	0.461	6276310	ITX 32 T100

## Accessories 20 (3/4")

### 3296 SWIVEL HANDLE 3/4"

- > Acc. to DIN 3122, ISO 3315
- > For hand-operated sockets with square drive as per DIN 3120, ISO 1174, with locking pin
- > GEDORE vanadium steel 31CrV3, chrome-plated



■ "	■	↳ mm	⚖ kg	Code	No.
3/4	20	547	1.965	6279250	3296

### 3287 SLIDING T BAR 3/4"

- > Acc. to DIN 3122, ISO 3315
- > For hand-operated sockets with square drive as per DIN 3120, ISO 1174, with locking pin
- > GEDORE vanadium steel 31CrV3, chrome-plated



■ "	■	↳ mm	⚖ kg	Code	No.
3/4	20	500	1.161	6278360	3287

### 3290 EXTENSION 3/4"

- > Acc. to DIN 3123, ISO 3316
- > For hand-operated sockets with square drive as per DIN 3120, ISO 1174, with locking pin
- > GEDORE vanadium steel 31CrV3, chrome-plated



3290-8



3290-16

■ "	■	↳ mm	⚖ kg	Code	No.	■ "	■	↳ mm	⚖ kg	Code	No.
3/4	20	200	0.574	6278440	3290-8	3/4	20	400	1.079	6278520	3290-16



## 3295 UNIVERSAL JOINT 3/4"

- > Acc. to DIN 3123, ISO 3316
- > For hand-operated sockets with square drive as per DIN 3120, ISO 1174, with locking pin
- > GEDORE vanadium steel 31CrV3, chrome-plated



□"	■	□"	□	↳ mm	⚖️	Code	No.
3/4	20	3/4	20	108	0.580	6279170	3295

## 3294 COUPLER 3/4"

- > Acc. to DIN 3122, ISO 3315
- > For hand-operated sockets with square drive as per DIN 3120, ISO 1174, with locking pin
- > Chrome-vanadium steel, chrome-plated



□"	■	↳ mm	⚖️	Code	No.
3/4	20	51.5	0.133	6279090	3294

## 3219 REDUCER 3/4" TO 1/2"

- > Acc. to DIN 3123, ISO 3316
- > For hand-operated sockets with square drive as per DIN 3120, ISO 1174, with locking pin
- > GEDORE vanadium steel 31CrV3, chrome-plated



□"	□	■"	■	↳ mm	⚖️	Code	No.
3/4	20	1/2	12.5	56	0.168	6278010	3219

## 3221 CONVERTOR 3/4" TO 1"

- > Acc. to DIN 3123, ISO 3316
- > For hand-operated sockets with square drive as per DIN 3120, ISO 1174, with locking pin
- > GEDORE vanadium steel 31CrV3, chrome-plated



□"	□	■"	■	↳ mm	⚖️	Code	No.
3/4	20	1	25	60	0.337	6278280	3221

### DVV-40ZRS

> 335



### DVI-20L / DVI-28L

> 339



## 25 (1") square drive

25 1" 25 1"

## Sets 25 (1") METRIC







25 1"

D 21 EMU-10  
SOCKET SET 1"

15 pieces

- > With forged, tempered UD profile sockets, hand-operated
- > With accessories made from GEDORE vanadium steel 31CrV3
- > With reversible lever change ratchet
- > In GEDORE blue sheet steel case
- > Dimensions: 765 x 289 x 105 mm

25  
1"  
mm

Ratchet	Sockets	Accessories		Code	No.
 U-10 K <b>2193 U-10 K</b>	 <b>D 21</b> 36 41 46 50 55 60 65 70 75 80	 <b>2190-8</b> -16  <b>2187 G</b>  <b>2187 K</b>	31.4	6181600	D 21 EMU-10







## Sets 25 (1") INCH

D 21 EAU-10  
SOCKET SET 1"

15 pieces

- > With forged, tempered UD profile sockets, hand-operated
- > With accessories made from GEDORE vanadium steel 31CrV3
- > With reversible lever change ratchet
- > In GEDORE blue sheet steel case
- > Dimensions: 765 x 289 x 105 mm

25  
1"  
"AF

Ratchet	Sockets	Accessories		Code	No.
 U-10 K <b>2193 U-10 K</b>	 <b>D 21</b> 1.1/2 1.5/8 1.7/8 2 2.1/16 2.1/4 2.3/8 2.9/16 2.3/4 3"	 <b>2190-8</b> -16  <b>2187 G</b>  <b>2187 K</b>	34.9	6181790	D 21 EAU-10

## Ratchets 25 (1")

2193 U-10  
REVERSIBLE RATCHET 1"

- › Particularly for the demanding use experienced in industry and with utility vehicles
- › Acc. to DIN 3122, ISO 3315
- › With recessed lever change, locks in middle position
- › Return angle 11.25 degrees

- › Push-fit bar handle no. 2187 G
- › For hand-operated sockets and accessories with square drive as per DIN 3120 - D 25, ISO 1174 with locking pin
- › GEDORE vanadium steel 31CrV3, chrome-plated



Execution	1"	25	°	l mm	mm	kg	Code	No.
<b>complete</b>	1	25	11,25	810	61.5	5.210	6180550	2193 U-10
<b>head only</b>	1	25		184	61.5	1.980	6196120	2193 U-10 K
<b>tommy bar</b>				700		3.275	6195900	2187 G

2193 U-3  
REVERSIBLE RATCHET 1"

- › Especially for working in confined spaces, as with utility vehicles
- › Acc. to DIN 3122, ISO 3315
- › With non-slip metal disc change, fine-toothed (72 teeth) and robust
- › Return angle 5 degrees

- › Push-fit tube handle
- › For hand-operated sockets and accessories with square drive as per DIN 3120 - D 25, ISO 1174, with locking pin
- › GEDORE vanadium steel 31CrV3, chrome-plated

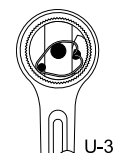

Execution	1"	25	°	l mm	mm	kg	Code	No.
<b>complete</b>	1	25	5	720	76	4.160	6180630	2193 U-3
<b>head only</b>	1	25				2.000	1637487	2193 U-3 K
<b>tube</b>						2.175	1382500	2193 Z/17

2193 Z-94  
RATCHET HANDLE WITH COUPLER 1"

- › Used throughout industry and the automotive world
- › Acc. to DIN 3122, ISO 3315
- › With square coupler, medium-fine toothed, extremely rugged
- › Return angle 9 degrees

- › Push-fit tube handle
- › For hand-operated sockets and accessories with square drive as per DIN 3120 - D 25, ISO 1174 with locking pin
- › GEDORE vanadium steel 31CrV3, chrome-plated

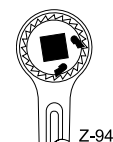

Execution	1"	25	°	l mm	mm	kg	Code	No.
<b>complete</b>	1	25	9	720	41	4.115	6181520	2193 Z-94
<b>head only</b>	1	25				1.175	1493779	2193 Z K
<b>tube</b>						2.175	1382500	2193 Z/17

Sockets 25 (1")

D 21 (MM)  
SOCKET 1"

25  
1"

bi-hexagon UD profile

- > Acc. to DIN 3124, ISO 2725-1
- > Square drive as per DIN 3120 - D 25, ISO 1174, with locking pin
- > Hand-operated, knurled grip
- > GEDORE vanadium steel 31CrV3, chrome-plated
- \* not standardised

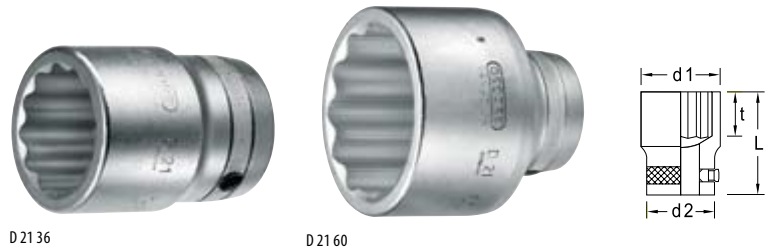

Ø mm	L	d <sub>1</sub>	d <sub>2</sub>	t		Code	No.
36	* 70.0	53.9	48.0	30.0	0.600	6174900	D 21 36
41	70.0	60.1	50.0	30.5	0.688	6175040	D 21 41
46	75.0	66.4	50.0	33.5	0.842	6175120	D 21 46
50	75.0	71.4	50.0	35.0	0.908	6175200	D 21 50
55	80.0	77.6	50.0	37.5	1.129	6175390	D 21 55

Ø mm	L	d <sub>1</sub>	d <sub>2</sub>	t		Code	No.
60	85.0	83.9	50.0	41.0	1.376	6175470	D 21 60
65	88.0	90.1	59.5	44.5	1.700	6175550	D 21 65
70	92.0	96.4	59.5	48.0	1.984	6175630	D 21 70
75	95.0	102.6	59.5	51.0	2.225	6175710	D 21 75
80	97.0	108.9	59.5	54.0	2.454	6175980	D 21 80

D 21 (AF)  
SOCKET 1"

25  
1"

bi-hexagon

- > Square drive as per DIN 3120 - D 25, ISO 1174, with locking pin
- > Hand-operated, knurled grip
- > GEDORE vanadium steel 31CrV3, chrome-plated



Ø"AF	L	d <sub>1</sub>	d <sub>2</sub>	t		Code	No.
1.1/2	70.0	56.5	48.0	30.0	0.649	6176520	D 21 1.1/2AF
1.5/8	70.0	60.1	50.0	30.5	0.701	6176600	D 21 1.5/8AF
1.13/16	75.0	66.4	50.0	33.5	0.835	6176870	D 21 1.13/16AF
1.7/8	75.0	68.4	50.0	33.5	0.890	6176950	D 21 1.7/8AF
2	75.0	72.4	50.0	35.0	0.944	6177090	D 21 2AF
2.1/16	75.0	74.0	50.0	35.0	0.987	6177170	D 21 2.1/16AF
2.3/16	80.0	78.3	50.0	37.5	1.181	6177250	D 21 2.3/16AF
2.1/4	80.0	80.3	50.0	37.5	1.230	6177330	D 21 2.1/4AF
2.3/8	85.0	83.9	50.0	41.0	1.398	6177410	D 21 2.3/8AF

Ø"AF	L	d <sub>1</sub>	d <sub>2</sub>	t		Code	No.
2.7/16	85.0	86.2	50.0	41.0	1.544	6177680	D 21 2.7/16AF
2.9/16	88.0	90.1	59.5	44.5	1.788	6177760	D 21 2.9/16AF
2.5/8	88.0	92.2	59.5	44.5	1.813	6177840	D 21 2.5/8AF
2.3/4	92.0	96.4	59.5	48.0	2.065	6177920	D 21 2.3/4AF
2.13/16	92.0	98.2	59.5	48.0	2.140	6178060	D 21 2.13/16AF
2.15/16	95.0	102.6	59.5	51.0	2.307	6178140	D 21 2.15/16AF
3	95.0	104.1	59.5	51.0	2.349	6178220	D 21 3AF
3.1/8	97.0	108.9	59.5	54.0	2.556	6178300	D 21 3.1/8AF

IN 21  
SCREWDRIVER BIT SOCKET 1"

25  
1"

for in-hex screws

- > Acc. to DIN 7422
- > Square drive as per DIN 3120 - D 25, ISO 1174, with locking pin
- > Hand-operated, knurled grip
- > Chrome-plated
- > With pressed-in pin in GEDORE vanadium special steel, manganese-phosphated
- \* not standardised



● mm	L <sub>1</sub>	L <sub>2</sub>	d		Code	No.
17	90	25.5	48	0.613	6181010	IN 21 17
19	90	25.5	48	0.676	6181280	IN 21 19
22	90	25.5	48	0.733	6181360	IN 21 22
24	90	25.5	48	0.784	6181440	IN 21 24
27	* 90	25.5	48	0.856	6200680	IN 21 27

K 21

>246



## Accessories 25 (1")

2187  
SLIDING T BAR 1"

- > Acc. to DIN 3122, ISO 3315
- > For hand-operated sockets with square drive as per DIN 3120, ISO 1174, with locking pin
- > GEDORE vanadium steel 31CrV3, chrome-plated

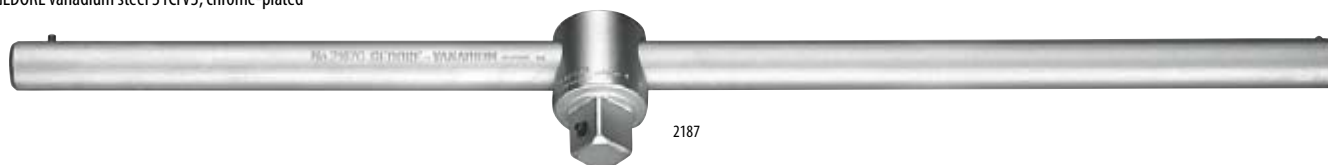

Execution	■"	■	↳ mm ↲	⚖	Code	No.
<b>complete</b>	1	25	700	3.955	6180120	2187
<b>drive piece</b>	1	25	80	0.680	6196040	2187 K
<b>tommy bar</b>			700	3.275	6195900	2187 G

2190  
EXTENSION 1"

- > Acc. to DIN 3123, ISO 3316
- > For hand-operated sockets with square drive as per DIN 3120, ISO 1174, with locking pin
- > GEDORE vanadium steel 31CrV3, chrome-plated

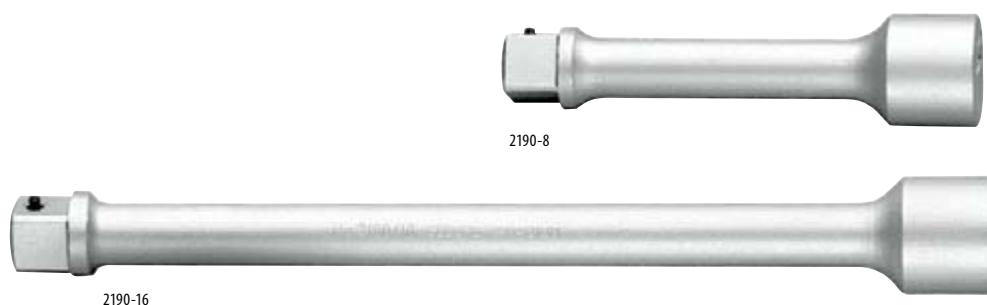

■"	■	↳ mm ↲	⚖	Code	No.
1	25	200	1.182	6180200	2190-8
1	25	400	2.144	6180390	2190-16

2194  
COUPLER 1"

- > Acc. to DIN 3122, ISO 3315
- > For hand-operated sockets with square drive as per DIN 3120, ISO 1174, with locking pin
- > GEDORE vanadium steel 31CrV3, chrome-plated



■"	■	↳ mm ↲	⚖	Code	No.
1	25	67.5	0.321	6180710	2194

2132  
REDUCER 1" TO 3/4"

- > Acc. to DIN 3123, ISO 3316
- > For hand-operated sockets with square drive as per DIN 3120, ISO 1174, with locking pin
- > GEDORE vanadium steel 31CrV3, chrome-plated

2195  
UNIVERSAL JOINT 1"

- > For hand-operated sockets with square drive as per DIN 3120, ISO 1174, with locking pin
- > GEDORE vanadium steel 31CrV3, chrome-plated



■"	■	□"	□	↳ mm ↲	⚖	Code	No.	□"	□	■"	■	↳ mm ↲	⚖	Code	No.
1	25	1	25	140	1.482	6180980	2195	1	25	3/4	20	75	0.504	6180040	2132

## Friction Type Ratchets

### 31 KR FRICTION TYPE RATCHET

with ring UD profile or bi-hexagon

- > Friction spanner (31 K) with exchangeable UD profile or bi-hexagon insert rings (31 R)
- > Hexagon rings are available on request
- > Especially in steel construction and scaffolding
- > Flat shaft up to 30", push-fit tube handle from 35"

- > GEDORE vanadium steel 31CrV3, manganese-phosphated
- > Explanation of the article number: 31 KR 16-32 = ratchet 31 K 16" and insert ring 31 R 32 mm

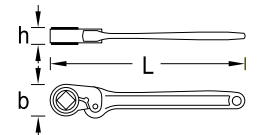

Ring	L	L"	h	b	kg	Code	No.
8	150	6	11.5	23.0	0.093	6253020	31 KR 6-8
10	150	6	11.5	23.0	0.088	6253290	31 KR 6-10
13	150	6	11.5	23.0	0.082	6253530	31 KR 6-13
15	205	8	15.5	31.2	0.220	6253880	31 KR 8-15
17	205	8	15.5	31.2	0.212	6254180	31 KR 8-17
19	255	10	17.5	38.0	0.346	6254340	31 KR 10-19
21	255	10	17.5	38.0	0.336	6254500	31 KR 10-21
22	255	10	17.5	38.0	0.330	6254690	31 KR 10-22
24	305	12	18.5	44.6	0.497	6254850	31 KR 12-24
26	305	12	18.5	44.6	0.482	6255070	31 KR 12-26
27	305	12	18.5	44.6	0.474	6255150	31 KR 12-27
28	305	12	18.5	44.6	0.466	6255230	31 KR 12-28
30	400	16	19.5	51.6	0.709	6255580	31 KR 16-30

Ring	L	L"	h	b	kg	Code	No.
32	400	16	19.5	51.6	0.684	6255740	31 KR 16-32
36	500	20	21.5	63.6	1.162	6256120	31 KR 20-36
41	500	20	21.5	63.6	1.098	6256470	31 KR 20-41
46	635	25	31.5	78.1	2.302	6256550	31 KR 25-46
50	635	25	31.5	78.1	2.213	6256630	31 KR 25-50
55	760	30	33.5	92.0	3.011	6256710	31 KR 30-55
60	760	30	33.5	92.0	2.879	6256980	31 KR 30-60
65	940	35	36.5	105.0	7.204	6257010	31 KR 35-65
70	940	35	36.5	105.0	7.023	6257280	31 KR 35-70
75	960	40	39.5	118.0	7.643	6257360	31 KR 40-75
80	960	40	39.5	118.0	7.392	6257440	31 KR 40-80

### 31 KVR FRICTION TYPE RATCHET

with square ring

- > Friction spanner (31 K) with exchangeable square insert rings (31 VR)
- > Especially in steel construction and scaffolding

- > GEDORE vanadium steel 31CrV3, manganese phosphated
- > Explanation of the article number: 31 KVR 8-12 = ratchet 31 K 8" and insert ring 31 VR 12 mm

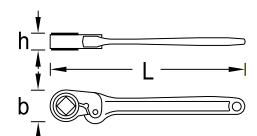

Ring	L	L"	h	b	kg	Code	No.
8	150	6	11.5	23.0	0.091	6266000	31 KVR 6-8
9	150	6	11.5	23.0	0.089	6266190	31 KVR 6-9
10	150	6	11.5	23.0	0.087	6266270	31 KVR 6-10
12	205	8	15.5	31.2	0.228	6266430	31 KVR 8-12

Ring	L	L"	h	b	kg	Code	No.
14	205	8	15.5	31.2	0.221	6266780	31 KVR 8-14
17	255	10	17.5	38.0	0.353	6267080	31 KVR 10-17
19	255	10	17.5	38.0	0.346	6267240	31 KVR 10-19



# 31 K

## FRICION RATCHET HANDLE WITHOUT INSERT RING

- > Friction spanner for insert rings 31 R and 31 VR
- > Especially in steel construction and scaffolding
- > GEDORE vanadium steel 31CrV3, manganese-phosphated



Ring	Ring	L	L"	Head Ø	Weight	Code	No.
8-13	8-11	150	6	20	0.070	6243060	31 K 6
14-17	12-14	205	8	28	0.176	6243140	31 K 8
18-23	17-19	255	10	34	0.277	6243220	31 K 10
24-28		305	12	40	0.406	6243300	31 K 12
30-32		400	16	46	0.600	6243490	31 K 16
34-41		500	20	57	0.961	6243570	31 K 20

Ring	Ring	L	L"	Head Ø	Weight	Code	No.
46-50		635	25	70	1.880	6243650	31 K 25
55-60		760	30	82	2.435	6243730	31 K 30
65-70		940	35	96	6.305	6243810	31 K 35
75-80		960	40	108	6.480	6244030	31 K 40

# 31 R

## INSERT RING FOR FRICTION RATCHET

UD profile or bi-hexagon

- > GEDORE vanadium steel 31CrV3, manganese-phosphated



Ring	Ø	Length	Weight	Code	No.
8	19.7	6	0.021	6245000	31 R 8
10	19.7	6	0.018	6245270	31 R 10
13	19.7	6	0.011	6245510	31 R 13
14	27.6	8	0.047	6245780	31 R 14
15	27.6	8	0.044	6245860	31 R 15
16	27.6	8	0.040	6245940	31 R 16
17	27.6	8	0.036	6246080	31 R 17
18	33.6	10	0.075	6246160	31 R 18
19	33.6	10	0.069	6246240	31 R 19
21	33.6	10	0.059	6246400	31 R 21
22	33.6	10	0.053	6246590	31 R 22
24	39.6	12	0.091	6246750	31 R 24
26	39.6	12	0.076	6246910	31 R 26
27	39.6	12	0.069	6247050	31 R 27

Ring	Ø	Length	Weight	Code	No.
28	39.6	12	0.061	6247130	31 R 28
30	45.6	16	0.109	6247480	31 R 30
32	45.6	16	0.084	6247640	31 R 32
36	56.6	20	0.201	6248020	31 R 36
41	56.6	20	0.137	6248370	31 R 41
46	70.0	25	0.422	6248450	31 R 46
50	70.0	25	0.333	6248530	31 R 50
55	82.0	30	0.576	6248610	31 R 55
60	82.0	30	0.444	6248880	31 R 60
65	96.0	35	0.899	6248960	31 R 65
70	96.0	35	0.718	6249180	31 R 70
75	108.0	40	1.163	6249260	31 R 75
80	108.0	40	0.912	6249340	31 R 80

# 31 VR

## INSERT RING FOR FRICTION RATCHET

square

- > GEDORE vanadium steel 31CrV3, manganese-phosphated



Ring	Ø	Length	Weight	Code	No.
8	19.7	6	0.021	6261200	31 VR 8
9	19.7	6	0.018	6261390	31 VR 9
10	19.7	6	0.017	6261470	31 VR 10
12	27.6	8	0.052	6261630	31 VR 12

Ring	Ø	Length	Weight	Code	No.
14	27.6	8	0.045	6261980	31 VR 14
17	33.6	10	0.076	6262360	31 VR 17
19	33.6	10	0.069	6262520	31 VR 19

# 29 CONSTRUCTION RATCHET

bi-hexagon

> Reversible ratchet with two different size heads, bi-hexagon and "rat-tail" handle

> Especially in steel construction and scaffolding

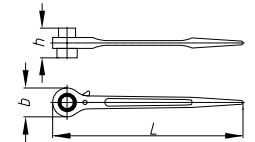

Ø	L	h	b	kg	Code	No.
<b>17 x 19</b>	315	49.0	42.0	0.463	1648934	29 17x19
<b>19 x 22</b>	315	49.5	42.0	0.448	1382853	29 19x22
<b>19 x 24</b>	365	56.0	51.5	0.757	1648926	29 19x24

Ø	L	h	b	kg	Code	No.
<b>24 x 30</b>	402	63.0	61.0	1.378	6262790	29 24x30
<b>27 x 32</b>	402	63.0	61.0	1.278	6262950	29 27x32
<b>36 x 41</b>	495	74.0	76.0	1.377	6263170	29 36x41

# 41 - 41 B REVERSIBLE LEVER CHANGE RATCHET

- > With permanently fixed UD profile insert
- > GEDORE vanadium steel 31CrV3, chrome-plated

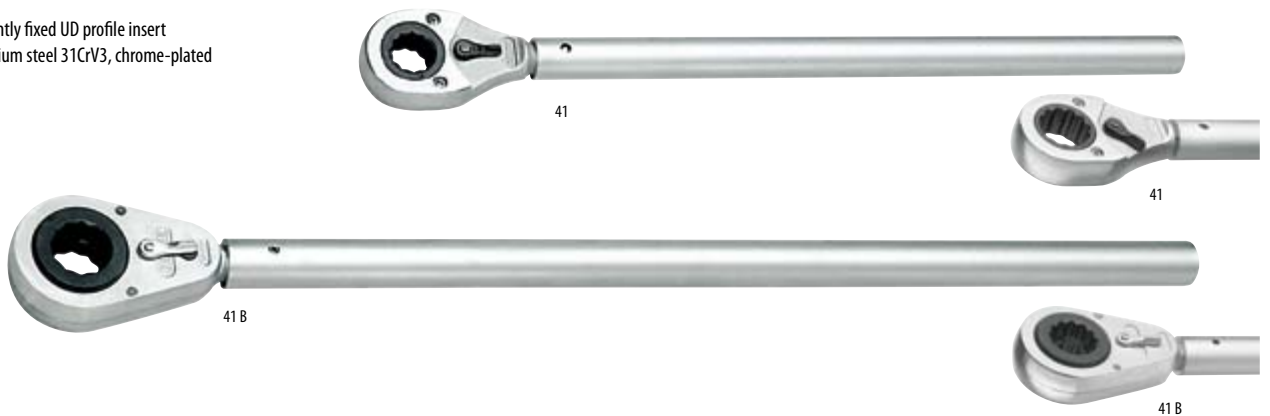

Ø	∠°	mm	mm	kg	Code	No.
<b>22</b>	11,25	27.9	620	2.455	6338790	41 22
<b>24</b>	11,25	27.9	620	2.430	6338870	41 24
<b>27</b>	11,25	27.9	620	2.410	6338950	41 27
<b>28</b>	11,25	27.9	620	2.393	6330030	41 28
<b>30</b>	11,25	27.9	620	2.365	6339170	41 30

Ø	∠°	mm	mm	kg	Code	No.
<b>32</b>	11,25	27.9	620	2.330	6339250	41 32
<b>36</b>	15,00	43.0	910	5.025	6338360	41 B 36
<b>41</b>	15,00	43.0	910	4.895	6338440	41 B 41
<b>46</b>	15,00	43.0	910	4.725	6338520	41 B 46

# 41 V - 41 BV REVERSIBLE LEVER CHANGE RATCHET

- > With permanently fixed square insert
- > Especially in steel construction and scaffolding
- > GEDORE vanadium steel 31CrV3, chrome-plated



Ø	∠°	mm	mm	kg	Code	No.
<b>19</b>	11,25	27.9	620	2.475	6339410	41 V 19
<b>22</b>	11,25	27.9	620	2.450	6339680	41 V 22
<b>24</b>	11,25	27.9	620	2.420	6339760	41 V 24
<b>27</b>	11,25	27.9	620	2.385	6339840	41 V 27

Ø	∠°	mm	mm	kg	Code	No.
<b>30</b>	15,00	43.0	910	5.115	6338600	41 BV 30
<b>32</b>	15,00	43.0	910	5.075	6339330	41 BV 32
<b>36</b>	15,00	43.0	910	4.970	6339920	41 BV 36

## Impact Tools

### 6.3 (1/4") square drive

## K 20 (MM) IMPACT SOCKET 1/4"

hexagon

- > Acc. to DIN 3129, ISO 2725-2
  - > Machine-operated, suitable for all standard electric and air tools
  - > Square drive as per DIN 3121 - G 6.3, ISO 1174
  - > GEDORE special steel, gun-metal finish
- \* not standardised

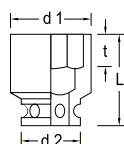

Ø mm	L	d <sub>1</sub>	d <sub>2</sub>	t	recommended accessories	⚖️	Code	No.
5.5	23	9.5	13	3	KB 2070, KB 2075	0.016	6198090	K 20 5,5
6.0	23	10.0	13	3	KB 2070, KB 2075	0.016	6198170	K 20 6
7.0	23	11.3	13	3	KB 2070, KB 2075	0.016	6198250	K 20 7
8.0	23	12.5	13	4	KB 2070, KB 2075	0.016	6198330	K 20 8
9.0	23	13.8	13	4	KB 2070, KB 2075	0.017	6198410	K 20 9
10.0	23	15.0	13	5	KB 2070, KB 2075	0.018	6198680	K 20 10
11.0	23	16.3	13	5	KB 2070, KB 2075	0.020	6198760	K 20 11
12.0	23	17.0	13	6	KB 2070, KB 2075	0.023	6198840	K 20 12
13.0	23	18.8	13	6	KB 2070, KB 2075	0.024	6198920	K 20 13
14.0	25	20.0	13	7	* KB 2070, KB 2075	0.035	6199060	K 20 14
17.0	26	23.8	13	7	* KB 2070, KB 2075	0.037	6199140	K 20 17

## K 20 (AF) IMPACT SOCKET 1/4"

hexagon

- > Machine-operated, suitable for all standard electric and air tools
- > Square drive as per DIN 3121 - G 6.3, ISO 1174
- > GEDORE special steel, gun-metal finish

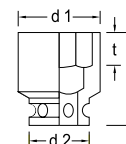

Ø AF	L	d <sub>1</sub>	d <sub>2</sub>	t	recommended accessories	⚖️	Code	No.
3/16	23	8.5	13	3	KB 2070, KB 2075	0.015	6199220	K 20 3/16AF
1/4	23	10.3	13	3	KB 2070, KB 2075	0.017	6199300	K 20 1/4AF
5/16	23	12.5	13	3	KB 2070, KB 2075	0.016	6199490	K 20 5/16AF
3/8	23	15.0	13	4	KB 2070, KB 2075	0.018	6199570	K 20 3/8AF
7/16	23	16.3	13	6	KB 2070, KB 2075	0.021	6199650	K 20 7/16AF

## KB 2090 EXTENSION 1/4"

for impact sockets

- > With square drive as per DIN 3121 - G 6.3, ISO 1174
- > GEDORE special steel, gun-metal finish



1/4"	6.3	↳ mm	⚖️	Code	No.
1/4	6.3	50	0.026	6201140	KB 2090-2

## KB 2070 - KB 2075 SAFETY RING AND SAFETY PIN

for impact sockets 1/4"



KB 2070



KB 2075

Description	Ø	↳ mm	⚖️	Code	No.
Safety ring d 9 mm	9.0	10	0.005	6200920	KB 2070
Safety pin d 1.5 mm	1.5	10	0.005	6201060	KB 2075

10 (3/8") square drive

# K 30

## IMPACT SOCKET 3/8"

hexagon

- > Acc. to DIN 3129, ISO 2725-2
- > Machine-operated, suitable for all standard electric and air tools
- > Square drive as per DIN 3121 - G 10, ISO 1174
- > GEDORE special steel, gun-metal finish
- \* not standardised



Ø mm	L	d <sub>1</sub>	d <sub>2</sub>	t	recommended accessories	⚖️ kg	Code	No.
6	30	11.0	19	3.0	* KB 3070 6-12, KB 3075 6-12	0.045	6251160	K 30 6
7	30	12.5	19	3.0	KB 3070 6-12, KB 3075 6-12	0.046	6251240	K 30 7
8	30	14.5	19	4.0	KB 3070 6-12, KB 3075 6-12	0.046	6251320	K 30 8
9	30	15.0	19	4.0	KB 3070 6-12, KB 3075 6-12	0.046	6251400	K 30 9
10	30	16.0	19	5.0	KB 3070 6-12, KB 3075 6-12	0.046	6251590	K 30 10
11	30	17.5	19	5.0	KB 3070 6-12, KB 3075 6-12	0.046	6251670	K 30 11
12	30	19.0	19	6.0	KB 3070 6-12, KB 3075 6-12	0.046	6251750	K 30 12
13	30	19.0	22	6.0	KB 3070 13-24, KB 3075 13-24	0.063	6251830	K 30 13
14	30	21.0	22	7.0	KB 3070 13-24, KB 3075 13-24	0.063	6251910	K 30 14
15	30	22.0	22	7.0	KB 3070 13-24, KB 3075 13-24	0.062	6252050	K 30 15
16	30	24.0	22	8.0	KB 3070 13-24, KB 3075 13-24	0.066	6252130	K 30 16
17	30	25.0	22	9.0	KB 3070 13-24, KB 3075 13-24	0.068	6252210	K 30 17
18	30	26.0	22	9.0	KB 3070 13-24, KB 3075 13-24	0.075	6252480	K 30 18
19	30	27.5	22	9.5	KB 3070 13-24, KB 3075 13-24	0.076	6252560	K 30 19
20	30	28.0	22	10.0	* KB 3070 13-24, KB 3075 13-24	0.084	6252640	K 30 20
21	30	30.0	22	11.0	* KB 3070 13-24, KB 3075 13-24	0.089	6252720	K 30 21
22	30	32.0	23	11.0	* KB 3070 13-24, KB 3075 13-24	0.093	6252800	K 30 22
23	30	32.0	23	13.0	* KB 3070 13-24, KB 3075 13-24	0.095	6252990	K 30 23
24	30	35.0	23	13.0	* KB 3070 13-24, KB 3075 13-24	0.105	6254420	K 30 24

# TX K 30

## IMPACT SOCKET 3/8"

for protruding TORX® head screws

- > Machine-operated, suitable for all standard electric and air tools
- > Square drive as per DIN 3121 - G 10, ISO 1174
- > GEDORE special steel, gun-metal finish
- > TORX® = reg. trademark of Acument Intellectual Properties, LLC. USA

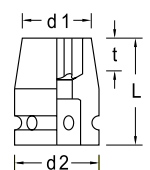

⊕	▨ mm	★ mm	L	d <sub>1</sub>	d <sub>2</sub>	t	recommended accessories	⚖️ kg	Code	No.
E5	M4	4,73	32	9.0	19	5	KB 3070 6-12, KB 3075 6-12	0.042	6265030	TX K 30 E5
E6	M5	5,74	32	10.0	19	5	KB 3070 6-12, KB 3075 6-12	0.044	6265110	TX K 30 E6
E7	M6	6,16	32	10.0	19	7	KB 3070 6-12, KB 3075 6-12	0.044	6265380	TX K 30 E7
E8	M6 - M7	7,52	32	10.5	19	8	KB 3070 6-12, KB 3075 6-12	0.048	6265460	TX K 30 E8
E10	M8	9,42	32	12.5	19	9	KB 3070 6-12, KB 3075 6-12	0.048	6265540	TX K 30 E10
E12	M10	11,17	32	15.0	19	10	KB 3070 6-12, KB 3075 6-12	0.047	6265620	TX K 30 E12
E14	M12	12,90	32	19.0	19	12	KB 3070 6-12, KB 3075 6-12	0.046	6265700	TX K 30 E14

## KB 3090 EXTENSION 3/8"

for impact sockets

- > With square drive as per DIN 3121 - G 10, ISO 1174
- > GEDORE special steel, manganese-phosphated



□"	■"	↳mm↳	⚖️	Code	No.
3/8	10	75	0.090	6261710	KB 3090-3
3/8	10	125	0.149	6262010	KB 3090-5
3/8	10	250	0.298	6262280	KB 3090-10

## KB 3095 UNIVERSAL JOINT 3/8"

for impact sockets

- > With square drive as per DIN 3121 - G 10, ISO 1174
- > GEDORE special steel, manganese-phosphated



□"	□	■"	■"	↳mm↳	⚖️	Code	No.
3/8	10	3/8	10	50	0.072	6262440	KB 3095

## KB 3019 CONVERTOR 3/8" TO 1/2"

for impact sockets

- > With square drive as per DIN 3121 - G 10, ISO 1174
- > GEDORE special steel, manganese-phosphated



□"	□	■"	■"	↳mm↳	⚖️	Code	No.
3/8	10	1/2	12.5	33	0.061	6263410	KB 3019

## KB 3020 REDUCER 3/8" TO 1/4"

for impact sockets

- > With square drive as per DIN 3121 - G 10, ISO 1174
- > GEDORE special steel, manganese-phosphated



□"	□	■"	■"	↳mm↳	⚖️	Code	No.
3/8	10	1/4	6.3	31	0.034	6263250	KB 3020

## KB 3070 - KB 3075 SAFETY RING AND SAFETY PIN

for impact sockets 3/8"



KB 3070



KB 3075

Description	∅	↳mm↳	⚖️	Code	No.
Safety ring d 14 mm	14.0		0.002	6260820	KB 3070 6-12
Safety ring d 15.5 mm	15.5		0.002	6260900	KB 3070 13-24
Safety pin d 2.5 mm	2.5	14	0.005	6261040	KB 3075 6-12
Safety pin d 2.5 mm	2.5	16	0.002	6261120	KB 3075 13-24

## 12.5 (1/2") square drive

### K 19-028 IMPACT SOCKET SET 1/2"

5 pieces

- > 5 impact sockets, machine-operated, suitable for all standard electric and air tools
- > Square drive as per DIN 3121 - G 12.5, ISO 1174
- > GEDORE special steel, gun-metal finish
- > In black plastic case



Sockets		Code	No.
○ 10 13 17 19 24	0.749	1646923	K 19-028

### K 19 LS-004 IMPACT SOCKET SET 1/2"

4 pieces

- > 4 impact sockets with protective sleeve, hexagon, long pattern
- > Machine-operated, suitable for all standard electric and air tools
- > Square drive as per DIN 3121 - G 12.5, ISO 1174
- > Thin-walled to protect the alloy wheels
- > GEDORE special steel, manganese-phosphated



Sockets		Code	No.
○ K 19 LS 17 19 21 22	0.980	2790831	K 19 LS-004

### K 19 (MM) IMPACT SOCKET 1/2"

hexagon

- > Acc. to DIN 3129, ISO 2725-2
- > Machine-operated, suitable for all standard electric and air tools
- > Square drive as per DIN 3121 - G 12.5, ISO 1174
- > GEDORE special steel, gun-metal finish
- \* not standardised

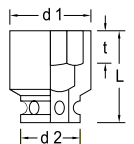

mm	L	d <sub>1</sub>	d <sub>2</sub>	t	recommended accessories		Code	No.
10	38	17.0	25	5.0	KB 1970 10-14, KB 1975 10-14	0.082	6160280	K 19 10
11	38	19.0	25	5.0	KB 1970 10-14, KB 1975 10-14	0.085	6160360	K 19 11
12	38	20.0	25	6.0	KB 1970 10-14, KB 1975 10-14	0.084	6160440	K 19 12
13	38	21.0	25	6.0	KB 1970 10-14, KB 1975 10-14	0.081	6160520	K 19 13
14	38	22.0	25	7.0	KB 1970 10-14, KB 1975 10-14	0.082	6160600	K 19 14
15	38	24.0	30	7.0	KB 1970 15-27, KB 1975 15-27	0.125	6161680	K 19 15
16	38	25.0	30	8.0	KB 1970 15-27, KB 1975 15-27	0.124	6160790	K 19 16
17	38	26.0	30	9.0	KB 1970 15-27, KB 1975 15-27	0.123	6160870	K 19 17
18	38	27.5	30	9.0	KB 1970 15-27, KB 1975 15-27	0.122	6160950	K 19 18
19	38	27.5	30	9.5	KB 1970 15-27, KB 1975 15-27	0.119	6161090	K 19 19
21	38	30.0	30	11.0	KB 1970 15-27, KB 1975 15-27	0.137	6161170	K 19 21
22	38	32.0	30	11.0	KB 1970 15-27, KB 1975 15-27	0.142	6161250	K 19 22
23	38	32.0	30	13.0	* KB 1970 15-27, KB 1975 15-27	0.148	6161330	K 19 23
24	45	35.0	30	13.0	KB 1970 15-27, KB 1975 15-27	0.154	6161410	K 19 24
27	50	38.0	30	13.0	KB 1970 15-27, KB 1975 15-27	0.180	6182680	K 19 27
30	50	41.0	30	16.0	* KB 1970 15-27, KB 1975 15-27	0.256	1560557	K 19 30
32	50	44.0	30	17.0	* KB 1970 15-27, KB 1975 15-27	0.286	1783742	K 19 32



## K 19 (AF) IMPACT SOCKET 1/2"

hexagon

- > Machine-operated, suitable for all standard electric and air tools
- > Square drive as per DIN 3121 - G 12.5, ISO 1174
- > GEDORE special steel, gun-metal finish

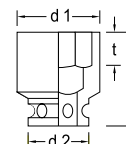

Ø"AF	L	d <sub>1</sub>	d <sub>2</sub>	t	recommended accessories	kg	Code	No.
<b>3/8</b>	38	16.0	25	4.0	KB 1970 10-14, KB 1975 10-14	0.079	6166990	K 19 3/8AF
<b>7/16</b>	38	18.0	25	6.0	KB 1970 10-14, KB 1975 10-14	0.079	6162300	K 19 7/16AF
<b>1/2</b>	38	20.0	25	6.0	KB 1970 10-14, KB 1975 10-14	0.078	6162650	K 19 1/2AF
<b>9/16</b>	38	22.0	25	7.0	KB 1970 10-14, KB 1975 10-14	0.080	6163030	K 19 9/16AF
<b>5/8</b>	38	25.0	25	8.0	KB 1970 15-27, KB 1975 15-27	0.121	6163460	K 19 5/8AF
<b>11/16</b>	38	25.0	25	9.0	KB 1970 15-27, KB 1975 15-27	0.121	6163700	K 19 11/16AF
<b>3/4</b>	38	27.5	30	9.5	KB 1970 15-27, KB 1975 15-27	0.115	6163970	K 19 3/4AF
<b>13/16</b>	38	30.0	30	11.0	KB 1970 15-27, KB 1975 15-27	0.131	6168420	K 19 13/16AF
<b>7/8</b>	38	32.0	30	13.0	KB 1970 15-27, KB 1975 15-27	0.141	6169820	K 19 7/8AF
<b>15/16</b>	38	35.0	30	13.0	KB 1970 15-27, KB 1975 15-27	0.156	6164190	K 19 15/16AF
<b>1</b>	38	35.0	30	13.0	KB 1970 15-27, KB 1975 15-27	0.169	6169900	K 19 1AF
<b>1.1/16</b>	50	38.0	30	13.0	KB 1970 15-27, KB 1975 15-27	0.173	6164350	K 19 1.1/16AF
<b>1.1/8</b>	40	38.0	30	16.5	KB 1970 15-27, KB 1975 15-27	0.180	6164510	K 19 1.1/8AF
<b>1.1/4</b>	40	44.0	35	17.0	KB 1970 15-27, KB 1975 15-27	0.284	6165240	K 19 1.1/4AF
<b>1.5/16</b>	43	45.0	35	19.0	KB 1970 15-27, KB 1975 15-27	0.296	6165320	K 19 1.5/16AF

## K 19 L IMPACT SOCKET 1/2"

hexagon, long pattern

- > Machine-operated, suitable for all standard electric and air tools
- > Square drive as per DIN 3121 - G 12.5, ISO 1174
- > GEDORE special steel, manganese-phosphated

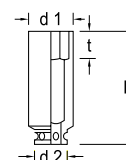

Ømm	L	d <sub>1</sub>	d <sub>2</sub>	t	recommended accessories	kg	Code	No.
<b>8</b>	77	15.3	25	12	KB 1970 10-14, KB 1975 10-14	0.124	6163110	K 19 L 8
<b>10</b>	77	17.8	25	12	KB 1970 10-14, KB 1975 10-14	0.140	6163380	K 19 L 10
<b>13</b>	77	21.5	25	13	KB 1970 10-14, KB 1975 10-14	0.158	6163540	K 19 L 13
<b>14</b>	77	22.8	25	13	KB 1970 10-14, KB 1975 10-14	0.171	6163620	K 19 L 14
<b>16</b>	77	24.0	30	14	KB 1970 15-27, KB 1975 15-27	0.208	6197790	K 19 L 16
<b>17</b>	80	26.5	30	15	KB 1970 15-27, KB 1975 15-27	0.230	6163890	K 19 L 17
<b>18</b>	82	27.8	30	15	KB 1970 15-27, KB 1975 15-27	0.255	6197870	K 19 L 18
<b>19</b>	82	29.0	30	17	KB 1970 15-27, KB 1975 15-27	0.265	6164000	K 19 L 19
<b>21</b>	82	31.5	30	17	KB 1970 15-27, KB 1975 15-27	0.306	6162730	K 19 L 21
<b>22</b>	82	32.8	30	19	KB 1970 15-27, KB 1975 15-27	0.318	6164270	K 19 L 22
<b>23</b>	82	34.0	30	19	KB 1970 15-27, KB 1975 15-27	0.328	6199810	K 19 L 23
<b>24</b>	82	35.3	30	21	KB 1970 15-27, KB 1975 15-27	0.358	6164430	K 19 L 24
<b>27</b>	82	39.0	30	22	KB 1970 15-27, KB 1975 15-27	0.396	6164780	K 19 L 27

# K 19 LS

## IMPACT SOCKET 1/2" WITH PROTECTIVE SLEEVE

hexagon, long pattern

- > Machine-operated, suitable for all standard electric and air tools
- > Square drive as per DIN 3121 - G 12.5, ISO 1174
- > Thin-walled to protect the alloy wheels
- > GEDORE special steel, manganese-phosphated

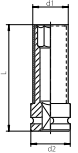

Ø mm	Colour	RAL	L	d <sub>1</sub>	d <sub>2</sub>	t	recommended accessories	kg	Code	No.
17	Traffic blue	5017	81	27.0	30	15	KB 1970 15-27, KB 1975 15-27	0.200	2178214	K 19 LS 17
19	Traffic green	6024	82	29.0	30	17	KB 1970 15-27, KB 1975 15-27	0.210	2178222	K 19 LS 19
21	Traffic red	3020	82	30.5	30	17	KB 1970 15-27, KB 1975 15-27	0.230	2178230	K 19 LS 21
22	Traffic yellow	1023	82	32.3	30	19	KB 1970 15-27, KB 1975 15-27	0.260	2178249	K 19 LS 22

# KR 19

## IMPACT SOCKET 1/2"

hexagon, for cars

- > Suitable for all standard electric and air tools
- > GEDORE special steel, gun-metal finish
- > Square drive as per DIN 3121 - G 12.5, ISO 1174

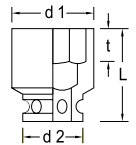

Ø mm	L	d <sub>1</sub>	d <sub>2</sub>	t	recommended accessories	kg	Code	No.
17	38	30	30	14	KB 1970 15-27, KB 1975 15-27	0.174	6162490	KR 19 17
19	38	33	30	18	KB 1970 15-27, KB 1975 15-27	0.186	6162570	KR 19 19

# ITX K 19

## IMPACT SCREWDRIVER BIT SOCKET 1/2"

for recessed TORX® head screws

- > Square drive as per DIN 3121 - G 12.5, ISO 1174
- > GEDORE special steel, manganese-phosphated
- > TORX® = reg. trademark of Acument Intellectual Properties, LLC. USA

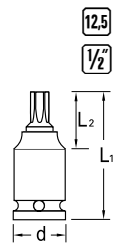

Ø	M	mm	L <sub>1</sub>	L <sub>2</sub>	d	recommended accessories	kg	Code	No.
T30	M6 - M7	5,52	47	26	25	KB 1970 10-14, KB 1975 10-14	0.075	6197280	ITX K 19 T30
T40	M7 - M8	6,65	47	26	25	KB 1970 10-14, KB 1975 10-14	0.077	6197360	ITX K 19 T40
T45	M8 - M10	7,82	47	26	25	KB 1970 10-14, KB 1975 10-14	0.078	1603124	ITX K 19 T45
T50	M10	8,83	47	26	25	KB 1970 10-14, KB 1975 10-14	0.079	6197440	ITX K 19 T50
T55	M12	11,22	47	26	25	KB 1970 10-14, KB 1975 10-14	0.084	6197520	ITX K 19 T55
T60	M14	13,25	47	26	25	KB 1970 10-14, KB 1975 10-14	0.088	6197600	ITX K 19 T60



# TX K 19

## IMPACT SOCKET 1/2"

for protruding TORX® head screws

- > Machine-operated, suitable for all standard electric and air tools
- > Square drive as per DIN 3121 - G 12.5, ISO 1174
- > GEDORE special steel, gun-metal finish
- > TORX® = reg. trademark of Acument Intellectual Properties, LLC. USA

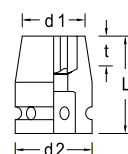

⊗	▣ M	★ mm	L	d <sub>1</sub>	d <sub>2</sub>	t	recommended accessories	⚖ kg	Code	No.
E10	M8	9,42	38	15.0	25	9	KB 1970 10-14, KB 1975 10-14	0.084	6223110	TX K 19 E10
E12	M10	11,17	38	16.0	25	10	KB 1970 10-14, KB 1975 10-14	0.085	6223380	TX K 19 E12
E14	M12	12,90	38	18.5	25	12	KB 1970 10-14, KB 1975 10-14	0.086	6223460	TX K 19 E14
E16	M12	14,76	38	20.0	25	12	KB 1970 10-14, KB 1975 10-14	0.088	6223540	TX K 19 E16
E18	M14	16,70	38	22.0	25	12	KB 1970 10-14, KB 1975 10-14	0.087	6223620	TX K 19 E18
E20	M16	18,45	38	25.0	30	13	KB 1970 15-27, KB 1975 15-27	0.140	6223700	TX K 19 E20
E24	M18 - M20	22,16	45	28.5	30	17	KB 1970 15-27, KB 1975 15-27	0.137	6223890	TX K 19 E24

# IN K 19

## IMPACT SCREWDRIVER BIT SOCKET 1/2"

for in-hex screws

- > Suitable for all standard electric and air tools
- > Square drive as per DIN 3121 - G 12.5, ISO 1174
- > GEDORE special steel, manganese-phosphated



IN K 19 5



IN K 19 17

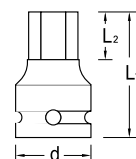

● mm	L <sub>1</sub>	L <sub>2</sub>	d	recommended accessories	⚖ kg	Code	No.
5	44	7.5	25	KB 1970 10-14, KB 1975 10-14	0.073	6223970	IN K 19 5
6	44	9.0	25	KB 1970 10-14, KB 1975 10-14	0.072	6224000	IN K 19 6
8	44	11.0	25	KB 1970 10-14, KB 1975 10-14	0.077	6224190	IN K 19 8
10	44	13.0	25	KB 1970 10-14, KB 1975 10-14	0.079	6224270	IN K 19 10
12	50	15.0	30	KB 1970 15-27, KB 1975 15-27	0.136	6224350	IN K 19 12
14	50	17.0	30	KB 1970 15-27, KB 1975 15-27	0.144	6225320	IN K 19 14
17	50	19.0	30	KB 1970 15-27, KB 1975 15-27	0.157	6225670	IN K 19 17

## KB 1930 REDUCER 1/2" TO 3/8"

for impact sockets

- > With square drive as per DIN 3121 - G 12.5, Form F, G, and H
- > GEDORE special steel, manganese-phosphated



1/2"	12.5	3/8"	10	↳ mm	↳ kg	Code	No.
1/2	12.5	3/8	10	44	0.081	6650370	KB 1930

## KB 1932 CONVERTOR 1/2" TO 3/4"

for impact sockets

- > With square drive as per DIN 3121 - G 12.5, Form F, G, and H
- > GEDORE special steel, manganese-phosphated



1/2"	12.5	3/4"	20	↳ mm	↳ kg	Code	No.
1/2	12.5	3/4	20	44	0.146	6650020	KB 1932

## KB 1990 EXTENSION 1/2"

for impact sockets

- > With square drive as per DIN 3121 - G 12.5, ISO 1174 Form F, G, and H
- > GEDORE special steel, manganese-phosphated



KB 1990-5



KB 1990-10

1/2"	12.5	↳ mm	↳ kg	Code	No.
1/2	12.5	125	0.256	6655250	KB 1990-5
1/2	12.5	250	0.461	6650100	KB 1990-10

## KB 1995 UNIVERSAL JOINT 1/2"

for impact sockets

- > With square drive as per DIN 3121 - G 12.5, Form F, G, and H
- > GEDORE special steel, manganese-phosphated



1/2"	12.5	1/2"	12.5	↳ mm	↳ kg	Code	No.
1/2	12.5	1/2	12.5	62	0.202	6655410	KB 1995

## KB 1970 - KB 1975 SAFETY RING AND SAFETY PIN

for impact sockets 1/2"



KB 1970



KB 1975

Description	∅	↳ mm	↳ kg	Code	No.
<b>Safety ring d 19 mm</b>	19		0.002	6654790	KB 1970 10-14
<b>Safety ring d 24 mm</b>	24		0.002	6654870	KB 1970 15-27
<b>Safety pin d 3 mm</b>	3	20	0.002	6654950	KB 1975 10-14
<b>Safety pin d 3 mm</b>	3	25	0.002	6655090	KB 1975 15-27

20 (3/4") square drive

# K 32-040

## IMPACT SOCKET SET 3/4" FOR TRUCKS

20  
3/4"

4 pieces

- > 4 sockets, machine-operated, suitable for all standard electric and air tools
- > Square drive as per DIN 3121 - H 20, ISO 1174
- > GEDORE special steel, gun-metal finish
- > In black plastic case



Sockets		Code	No.
○ 24 27 30 33	1.630	1828142	K 32-040

# K 32 S

## IMPACT SOCKET 3/4" WITH IMPACT-FIX LOCK

hexagon UD profile

- > Acc. to DIN 3129, ISO 2725-2
- > Machine-operated, suitable for all standard electric and air tools
- > Square drive as per DIN 3121 - H 20, ISO 1174
- > GEDORE vanadium steel 59CrV4
- > Gun-metal finish
- > DBGM (German utility patent)
- > Particularly suitable for working in sensitive areas permanently governed by certainty against loss, process reliability and occupational safety
- > Examples: overhead power line construction, wind power plants or the automotive sector

20  
3/4"

# K 32 SL

## IMPACT SOCKET 3/4" WITH IMPACT-FIX LOCK

hexagon UD profile, long pattern

- > Machine-operated, suitable for all standard electric and air tools
- > Square drive as per DIN 3121 - H 20, ISO 1174
- > GEDORE vanadium steel 59CrV4
- > Gun-metal finish
- > DBGM (German utility patent)
- > Particularly suitable for working in sensitive areas permanently governed by certainty against loss, process reliability and occupational safety
- > Examples: overhead power line construction, wind power plants or the automotive sector

20  
3/4"

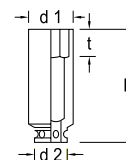
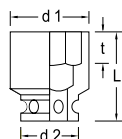

○ mm	L	d <sub>1</sub>	d <sub>2</sub>	t		Code	No.
17	45	31.1	44	7.0	0.400	2734060	K 32 S 17
18	45	32.4	44	8.4	0.420	2734079	K 32 S 18
19	45	33.6	44	8.4	0.400	2734095	K 32 S 19
22	46	37.4	44	9.8	0.400	2734176	K 32 S 22
24	46	39.9	44	11.2	0.340	2734184	K 32 S 24
27	48	43.6	44	12.6	0.400	2734206	K 32 S 27
30	52	47.4	44	14.0	0.400	2734214	K 32 S 30
32	52	49.9	44	15.4	0.400	2734230	K 32 S 32
33	54	51.0	44	15.4	0.400	2734257	K 32 S 33
34	54	52.4	44	15.4	0.400	2734265	K 32 S 34
36	56	54.9	44	16.8	0.500	2734273	K 32 S 36
38	59	57.0	44	16.8	0.500	2734281	K 32 S 38
41	59	61.1	44	18.9	0.560	2734303	K 32 S 41

○ mm	L	d <sub>1</sub>	d <sub>2</sub>	t		Code	No.
17	90	31.1	44	7.0	0.560	2734311	K 32 SL 17
19	90	32.4	44	8.4	0.600	2734338	K 32 SL 19
21	90	36.1	44	9.8	0.600	2734346	K 32 SL 21
22	90	37.4	44	9.8	0.620	2734354	K 32 SL 22
24	90	39.9	44	11.2	0.620	2734362	K 32 SL 24
27	90	43.6	44	12.6	0.600	2734370	K 32 SL 27
30	90	47.4	44	14.0	0.600	2734389	K 32 SL 30
32	90	49.9	44	15.4	0.700	2734397	K 32 SL 32
33	90	51.0	44	15.4	0.800	2734400	K 32 SL 33
34	90	52.4	44	15.4	0.800	2734419	K 32 SL 34
36	90	54.9	44	16.8	0.800	2734427	K 32 SL 36
41	90	61.1	44	18.9	0.980	2734435	K 32 SL 41

# K 32 (MM)

## IMPACT SOCKET 3/4"

hexagon

- > Acc. to DIN 3129, ISO 2725-2
- > Machine-operated, suitable for all standard electric and air tools
- > Square drive as per DIN 3121 - H 20, ISO 1174
- > GEDORE special steel, gun-metal finish
- \* not standardised

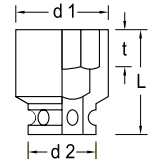

Ø mm	L	d <sub>1</sub>	d <sub>2</sub>	t	recommended accessories	🏋️	Code	No.
17	50	29	44	9.0	KB 3270, KB 3275	0.300	6282040	K 32 17
18	50	32	44	9.0	KB 3270, KB 3275	0.300	6289990	K 32 18
19	50	32	44	9.5	KB 3270, KB 3275	0.293	6282120	K 32 19
22	50	38	44	11.0	KB 3270, KB 3275	0.345	6282200	K 32 22
24	50	40	44	13.0	KB 3270, KB 3275	0.339	6282390	K 32 24
27	54	41	44	13.0	KB 3270, KB 3275	0.339	6282470	K 32 27
30	54	44	44	16.5	KB 3270, KB 3275	0.352	6282550	K 32 30

Ø mm	L	d <sub>1</sub>	d <sub>2</sub>	t	recommended accessories	🏋️	Code	No.
32	56	49	44	17.0	KB 3270, KB 3275	0.407	6282630	K 32 32
33	56	49	44	17.0	* KB 3270, KB 3275	0.430	6283010	K 32 33 (3/4W)
34	56	52	44	19.0	KB 3270, KB 3275	0.475	6281580	K 32 34
36	56	52	44	19.0	KB 3270, KB 3275	0.444	6282710	K 32 36
38	58	54	44	22.0	* KB 3270, KB 3275	0.481	6281740	K 32 38
41	58	57	44	22.0	KB 3270, KB 3275	0.500	6282980	K 32 41

# K 32 (AF)

## IMPACT SOCKET 3/4"

hexagon

- > Machine-operated, suitable for all standard electric and air tools
- > Square drive as per DIN 3121 - H 20, ISO 1174
- > GEDORE special steel, gun-metal finish

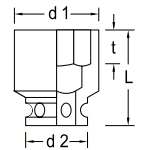

Ø "AF	L	d <sub>1</sub>	d <sub>2</sub>	t	recommended accessories	🏋️	Code	No.
13/16	46	35	44	11.0	KB 3270, KB 3275	0.349	6285300	K 32 13/16AF
7/8	46	38	44	13.0	KB 3270, KB 3275	0.354	6284410	K 32 7/8AF
15/16	46	40	44	13.0	KB 3270, KB 3275	0.342	6284680	K 32 15/16AF
1	46	41	44	13.0	KB 3270, KB 3275	0.340	6285490	K 32 1AF
1.1/16	48	41	44	13.0	KB 3270, KB 3275	0.347	6285650	K 32 1.1/16AF
1.1/8	52	44	44	16.5	KB 3270, KB 3275	0.367	6284760	K 32 1.1/8AF
1.1/4	52	49	44	17.0	KB 3270, KB 3275	0.418	6284840	K 32 1.1/4AF
1.5/16	55	49	44	19.0	KB 3270, KB 3275	0.417	6284920	K 32 1.5/16AF

Ø "AF	L	d <sub>1</sub>	d <sub>2</sub>	t	recommended accessories	🏋️	Code	No.
1.3/8	55	52	44	19.0	KB 3270, KB 3275	0.452	6285730	K 32 1.3/8AF
1.7/16	56	52	44	19.0	KB 3270, KB 3275	0.439	6285060	K 32 1.7/16AF
1.1/2	59	54	44	22.0	KB 3270, KB 3275	0.480	6285140	K 32 1.1/2AF
1.5/8	59	57	44	22.0	KB 3270, KB 3275	0.497	6285810	K 32 1.5/8AF
1.11/16	64	63	44	25.0	KB 3270, KB 3275	0.674	6286030	K 32 1.11/16AF
1.3/4	64	63	44	25.5	KB 3270, KB 3275	0.639	6286110	K 32 1.3/4AF
1.7/8	67	67	54	27.0	KB 3270, KB 3275	0.873	6286380	K 32 1.7/8AF
2	67	73	54	27.0	KB 3270, KB 3275	0.995	6286460	K 32 2AF

# K 32 L

## IMPACT SOCKET 3/4"

hexagon, long pattern

- > Machine-operated, suitable for all standard electric and air tools
- > Square drive as per DIN 3121 - H 20, ISO 1174
- > GEDORE special steel, gun-metal finish

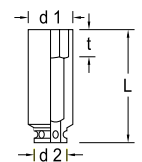

Ø mm	L	d <sub>1</sub>	d <sub>2</sub>	t	recommended accessories	🏋️	Code	No.
17	90	29	44	9.0	KB 3270, KB 3275	0.727	6283600	K 32 L 17
19	95	32	44	9.5	KB 3270, KB 3275	0.720	6283790	K 32 L 19
21	95	35	44	11.0	KB 3270, KB 3275	0.757	6286700	K 32 L 21
22	95	38	44	11.0	KB 3270, KB 3275	0.739	6283870	K 32 L 22
24	95	40	44	13.0	KB 3270, KB 3275	0.706	6283950	K 32 L 24
27	95	41	44	13.0	KB 3270, KB 3275	0.655	6284090	K 32 L 27

Ø mm	L	d <sub>1</sub>	d <sub>2</sub>	t	recommended accessories	🏋️	Code	No.
30	95	44	44	16.5	KB 3270, KB 3275	0.644	6284170	K 32 L 30
32	95	49	44	17.0	KB 3270, KB 3275	0.728	6284250	K 32 L 32
33	95	49	44	17.0	KB 3270, KB 3275	0.709	6286540	K 32 L 33 (3/4W)
34	95	52	44	19.0	KB 3270, KB 3275	0.858	6281660	K 32 L 34
36	95	52	44	19.0	KB 3270, KB 3275	0.826	6284330	K 32 L 36
41	95	57	44	22.0	KB 3270, KB 3275	0.811	6286890	K 32 L 41





## IN K 32 IMPACT SCREWDRIVER BIT SOCKET 3/4"

for in-hex screws

- > Suitable for all standard electric and air tools
- > Square drive as per DIN 3121 - H 20, ISO 1174
- > GEDORE special steel, manganese-phosphated



mm	L <sub>1</sub>	L <sub>2</sub>	d	recommended accessories	kg	Code	No.
14	65	14	38	KB 3270, KB 3275	0.440	1956477	IN K 32 14
17	65	17	38	KB 3270, KB 3275	0.495	1956485	IN K 32 17
19	65	19	44	KB 3270, KB 3275	0.530	1956493	IN K 32 19
22	65	22	44	KB 3270, KB 3275	0.590	1956507	IN K 32 22
24	65	24	44	KB 3270, KB 3275	0.630	1956515	IN K 32 24
27	65	27	44	KB 3270, KB 3275	0.695	1956523	IN K 32 27

## KB 3221 CONVERTOR 3/4" TO 1"

for impact sockets

- > With square drive as per DIN 3121, ISO 1174, Form F and H
- > GEDORE special steel, manganese-phosphated

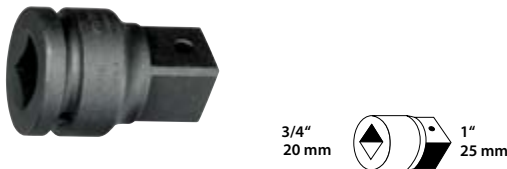

"	"	"	"	mm	kg	Code	No.
3/4	20	1	25	65	0.445	6671530	KB 3221

## KB 3295 UNIVERSAL JOINT 3/4"

for impact sockets

- > With square drive as per DIN 3121, ISO 1174, Form F and H
- > GEDORE special steel, manganese-phosphated



"	"	"	"	mm	kg	Code	No.
3/4	20	3/4	20	94	0.623	6676090	KB 3295

## KB 3219 REDUCER 3/4" TO 1/2"

for impact sockets

- > With square drive as per DIN 3121, ISO 1174, Form F and H
- > GEDORE special steel, manganese-phosphated

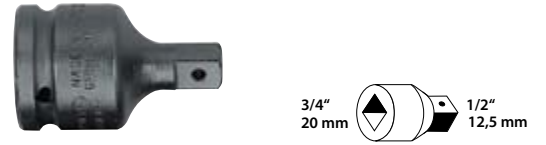

"	"	"	"	mm	kg	Code	No.
3/4	20	1/2	12.5	65	0.351	6675280	KB 3219

## KB 3290 EXTENSION 3/4"

for impact sockets

- > With square drive as per DIN 3121, ISO 1174, Form F and H
- > GEDORE special steel, manganese-phosphated



"	"	mm	kg	Code	No.
3/4	20	205	0.957	6675600	KB 3290-8
3/4	20	300	1.328	6675790	KB 3290-12
3/4	20	400	1.759	6675870	KB 3290-16

## KB 3270 - KB 3275 SAFETY RING AND SAFETY PIN

for impact sockets 3/4"



Description	Ø	mm	kg	Code	No.
Safety ring d 36 mm	36		0.004	6675360	KB 3270
Safety pin d 4 mm	4	35	0.004	6675440	KB 3275

# IMPACT-FIX LOCK

## Your advantages

- > Integrated, secure two-pin lock including ring
- > An extra feature from GEDORE - for increased safety in the workplace
- > Particularly suitable for working in sensitive areas permanently governed by certainty against loss, process reliability and occupational safety
- > Examples: overhead power line construction, wind power plants, machine engineering or the automotive sector
- > Very safe and extremely practice-oriented, and very easy to handle
- > Double ring groove for easily sliding the ring
- > Minimisation of the risk of injury compared to standard systems available on the market. The securing ring is not catapulted out of the rotating insert if the securing pin tears.
- > Wherever major forces prevail, correct and appropriate securing and handling of tools is a key element of good screwed connections.
- > Standard practice: the bothersome and awkward fitting of the loose securing pin and ring is often simply neglected or forgotten, or the pin and ring are no longer to be found.
- > Thanks to the Impact-Fix lock integrated in the socket, 3 elements no longer need to be installed (insert, pin and ring). The securing pins and rings are always secured to the socket (3 in 1). The pins are automatically pressed into the drill holes in the square drive when the ring is secured in place.
- > DBGM (German utility patent)



## 3 in 1

### THE ADVANTAGE IS OBVIOUS:

thanks to the Impact-Fix lock integrated in the socket, three elements no longer need to be installed (insert, pin and ring).



## MACHINE- OR HAND-OPERATED...

... electric, hydraulic, pneumatic or with torque multiplier by hand

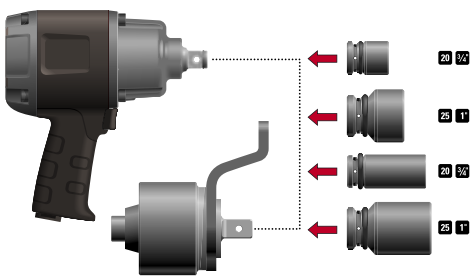

## EASY TO USE ...

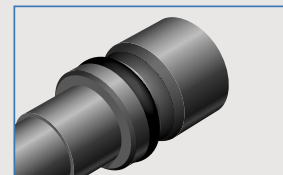
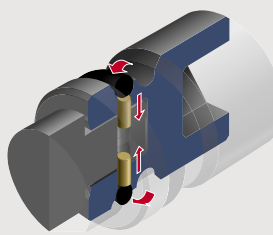
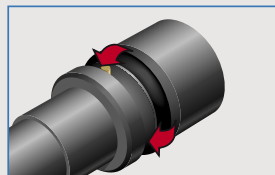
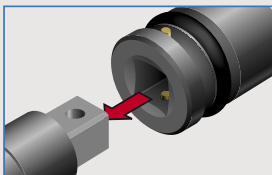

Double ring groove for easily sliding the ring thanks to integrated two-pin lock including ring.



# K 21 (MM)

## IMPACT SOCKET 1"

hexagon

- > Acc. to DIN 3129, ISO 2725-2
- > Machine-operated, suitable for all standard electric and air tools
- > Square drive as per DIN 3121 - H 25, ISO 1174
- > GEDORE special steel, gun-metal finish
- > Use KB 3770 and KB 3775 from 75 mm and up \* not standardised

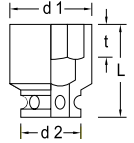

Ø mm	L	d <sub>1</sub>	d <sub>2</sub>	t	recommended accessories	⚖️	Code	No.
22	60	40	54	11.0	KB 2170, KB 2175	0.561	6183060	K 21 22
24	60	42	54	13.0	KB 2170, KB 2175	0.611	6183140	K 21 24
27	60	46	54	13.0	KB 2170, KB 2175	0.614	6183220	K 21 27
30	58	50	54	16.5	KB 2170, KB 2175	0.619	6183300	K 21 30
32	62	51	54	17.0	KB 2170, KB 2175	0.608	6183490	K 21 32
33	60	54	54	17.0	* KB 2170, KB 2175	0.615	6183650	K 21 33
34	62	54	54	19.0	KB 2170, KB 2175	0.624	6196980	K 21 34
36	67	54	54	19.0	KB 2170, KB 2175	0.598	6183570	K 21 36
38	67	60	54	19.0	* KB 2170, KB 2175	0.764	6184890	K 21 38
41	67	63	54	22.0	KB 2170, KB 2175	0.794	6183730	K 21 41

Ø mm	L	d <sub>1</sub>	d <sub>2</sub>	t	recommended accessories	⚖️	Code	No.
42	74	63	54	22.0	* KB 2170, KB 2175	0.781	6184970	K 21 42
46	74	70	54	25.5	KB 2170, KB 2175	0.974	6183810	K 21 46
50	80	73	54	27.0	KB 2170, KB 2175	1.018	6184030	K 21 50
55	84	82	54	30.0	KB 2170, KB 2175	1.298	6184110	K 21 55
60	87	86	54	33.0	KB 2170, KB 2175	1.481	6184380	K 21 60
65	90	92	54	35.0	KB 2170, KB 2175	1.682	6184460	K 21 65
70	96	96	54	38.0	KB 2170, KB 2175	1.812	6184540	K 21 70
75	98	100	86	41.0	* KB 3770, KB 3775	2.690	6184620	K 21 75
80	100	105	86	44.0	* KB 3770, KB 3775	2.936	6184700	K 21 80

# K 21 (AF)

## IMPACT SOCKET 1"

hexagon

- > Machine-operated, suitable for all standard electric and air tools
- > Square drive as per DIN 3121 - H 25, ISO 1174
- > GEDORE special steel, gun-metal finish

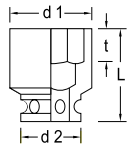

Ø"AF	L	d <sub>1</sub>	d <sub>2</sub>	t	recommended accessories	⚖️	Code	No.
1	55	43	54	13.0	KB 2170, KB 2175	0.611	6186320	K 21 1AF
1.1/4	57	51	54	17.0	KB 2170, KB 2175	0.614	6186400	K 21 1.1/4AF
1.7/16	60	54	54	19.0	KB 2170, KB 2175	0.593	6186590	K 21 1.7/16AF
1.1/2	64	60	54	22.0	KB 2170, KB 2175	0.776	6186750	K 21 1.1/2AF

Ø"AF	L	d <sub>1</sub>	d <sub>2</sub>	t	recommended accessories	⚖️	Code	No.
1.5/8	64	63	54	22.0	KB 2170, KB 2175	0.796	6186670	K 21 1.5/8AF
1.13/16	69	70	54	25.5	KB 2170, KB 2175	0.972	6186830	K 21 1.13/16AF
1.7/8	72	70	54	27.0	KB 2170, KB 2175	0.981	6186910	K 21 1.7/8AF
2.1/4	80	82	54	33.0	KB 2170, KB 2175	1.365	6187050	K 21 2.1/4AF

# K 21 L

## IMPACT SOCKET 1"

hexagon, long pattern

- > Machine-operated, suitable for all standard electric and air tools
- > Square drive as per DIN 3121 - H 25, ISO 1174
- > GEDORE special steel, gun-metal finish

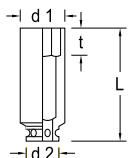

Ø mm	L	d <sub>1</sub>	d <sub>2</sub>	t	recommended accessories	⚖️	Code	No.
22	100	40	54	11.0	KB 2170, KB 2175	1.103	6185350	K 21 L 22
24	100	42	54	13.0	KB 2170, KB 2175	1.234	6185430	K 21 L 24
27	100	46	54	13.0	KB 2170, KB 2175	1.227	6185510	K 21 L 27
30	100	50	54	16.5	KB 2170, KB 2175	1.141	6185780	K 21 L 30
32	100	51	54	17.0	KB 2170, KB 2175	1.101	6185860	K 21 L 32
33	100	54	54	17.0	KB 2170, KB 2175	1.104	6197950	K 21 L 33

Ø mm	L	d <sub>1</sub>	d <sub>2</sub>	t	recommended accessories	⚖️	Code	No.
34	100	54	54	19.0	KB 2170, KB 2175	1.189	6197010	K 21 L 34
36	100	54	54	19.0	KB 2170, KB 2175	1.022	6185940	K 21 L 36
38	100	60	54	22.0	KB 2170, KB 2175	1.262	6186080	K 21 L 38
41	100	63	54	22.0	KB 2170, KB 2175	1.420	6186160	K 21 L 41
46	100	70	54	25.5	KB 2170, KB 2175	1.619	6186240	K 21 L 46

## IN K 21 IMPACT SCREWDRIVER BIT SOCKET 1"

for in-hex screws

- > Suitable for all standard electric and air tools
- > Square drive as per DIN 3121 - H 25, ISO 1174
- > GEDORE special steel, manganese-phosphated



mm	L <sub>1</sub>	L <sub>2</sub>	d	recommended accessories	kg	Code	No.
19	75	21	54	KB 2170, KB 2175	0.650	1956558	IN K 21 19
22	75	24	54	KB 2170, KB 2175	0.675	1956566	IN K 21 22
24	75	26	54	KB 2170, KB 2175	0.700	1956574	IN K 21 24
27	75	28	54	KB 2170, KB 2175	0.730	1956582	IN K 21 27
30	75	29	54	KB 2170, KB 2175	0.770	1577514	IN K 21 30
32	75	30	54	KB 2170, KB 2175	0.900	1956590	IN K 21 32
36	75	30	54	KB 2170, KB 2175	0.860	1956604	IN K 21 36

## KB 2132 REDUCER 1" TO 3/4"

for impact sockets

- > Square drive as per DIN 3121, ISO 1174, Form F and H
- > GEDORE special steel, manganese-phosphated

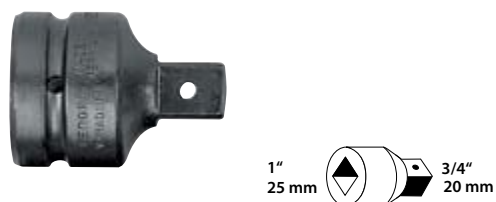

"	"	"	"	mm	kg	Code	No.
1	25	3/4	20	75	0.661	6657460	KB 2132

## KB 2190 EXTENSION 1"

for impact sockets

- > Square drive as per DIN 3121, ISO 1174, Form F and H
- > GEDORE special steel, manganese-phosphated



"	"	mm	kg	Code	No.
1	25	208	1.477	6657970	KB 2190-8
1	25	300	2.010	6658000	KB 2190-12
1	25	405	2.587	6658190	KB 2190-16

## KB 2137 CONVERTOR 1" TO 1.1/2"

for impact sockets

- > Square drive as per DIN 3121, ISO 1174, Form F and H
- > GEDORE special steel, manganese-phosphated



"	"	"	"	mm	kg	Code	No.
1	25	1.1/2	40	82	0.988	6657890	KB 2137

## KB 2195 UNIVERSAL JOINT 1"

for impact sockets

- > Square drive as per DIN 3121, ISO 1174, Form F and H
- > GEDORE special steel, manganese-phosphated



"	"	"	"	mm	kg	Code	No.
1	25	1	25	140	1.425	6658350	KB 2195

## KB 2170 - KB 2175 SAFETY RING AND SAFETY PIN 1"

for impact sockets 1"

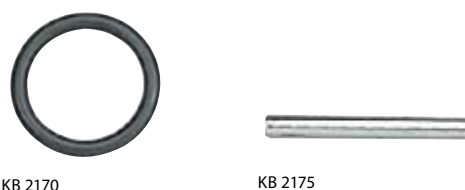

Description	Ø	mm	kg	Code	No.
Safety ring d 45 mm	45		0.008	6657620	KB 2170
Safety pin d 5 mm	5	45	0.007	6657700	KB 2175

## 40 (1.1/2") square drive

### K 37 IMPACT SOCKET 1.1/2"

hexagon

- > Acc. to DIN 3129, ISO 2725-2
- > Machine-operated, suitable for all standard electric and air tools
- > Square drive as per DIN 3121 - H 40, ISO 1174
- > GEDORE special steel, gun-metal finish
- > Use KB 6470 and KB 6475 from 95 mm and up
- \* not standardised

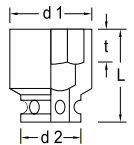

Ø mm	L	d <sub>1</sub>	d <sub>2</sub>	t	recommended accessories	⚖️	Code	No.
46	84	76	86	25.5	KB 3770, KB 3775	2.3	6328130	K 37 46
50	87	81	86	27.0	* KB 3770, KB 3775	2.3	6328210	K 37 50
55	90	86	86	30.0	KB 3770, KB 3775	2.5	6328480	K 37 55
60	92	93	86	33.0	KB 3770, KB 3775	2.7	6328560	K 37 60
65	95	97	86	35.0	KB 3770, KB 3775	3.2	6328640	K 37 65
70	100	105	86	38.0	KB 3770, KB 3775	3.5	6328720	K 37 70
75	103	110	86	41.0	KB 3770, KB 3775	3.7	6328800	K 37 75
80	110	116	86	44.0	KB 3770, KB 3775	4.2	6328990	K 37 80
85	118	125	86	47.0	KB 3770, KB 3775	4.8	6329020	K 37 85

Ø mm	L	d <sub>1</sub>	d <sub>2</sub>	t	recommended accessories	⚖️	Code	No.
90	118	130	86	49.0	KB 3770, KB 3775	5.5	6329100	K 37 90
95	118	137	95	49.0	* KB 6470, KB 6475	9.0	6329290	K 37 95
100	125	140	127	54.0	* KB 6470, KB 6475	8.1	6329370	K 37 100
105	125	150	127	54.0	* KB 6470, KB 6475	9.3	6329450	K 37 105
110	137	156	127	62.0	* KB 6470, KB 6475	10.6	6329530	K 37 110
115	137	160	127	67.0	* KB 6470, KB 6475	10.6	6329610	K 37 115
120	145	168	127	67.0	* KB 6470, KB 6475	11.8	6329880	K 37 120

### K 37 L IMPACT SOCKET 1.1/2"

hexagon, long pattern

- > Machine-operated, suitable for all standard electric and air tools
- > Square drive as per DIN 3121 - H 40, ISO 1174
- > GEDORE special steel, gun-metal finish
- > Use KB 6470 and KB 6475 from 95 mm and up

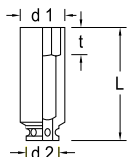

Ø mm	L	d <sub>1</sub>	d <sub>2</sub>	t	recommended accessories	⚖️	Code	No.
41	140	70	86	22.0	KB 3770, KB 3775	4.4	6330110	K 37 L 41
46	140	75	86	25.5	KB 3770, KB 3775	4.3	6330380	K 37 L 46
50	140	80	86	27.0	KB 3770, KB 3775	4.4	6330460	K 37 L 50
55	140	86	86	30.0	KB 3770, KB 3775	4.0	6330540	K 37 L 55
60	140	92	86	33.0	KB 3770, KB 3775	4.1	6330620	K 37 L 60
65	140	100	86	35.0	KB 3770, KB 3775	4.6	6330700	K 37 L 65
70	140	105	86	38.0	KB 3770, KB 3775	4.8	6330890	K 37 L 70
75	140	109	86	41.0	KB 3770, KB 3775	5.4	6330970	K 37 L 75
80	140	115	86	44.0	KB 3770, KB 3775	5.7	6331000	K 37 L 80

Ø mm	L	d <sub>1</sub>	d <sub>2</sub>	t	recommended accessories	⚖️	Code	No.
85	140	121	86	47.0	KB 3770, KB 3775	6.2	6331190	K 37 L 85
90	140	130	86	49.0	KB 3770, KB 3775	6.6	6331270	K 37 L 90
95	150	137	127	49.0	KB 6470, KB 6475	10.0	6331350	K 37 L 95
100	150	144	127	54.0	KB 6470, KB 6475	10.0	6331430	K 37 L 100
105	150	154	127	54.0	KB 6470, KB 6475	11.3	6331510	K 37 L 105
110	160	157	127	62.0	KB 6470, KB 6475	12.8	6331780	K 37 L 110
115	160	164	127	67.0	KB 6470, KB 6475	12.2	6331860	K 37 L 115
120	170	167	127	67.0	KB 6470, KB 6475	13.8	6331940	K 37 L 120

### KB 3721 REDUCER 1.1/2" TO 1"

for impact sockets

- > Square drive as per DIN 3121, ISO 1174, Form F and H
- > GEDORE special steel, gun-metal finish



□ "	□	■ "	■	↳ mm ↳	⚖️	Code	No.
1.1/2	40	1	25	95	1.992	6676410	KB 3721



## KB 3764 CONVERTOR 1.1/2" TO 2.1/2"

for impact sockets

- > Square drive as per DIN 3121, ISO 1174, Form F and H
- > GEDORE special steel, gun-metal finish



"	"	"	"	∅	↳ mm ↳	↳ kg ↳	Code	No.
1.1/2	40	2.1/2	63	86	93	3.6	1531220	KB 3764

## KB 3770 - KB 3775 SAFETY RING AND SAFETY PIN

for impact sockets 1.1/2"



KB 3770



KB 3775

Description	∅	↳ mm ↳	↳ kg ↳	Code	No.
<b>Safety ring d 75 mm</b>	75		0.026	6676760	KB 3770
<b>Safety pin d 6 mm</b>	6	75	0.017	6676840	KB 3775

63 (2.1/2") square drive

## K 64 IMPACT SOCKET 2.1/2"

hexagon

- > Acc. to DIN 3129, ISO 2725-2
- > Machine-operated, suitable for all standard electric and air tools
- > Square drive as per DIN 3121 - H 63, ISO 1174
- > GEDORE special steel, gun-metal finish
- \* not standardised

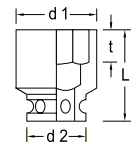

∅ mm	L	d <sub>1</sub>	d <sub>2</sub>	t	recommended accessories	↳ kg ↳	Code	No.
75	125	115	127	41	KB 6470, KB 6475	7.4	6371300	K 64 75
80	125	115	127	44	KB 6470, KB 6475	7.0	6371490	K 64 80
85	130	127	127	47	KB 6470, KB 6475	7.3	6371570	K 64 85
90	132	135	127	49	KB 6470, KB 6475	8.0	6371650	K 64 90
95	132	140	127	49	KB 6470, KB 6475	8.1	6371730	K 64 95

∅ mm	L	d <sub>1</sub>	d <sub>2</sub>	t	recommended accessories	↳ kg ↳	Code	No.
100	141	145	127	54	KB 6470, KB 6475	8.9	6371810	K 64 100
105	141	150	127	54	KB 6470, KB 6475	9.1	6372030	K 64 105
110	150	160	127	62	KB 6470, KB 6475	11.0	6372110	K 64 110
115	150	165	127	62	KB 6470, KB 6475	11.1	6372380	K 64 115
120	158	170	127	67	* KB 6470, KB 6475	12.0	6372460	K 64 120

## KB 6437 REDUCER 2.1/2" TO 1.1/2"

for impact sockets

- > Square drive as per DIN 3121, ISO 1174, Form F and H
- > GEDORE special steel, gun-metal finish



"	"	"	"	↳ mm ↳	↳ kg ↳	Code	No.
2.1/2	63	1.1/2	40	138	7.090	6699700	KB 6437

## KB 6470 - KB 6475 SAFETY RING AND SAFETY PIN

for impact sockets 2.1/2"



KB 6470



KB 6475

Description	∅	↳ mm ↳	↳ kg ↳	Code	No.
<b>Safety ring d 114 mm</b>	114		0.040	6699890	KB 6470
<b>Safety pin d 8 mm</b>	8	110	0.043	6699970	KB 6475

**Impact driver**

# K 1900

## HAND-OPERATED IMPACT DRIVER 1/2"

- > Particularly suitable for loosening tight bolts or screws with the aid of a hammer
- > Reversible for right and left hand operation
- > Will fit any 1/2" impact socket or bit
- > Manganese-phosphated

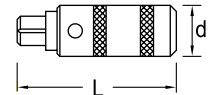

1/2"	12.5	L	d	kg	Code	No.
1/2	12.5	123	34	0.579	6654440	K 1900

# K 1900-018

## HAND-OPERATED IMPACT DRIVER SET 1/2"

18 pieces

- 12.5
- 1/2"
- 8
- 5/16"

- > Complete with the most frequently used bits, for use on screws and bolts with slotted, cross-head or hexagon heads
- > Reversible for right and left hand operation
- > In plastic case
- > Dimensions: 200 x 120 x 38 mm
- > TORX® = reg. trademark of Acument Intellectual Properties, LLC. USA



Contents	kg	Code	No.
⊖ 880 5,5 6,5 8 12	1.249	6654600	K 1900-018
● 885 4 5 6 8 10			
⊕ 890 2 3 4			
⊗ 887 TX T27 T30 T40 T45			
<b>KB 819</b>			
<b>K 1900</b>			

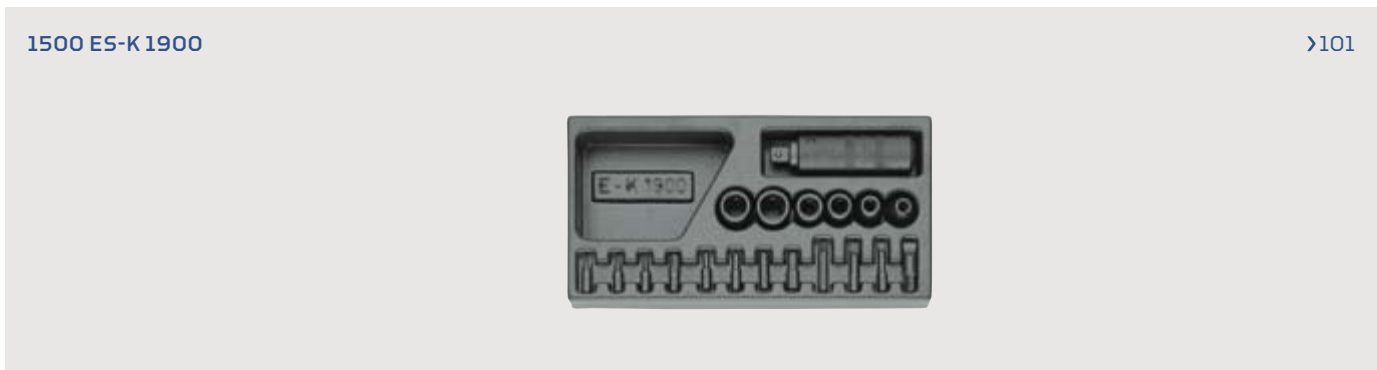

Bit range

# 690

## SCREWDRIVER BIT 1/4", VALUE PACK

**NEW**



for cross-head screws PH

- > For hand operation and use in electric and air tools
- > Acc. to DIN ISO 2351-2, tip as per DIN ISO 8764-1 PH
- > Hexagon drive as per DIN 3126 - C 6.3 (1/4")
- > GEDORE special vanadium steel, gun-metal finish
- > 10-piece value packs

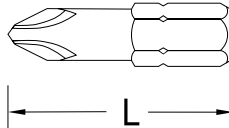

⊕ PH	L	Contents	⚖	Code	No.
0	25	10x	0.050	1803514	690 0 S-010
1	25	10x	0.050	6541240	690 1 S-010
1	50	10x	0.120	1828150	690 1 L S-010
2	25	10x	0.060	6541320	690 2 S-010
2	50	10x	0.120	6541400	690 2 L S-010
3	25	10x	0.060	6541590	690 3 S-010
3	50	10x	0.120	6541670	690 3 L S-010
4	32	10x	0.100	6541750	690 4 S-010

# 690 PZD

## SCREWDRIVER BIT 1/4", VALUE PACK

**NEW**



for cross-head screws Pozi PZ

- > For hand operation and use in electric and air tools
- > Acc. to DIN ISO 2351-2, tip as per DIN ISO 8764-1 PZ
- > Hexagon drive as per DIN 3126 - C 6.3 (1/4")
- > GEDORE special vanadium steel, gun-metal finish
- > 10-piece value packs

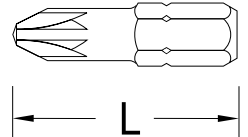

⊕ PZ	L	Contents	⚖	Code	No.
1	25	10x	0.050	6552790	690 PZD 1 S-010
1	50	10x	0.120	1827022	690 PZD 1 L S-010
2	25	10x	0.060	6552870	690 PZD 2 S-010
2	50	10x	0.120	6552950	690 PZD 2 L S-010
3	25	10x	0.060	6553090	690 PZD 3 S-010
3	50	10x	0.120	6553170	690 PZD 3 L S-010
4	32	10x	0.150	6553680	690 PZD 4 S-010

# 685

## SCREWDRIVER BIT 1/4", VALUE PACK



for in-hex screws

- > For hand operation and use in electric and air tools
- > Acc. to DIN ISO 2351-3
- > Hexagon drive as per DIN 3126 - C 6.3 (1/4")
- > GEDORE special vanadium steel, gun-metal finish
- > 10- and 5-piece value packs

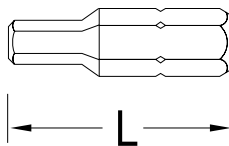

●	ISO 4762	DIN 7984	L	Contents	⚖	Code	No.
2	M2	M2	25	10x	0.050	1802399	685 2 S-010
2,5	M3	M4	25	10x	0.050	6538880	685 2,5 S-010
3	M4	M5	25	10x	0.050	6538960	685 3 S-010
4	M5	M6	25	10x	0.060	6539180	685 4 S-010
5	M6	M8	25	10x	0.060	6539260	685 5 S-010
6	M8	M10	25	10x	0.070	6539340	685 6 S-010
8	M10	M12	33	10x	0.090	6539420	685 8 S-010
10	M12	M14	33	5x	0.060	6539500	685 10 S-005

# 685 K

## SCREWDRIVER BIT 1/4", VALUE PACK



for in-hex screws, with ball end

- > For hand operation and use in electric and air tools
- > Hexagon drive as per DIN 3126 - C 6.3 (1/4")
- > GEDORE special vanadium steel, gun-metal finish
- > 5-piece value packs

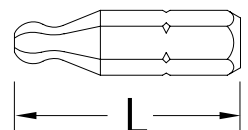

●	ISO 4762	DIN 7984	L	Contents	⚖	Code	No.
4	M5	M6	25	5x	0.030	2225700	685 K 4 S-005
5	M6	M8	25	5x	0.035	2225719	685 K 5 S-005
6	M8	M10	25	5x	0.040	2225727	685 K 6 S-005
8	M10	M12	33	5x	0.055	2225735	685 K 8 S-005
10	M12	M14	33	5x	0.070	2225743	685 K 10 S-005

## 687 TX SCREWDRIVER BIT 1/4", VALUE PACK

for recessed TORX® head screws

- > For hand operation and use in electric and air tools
- > Hexagon drive as per DIN 3126 - C 6.3 (1/4")
- > GEDORE special vanadium steel, gun-metal finish
- > 10-piece value packs
- > TORX® = reg. trademark of Acument Intellectual Properties, LLC. USA

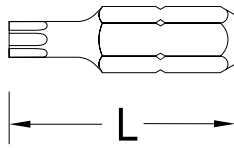

⊕	M	mm	L	Contents	kg	Code	No.
T6	M2	1,70	25	10x	0.050	6541830	687 TX T6 S-010
T7	M2,5	1,99	25	10x	0.050	6541910	687 TX T7 S-010
T8	M2,5	2,31	25	10x	0.050	6542050	687 TX T8 S-010
T9	M3	2,50	25	10x	0.050	6542130	687 TX T9 S-010
T10	M3 - M3,5	2,74	25	10x	0.050	6542210	687 TX T10 S-010
T15	M3,5 - M4	3,27	25	10x	0.050	6542480	687 TX T15 S-010
T20	M4 - M5	3,86	25	10x	0.050	6542560	687 TX T20 S-010
T25	M4,5 - M5	4,43	25	10x	0.060	6542640	687 TX T25 S-010
T27	M4,5 - M6	4,99	25	10x	0.060	6542720	687 TX T27 S-010
T30	M6 - M7	5,52	25	10x	0.060	6542800	687 TX T30 S-010
T40	M7 - M8	6,65	25	10x	0.070	6542990	687 TX T40 S-010

## 688 TX SCREWDRIVER BIT 1/4", VALUE PACK

for recessed TORX® head screws with pilot

- > For hand operation and use in electric and air tools
- > Hexagon drive as per DIN 3126 - C 6.3 (1/4")
- > GEDORE special vanadium steel, gun-metal finish
- > 10-piece value packs
- > TORX® = reg. trademark of Acument Intellectual Properties, LLC. USA

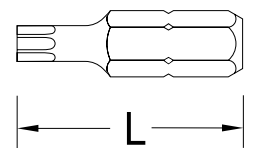

⊕	M	mm	L	Contents	kg	Code	No.
T10	M3 - M3,5	2,74	25	10x	0.050	6535510	688 TX T10 S-010
T15	M3,5 - M4	3,27	25	10x	0.050	6535780	688 TX T15 S-010
T20	M4 - M5	3,86	25	10x	0.050	6535860	688 TX T20 S-010
T25	M4,5 - M5	4,43	25	10x	0.060	6535940	688 TX T25 S-010
T27	M4,5 - M6	4,99	25	10x	0.060	6536080	688 TX T27 S-010
T30	M6 - M7	5,52	25	10x	0.060	6536160	688 TX T30 S-010
T40	M7 - M8	6,65	25	10x	0.060	6536240	688 TX T40 S-010

## 680 SCREWDRIVER BIT 1/4", VALUE PACK

for slotted head screws

- > For hand operation and use in electric and air tools
- > Acc. to DIN ISO 2351-1
- > Hexagon drive as per DIN 3126 - C 6.3 (1/4")
- > GEDORE special vanadium steel, gun-metal finish
- > 10- and 5-piece value packs

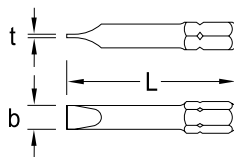

⊖	t	L	Contents	kg	Code	No.
4.0	0.5	25	10x	0.050	6537640	680 4 S-010
4.5	0.6	25	10x	0.050	6537720	680 4,5 S-010
5.5	0.8	25	10x	0.060	6537800	680 5,5 S-010
6.5	1.2	25	10x	0.060	6537990	680 6,5 S-010
7.0	1.2	25	10x	0.060	6538020	680 7 S-010
8.0	1.6	25	10x	0.070	6538100	680 8 S-010
10.0	1.6	39	5x	0.080	6538290	680 10 S-005

## 686 SCREWDRIVER BIT 1/4", VALUE PACK

for multi-spline screws RIBE®

- > For hand operation and use in electric and air tools
- > Hexagon drive as per DIN 3126 - C 6.3 (1/4")
- > GEDORE special vanadium steel, gun-metal finish
- > 10-piece value packs
- > RIBE® = reg. trademark of Richard Bergner GmbH & Co. KG, Schwabach, Germany

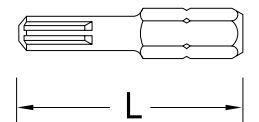

⊕	L	Contents	kg	Code	No.
M4	33	10x	0.060	6540510	686 4 S-010
M5	33	10x	0.070	6540780	686 5 S-010
M6	33	10x	0.080	6540860	686 6 S-010
M8	33	10x	0.110	6540940	686 8 S-010

## 685 X SCREWDRIVER BIT 1/4", VALUE PACK



for multi-point screws XZN

- > For hand operation and use in electric and air tools
- > Acc. to DIN ISO 65254
- > Hexagon drive as per DIN 3126 - C 6.3 (1/4"), tip as per DIN 2325
- > GEDORE special vanadium steel, gun-metal finish
- > 10-piece value packs

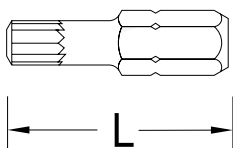

●	L	Contents	⚖️	Code	No.
M5	25	10x	0.060	6540000	685 X 5 S-010
M6	25	10x	0.060	6540190	685 X 6 S-010
M8	25	10x	0.080	6540270	685 X 8 S-010

## 689 TS SCREWDRIVER BIT 1/4" TORQ-SET®



- > For hand operation and use in electric and air tools
- > Acc. to DIN ISO 3126, ISO 1173
- > Hexagon drive as per DIN 3126 - C 6.3 (1/4")
- > GEDORE special vanadium steel, gun-metal finish
- > TORQ-SET® is a registered trademark of Phillips Screw Company, USA



Size	⚖️	Code	No.
2	0.006	1965506	689 TS 2
4	0.006	1965514	689 TS 4
6	0.006	1965522	689 TS 6
8	0.006	1965530	689 TS 8
10	0.006	1965549	689 TS 10

20 XLU-3 T

>164



### Bit sets 6.3 mm (1/4")

## 620-024 BIT SET 1/4"



24 pieces

- > In plastic case
- > Dimensions: 110 x 65 x 31 mm
- > TORX® = reg. trademark of Acument Intellectual Properties, LLC. USA

Bits	Accessories	⚖️	Code	No.
● 680 4 6,5	620	0.185	1815695	620-024
● 685 3 4 5 6				
● 685 X 5 6 8				
⊕ 690 1 2				
⊕ 690 PZD 1 2 3				
⊕ 687 TX T8 T9 T10 T15				
T20 T25 T27 T30 T40				



## Accessories for bits 6.3 mm (1/4")

### 671 BIT REVERSIBLE RATCHET 1/4"



- > With knurled head for quick starting or counter-holding of screws
- > Hex recess drive as per DIN 3126 - D 6.3 (1/4")
- > Slim line design for working in confined spaces
- > Return angle 15 degrees
- > Non-slip 2-component handle with hanging hole



Hex"	Hex	Angle	L mm	mm	kg	Code	No.
1/4	6.3	15	127	18.3	0.108	6535350	671

### 670 BIT SCREWDRIVER 1/4"



- > Hex recess drive as per DIN 3126 - D 6.3 (1/4"), for bits
- > Magnetic screw retainer
- > GEDORE vanadium steel

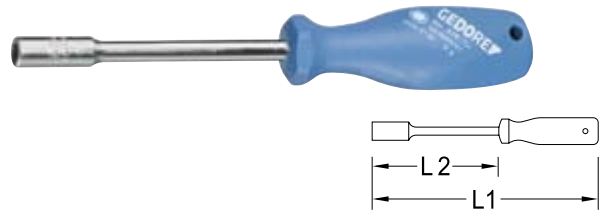

Hex"	Hex	L1	L2	kg	Code	No.
1/4	6.3	210	100	0.140	6536590	670

### 670 K BIT SCREWDRIVER 1/4"

short pattern

- > Hex recess drive as per DIN 3126 - D 6.3 (1/4"), for bits
- > Magnetic screw retainer
- > GEDORE vanadium steel



Hex"	Hex	L mm	kg	Code	No.
1/4	6.3	80	0.100	1953796	670 K



### 169 MAGAZINE HANDLE SCREWDRIVER



- > For highest demands
- > With 1/4" recessed hexagon drive
- > Magnetic magazine handle with room for 7 bits
- > Cap with click-locking



Hex"	Hex	Contents	L mm	L mm	kg	Code	No.
1/4	6.3	⊖ 680 4 5,5 6,5 ⊕ 690 1 2 ⊕ 690 PZD 1 2	115	220	0.206	6432700	169

### 674 BIT SCREWDRIVER

with reversible mechanism

- > Hexagon drive as per DIN 3126 - D 6.3 (1/4"), with powerful magnetic screw retainer
- > Smooth gear mechanism with knurled head for quick starting or counter-holding of screws
- > The blue handle makes it possible to tighten even hard-to-turn wood screws
- > The ratchet is reversible and fully lockable



Hex"	Hex	L mm	L mm	kg	Code	No.
1/4	6.3	55	215	0.259	6530710	674



### 676 DRIVING HANDLE

- > Non-slip 2-component handle
- > Recessed hexagon drive 1/4"
- > Versatile use



Hex"	Hex	kg	Code	No.
1/4	6.3	0.042	1649337	676

1500 CTD-20 BIT

>108





## 700 BIT HOLDER

magnetic

- > Quick-grip system for hex bits as per DIN 3126 - C 6.3 + E 6.3 (1/4")



Hex"	Hex	Hex"	Hex	Ø	Length mm	Weight kg	Code	No.
1/4	6.3	1/4	6.3	14	60.5	0.026	6530550	700

## 699 L BIT HOLDER LONG

long

- > Hexagon drive as per DIN 3126 - C 6.3 (1/4") and hex recess drive as per DIN 3126 - D 6.3 (1/4")
- > Hand operation
- > For use with driving handle, No. 676, or torque handle, No. 2140
- > With magnetic screw retainer



Hex"	Hex	Hex"	Hex	Length mm	Length mm	Weight kg	Code	No.
1/4	6.3	1/4	6.3	32	130	0.039	1802437	699 L

## 699 BIT HOLDER

for power tools

- > Acc. to DIN 7427 Form D
- > Hexagon drive as per DIN 3126 - E 6.3 (1/4") and hex recess drive as per DIN 3126 - D 6.3 (1/4")
- > With magnetic holder
- > Chrome-plated



Hex"	Hex	Hex"	Hex	Length mm	Length mm	Weight kg	Code	No.
1/4	6.3	1/4	6.3	30	60	0.023	6538610	699

## 673 L SOCKET HOLDER

long

- > 1/4" hexagon drive and square drive as per DIN 3120 - A 6.3 (1/4")
- > Hand operation
- > For use with driving handle no. 676, or torque handle no. 2140



Hex"	Hex	Hex"	Hex	Length mm	Weight kg	Code	No.
1/4	6.3	1/4	6.3	130	0.050	1811061	673 L

## 673 ADAPTOR

- > Acc. to DIN 7428, ISO 3317
- > Hexagon drive as per DIN 3126 - E 6.3 (1/4")
- > Square drive as per DIN 3121 for power-driven sockets
- > Also suitable for battery screwdrivers without impact effect



Hex"	Hex	Hex"	Hex	Length mm	Weight kg	Code	No.
1/4	6.3	1/4	6.3	50	0.016	6536320	673 6,3
3/8	10.0	1/4	6.3	50	0.026	1834878	673 10

## 673 K SOCKET HOLDER

short pattern

- > Hexagon drive as per DIN 3126 - E 6.3 (1/4")
- > Square drive as per DIN 3120 - A 6,3 (1/4")



Hex"	Hex	Hex"	Hex	Length mm	Weight kg	Code	No.
1/4	6.3	1/4	6.3	17	0.020	2000245	673 K

## 620 - 630 BIT ADAPTOR 1/4"

- > Hex recess drive as per DIN 3126 - D 6.3 (1/4") and square drive as per DIN 3120 - C 6.3 (1/4") / C 10 (3/8")



Hex"	Hex	Hex"	Hex	Length mm	Weight kg	Code	No.
1/4	6.3	1/4	6.3	25	0.020	1649329	620
1/4	6.3	3/8	10.0	25	0.025	1973312	630

## KB 619 - KB 630 ADAPTOR PIECES

for screwdriver bits 1/4"

- > Acc. to DIN 7427 Form A
- > Hex recess drive as per DIN 3126 - D 6.3 (1/4") and square drive Form G as per DIN 3121
- > For hand-operated or power tools
- > For use in power tools, we recommend the use of a locking ring and pin
- > Manganese-phosphated
- \* Length not standardised

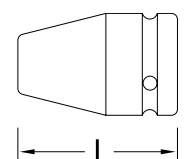

Hex"	Hex	Hex"	Hex	* L	Weight kg	Code	No.
1/4	6.3	1/2	12.5	35	0.072	6524150	KB 619
1/4	6.3	1/4	6.3	25	0.017	6524230	KB 620
1/4	6.3	3/8	10.0	* 30	0.040	6530040	KB 630

## 8 mm (5/16") hexagon drive

### 890 SCREWDRIVER BIT 5/16"



for cross-head screws PH

- > For hand operation and use in electric and air tools
- > For extra heavy use
- > Acc. to DIN ISO 2351-2, tip as per DIN ISO 8764-1 PH
- > Hexagon drive as per DIN 3126 - C 8 (5/16")
- > GEDORE special vanadium steel, gun-metal finish
- > Size 4: the length is not standardised

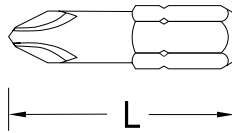

⊕ PH	L		Code	No.
1	32	0.010	6571580	890 1
2	32	0.010	6571660	890 2
3	32	0.010	6571740	890 3
4	32	0.012	6571820	890 4
4	38	0.015	6571900	890 4 L

### 890 PZD SCREWDRIVER BIT 5/16"



for cross-head screws Pozi PZ

- > For hand operation and use in electric and air tools
- > For extra heavy use
- > Acc. to DIN ISO 2351-2, tip as per DIN ISO 8764-1 PZ
- > Hexagon drive as per DIN 3126 - C 8 (5/16")
- > GEDORE special vanadium steel, gun-metal finish
- > Size 4: the length is not standardised

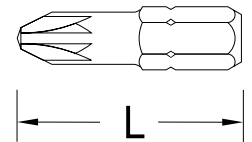

⊕ PZ	L		Code	No.
1	32	0.009	6553250	890 PZD 1
2	32	0.010	6553330	890 PZD 2
3	32	0.011	6553410	890 PZD 3
4	32	0.013	6553760	890 PZD 4

### 887 TX SCREWDRIVER BIT 5/16"



for recessed TORX® head screws

- > For hand operation and use in electric and air tools
- > For extra heavy use
- > Hexagon drive as per DIN 3126 - C 8 (5/16")
- > GEDORE special vanadium steel, gun-metal finish
- > TORX® = reg. trademark of Acument Intellectual Properties, LLC. USA

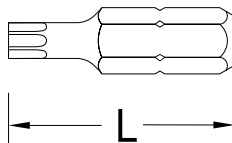

⊕			L		Code	No.
T27	M4,5 - M6	4,99	35	0.011	6571070	887 TX T27
T30	M6 - M7	5,52	35	0.012	6571150	887 TX T30
T40	M7 - M8	6,65	35	0.013	6571230	887 TX T40
T45	M8 - M10	7,82	35	0.014	6571310	887 TX T45
T50	M10	8,83	35	0.015	6575140	887 TX T50
T55	M12	11,22	35	0.021	2111225	887 TX T55

### 885 SCREWDRIVER BIT 5/16"



for in-hex screws

- > For hand operation and use in electric and air tools
- > For extra heavy use
- > Acc. to DIN ISO 2351-3
- > Hexagon drive as per DIN 3126 - C 8 (5/16")
- > GEDORE special vanadium steel, gun-metal finish

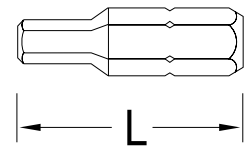

⊕	ISO 4762	DIN 7984	L		Code	No.
3	M4	M5	30	0.009	6568010	885 3
4	M5	M6	30	0.010	6568280	885 4
5	M6	M8	30	0.011	6568360	885 5
6	M8	M10	30	0.011	6568440	885 6
8	M10	M12	30	0.013	6568520	885 8
10	M12	M14	30	0.017	6568600	885 10

# 880 SCREWDRIVER BIT 5/16"

for slotted head screws

- > For hand operation and use in electric and air tools
- > For extra heavy use
- > Acc. to DIN ISO 2351-1
- > Hexagon drive as per DIN 3126 - C 8 (5/16")
- > GEDORE special vanadium steel, gun-metal finish

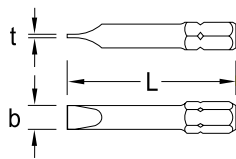

⊖	t	L	⚖	Code	No.
5.5	0.8	41	0.012	6566740	880 5,5
6.5	1.2	41	0.013	6566820	880 6,5
7.0	1.2	41	0.014	6566900	880 7
8.0	1.6	41	0.015	6567040	880 8
9.0	1.6	41	0.016	6567120	880 9
10.0	1.6	41	0.019	6567200	880 10
12.0	2.0	41	0.024	6567390	880 12
14.0	2.5	41	0.029	6567470	880 14

# 885 X SCREWDRIVER BIT 5/16"

for multi-point screws XZN

- > For hand operation and use in electric and air tools
- > For extra heavy use
- > Hexagon drive as per DIN 3126 - C 8 (5/16"), tip as per DIN 2325
- > GEDORE special vanadium steel, gun-metal finish

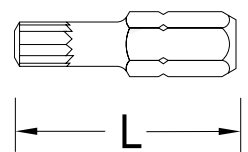

●	L	⚖	Code	No.
M5	28	0.009	6569170	885 X 5
M6	28	0.009	6569250	885 X 6
M8	28	0.011	6569330	885 X 8
M10	38	0.020	6569410	885 X 10
M12	38	0.025	6569680	885 X 12
M14	38	0.030	6569760	885 X 14

# 871 BIT REVERSIBLE RATCHET 5/16"

- > With knurled head for quick starting or counter-holding of screws
- > Hex recess drive as per DIN 3126 - D 8 (5/16")
- > Slim line design for working in confined spaces
- > Return angle 15 degrees
- > Non-slip 2-component handle with hanging hole



⊖"	⊖	∠°	↳ mm	mm	⚖	Code	No.
5/16	8	15	127	20.2	0.100	6535430	871

# KB 819 - KB 830 ADAPTOR PIECES

for screwdriver bits 5/16"

- > Acc. to DIN 7427 Form A
- > Hex recess drive as per DIN 3126 - D 8 (5/16") and square drive Form G DIN 3121
- > For hand-operated or power tools
- > For use in power tools, we recommend the use of a locking ring and pin
- > Manganese-phosphated
- \* Length not standardised

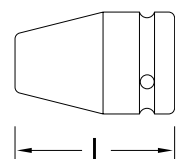

⊖"	⊖	⊖"	⊖	*	L	⚖	Code	No.
5/16	8	1/2	12.5		35	0.075	6563480	KB 819
5/16	8	1/4	6.3	*	25	0.018	6563560	KB 820
5/16	8	3/8	10.0		30	0.040	6563800	KB 830



# TORQUE TOOLS

DREMOMETER AM-F, A+S  
>268



ACCESSORIES  
DREMOMETER  
>281



DREMOMETER MINI / T-FS  
>282



DREMOMETER Z / SE, A+S  
>283



DREMASTER® K / UK / Z / SE  
>288



TORCOFIX K / Z / SE / FS  
>294



TORQUE SCREWDRIVERS  
>299



OTHER MECHANICAL  
TORQUE WRENCHES  
>304



ELECTRONIC TORQUE  
WRENCHES  
TORCOTRONIC  
>312



TORQUE CALIBRATION  
ANALYSER DREMOTEST E  
>314



ELECTRONIC TORSION  
TEST DEVICE E-TP  
>315



ACCESSORIES  
END FITTINGS  
>317



TORQUE MULTIPLIERS  
DREMOPLUS ALU  
>329



DETAILED INFORMATION ON  
CALIBRATION AND REPAIR  
>636



# TORQUE COMPETENCE FROM 0.02 TO 54,000 N·M

## Maximum production depth from a single source

- > Use of the very best steel grades, state-of-the-art machinery and environmentally-friendly production processes
- > Our tool experts guarantee precision-like processing and permanent development
- > Precise adherence to stringent testing and measuring specifications are proof of maximum product quality.
- > Large selection of mechanical and electronic torque wrenches, test equipment, torque multipliers and accessories
- > Available individually or in practical sets
- > Tailored service packages through to development of special customised tools

## Maximum control during production guarantees a constantly high level.

- > All parts incorporated in the production process - from steel to the smallest spring - are controlled while all manufacturing and work steps are subject to stringent quality controls.
- > After assembly, adjustment and calibration, torque tools are tested for accuracy in the end control stage and given a serial number (unique product identification) and factory test certificate in accordance with the applicable DIN EN ISO standard.
- > Within the framework of regular continuous tests, processing quality, repeat accuracy and durability are tested. The results of these tests are integrated directly in optimising the production process.

## Controlled screw tightening - reliable and safe for more than 50 years

- > Top-grade industrial quality for the hardest of continuous uses
- > Torque tools are measuring equipment. Over the long term, the high accuracy can only be assured in the form of regular tests (recalibration, recommended once a year or after 5000 load cycles)

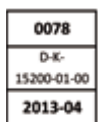

## Top-level authorised calibration and competent control

- > Own accredited DAkkS calibration laboratory for torques with (licence for testing in acc. with DAkkS guidelines DKD 3-7/3-8/DIN EN ISO 6789:2003) the registration number: D-K-15200-01-00
- > National co-operation partner to the German Calibration Service (DAkkS) since accreditation (DIN EN ISO/IEC 17025) and authorisation by PTB in 2000
- > Official examination of all test and measuring equipment once a year in the DAkkS laboratory by the Physikalisch-Technische Bundesanstalt in Braunschweig (PTB)
- > Internal precision testing of all test and measuring equipment at least once every 3 months

## Our all-round service - qualified and customised

We offer you a wide range of services, which can be matched quite individually to your requirements. Your problems are our challenges. We can offer you qualified tailormade support in the following areas:

- > In-house calibration according to DIN EN ISO 6789:2003
- > DAkkS calibration in our own accredited DAkkS calibration laboratory
- > Repair service for our own brands
- > Demonstration/hire tools at favourable prices
- > Competent advice via our service telephone
- > Problem solving with the aid of our technical field service
- > Product training (internal and external)
- > Product presentations (internal and external)
- > Involvement in your in-house fairs
- > Special solutions in the engineering field/GEDORE SOLUTIONS



# CERTIFIED PRECISION

Traceable  
safety

- > DAKKS calibration in our own accredited, independent DAKKS calibration laboratory
- > In-house calibration according to DIN EN ISO 6789:2003

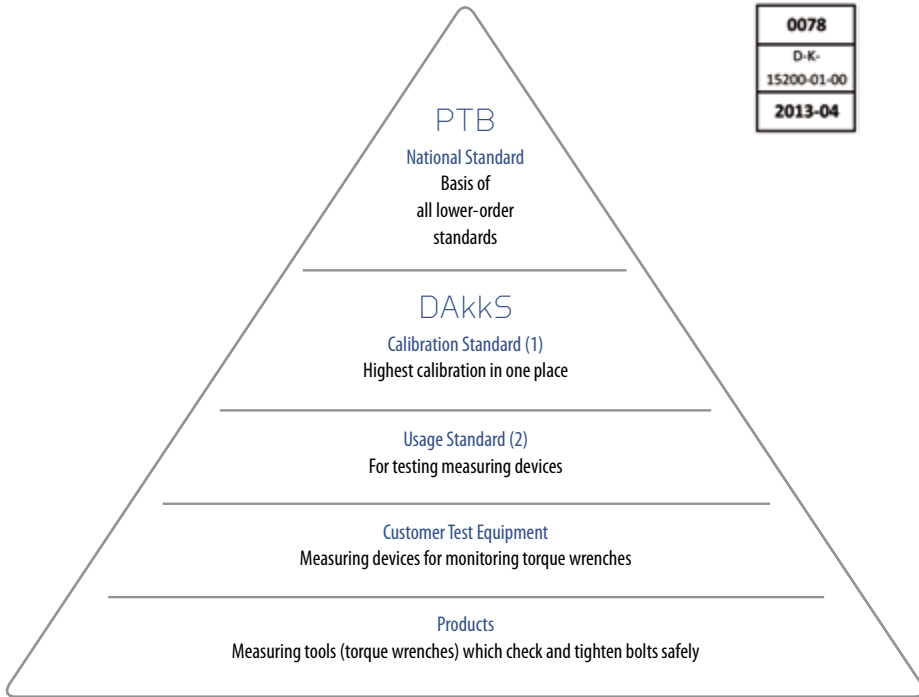

**GEDORE Werkzeugfabrik**  
GEDORE Co. KG  
Rheinländer Straße 140  
42699 Solingen • GEDORE

**Vertrieb DEUTSCHLAND**  
Tel: +49 210 536 910  
Rheinländer Straße 140  
42699 Solingen • GEDORE

**Sales INTERNATIONAL**  
Tel: +49 210 536 910  
Rheinländer Straße 140  
42699 Solingen • GEDORE

**GEDORE**  
WERKZEUGE FÜR ALLEN

**Kalibrier - Zertifikat / Calibration Certificate**

Objekt: Drehmoment  
Anzahl der / Part number: DAK 300 DREHMOMENTEN  
Messbereich / Measuring range: 0,2 - 3000 N-m  
Genauigkeit / Accuracy: 0,2 %  
Normen / Standards: DIN EN ISO 6789:2003  
Serien-Nr. / Serial number: M202008  
Kalibrierlabor / Calibration laboratory: DAK 15200-01-00  
Kalibrierdatum / Calibration date: 08.07.2014

Prüfung / Testing	Art	0,2 N-m	10 N-m	100 N-m	1000 N-m	3000 N-m
1. Prüfung - Measuring	99,4	-0,01 %	100,0	-0,01 %	100,0	-0,01 %
2. Prüfung - Measuring	99,5	-0,01 %	100,0	-0,01 %	100,0	-0,01 %
3. Prüfung - Measuring	99,5	-0,01 %	100,0	-0,01 %	100,0	-0,01 %
4. Prüfung - Measuring	99,5	-0,01 %	100,0	-0,01 %	100,0	-0,01 %
5. Prüfung - Measuring	99,5	-0,01 %	100,0	-0,01 %	100,0	-0,01 %
Wiederholbarkeit / Repeatability	%	0,10	0,10	0,10	0,10	0,10
Wiederholbarkeit / Repeatability	N-m	0,2	10	100	1000	3000

Das Prüfergebn wurde auf keine nachvollziehbare Weise verändert.  
All the results in this certificate are in accordance with the 2003 version of **DIN EN ISO 6789:2003**.  
The accuracy of the results on the testing machine is assured by identification from accredited DAKS Calibration (DAK 15200-01-00).

Das Prüfergebn wurde nach **DIN EN ISO 6789:2003** durchgeführt.  
Testing procedures are in accordance with the 2003 version of **DIN EN ISO 6789:2003**.  
The accuracy of the results on the testing machine is assured by identification from accredited DAKS Calibration (DAK 15200-01-00).

Das Prüfergebn wurde auf keine nachvollziehbare Weise verändert.  
All the results in this certificate are in accordance with the 2003 version of **DIN EN ISO 6789:2003**.  
The accuracy of the results on the testing machine is assured by identification from accredited DAKS Calibration (DAK 15200-01-00).

Das Prüfergebn wurde nach **DIN EN ISO 6789:2003** durchgeführt.  
Testing procedures are in accordance with the 2003 version of **DIN EN ISO 6789:2003**.  
The accuracy of the results on the testing machine is assured by identification from accredited DAKS Calibration (DAK 15200-01-00).

**0078**  
**D-K**  
**15200-01-00**  
**2013-04**

**GEDORE**  
WERKZEUGE FÜR ALLEN

akkreditiert durch die / accredited by the  
**Deutsche Akkreditierungsstelle GmbH**  
als Kalibrierlaboratorium für / as calibration laboratory in the  
**Deutschen Kalibrierdienst** **DKD**

Kalibrierlabor / Calibration lab: DAK 15200-01-00

Objekt: Drehmoment  
Hersteller: GEDORE TorqueTool GmbH  
Modellnummer: 300100  
Typ: 4000 00  
Teil: 4000 00  
Kalibrierlabor No.: 1520001 / 1520002  
Ort: Solingen  
Auftraggeber: Wirtgen Maschinen GmbH  
Prüfdatum: 08.07.2014  
Auftragnummer: 0078/14  
Anzahl der Seiten des Kalibrierzertifikates: 1  
Number of pages of the certificate: 1  
Status der Kalibrierung: 10.04.2013  
Date of calibration: 10.04.2013

Dieses Kalibrierzertifikat ist ein verbindliches und unveränderliches Dokument. Jegliche nachfolgenden Änderungen der Beschriftung werden durch die Deutsche Akkreditierungsstelle GmbH als nicht zum Kalibrierzertifikat gehörend betrachtet. Kalibrierzertifikate dürfen nicht kopiert, verändert oder in anderer Weise missbraucht werden.  
This calibration certificate is a binding and unchangeable document. Any subsequent changes to the labeling will be considered as not belonging to the calibration certificate. Calibration certificates may not be copied, changed or misused in any other way.

Dieses Kalibrierzertifikat ist ein verbindliches und unveränderliches Dokument. Jegliche nachfolgenden Änderungen der Beschriftung werden durch die Deutsche Akkreditierungsstelle GmbH als nicht zum Kalibrierzertifikat gehörend betrachtet. Kalibrierzertifikate dürfen nicht kopiert, verändert oder in anderer Weise missbraucht werden.  
This calibration certificate is a binding and unchangeable document. Any subsequent changes to the labeling will be considered as not belonging to the calibration certificate. Calibration certificates may not be copied, changed or misused in any other way.

**INFO** > 636

More information on the topics calibration types, certificates and repair service

## DAKKS-CALIBRATION

















































Scope of services offered by DAKKS Laboratory [1]

Type	Measuring range	Measuring process	Minimum measurement inaccuracy indicated
Electr. torque wrench	0,2 N-m – 3.000 N-m	DAKKS – DKD – R 3 – 7:2003	0,2 %
Calibration equipment torque wrench (test devices)	0,2 N-m – 3.000 N-m	DAKKS – DKD – R 3 – 8:2003	0,2 %
Hand-operated torque wrench	0,2 N-m – 1.000 N-m	DIN EN ISO 6789:2003	1 %

Factory calibration [2]

Type	Measuring range	Measuring process	Minimum measurement inaccuracy indicated
Electr. torque wrench	0,2 N-m – 3.000 N-m	DIN EN ISO 6789:2003	1 %
Calibration equipment torque wrench (test devices)	0,2 N-m – 3.000 N-m	based on DAKKS-DKD 3-8:2003	0,5 %
Hand-operated torque wrench	0,2 N-m – 1.000 N-m	DIN EN ISO 6789:2003	1 %
Electr. torque/rotary angle wrench	5 N-m – 300 N-m	VDI 2647	0,3°
		based on VDI 2648	0,5°
		Homologation acc. OEM	0,3°

# OVERVIEW OF GEDORE TORQUE TOOLS

Page	Series/Type	Precision +/-	Drive	Ratchet	Scale	Operation length independent	Release types
<b>0,4 – 3.000 N-m Mechanische Drehmomentschlüssel</b>							
282	Dremometer Mini 	3%	1/4"	<input type="checkbox"/>	<input checked="" type="checkbox"/>	<input checked="" type="checkbox"/>	① 
268	Dremometer AM - F 	3%	1/4" ▶ 1/2"	<input type="checkbox"/>	<input checked="" type="checkbox"/>	<input checked="" type="checkbox"/>	① 
283	Dremometer Z 	3%	16 22 28	<input type="checkbox"/>	<input checked="" type="checkbox"/>	<input type="checkbox"/>	① 
284	Dremometer SE 	3%	9x12 14x18	<input type="checkbox"/>	<input checked="" type="checkbox"/>	<input type="checkbox"/>	① 
282	Dremometer FS 	6%	1/4"	<input type="checkbox"/>	<input type="checkbox"/>	<input checked="" type="checkbox"/>	① 
290	Dremometer DMK 	3%	1/2" ▶ 3/4"	<input type="checkbox"/>	<input checked="" type="checkbox"/>	<input type="checkbox"/>	① 
291	Dremometer DMUK 	3%	1/2"	<input checked="" type="checkbox"/>	<input checked="" type="checkbox"/>	<input type="checkbox"/>	① 
292	Dremometer DMZ 	3%	16 22	<input type="checkbox"/>	<input checked="" type="checkbox"/>	<input type="checkbox"/>	① 
293	Dremometer DMSE 	3%	9x12 14x18	<input type="checkbox"/>	<input checked="" type="checkbox"/>	<input type="checkbox"/>	① 
295	Torcofix K 	3%	1/4" ▶ 3/4"	<input type="checkbox"/>	<input checked="" type="checkbox"/>	<input type="checkbox"/>	① 
296	Torcofix Z 	3%	16 22	<input type="checkbox"/>	<input checked="" type="checkbox"/>	<input type="checkbox"/>	① 
297	Torcofix SE 	3%	9x12 14x18	<input type="checkbox"/>	<input checked="" type="checkbox"/>	<input type="checkbox"/>	① 
298	Torcofix FS 	3%	9x12 14x18	<input type="checkbox"/>	<input type="checkbox"/>	<input type="checkbox"/>	① 
305	TSN Slipper 	4%	1/4" ▶ 1/4"	<input checked="" type="checkbox"/>	<input type="checkbox"/>	<input checked="" type="checkbox"/>	③ 
308	TBN Knicker 	4%, 6%	16 9x12	<input type="checkbox"/>	<input type="checkbox"/>	<input type="checkbox"/>	② 
306	TSP Slipper 	6%	1/4" ▶ 1/2"	<input checked="" type="checkbox"/>	<input type="checkbox"/>	<input checked="" type="checkbox"/>	③ 
306	TSC Slipper 	6%	1/4"	<input checked="" type="checkbox"/>	<input checked="" type="checkbox"/>	<input checked="" type="checkbox"/>	③ 
310	Typ 83 	4%	1/4" ▶ 1"	<input checked="" type="checkbox"/>	<input type="checkbox"/>	<input checked="" type="checkbox"/>	
309	Typ 88 	4%	3/4" 22	<input checked="" type="checkbox"/>	<input checked="" type="checkbox"/>	<input type="checkbox"/>	② 
<b>0,04 – 13,6 N-m Torque screwdriver</b>							
301	Typ 755 FS 	6%	1/4"	<input checked="" type="checkbox"/>	<input checked="" type="checkbox"/>	<input type="checkbox"/>	③ 
302	Typ 756 S 	6%	1/4"	<input type="checkbox"/>	<input checked="" type="checkbox"/>	<input type="checkbox"/>	③ 
303	Typ 757 S 	6%	1/4"	<input type="checkbox"/>	<input checked="" type="checkbox"/>	<input type="checkbox"/>	③ 
303	Typ 758 SP 	6%	1/4"	<input type="checkbox"/>	<input checked="" type="checkbox"/>	<input type="checkbox"/>	
<b>2 – 1.000 N-m Electr. torque wrench</b>							
312	E-Torc II 	1%	1/4"	<input checked="" type="checkbox"/>	<input checked="" type="checkbox"/>	<input type="checkbox"/>	
313	Torcotronic III 	1%	1/2"	<input checked="" type="checkbox"/>	<input checked="" type="checkbox"/>	<input type="checkbox"/>	
<b>0,2 – 3.150 N-m Torque testers</b>							
314	Dremotest E 	1%	1/4" ▶ 1/2"	<input type="checkbox"/>	<input type="checkbox"/>	<input type="checkbox"/>	
315	E-TP 	1%	1/4" ▶ 1/2"	<input type="checkbox"/>	<input type="checkbox"/>	<input type="checkbox"/>	

Range N·m

0 5 10 15 20 40 60 80 100 150 200 300 400 500 750 1000 1500 2000

**Mech. torque wrench**

2,5 – 12 N·m
6 – 3.000 N·m
8 – 1.000 N·m
8 – 400 N·m
5 – 12 N·m
20 – 850 N·m
20 – 300 N·m
20 – 850 N·m
20 – 400 N·m
1 – 850 N·m
2 – 850 N·m
2 – 400 N·m
2 – 200 N·m
5 – 125 N·m
0,4 – 135 N·m
1 – 10 N·m
1 – 10 N·m
0,8 – 2.000 N·m
100 – 1.500 N·m

**Torque screwdriver**

0,04 – 13,6 N·m
0,08 – 9 N·m
0,2 – 9 N·m
0,1 – 5,0 N·m

**Electr. torque wrench**

2 – 1.000 N·m
10 – 350 N·m

**Torque testers**

0,2 – 3.150 N·m
0,5 – 3.150 N·m

Different Torque Tool Mechanisms

① **Click Tools**  
Overtightening Possible

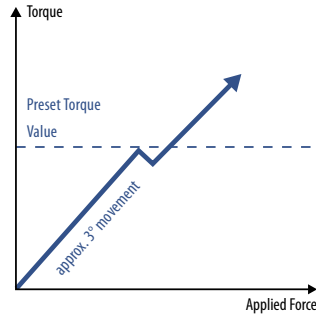

When the preset torque value is reached the operator will hear a click, feel an impulse and there will be approximately 3° of tool movement. Resetting takes place when the hand pressure is released. Work can then immediately continue. These tools are generally length dependent (exception DREMOMETER models AM - F), the position of the hand on the tool alters the torque produced. Continued application of force after the 3° of movement will cause the torque applied to increase above the required preset limit.

② **Breaking Tools**  
Overtightening Unlikely

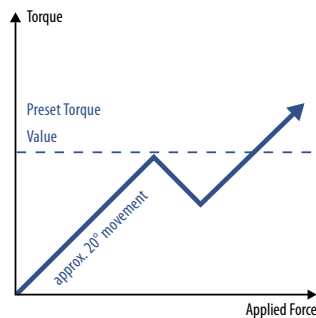

When the preset torque value is reached, these tools break at a specific point along the tool's length - usually at a pivot point near the tool's head. In most cases the movement is approximately 20°. The tool is automatically reset by allowing the handle to return to its in line position. These tools are length dependent, the position of the hand on the tool alters the torque produced. Continued application of force after 20° of tool movement will increase the torque applied above the preset limit but with the greater angle of tool movement this is less likely.

③ **Slipping Tools**  
Overtightening Impossible

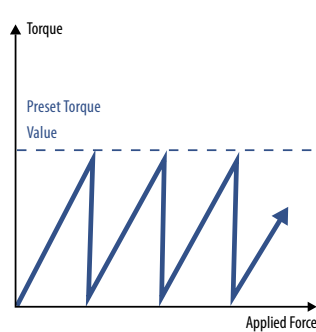

When the preset torque value is reached, a mechanism in the tool causes the application of torque to cease and the tool slips free for a short time until resetting occurs. Even if the application of force is repeated, the preset torque value will not be exceeded, therefore making it impossible to overtighten a fastener. These tools are not length dependent.

# DREMOMETER PERMANENT PRECISION

Torque wrench made of high-strength aluminium alloy



### Drive in accordance with application

DREMOMETERS are available for a large variety of applications in controlled screw tightening. The single square drive (L) for controlled clockwise tightening or the double square drive (L) for controlled bi-directional tightening. Special utilisation areas for DREMOMETER with spigot end (Z) and rectangular cavity (SE) particularly for hard-to-access locations and where space is tight. Almost all DREMOMETER models have separate ratchet heads, and there are good reasons for that: It is possible to work with or without the ratchet head function as desired.



### Robust and unsusceptible

The full-metal construction of the DREMOMETER makes it particularly unsusceptible to grime and rough handling on construction sites, in workshops and in industry.

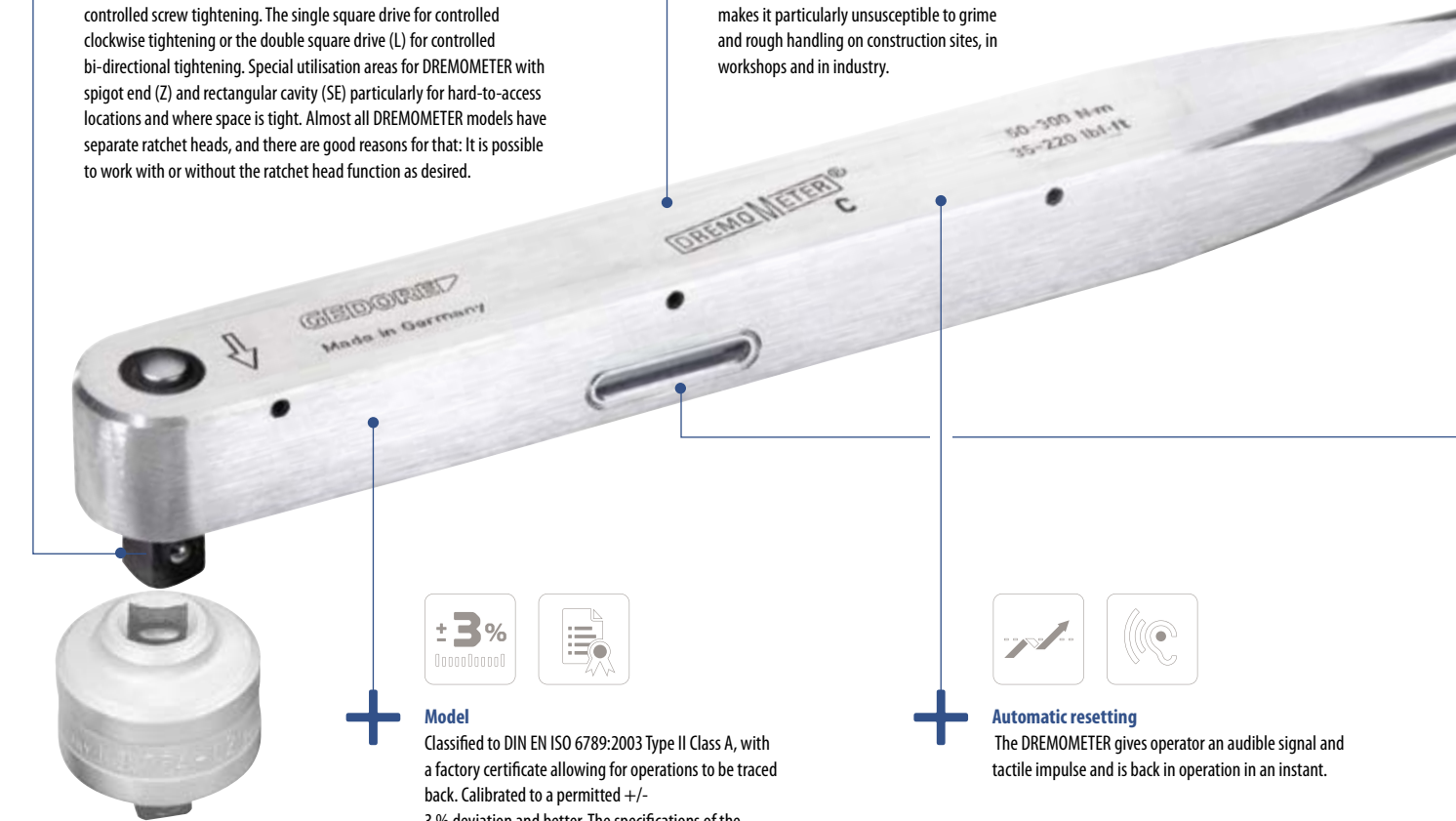

### Model

Classified to DIN EN ISO 6789:2003 Type II Class A, with a factory certificate allowing for operations to be traced back. Calibrated to a permitted +/- 3% deviation and better. The specifications of the standard (+/- 4%) are exceeded.



### Automatic resetting

The DREMOMETER gives operator an audible signal and tactile impulse and is back in operation in an instant.



$\square$  1/4 - 1/2 6-3000 N·m



$\square$  L 1/4 - 1 6-2000 N·m



Z 16 22 28 8-1000 N·m



SE 9x12 14x18 8-400 N·m

## **i** Working principle

The quality lever chain produced in the company's own drop forge reduces the strain on the mechanics to a minimum. The proportioning of the individual levers, which are optimally attuned to each other, gives the DREMOMETER its unique precision and its long tool life.

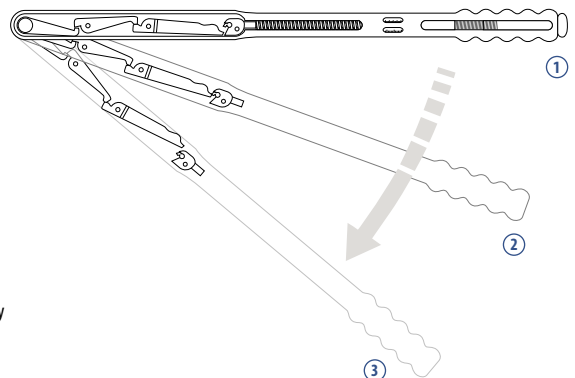

- ① Position of the lever chain without impact of force (in starting position).
- ② Position of the lever chain with impact of force before the set torque is achieved. The force is transferred from the primary lever to the intermediary and final lever until the final lever slips past the so-called release lever through the sliding back of the angle-lever body.
- ③ Position of the lever chain when the force impacts after the torque setting is achieved. Immediate position after the clear tactile impulse and audible signal "click". On relief, the lever chain moves back into the starting position (1).

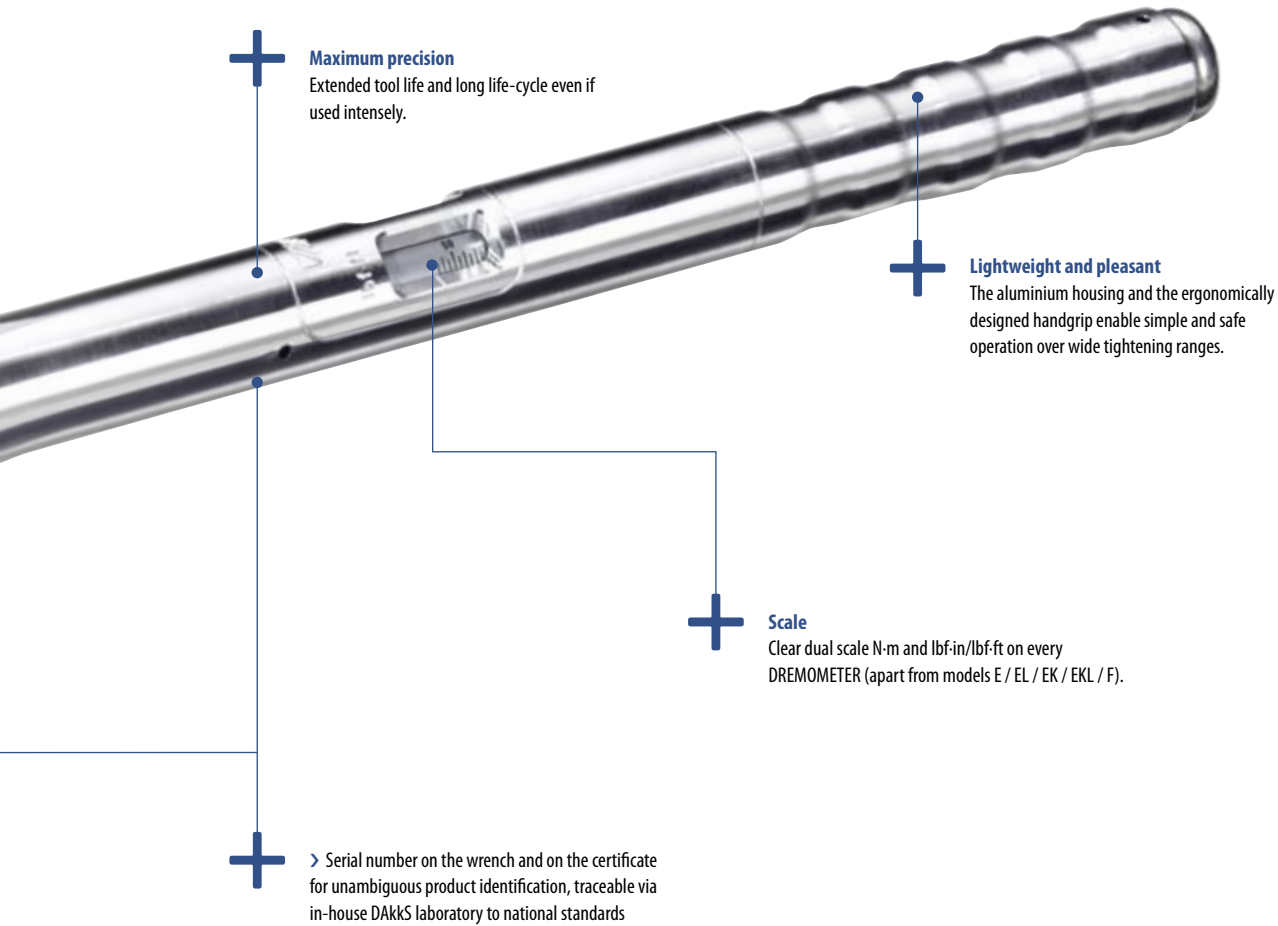

## DREMOMETER

### Operable without inaccuracies

Regardless of where you apply the force, at the center of the handgrip or another part of the DREMOMETER, with both hands or using an extension tube, your torque setting will always be attained, without shifts in value. Due to its unique single-axis location of the centre of rotation and the output square drive, the DREMOMETER is a tool that can be operated free from errors. In contrast to conventional torque wrenches, this single lever enables tightening without shifts in the measured value and without interference caused by activation outside of the handgrip.

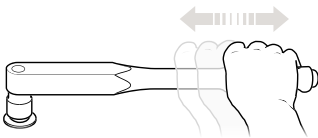

However, value shifts are possible when activating the DREMOMETER with special wrenches or when using wrenches with different depth gauges.

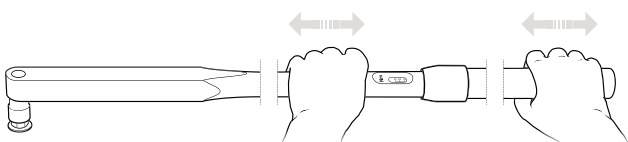

## Features

Setting of the torque value to N-m or alternatively to lbf-in / lbf-ft by the non-losable hexagon key in the handgrip. The smooth-running mechanism enables the setting to be made quickly without significant force needing to be applied.

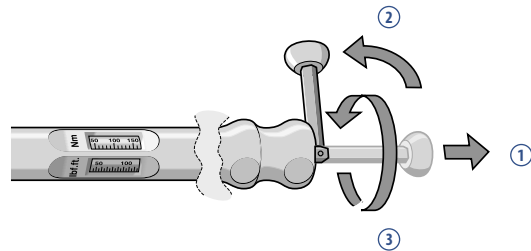

All DREMOMETERS are also available with locking and safety device (A+S). Pre-set value locking and safety device (A+S) eliminates the possibility of unintentional or manipulated adjustment, thereby representing more process reliability of the user

# DREMOMETER THE ORIGINAL

Lightweight and sturdy, very workshop-friendly  
Maximum precision even when subjected to extreme  
continuous use.

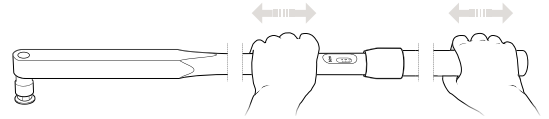

Drive	Range N-m
6.3	6 – 30 N-m
1/4	AM / AML
10	8 – 40 N-m
3/8	A / AL
12.5	25 – 120 N-m
1/2	B / BL
Type B, Bc, C with push-button release	40 – 200 N-m
	BC / BCL
	60 – 300 N-m
	C / CL
20	80 – 360 N-m
3/4	CD / CDL
	110 – 550 N-m
	DS / DSL
	155 – 760 N-m
	D / DL
	DR / DRL
	520 – 1.000 N-m
	DX / DXL
25	600 – 1.500 N-m
1	EK / EKL
	750 – 2.000 N-m
	E / EL
40 1 1/2	F
	1.500 – 3.000 N-m





## All the benefits at a single glance

### Square drive

- > In the DREMOMETER, the output square drive and the pivot point of the primary lever are situated on a single axis.
- > Advantage: The absolute accuracy always remains unchanged in every case. Even if the tool is operated outside of the handgrip or with an extension tube.
- > This ensures a high degree of user safety; can be extended to reduce the user's working load.

### Lever chain

- > The integrated lever chain reduces the strain on the measuring mechanics to a minimum which means that the measuring mechanics can thus be constructed with much greater sensitivity.
- > Advantage: High accuracy and a long life cycle.
- > Extremely low wear

### Double square drive

- > DREMOMETER models (except model F) having a double square drive are available on request. Apart from that, separate ratchet heads are available for almost all models (except model F).
- > Advantage: Controlled counter-clockwise tightening and work in very narrow spaces are possible without any problems.

### Scale

- > Two scales on each DREMOMETER indicate N-m and the common US unit of torque measurement (apart from types E - F).
- > Advantage: Exact reading even for lbf-in or lbf-ft.
- > Easy operation - fast and safe torque tightening

### Handgrip

- > The nice-to-hold handgrip enables safe work and less operator fatigue. The full-metal construction makes DREMOMETER models particularly robust.
- > Advantage: A high level of dependability even following tough long term work.

### Test certificate

- > All DREMOMETER models include a test certificate according to DIN EN ISO 6789:2003.
- > Advantage: Guaranteed accuracy +/- 3 % of the adjusted scale value. The specification of the standard (+/- 4 %) is exceeded.

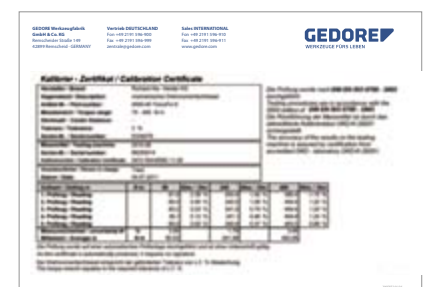

Type	N-m	lbf-in	lbf-ft	Scale	Tube	Code	No.
AM	6 – 30	50 – 270	–	1 N-m / 10 lbf-in	–	7775440	8554-01
AML	6 – 30	50 – 270	–	1 N-m / 10 lbf-in	–	7775870	8559-01
A	8 – 40	70 – 350	–	5 N-m / 50 lbf-in	–	7682000	8560-01
AL	8 – 40	70 – 350	–	5 N-m / 50 lbf-in	–	7682190	8565-01
B	25 – 120	–	18 – 90	5 N-m / 5 lbf-in	–	7683320	8561-01
BL	25 – 120	–	18 – 90	5 N-m / 5 lbf-in	–	7683400	8566-01
BC	40 – 200	–	30 – 150	5 N-m / 5 lbf-in	–	7685530	8573-01
BCL	40 – 200	–	30 – 150	5 N-m / 5 lbf-in	–	7683670	8578-00
C	60 – 300	–	45 – 220	5 N-m / 5 lbf-in	–	7685450	8562-10
CL	60 – 300	–	45 – 220	5 N-m / 5 lbf-in	–	7685960	8567-10
CD	80 – 360	–	60 – 260	5 N-m / 5 lbf-in	–	7688470	8570-10
CDL	80 – 360	–	60 – 260	5 N-m / 5 lbf-in	–	7688710	8575-10
DS	110 – 550	–	80 – 400	10 N-m / 10 lbf-in	–	1427156	8574-10
DSL	110 – 550	–	80 – 400	10 N-m / 10 lbf-in	–	1427121	8579-10
D	155 – 760	–	115 – 560	10 N-m / 10 lbf-in	–	7691500	8563-10
DL	155 – 760	–	115 – 560	10 N-m / 10 lbf-in	–	7691850	8568-10
DR	155 – 760	–	115 – 560	10 N-m / 10 lbf-in	8571-80	7670180	8563-01
DRL	155 – 760	–	115 – 560	10 N-m / 10 lbf-in	8571-80	7670500	8568-01
DX	520 – 1.000	–	380 – 730	10 N-m / 10 lbf-in	8571-80	7694010	8571-01
DXL	520 – 1.000	–	380 – 730	10 N-m / 10 lbf-in	8571-80	7694360	8576-01
EK	600 – 1.500	–	–	25 N-m	8564-92	2311267	8581-01
EKL	600 – 1.500	–	–	25 N-m	8564-92	2311291	8586-01
E	750 – 2.000	–	–	50 N-m	8564-92 / 8572-74	7695250	8564-01
EL	750 – 2.000	–	–	50 N-m	8564-92 / 8572-74	7695410	8569-01
F	1.500 – 3.000	–	–	50 N-m	8564-92 / 8572-74	7717160	8572-01



# Torque Tools

## 8554 AM - 8559 AML TORQUE WRENCH DREMOMETER

6-30 N·m / 50-270 lbf·in

**Use:**

- > Controlled screw tightening in the range 6-30 N·m / 50-270 lbf·in
- > For use in almost all industrial manufacturing areas

**Features:**

- > Classified to DIN EN ISO 6789:2003 Type II Class A, with a factory certificate. Working accuracy: +/- 3% tolerance of scale set torque. The specification of the standard (+/- 4%) is exceeded.
- > 1/4" square drive with ball locking device DIN 3120 - A 6.3 ISO 1174
- > Automatic short-path actuation with tactile impulse and audible signal
- > Dual scale with a scale graduation of 1 N·m and 10 lbf·in

**Technical advantage/Function:**

- > Lightweight and robust (as housing is made of an aluminium alloy), very workshop-friendly
- > No inaccuracies whether used with both hands or held away from the handle (as for standard torque wrenches). Both the square drive and fulcrum are on an axis which ensures a high degree of user safety; can be extended to reduce the user's working load.
- > Extremely low wear attributable to reduced forces in a unique lever mechanism
- > Forged lever chain from our own quality forge
- > Maximum precision even when subjected to extreme continuous use
- > Long life cycles and tool lives
- > Easy operation - fast and safe torque tightening
- > Easy adjustment thanks to attractive adjusting button secured against loss at the end of the handle
- > Single- and double-square drive for controlled bi-directional tightening



AM



8554-03

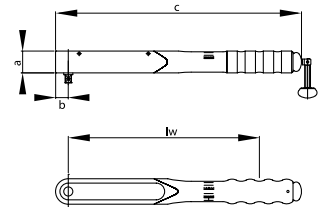

Type	1/4"	6.3	Contents	N·m	lbf·in	lw	a	b	c	1 N·m / 10 lbf·in	0.580	Code	No.
AM	1/4	6.3	in plastic box	6-30	50-270	206	30	15	268	1 N·m / 10 lbf·in	0.580	7775440	8554-01
AM	1/4	6.3	in plastic cassette	6-30	50-270	206	30	15	268	1 N·m / 10 lbf·in	0.910	7674090	8554-02
AM	1/4	6.3	Set mm ○ 8 9 10 11 12 13 14 ⊕ 3 ⊖ 5.5 ⊙ 4 5 6 8 ● T20 T27 T30 ⊕ 754-00 ← 55 + 97 mm	6-30	50-270	206	30	15	268	1 N·m / 10 lbf·in	1.300	7674170	8554-03
AM	1/4	6.3	Set INCH ○ 9/32 5/16 11/32 3/8 7/16 1/2 9/16 ⊕ 3 ⊖ 5.5 ⊙ 4 5 6 8 ● T20 T27 T30 ⊕ 754-00 ← 55 + 97 mm	6-30	50-270	206	30	15	268	1 N·m / 10 lbf·in	1.300	7674410	8554-04
AML	1/4	6.3	in plastic box	6-30	50-270	206	30	15	268	1 N·m / 10 lbf·in	0.580	7775870	8559-01
AML	1/4	6.3	in plastic cassette	6-30	50-270	206	30	15	268	1 N·m / 10 lbf·in	0.910	7673790	8559-02
AML	1/4	6.3	Set mm ○ 8 9 10 11 12 13 14 ⊕ 3 ⊖ 5.5 ⊙ 4 5 6 8 ● T20 T27 T30 ⊕ 754-00 ← 55 + 97 mm	6-30	50-270	206	30	15	268	1 N·m / 10 lbf·in	1.300	7675060	8559-03
AML	1/4	6.3	Set INCH ○ 9/32 5/16 11/32 3/8 7/16 1/2 9/16 ⊕ 3 ⊖ 5.5 ⊙ 4 5 6 8 ● T20 T27 T30 ⊕ 754-00 ← 55 + 97 mm	6-30	50-270	206	30	15	268	1 N·m / 10 lbf·in	1.300	7675140	8559-04

# 8560 A - 8565 AL TORQUE WRENCH DREMOMETER

8-40 N·m / 70-350 lbf·in

**Use:**

- > Controlled screw tightening in the range 8-40 N·m / 70-350 lbf·in
- > For use in almost all industrial manufacturing areas

**Features:**

- > Classified to DIN EN ISO 6789:2003 Type II Class A, with a factory certificate. Working accuracy: +/- 3 % tolerance of scale set torque. The specification of the standard (+/- 4 %) is exceeded.
- > 3/8" square drive with ball locking device DIN 3120 - A 10, ISO 1174
- > Automatic short-path actuation with tactile impulse and audible signal
- > Dual scale with a scale graduation of 5 N·m and 50 lbf·in

**Technical advantage/Function:**

- > Lightweight and robust (as housing is made of an aluminium alloy), very workshop-friendly
- > No inaccuracies whether used with both hands or held away from the handle (as for standard torque wrenches). Both the square drive and fulcrum are on an axis which ensures a high degree of user safety; can be extended to reduce the user's working load.
- > Extremely low wear attributable to reduced forces in a unique lever mechanism
- > Forged lever chain from our own quality forge
- > Maximum precision even when subjected to extreme continuous use
- > Long life cycles and tool lives
- > Easy operation - fast and safe torque tightening
- > Easy adjustment thanks to attractive adjusting button secured against loss at the end of the handle
- > Single- and double-square drive for controlled bi-directional tightening



8560-03

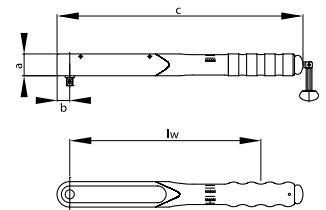

Type	□"	■	Contents	N·m	lbf·in	lw	a	b	c			Code	No.
	3/8	10	in plastic box	8-40	70-350	262	30	17.5	338	5 N·m / 50 lbf·in	1.0	7682000	8560-01
	3/8	10	in a sheet-metal case	8-40	70-350	262	30	17.5	338	5 N·m / 50 lbf·in	2.2	7682270	8560-02
	3/8	10	Set mm ○ 8 10 11 13 14 15 17 19 ● 4 5 6 8 ⊗ 754-01  125 + 250 mm	8-40	70-350	262	30	17.5	338	5 N·m / 50 lbf·in	3.1	7682430	8560-03
	3/8	10	Set INCH ○ 3/8 7/16 1/2 9/16 19/32 5/8 11/16 ● 1/4 5/16 3/8 ⊗ 754-01  125 + 250 mm	8-40	70-350	262	30	17.5	338	5 N·m / 50 lbf·in	3.0	7683160	8560-04
	3/8	10	in plastic box	8-40	70-350	262	30	17.5	338	5 N·m / 50 lbf·in	1.0	7682190	8565-01
	3/8	10	in a sheet-metal case	8-40	70-350	262	30	17.5	338	5 N·m / 50 lbf·in	2.2	7682350	8565-02
	3/8	10	Set mm ○ 8 10 11 13 14 15 17 19 ● 4 5 6 8 ⊗ 754-01  125 + 250 mm	8-40	70-350	262	30	17.5	338	5 N·m / 50 lbf·in	3.1	7682940	8565-03
	3/8	10	Set INCH ○ 3/8 7/16 1/2 9/16 19/32 5/8 11/16 ● 1/4 5/16 3/8 ⊗ 754-01  125 + 250 mm	8-40	70-350	262	30	17.5	338	5 N·m / 50 lbf·in	3.0	7683240	8565-04



# 8561 B - 8566 BL

## TORQUE WRENCH DREMOMETER

25-120 N·m / 18-90 lbf·ft

**Use:**

- > Controlled screw tightening in the range 25-120 N-m / 18-90 lbf-ft
- > For use in almost all industrial manufacturing areas

**Features:**

- > Classified to DIN EN ISO 6789:2003 Type II Class A, with a factory certificate. Working accuracy: +/- 3 % tolerance of scale set torque. The specification of the standard (+/- 4 %) is exceeded.
- > 1/2" square drive with ball locking device DIN 3120 - A 12.5, ISO 1174
- > Automatic short-path actuation with tactile impulse and audible signal
- > Dual scale with a scale graduation of 5 N-m and 5 lbf-ft
- > **With push-button release**

**Technical advantage/Function:**

- > Lightweight and robust (as housing is made of an aluminium alloy), very workshop-friendly
- > No inaccuracies whether used with both hands or held away from the handle (as for standard torque wrenches). Both the square drive and fulcrum are on an axis which ensures a high degree of user safety; can be extended to reduce the user's working load.
- > Extremely low wear attributable to reduced forces in a unique lever mechanism
- > Forged lever chain from our own quality forge
- > Maximum precision even when subjected to extreme continuous use
- > Long life cycles and tool lives
- > Easy operation - fast and safe torque tightening
- > Easy adjustment thanks to attractive adjusting button secured against loss at the end of the handle
- > Single- and double-square drive for controlled bi-directional tightening

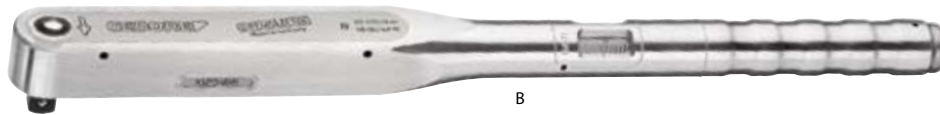

8561-03



BR

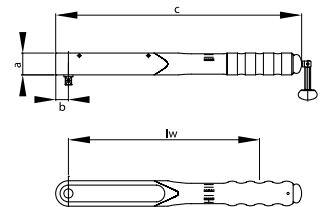

Type	□"	■	Contents	N-m	lbf-ft	lw	a	b	c	Tube	📏	⚖️	Code	No.
BR	1/2	12.5	in plastic box with ALU extension tube	25-120	18-90	373	30	17.5	462	8577-350	5 N-m / 5 lbf-ft	2.2	2926989	8561-001
B	1/2	12.5	in plastic box	25-120	18-90	373	30	17.5	462	-	5 N-m / 5 lbf-ft	1.5	7683320	8561-01
B	1/2	12.5	in a sheet-metal case	25-120	18-90	373	30	17.5	462	-	5 N-m / 5 lbf-ft	2.8	7683830	8561-02
B	1/2	12.5	Set mm ○ 11 13 14 17 19 22 24 ● 6 8 10 12 🔧 754-02 ← 76 + 125 + 250 mm	25-120	18-90	373	30	17.5	462	-	5 N-m / 5 lbf-ft	4.7	7684480	8561-03
B	1/2	12.5	Set INCH ○ 7/16 1/2 9/16 19/32 5/8 11/16 3/4 25/32 13/16 7/8 15/16 1" ● 5/16 3/8 1/2" 🔧 754-02 ← 76 + 125 + 250 mm	25-120	18-90	373	30	17.5	462	-	5 N-m / 5 lbf-ft	5.3	7684990	8561-04
BL	1/2	12.5	in plastic box	25-120	18-90	373	30	17.5	462	-	5 N-m / 5 lbf-ft	1.5	7683400	8566-01
BL	1/2	12.5	in a sheet-metal case	25-120	18-90	373	30	17.5	462	-	5 N-m / 5 lbf-ft	2.8	7684130	8566-02
BL	1/2	12.5	Set mm ○ 11 13 14 17 19 22 24 ● 6 8 10 12 🔧 754-02 ← 76 + 125 + 250 mm	25-120	18-90	373	30	17.5	462	-	5 N-m / 5 lbf-ft	4.7	7684640	8566-03
BL	1/2	12.5	Set INCH ○ 7/16 1/2 9/16 19/32 5/8 11/16 3/4 25/32 13/16 7/8 15/16 1" ● 5/16 3/8 1/2" 🔧 754-02 ← 76 + 125 + 250 mm	25-120	18-90	373	30	17.5	462	-	5 N-m / 5 lbf-ft	5.3	7685100	8566-04

# 8573 BC - 8578 BCL TORQUE WRENCH DREMOMETER

40-200 N·m / 30-150 lbf·ft

**Use:**

- > Controlled screw tightening in the range 40-200 N·m / 30-150 lbf·ft
- > For use in almost all industrial manufacturing areas

**Features:**

- > Classified to DIN EN ISO 6789:2003 Type II Class A, with a factory certificate. Working accuracy: +/- 3 % tolerance of scale set torque. The specification of the standard (+/- 4 %) is exceeded.
- > 1/2" square drive with ball locking device DIN 3120 - A 12.5, ISO 1174
- > Automatic short-path actuation with tactile impulse and audible signal
- > Dual scale with a scale graduation of 5 N·m and 5 lbf·ft
- > **With push-button release**

**Technical advantage/Function:**

- > Lightweight and robust (as housing is made of an aluminium alloy), very workshop-friendly
- > No inaccuracies whether used with both hands or held away from the handle (as for standard torque wrenches). Both the square drive and fulcrum are on an axis which ensures a high degree of user safety; can be extended to reduce the user's working load.
- > Extremely low wear attributable to reduced forces in a unique lever mechanism
- > Forged lever chain from our own quality forge
- > Maximum precision even when subjected to extreme continuous use
- > Long life cycles and tool lives
- > Easy operation - fast and safe torque tightening
- > Easy adjustment thanks to attractive adjusting button secured against loss at the end of the handle
- > Single- and double-square drive for controlled bi-directional tightening



BC



8573-03

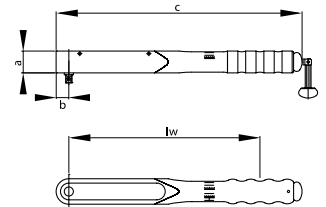

Type	□"	■"	Contents	N·m	lbf·ft	lw	a	b	c			Code	No.
BC	1/2	12.5	in plastic box	40-200	30-150	463	30	17.5	551	5 N·m / 5 lbf·ft	1.4	7685530	8573-00
BC	1/2	12.5	in a sheet-metal case	40-200	30-150	463	30	17.5	551	5 N·m / 5 lbf·ft	3.5	7683590	8573-02
BC	1/2	12.5	Set mm ○ 11 13 14 17 19 21 22 24 27 ● 6 8 10 12 ⊗ 754-02  125 + 250 mm	40-200	30-150	463	30	17.5	551	5 N·m / 5 lbf·ft	5.1	7683910	8573-03
BC	1/2	12.5	Set INCH ○ 1/2 9/16 5/8 11/16 3/4 13/16 7/8" ● 5/16 3/8 1/2 9/16" ⊗ 754-02  125 + 250 mm	40-200	30-150	463	30	17.5	551	5 N·m / 5 lbf·ft	4.9	7684720	8573-04
BCL	1/2	12.5	in plastic box	40-200	30-150	463	30	17.5	551	5 N·m / 5 lbf·ft	1.3	7683670	8578-00
BCL	1/2	12.5	in a sheet-metal case	40-200	30-150	463	30	17.5	551	5 N·m / 5 lbf·ft	3.5	7683750	8578-02
BCL	1/2	12.5	Set mm ○ 11 13 14 17 19 21 22 24 27 ● 6 8 10 12 ⊗ 754-02  125 + 250 mm	40-200	30-150	463	30	17.5	551	5 N·m / 5 lbf·ft	5.1	7684050	8578-03
BCL	1/2	12.5	Set INCH ○ 1/2 9/16 5/8 11/16 3/4 13/16 7/8" ● 5/16 3/8 1/2 9/16" ⊗ 754-02  125 + 250 mm	40-200	30-150	463	30	17.5	551	5 N·m / 5 lbf·ft	4.9	7684210	8578-04



# 8562 C - 8567 CL

## TORQUE WRENCH DREMOMETER

60-300 N·m / 45-220 lbf·ft

**Use:**

- > Controlled screw tightening in the range 60-300 N·m / 45-220 lbf·ft
- > For use in almost all industrial manufacturing areas

**Features:**

- > Classified to DIN EN ISO 6789:2003 Type II Class A, with a factory certificate. Working accuracy: +/- 3 % tolerance of scale set torque. The specification of the standard (+/- 4 %) is exceeded.
- > 1/2" square drive with ball locking device DIN 3120 - A 12.5, ISO 1174
- > Automatic short-path actuation with tactile impulse and audible signal
- > Dual scale with a scale graduation of 5 N·m and 5 lbf·ft
- > **With push-button release**

**Technical advantage/Function:**

- > Lightweight and robust (as housing is made of an aluminium alloy), very workshop-friendly
- > No inaccuracies whether used with both hands or held away from the handle (as for standard torque wrenches). Both the square drive and fulcrum are on an axis which ensures a high degree of user safety; can be extended to reduce the user's working load.
- > Extremely low wear attributable to reduced forces in a unique lever mechanism
- > Forged lever chain from our own quality forge
- > Maximum precision even when subjected to extreme continuous use
- > Long life cycles and tool lives
- > Easy operation - fast and safe torque tightening
- > Easy adjustment thanks to attractive adjusting button secured against loss at the end of the handle
- > Single- and double-square drive for controlled bi-directional tightening



8562-30



CR

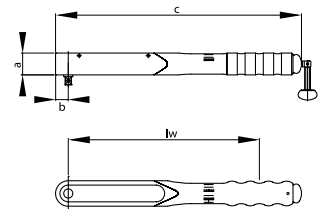

Type	□	■	Contents	N·m	lbf·ft	lw	a	b	c	Tube	📏	⚖️	Code	No.
CR	1/2	12.5	🔧 in plastic box with ALU extension tube	60-300	45-220	529	30	17.5	617	8577-700	5 N·m / 5 lbf·ft	2.7	2926997	8562-001
C	1/2	12.5	🔧 in plastic box	60-300	45-220	529	30	17.5	617	-	5 N·m / 5 lbf·ft	2.0	7685450	8562-10
C	1/2	12.5	🔧 in a sheet-metal case	60-300	45-220	529	30	17.5	617	-	5 N·m / 5 lbf·ft	3.6	7686340	8562-20
C	1/2	12.5	🔧 Set mm ⊙ 17 19 22 24 27 30 32 ● 8 10 12 14 🔧 754-02 🔧 76 + 125 + 250 mm	60-300	45-220	529	30	17.5	617	-	5 N·m / 5 lbf·ft	6.0	7687070	8562-30
C	1/2	12.5	🔧 Set INCH ⊙ 3/4 25/32 13/16 7/8 15/16 1" 1.1/16 1.1/8 1.1/4" ● 3/8 1/2 9/16 5/8" 🔧 754-02 🔧 76 + 125 + 250 mm	60-300	45-220	529	30	17.5	617	-	5 N·m / 5 lbf·ft	6.2	7687820	8562-40
CL	1/2	12.5	🔧 in plastic box	60-300	45-220	529	30	17.5	617	-	5 N·m / 5 lbf·ft	2.0	7685960	8567-10
CL	1/2	12.5	🔧 in a sheet-metal case	60-300	45-220	529	30	17.5	617	-	5 N·m / 5 lbf·ft	3.6	7686690	8567-20
CL	1/2	12.5	🔧 Set mm ⊙ 17 19 22 24 27 30 32 ● 8 10 12 14 🔧 754-02 🔧 76 + 125 + 250 mm	60-300	45-220	529	30	17.5	617	-	5 N·m / 5 lbf·ft	6.0	7687310	8567-30
CL	1/2	12.5	🔧 Set INCH ⊙ 3/4 25/32 13/16 7/8 15/16 1" 1.1/16 1.1/8 1.1/4" ● 3/8 1/2 9/16 5/8" 🔧 754-02 🔧 76 + 125 + 250 mm	60-300	45-220	529	30	17.5	617	-	5 N·m / 5 lbf·ft	6.2	7688120	8567-40



# 8570 CD - 8575 CDL TORQUE WRENCH DREMOMETER

80-360 N·m / 60-260 lbf·ft

**Use:**

- > Controlled screw tightening in the range 80-360 N·m / 60-260 lbf·ft
- > For use in almost all industrial manufacturing areas

**Features:**

- > Classified to DIN EN ISO 6789:2003 Type II Class A, with a factory certificate. Working accuracy: +/- 3 % tolerance of scale set torque. The specification of the standard (+/- 4 %) is exceeded.
- > 3/4" square drive with pin-locking mechanism as per DIN 3120 - B 20, ISO 1174
- > Automatic short-path actuation with tactile impulse and audible signal
- > Dual scale with a scale graduation of 5 N·m and 5 lbf·ft

**Technical advantage/Function:**

- > Lightweight and robust (as housing is made of an aluminium alloy), very workshop-friendly
- > No inaccuracies whether used with both hands or held away from the handle (as for standard torque wrenches). Both the square drive and fulcrum are on an axis which ensures a high degree of user safety; can be extended to reduce the user's working load.
- > Extremely low wear attributable to reduced forces in a unique lever mechanism
- > Forged lever chain from our own quality forge
- > Maximum precision even when subjected to extreme continuous use
- > Long life cycles and tool lives
- > Easy operation - fast and safe torque tightening
- > Easy adjustment thanks to attractive adjusting button secured against loss at the end of the handle
- > Single- and double-square drive for controlled bi-directional tightening



8570-30



CDR

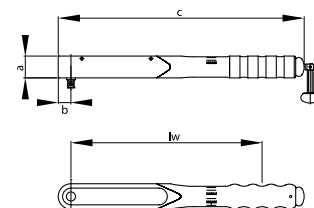

Type	■"	■	Contents	N·m	lbf·ft	lw	a	b	c	Tube	📏	🏋️	Code	No.
CDR	3/4	20	in plastic box with ALU extension tube	80-360	60-260	624	30	22.5	717	8577-700	5 N·m / 5 lbf·ft	3.1	2927004	8570-001
CD	3/4	20	in plastic box	80-360	60-260	624	30	22.5	717	-	5 N·m / 5 lbf·ft	2.4	7688470	8570-10
CD	3/4	20	in a sheet-metal case	80-360	60-260	624	30	22.5	717	-	5 N·m / 5 lbf·ft	6.2	7689280	8570-20
CD	3/4	20	Set mm ○ 19 22 24 27 30 32 🔧 754-04 → 200 + 400 mm	80-360	60-260	624	30	22.5	717	-	5 N·m / 5 lbf·ft	11.0	7689950	8570-30
CD	3/4	20	Set INCH ○ 7/8 15/16 1" 1.1/8 1.1/4 1.3/8 1.1/2 1.5/8" 🔧 754-04 → 200 + 400 mm	80-360	60-260	624	30	22.5	717	-	5 N·m / 5 lbf·ft	11.3	7690530	8570-40
CDL	3/4	20	in plastic box	80-360	60-260	624	30	22.5	717	-	5 N·m / 5 lbf·ft	2.4	7688710	8575-10
CDL	3/4	20	in a sheet-metal case	80-360	60-260	624	30	22.5	717	-	5 N·m / 5 lbf·ft	6.2	7689520	8575-20
CDL	3/4	20	Set mm ○ 19 22 24 27 30 32 🔧 754-04 → 200 + 400 mm	80-360	60-260	624	30	22.5	717	-	5 N·m / 5 lbf·ft	11.0	7690290	8575-30
CDL	3/4	20	Set INCH ○ 7/8 15/16 1" 1.1/8 1.1/4 1.3/8 1.1/2 1.5/8" 🔧 754-04 → 200 + 400 mm	80-360	60-260	624	30	22.5	717	-	5 N·m / 5 lbf·ft	11.3	7691180	8575-40



# 8574 DS - 8579 DSL TORQUE WRENCH DREMOMETER

110-550 N·m / 80-400 lbf·ft

**Use:**

- > Controlled screw tightening in the range 110-550 N·m / 80-400 lbf·ft
- > For use in almost all industrial manufacturing areas

**Features:**

- > Classified to DIN EN ISO 6789:2003 Type II Class A, with a factory certificate. Working accuracy: +/- 3 % tolerance of scale set torque. The specification of the standard (+/- 4 %) is exceeded.
- > 3/4" square drive with pin-locking mechanism DIN 3120 - B 20, ISO 1174
- > Automatic short-path actuation with tactile impulse and audible signal
- > Dual scale with a scale graduation of 10 N·m and 10 lbf·ft

**Technical advantage/Function:**

- > Lightweight and robust (as housing is made of an aluminium alloy), very workshop-friendly
- > No inaccuracies whether used with both hands or held away from the handle (as for standard torque wrenches). Both the square drive and fulcrum are on an axis which ensures a high degree of user safety; can be extended to reduce the user's working load.
- > Extremely low wear attributable to reduced forces in a unique lever mechanism
- > Forged lever chain from our own quality forge
- > Maximum precision even when subjected to extreme continuous use
- > Long life cycles and tool lives
- > Easy operation - fast and safe torque tightening
- > Easy adjustment thanks to attractive adjusting button secured against loss at the end of the handle
- > Single- and double-square drive for controlled bi-directional tightening

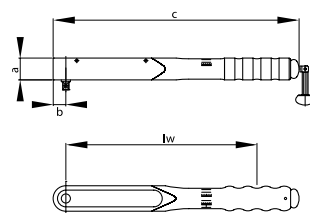

Type	□"	■	Contents	N·m	lbf·ft	lw	a	b	c			Code	No.
DS	3/4	20	in plastic box	110-550	80-400	719	35	22.5	812	10 N·m / 10 lbf·ft	2.9	1427156	8574-10
DS	3/4	20	in a sheet-metal case	110-550	80-400	719	35	22.5	812	10 N·m / 10 lbf·ft	6.7	1436112	8574-20
DSL	3/4	20	in plastic box	110-550	80-400	719	35	22.5	812	10 N·m / 10 lbf·ft	2.9	1427121	8579-10
DSL	3/4	20	in a sheet-metal case	110-550	80-400	719	35	22.5	812	10 N·m / 10 lbf·ft	6.7	1436120	8579-20

920 / 922 >565

754 >281

DVV-40ZRS >335

# 8563 D - 8568 DL

## TORQUE WRENCH DREMOMETER

155-760 N·m / 115-560 lbf·ft

### Use:

- > Controlled screw tightening in the range 155-760 N·m / 115-560 lbf·ft
- > For use in almost all industrial manufacturing areas

### Features:

- > Classified to DIN EN ISO 6789:2003 Type II Class A, with a factory certificate. Working accuracy: +/- 3 % tolerance of scale set torque. The specification of the standard (+/- 4 %) is exceeded.
- > 3/4" square drive with pin-locking mechanism DIN 3120 - B 20, ISO 1174
- > Automatic short-path actuation with tactile impulse and audible signal
- > Dual scale with a scale graduation of 10 N·m and 10 lbf·ft

### Technical advantage/Function:

- > Lightweight and robust (as housing is made of an aluminium alloy), very workshop-friendly
- > No inaccuracies whether used with both hands or held away from the handle (as for standard torque wrenches). Both the square drive and fulcrum are on an axis which ensures a high degree of user safety; can be extended to reduce the user's working load.
- > Extremely low wear attributable to reduced forces in a unique lever mechanism
- > Forged lever chain from our own quality forge
- > Maximum precision even when subjected to extreme continuous use
- > Long life cycles and tool lives
- > Easy operation - fast and safe torque tightening
- > Easy adjustment thanks to attractive adjusting button secured against loss at the end of the handle
- > Single- and double-square drive for controlled bi-directional tightening



DL



D



8563-30

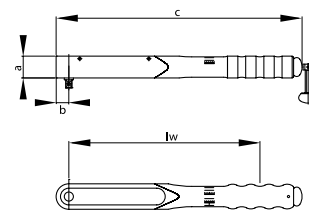

Type	□"	■	Contents	N·m	lbf·ft	lw	a	b	c			Code	No.
D	3/4	20	in plastic box	155-760	115-560	719	35	22.5	812	10 N·m / 10 lbf·ft	3.2	7691500	8563-10
D	3/4	20	in a sheet-metal case	155-760	115-560	719	35	22.5	812	10 N·m / 10 lbf·ft	7.7	7692070	8563-20
D	3/4	20	Set mm ○ 22 24 27 30 32 36 41 46 ⊗ 754-04  200 + 400 mm	155-760	115-560	719	35	22.5	812	10 N·m / 10 lbf·ft	13.6	7692660	8563-30
D	3/4	20	Set INCH ○ 1" 1.1/8 1.1/4 1.5/16 1.3/8 1.7/16 1.1/2 1.5/8 1.3/4 1.13/16 1.7/8 2" ⊗ 754-04  200 + 400 mm	155-760	115-560	719	35	22.5	812	10 N·m / 10 lbf·ft	13.3	7693200	8563-40
DL	3/4	20	in plastic box	155-760	115-560	719	35	22.5	812	10 N·m / 10 lbf·ft	3.2	7691850	8568-10
DL	3/4	20	in a sheet-metal case	155-760	115-560	719	35	22.5	812	10 N·m / 10 lbf·ft	7.7	7692310	8568-20
DL	3/4	20	Set mm ○ 22 24 27 30 32 36 41 46 ⊗ 754-04  200 + 400 mm	155-760	115-560	719	35	22.5	812	10 N·m / 10 lbf·ft	13.6	7692900	8568-30
DL	3/4	20	Set INCH ○ 1" 1.1/8 1.1/4 1.5/16 1.3/8 1.7/16 1.1/2 1.5/8 1.3/4 1.13/16 1.7/8 2" ⊗ 754-04  200 + 400 mm	155-760	115-560	719	35	22.5	812	10 N·m / 10 lbf·ft	13.3	7693550	8568-40

# 8563 DR - 8568 DRL TORQUE WRENCH DREMOMETER

155-760 N·m / 115-560 lbf·ft

**Use:**

- > Controlled screw tightening in the range 155-760 N·m / 115-560 lbf·ft
- > For use in almost all industrial manufacturing areas

**Features:**

- > Classified to DIN EN ISO 6789:2003 Type II Class A, with a factory certificate. Working accuracy: +/- 3 % tolerance of scale set torque. The specification of the standard (+/- 4 %) is exceeded.
- > 3/4" square drive with pin-locking mechanism DIN 3120 - B 20, ISO 1174
- > Automatic short-path actuation with tactile impulse and audible signal
- > Dual scale with a scale graduation of 10 N·m and 10 lbf·ft

**Technical advantage/Function:**

- > Lightweight and robust (as housing is made of an aluminium alloy), very workshop-friendly
- > No inaccuracies whether used with both hands or held away from the handle (as for standard torque wrenches). Both the square drive and fulcrum are on an axis which ensures a high degree of user safety; can be extended to reduce the user's working load.
- > Extremely low wear attributable to reduced forces in a unique lever mechanism
- > Forged lever chain from our own quality forge
- > Maximum precision even when subjected to extreme continuous use
- > Long life cycles and tool lives
- > Easy operation - fast and safe torque tightening
- > Easy adjustment thanks to attractive adjusting button secured against loss at the end of the handle
- > Single- and double-square drive for controlled bi-directional tightening

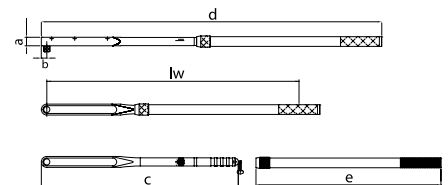

Type	□	■	Contents	N·m	lbf·ft	lw	a	b	c	d	e	Tube	Scale	Weight	Code	No.
DR	3/4	20	in plastic box with extension tube	155-760	115-560	1,290.5	35	22.5	812	1403	762	8571-80	10 N·m / 10 lbf·ft	5.0	7670180	8563-01
DR	3/4	20	in a sheet-metal case with extension tube	155-760	115-560	1,290.5	35	22.5	812	1403	762	8571-80	10 N·m / 10 lbf·ft	8.8	7670260	8563-02
DR	3/4	20	Set mm ○ 22 24 27 30 32 36 41 46 ⊗ 754-04 ← 200 + 400 mm	155-760	115-560	1,290.5	35	22.5	812	1403	762	8571-80	10 N·m / 10 lbf·ft	14.4	7670340	8563-03
DR	3/4	20	Set INCH ○ 1" 1.1/8 1.1/4 1.5/16 1.3/8 1.7/16 1.1/2 1.5/8 1.3/4 1.13/16 1.7/8 2" ⊗ 754-04 ← 200 + 400 mm	155-760	115-560	1,290.5	35	22.5	812	1403	762	8571-80	10 N·m / 10 lbf·ft	16.7	7670420	8563-04
DRL	3/4	20	in plastic box with extension tube	155-760	115-560	1,290.5	35	22.5	812	1403	762	8571-80	10 N·m / 10 lbf·ft	5.0	7670500	8568-01
DRL	3/4	20	in a sheet-metal case with extension tube	155-760	115-560	1,290.5	35	22.5	812	1403	762	8571-80	10 N·m / 10 lbf·ft	8.8	7670690	8568-02
DRL	3/4	20	Set mm ○ 22 24 27 30 32 36 41 46 ⊗ 754-04 ← 200 + 400 mm	155-760	115-560	1,290.5	35	22.5	812	1403	762	8571-80	10 N·m / 10 lbf·ft	14.4	7670770	8568-03
DRL	3/4	20	Set INCH ○ 1" 1.1/8 1.1/4 1.5/16 1.3/8 1.7/16 1.1/2 1.5/8 1.3/4 1.13/16 1.7/8 2" ⊗ 754-04 ← 200 + 400 mm	155-760	115-560	1,290.5	35	22.5	812	1403	762	8571-80	10 N·m / 10 lbf·ft	16.7	7670850	8568-04
DR-LKW	3/4	20	Set mm ○ 27 30 32 ⊗ 754-04 ← 400 mm	155-760	115-560	1,290.5	35	22.5	812	1403	762	8571-80	10 N·m / 10 lbf·ft	12.3	7670930	8568-35

# 8571 DX - 8576 DXL TORQUE WRENCH DREMOMETER

520-1000 N·m / 380-730 lbf·ft

**Use:**

- > Controlled screw tightening in the range 520-1000 N·m / 380-730 lbf·ft
- > For use in almost all industrial manufacturing areas

**Features:**

- > Classified to DIN EN ISO 6789:2003 Type II Class A, with a factory certificate. Working accuracy: +/- 3 % tolerance of scale set torque. The specification of the standard (+/- 4 %) is exceeded.
- > 3/4" square drive with pin-locking mechanism DIN 3120 - B 20, ISO 1174
- > Automatic short-path actuation with tactile impulse and audible signal
- > Dual scale with a scale graduation of 10 N·m and 10 lbf·ft

**Technical advantage/Function:**

- > Lightweight and robust (as housing is made of an aluminium alloy), very workshop-friendly
- > No inaccuracies whether used with both hands or held away from the handle (as for standard torque wrenches). Both the square drive and fulcrum are on an axis which ensures a high degree of user safety; can be extended to reduce the user's working load.
- > Extremely low wear attributable to reduced forces in a unique lever mechanism
- > Forged lever chain from our own quality forge
- > Maximum precision even when subjected to extreme continuous use
- > Long life cycles and tool lives
- > Easy operation - fast and safe torque tightening
- > Easy adjustment thanks to attractive adjusting button secured against loss at the end of the handle
- > Single- and double-square drive for controlled bi-directional tightening

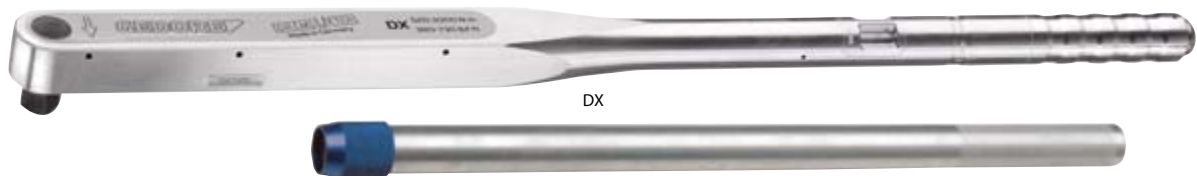

8571-03

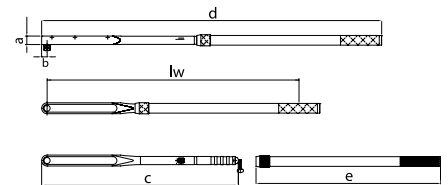

Type	□"	■	Contents	N·m	lbf·ft	lw	a	b	c	d	e	Tube			Code	No.
DX	3/4	20	in plastic box with ALU extension tube	520-1000	380-730	1,290.5	35	22.5	812	1403	762	8571-80	10 N·m / 10 lbf·ft	5.6	7694010	8571-01
DX	3/4	20	in a sheet-metal case with ALU extension tube	520-1000	380-730	1,290.5	35	22.5	812	1403	762	8571-80	10 N·m / 10 lbf·ft	10.0	7694520	8571-02
DX	3/4	20	Set mm ○ 30 32 36 41 46 50 ⊗ 754-04  200 + 400 mm	520-1000	380-730	1,290.5	35	22.5	812	1403	762	8571-80	10 N·m / 10 lbf·ft	16.8	7694870	8571-03
DX	3/4	20	Set INCH ○ 1.1/8 1.1/4 1.3/8 1.1/2 1.3/4 1.7/8" ⊗ 754-04  200 + 400 mm	520-1000	380-730	1,290.5	35	22.5	812	1403	762	8571-80	10 N·m / 10 lbf·ft	16.0	7695170	8571-04
DXL	3/4	20	in plastic box with ALU extension tube	520-1000	380-730	1,290.5	35	22.5	812	1403	762	8571-80	10 N·m / 10 lbf·ft	5.6	7694360	8576-01
DXL	3/4	20	in a sheet-metal case with ALU extension tube	520-1000	380-730	1,290.5	35	22.5	812	1403	762	8571-80	10 N·m / 10 lbf·ft	10.0	7694600	8576-02
DXL	3/4	20	Set mm ○ 30 32 36 41 46 50 ⊗ 754-04  200 + 400 mm	520-1000	380-730	1,290.5	35	22.5	812	1403	762	8571-80	10 N·m / 10 lbf·ft	16.8	7694950	8576-03
DXL	3/4	20	Set INCH ○ 1.1/8 1.1/4 1.3/8 1.1/2 1.3/4 1.7/8" ⊗ 754-04  200 + 400 mm	520-1000	380-730	1,290.5	35	22.5	812	1403	762	8571-80	10 N·m / 10 lbf·ft	16.0	7695330	8576-04



# 8581 EK - 8586 EKL TORQUE WRENCH DREMOMETER

600-1500 N·m

**Use:**

- > Controlled screw tightening in the range 600-1500 N·m
- > For use in almost all industrial manufacturing areas

**Features:**

- > Classified to DIN EN ISO 6789:2003 Type II Class A, with a factory certificate. Working accuracy: +/- 3 % tolerance of scale set torque. The specification of the standard (+/- 4 %) is exceeded.
- > 1" square drive with pin-locking mechanism DIN 3120 - B25, ISO 1174
- > Automatic short-path actuation with tactile impulse and audible signal
- > Single scale with a scale graduation of 25 N·m

**Technical advantage/Function:**

- > Lightweight and robust (as housing is made of an aluminium alloy), very workshop-friendly
- > No inaccuracies whether used with both hands or held away from the handle (as for standard torque wrenches). Both the square drive and fulcrum are on an axis which ensures a high degree of user safety; can be extended to reduce the user's working load.
- > Extremely low wear attributable to reduced forces in a unique lever mechanism
- > Forged lever chain from our own quality forge
- > Maximum precision even when subjected to extreme continuous use
- > Long life cycles and tool lives
- > Easy operation - fast and safe torque tightening
- > Easy adjustment thanks to attractive adjusting button secured against loss at the end of the handle
- > Single- and double-square drive for controlled bi-directional tightening



8581-02

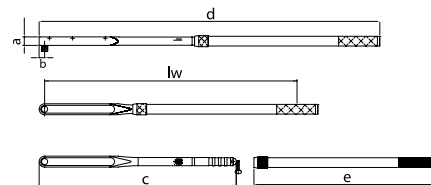

Type	■"	■	Contents	N·m	lw	a	b	c	d	e	Tube			Code	No.
EK	1	25	with 1 extension tube	600-1500	1473	40	30	932	1608	925	8564-92	25 N·m	10.8	2311267	8581-01
EK	1	25	in sheet-metal case with 1 extension tube	600-1500	1473	40	30	932	1608	925	8564-92	25 N·m	24.3	2311275	8581-02
EK	1	25	Set mm ○ 36 41 46 50 55 60 65 70 ⊗ 754-06  200 + 400 mm	600-1500	1473	40	30	932	1608	925	8564-92	25 N·m	42.4	2311283	8581-03
EKL	1	25	with 1 extension tube	600-1500	1473	40	30	932	1608	925	8564-92	25 N·m	10.8	2311291	8586-01
EKL	1	25	in sheet-metal case with 1 extension tube	600-1500	1473	40	30	932	1608	925	8564-92	25 N·m	24.3	2311305	8586-02
EKL	1	25	Set mm ○ 36 41 46 50 55 60 65 70 ⊗ 754-06  200 + 400 mm	600-1500	1473	40	30	932	1608	925	8564-92	25 N·m	42.4	2311313	8586-03



# 8564 E - 8569 EL TORQUE WRENCH DREMOMETER

750-2000 N·m

**Use:**

- > Controlled screw tightening in the range 750-2000 N·m
- > For use in almost all industrial manufacturing areas

**Features:**

- > Classified to DIN EN ISO 6789:2003 Type II Class A, with a factory certificate. Working accuracy: +/- 3 % tolerance of scale set torque. The specification of the standard (+/- 4 %) is exceeded.
- > 1" square drive with pin-locking mechanism DIN 3120 - B25, ISO 1174
- > Automatic short-path actuation with tactile impulse and audible signal
- > Single scale with a scale graduation of 50 N·m

**Technical advantage/Function:**

- > Lightweight and robust (as housing is made of an aluminium alloy), very workshop-friendly
- > No inaccuracies whether used with both hands or held away from the handle (as for standard torque wrenches). Both the square drive and fulcrum are on an axis which ensures a high degree of user safety; can be extended to reduce the user's working load.
- > Extremely low wear attributable to reduced forces in a unique lever mechanism
- > Forged lever chain from our own quality forge
- > Maximum precision even when subjected to extreme continuous use
- > Long life cycles and tool lives
- > Easy operation - fast and safe torque tightening
- > Easy adjustment thanks to attractive adjusting button secured against loss at the end of the handle
- > Single- and double-square drive for controlled bi-directional tightening



8564-02

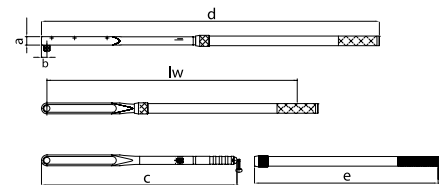

Type	█"	█	Contents	N·m	lw	a	b	c	d	e	f	Tube			Code	No.
E	1	25	 with 2 extension tubes	750-2000	2213	40	30.0	932	2353	925	745	8564-92 / 8572-74	50 N·m	12.0	7695250	8564-01
E	1	25	 in sheet-metal case with 2 extension tubes	750-2000	2213	40	30.0	932	2353	925	745	8564-92 / 8572-74	50 N·m	21.2	7695680	8564-02
E	1	25	 Set mm ⊙ 36 41 46 50 55 60 65 70 ⊙ 754-06  200 + 400 mm	750-2000	2213	40	30.0	932	2353	925	745	8564-92 / 8572-74	50 N·m	42.4	7696060	8564-03
EL	1	25	 with 2 extension tubes	750-2000	2213	40	30.0	932	2353	925	745	8564-92 / 8572-74	50 N·m	12.0	7695410	8569-01
EL	1	25	 in sheet-metal case with 2 extension tubes	750-2000	2213	40	30.0	932	2353	925	745	8564-92 / 8572-74	50 N·m	21.4	7695840	8569-02
EL	1	25	 Set mm ⊙ 36 41 46 50 55 60 65 70 ⊙ 754-06  200 + 400 mm	750-2000	2213	40	30.0	932	2353	925	745	8564-92 / 8572-74	50 N·m	42.4	7696140	8569-03

# 8572 F TORQUE WRENCH DREMOMETER

1500-3000 N·m

**Use:**

- > Controlled screw tightening in the range 1500-3000 N·m
- > For use in almost all industrial manufacturing areas

**Features:**

- > Classified to DIN EN ISO 6789:2003 Type II Class A, with a factory certificate. Working accuracy: +/- 3 % tolerance of scale set torque. The specification of the standard (+/- 4 %) is exceeded.
- > 1.1/2" square drive with pin-locking mechanism DIN 3121 - F 40, ISO 1174
- > Automatic short-path actuation with tactile impulse and audible signal
- > Single scale with scale graduation 50 N·m

**Technical advantage/Function:**

- > Lightweight and robust (as housing is made of an aluminium alloy), very workshop-friendly
- > No inaccuracies whether used with both hands or held away from the handle (as for standard torque wrenches). Both the square drive and fulcrum are on an axis which ensures a high degree of user safety; can be extended to reduce the user's working load.
- > Extremely low wear attributable to reduced forces in a unique lever mechanism
- > Forged lever chain from our own quality forge
- > Maximum precision even when subjected to extreme continuous use
- > Long life cycles and tool lives
- > Easy operation - fast and safe torque tightening
- > Easy adjustment thanks to attractive adjusting button secured against loss at the end of the handle
- > Single square drive for controlled clockwise tightening



F



8572-02

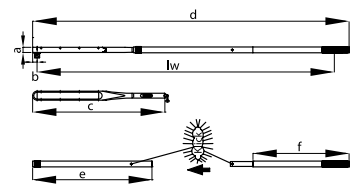

Type	□"	■	Contents	N·m	lw	a	b	c	d	e	f	Tube			Code	No.
F	1.1/2	40	with 2 extension tubes	1500-3000	2309	40	35.0	1037	2454	925	745	8564-92 / 8572-74	50 N·m	15.0	7717160	8572-01
F	1.1/2	40	in sheet-metal case with 2 extension tubes	1500-3000	2309	40	35.0	1037	2454	925	745	8564-92 / 8572-74	50 N·m	21.2	7717240	8572-02

## TECHNICAL INFORMATION



After being used, torque wrenches should where possible be turned back to the minimum scale value. This helps to preserve the springs and ensures a longer product life cycle with high precision.

On request, all torque wrenches can be factory pre-set **-at extra charge-** When ordering, please specify the N·m value



## Accessories DREMOMETER

# RATCHET HEADS DREMOMETER 754

> Ratchet head no. 754 can only be used in combination with the DREMOMETER. Please note the right direction of rotation by the ratchet head when ordering. There are separate models for clockwise or counter-clockwise rotation. Ratchet head nos. 754-11 to 754-16 (counter-clockwise) can only be used with the DREMOMETER with double square drive.



## 754 RATCHET HEAD DREMOMETER

**Use:**

> Enables controlled torque tightening in combination with a DREMOMETER torque wrench (Type MINI - E)

**Features:**

- > Fine-pitched, sturdy ratchet head
- > With 1/4", 3/8", 1/2", 3/4" or 1" output square drive
- > Clockwise models (no. 754-00 to -06)
- > Anti-clockwise models (no. 754-11 to -16)
- > Made of chrome-vanadium steel

**Scope of delivery:**

- > Ratchet head
- > Single packed in poly-bag

\* Max. continuous load of ratchet according to DIN EN ISO 6789:2003 and/or maximum load of cavity



□"	■"	H	∅ mm	∠°	Use	Execution	Continuous load*	kg	Code	No.
1/4	1/4	20	24	18,0	MINI, AM	clockwise	1/4" = 30 N-m	0.054	7680490	754-00
3/8	3/8	28	35	20,0	A	clockwise	3/8" = 135 N-m	0.150	7680570	754-01
1/2	1/2	36	46	7,5	B, BC, C	clockwise	1/2" = 340 N-m	0.350	7680650	754-02
3/4	3/4	56	65	10,0	CD, DS, D, DR, DX	clockwise	3/4" = 1000 N-m	1.000	7680730	754-04
1	1	62	73	10,0	E / EK	clockwise	1" = 2000 N-m	1.800	7680810	754-06
3/8	3/8	28	35	20,0	AL	counter-clockwise	3/8" = 135 N-m	0.150	7686770	754-11
1/2	1/2	36	46	7,5	BL, BCL, CL	counter-clockwise	1/2" = 340 N-m	0.350	7686850	754-12
3/4	3/4	56	65	10,0	CDL, DSL, DL, DRL, DXL	counter-clockwise	3/4" = 1000 N-m	1.000	7686930	754-14
1	1	62	73	10,0	EL / EKL	counter-clockwise	1" = 2000 N-m	1.800	7687150	754-16

## 8564 - 8572 EXTENSION TUBES FOR DREMOMETER E - F

**Use:**

- > Spare extension tube for torque wrench series DREMOMETER E - F
- > To enable high torque values by means of extending the lever arm

**Features:**

> Guarantees proof connection to the

**DREMOMETER**

- > Ideal for extending the lever arm
- > Made from high-grade, galvanised steel

**Scope of delivery:**

- > Extension tube
- > Single packed in poly-bag



## 8571 - 8577 EXTENSION TUBES ALU FOR DREMOMETER A - CD

**NEW**

**Use:**

- > Spare extension tube for torque wrench series DREMOMETER A - CD, DR, DX
- > To enable high torque values by means of extending the lever arm

**Features:**

> Guarantees proof connection to the DREMOMETER

- > Ideal for extending the lever arm
- > Made from high-grade aluminium with anodised locknut - extremely lightweight

**Scope of delivery:**

- > Extension tube
- > Single packed in poly-bag

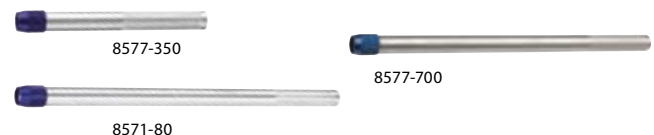

Use	Execution	∣ mm ∣	kg	Code	No.
<b>DREMOMETER E/F</b>	extension only	745	3.550	7622020	8572-74
<b>DREMOMETER E/EK/F</b>	with locknut	925	3.490	7621720	8564-92

Use	∣ mm ∣	kg	Code	No.
<b>DREMOMETER A-CD</b>	350	0.400	2880164	8577-350
<b>DREMOMETER A-CD</b>	700	0.850	2880032	8577-700
<b>DREMOMETER DR/DX</b>	762	0.750	1686313	8571-80

## DREMOMETER MINI / T-FS

# 753 TORQUE WRENCH DREMOMETER MINI

2.5-12 N·m / 22-106 lbf·in

**Use:**

- > Controlled screw tightening in the range 2.5 - 12 N·m / 22.5 - 106 lbf·in
- > For use in almost all industrial manufacturing areas

**Features:**

- > Classified to DIN EN ISO 6789:2003 Type II Class A, with a factory certificate. Working accuracy: +/- 3% tolerance of scale set torque. The specification of the standard (+/- 4%) is exceeded.
- > Torque wrench with 1/4" square drive with ball locking device DIN 3120 - A 6.3, similar to ISO 1174, for controlled clockwise tightening
- > Automatic short-path actuation with tactile impulse and audible signal
- > Lightweight plastic casing, made from high-grade, glass-fibre reinforced polyamide, with soft-grip handle
- > Dual scale with a scale graduation of 0.5 N·m and 5 lbf·in

- > Additional micrometre scale for setting interim values with N·m, graduations of 0.05 N·m
- > Window with a magnifying-glass effect
- > Locking button enables reliable locking of the torque setting

**Scope of delivery:**

- > Torque wrench type MINI
- > With certificate acc. to DIN EN ISO 6789:2003, traceable via in-house DAKKS laboratory to national standards

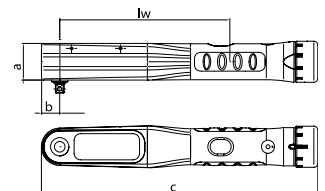

Type	1/4"	6.3	Contents	N·m	lbf·in	lw	a	b	c	Scale	Weight	Code	No.
MINI	1/4	6.3	in plastic box	2,5-12	22,5-106	130	28	14	211	0,5 N·m / 5 lbf·in + 0,05 N·m	0.320	1957694	753-11
MINI	1/4	6.3	in plastic cassette	2,5-12	22,5-106	130	28	14	211	0,5 N·m / 5 lbf·in + 0,05 N·m	0.628	1957708	753-12
MINI	1/4	6.3	Set mm ○ 4 5 5,5 6 7 8 9 10 ⊕ 1 2 3 ⊖ 4 5,5 6,5 ● 3 4 5 6 ● T20 T27 T30 ⊕ 754-00 ← 55 + 97 mm 2098	2,5-12	22,5-106	130	28	14	211	0,5 N·m / 5 lbf·in + 0,05 N·m	0.968	1957724	753-13
MINI	1/4	6.3	Set INCH ○ 3/16 7/32 1/4 9/32 5/16 11/32 3/8 7/16" ⊕ 1 2 3 ⊖ 4 5,5 6,5 ● 3 4 5 6 ● T20 T27 T30 ⊕ 754-00 ← 55 + 97 mm 2098	2,5-12	22,5-106	130	28	14	211	0,5 N·m / 5 lbf·in + 0,05 N·m	0.968	1957732	753-14

# 763 TORQUE WRENCH DREMOMETER T-FS

pre-set, 5-12 N·m

**Use:**

- > Power-saving application for torques which are usually in the range of torque screwdrivers
- > E.g. securing modules on solar power systems, tool supports etc.; wherever the torques are too large for classic torque screwdrivers

**Features:**

- > Torque wrench series with 8 pre-set models for serial production
- > For controlled clockwise tightening
- > Working accuracy in accordance with DIN EN ISO 6789:2003 Type II Class E (+/- 6%)
- > Lightweight and robust - housing made of a high-quality aluminium alloy
- > With certificate acc. to DIN EN ISO 6789:2003, traceable via in-house DAKKS laboratory to national standards

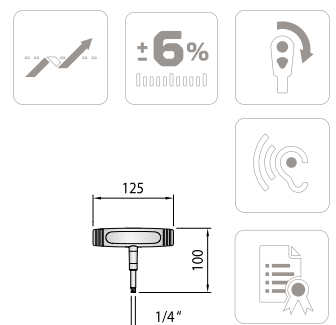

Special ranges are available on request

1/4"	6.3	pre-set value	Weight	Code	No.
1/4	6.3	5 N·m	0.241	1947958	763-05
1/4	6.3	6 N·m	0.241	1947966	763-06
1/4	6.3	7 N·m	0.241	1947974	763-07
1/4	6.3	8 N·m	0.241	1947990	763-08
1/4	6.3	9 N·m	0.241	1948008	763-09
1/4	6.3	10 N·m	0.241	1948016	763-10
1/4	6.3	11 N·m	0.241	1948024	763-11
1/4	6.3	12 N·m	0.241	1948032	763-12

## DREMOMETER Z

### TECHNICAL INFORMATION Z

- > The large cross-section of the spigot end transfers a maximum torque. "Quick-change system" with a locking pin mechanism guarantees that work takes place flexibly and rapidly.
- > Ideal for bolted connections in cramped and hard-to-access locations. Depending on how the torque wrench is used, it is possible to work both in the forward direction and also to the side. For anti-clockwise tightening, simply turn the torque wrench through 180°



## 8460 Z - 8471 Z TORQUE WRENCH DREMOMETER Z WITH QUICK-FITTING CHANGE

8-1000 N·m / 70 lbf·in - 730 lbf·ft

- > Classified to DIN EN ISO 6789:2003 Type II Class A, with a factory certificate. Working accuracy: +/- 3 % tolerance of scale set torque. The specification of the standard (+/- 4 %) is exceeded.
- > Lightweight yet robust (as the housing is made of an aluminium alloy) and resilient, very workshop-friendly
- > Depending on the application, access is possible from the front (e.g. open-end fitting) or side (e.g. reversible ratchet and socket)
- > Force to be applied in the middle of the handgrip only - do not use an extension tube as otherwise, inaccuracies can evolve (except for model DXZ where the DREMOMETER has been calibrated and adjusted using the extension tube)
- > Operation only with end fittings with standardised depth gauges, otherwise inaccuracies can arise. Keep the depth gauges on the certificate in mind. Only use original GEDORE accessories.
- > Large drive cross-section transfers maximum torques
- > Extremely low wear attributable to reduced forces in the lever mechanism
- > Forged lever chain from our own quality forge
- > Maximum precision even when subjected to extreme continuous use
- > Long life cycles and tool lives
- > Easy operation - fast and safe torque tightening
- > Easy adjustment thanks to attractive adjusting button secured against loss at the end of the handle
- > With certificate acc. to DIN EN ISO 6789, traceable via in-house DAKKS laboratory to national standards



AZ



DXZ



CZ

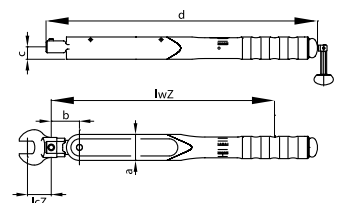

Type	Ø	N·m	lbf·in	lbf·ft		lwZ	lcZ	a	b	c	d		Code	No.
AZ	16	8-40	70-350	—	5 N·m / 50 lbf·in	300.0	32	35	38	16.5	366	1.000	7703610	8460-01
BZ	16	25-120	—	18-90	5 N·m / 5 lbf·ft	411.5	32	35	38	16.5	489	1.450	7704260	8461-01
CZ	16	80-400	—	60-300	5 N·m / 5 lbf·ft	567.0	32	35	38	16.5	645	2.000	7704340	8462-01
DZ	22	140-620	—	100-450	10 N·m / 10 lbf·ft	767.5	56	45	49	17.5	846	3.000	7703020	8463-10
DXZ	28	520-1000	—	380-730	10 N·m / 10 lbf·ft	1,221.0	75	45	57	17.5	1319	5.500	1251341	8471-01

## DREMOMETER SE



### TECHNICAL INFORMATION QUICK-FITTING CHANGE

› Quick-change system with pin locking guarantees flexible and swift working methods. Ideal for installations in confined and poorly accessible spaces. Depending on the application for the DREMOMETER SE, access is possible from the front and side.



On request, all torque wrenches can be factory pre-set **-at extra charge-**. When ordering, please specify the N-m value.



## 8480 SE - 8482 SE TORQUE WRENCH DREMOMETER SE WITH QUICK-FITTING CHANGE

8-400 N·m / 70 lbf·in - 300 lbf·ft

- › Classified to DIN EN ISO 6789:2003 Type II Class A, with a factory certificate. Working accuracy: +/- 3% tolerance of scale set torque. The specification of the standard (+/- 4%) is exceeded.
- › Lightweight yet robust (as the housing is made of an aluminium alloy) and resilient, very workshop-friendly
- › Drive offers extensive range of accessories
- › Depending on the application, access is possible from the front (e.g. rectangular open-end fitting) or side (e.g. reversible ratchet and socket)
- › Force to be applied in the middle of the handgrip only - do not use an extension tube as otherwise, inaccuracies can arise
- › Operation only with end fittings otherwise inaccuracies can arise. Keep the depth gauges on the certificate in mind. Only use original GEDORE accessories.
- › Extremely low wear attributable to reduced forces in the lever mechanism

- › Forged lever chain from our own quality forge
- › Maximum precision even when subjected to extreme continuous use
- › Long life cycles and tool lives
- › Easy operation - fast and safe torque tightening
- › Easy adjustment thanks to attractive adjusting button secured against loss at the end of the handle
- › With certificate acc. to DIN EN ISO 6789, traceable via in-house DAKKS laboratory to national standards



A-SE



B-SE



C-SE

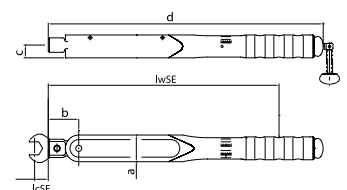

Type	mm	N-m	lbf·in	lbf·ft	mm	lwSE	lcSE	a	b	c	d	mm	Code	No.
A-SE	9 x 12	8-40	70-350	-	5 N-m / 50 lbf·in	302.0	17.5	35	40	16.5	361	0.950	7714060	8480-01
B-SE	9 x 12	25-120	-	18-90	5 N-m / 5 lbf·ft	413.5	17.5	35	40	16.5	484	1.250	7714140	8481-01
C-SE	14 x 18	80-400	-	60-300	5 N-m / 5 lbf·ft	582.0	25.0	35	53	16.5	653	1.700	7714220	8482-01



# DREMOMETER A+S

## 7554 AM A+S - 7572 F A+S TORQUE WRENCH DREMOMETER A+S

with pre-set value locking and safety device (A+S)

### Technical advantage/function:

- > **Pre-set value locking and safety device (A+S) eliminates the possibility of unintentional or manipulated adjustment**, thereby representing more process reliability of the user
- > Classified to DIN EN ISO 6789:2003 Type II Class A, with a factory certificate. Working accuracy: +/- 3 % tolerance of scale set torque. The specification of the standard (+/- 4 %) is exceeded.
- > Lightweight and robust (as housing is made of an aluminium alloy), very workshop-friendly
- > No inaccuracies whether used with both hands or held away from the handle (as for standard torque wrenches). Both the square drive and fulcrum are on an axis which ensures a high degree of user safety; can be extended to reduce the user's working load.
- > Extremely low wear attributable to reduced forces in a unique lever mechanism
- > Forged lever chain from our own quality forge
- > Maximum precision even when subjected to extreme continuous use
- > Long life cycles and tool lives
- > Easy operation - fast and safe torque tightening
- > Single- and double-square drive for controlled bi-directional tightening

### Use:

- > Controlled screw tightening in the range 6 - 3000 N-m
- > For use in almost all industrial manufacturing areas

### Features:

- > With certificate acc. to DIN EN ISO 6789, traceable via in-house DAKKS laboratory to national standards
- > Automatic short-path actuation with tactile impulse and audible signal
- > Dual scale with corresponding scale graduation (see table)
- > Type B, BC, C with push-button release
- > **Pre-set DREMOMETER for serial production wherever the same value always needs to be applied**
- > **The pre-setting can be made at the factory or by the user on suitable torque testers**
- > **If ordering, please specify the N-m value - if a fixed factory pre-setting is desired (price on request)**



A



B

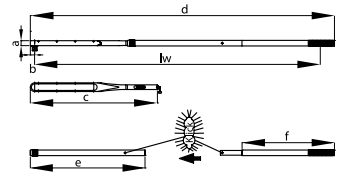

Type	█"	█	N-m	lbf-in	lbf-ft		lw	a	b	c	d	e	f		Code	No.
AM A+S	1/4	6.3	6-30	50-270	–	1 N-m / 10 lbf-in	206.0	30	15.0	256.0	–	–	–	0.580	1210891	7554-01
AML A+S	1/4	6.3	6-30	50-270	–	1 N-m / 10 lbf-in	206.0	30	15.0	256.0	–	–	–	0.580	1210904	7559-01
A A+S	3/8	10.0	8-40	70-350	–	5 N-m / 50 lbf-in	262.0	30	17.5	326.5	–	–	–	1.000	7708920	7560-01
AL A+S	3/8	10.0	8-40	70-350	–	5 N-m / 50 lbf-in	262.0	30	17.5	326.5	–	–	–	1.000	1210939	7565-01
B A+S	1/2	12.5	25-120	–	18-90	5 N-m / 5 lbf-ft	373.0	30	17.5	450.0	–	–	–	1.500	7709060	7561-01
BL A+S	1/2	12.5	25-120	–	18-90	5 N-m / 5 lbf-ft	373.0	30	17.5	450.0	–	–	–	1.500	1210947	7566-01
BC A+S	1/2	12.5	40-200	–	30-150	5 N-m / 5 lbf-ft	463.0	30	17.5	539.0	–	–	–	1.400	1211013	7573-00
BCL A+S	1/2	12.5	40-200	–	30-150	5 N-m / 5 lbf-ft	463.0	30	17.5	539.0	–	–	–	1.300	1427113	7578-00
CA A+S	1/2	12.5	60-300	–	45-220	5 N-m / 5 lbf-ft	529.0	30	17.5	605.0	–	–	–	2.000	7709650	7562-10
CLA A+S	1/2	12.5	60-300	–	45-220	5 N-m / 5 lbf-ft	529.0	30	17.5	605.0	–	–	–	2.000	1210955	7567-10
CD A+S	3/4	20.0	80-360	–	60-260	5 N-m / 5 lbf-ft	624.0	30	22.5	705.5	–	–	–	2.400	1210998	7570-10
CDL A+S	3/4	20.0	80-360	–	60-260	5 N-m / 5 lbf-ft	624.0	30	22.5	705.5	–	–	–	2.400	1211021	7575-10
DSA A+S	3/4	20.0	110-550	–	80-400	10 N-m / 10 lbf-ft	719.0	35	22.5	800.0	–	–	–	2.900	1427164	7574-10
DSL A+S	3/4	20.0	110-550	–	80-400	10 N-m / 10 lbf-ft	719.0	35	22.5	800.0	–	–	–	2.900	1427148	7579-10
DA A+S	3/4	20.0	155-760	–	115-560	10 N-m / 10 lbf-ft	719.0	35	22.5	800.0	–	–	–	3.200	1210921	7563-10
DL A+S	3/4	20.0	155-760	–	115-560	10 N-m / 10 lbf-ft	719.0	35	22.5	800.0	–	–	–	3.200	1210971	7568-10
DRA A+S	3/4	20.0	155-760	–	115-560	10 N-m / 10 lbf-ft	1,290.5	35	22.5	800.0	1403	762	–	5.000	1210912	7563-01
DRL A+S	3/4	20.0	155-760	–	115-560	10 N-m / 10 lbf-ft	1,290.5	35	22.5	800.0	1403	762	–	5.000	1210963	7568-01
DX A+S	3/4	20.0	520-1000	–	380-730	10 N-m / 10 lbf-ft	1,290.5	35	22.5	800.0	1403	762	–	5.600	1211005	7571-01
DXL A+S	3/4	20.0	520-1000	–	380-730	10 N-m / 10 lbf-ft	1,290.5	35	22.5	800.0	1403	762	–	5.600	1211048	7576-01
EKA A+S	1	25.0	600-1500	–	–	25 N-m	1,473.0	40	30.0	920.0	1608	925	–	10.800	2311321	7581-01
EKL A+S	1	25.0	600-1500	–	–	25 N-m	1,473.0	40	30.0	920.0	1608	925	–	10.800	2311348	7586-01
EA A+S	1	25.0	750-2000	–	–	50 N-m	2,213.0	40	30.0	920.0	2353	925	745	11.600	1547232	7564-01
ELA A+S	1	25.0	750-2000	–	–	50 N-m	2,213.0	40	30.0	920.0	2353	925	745	11.600	1547240	7569-01
FA A+S	1.1/2	40.0	1500-3000	–	–	50 N-m	2,309.0	40	35.0	1,025.0	2454	925	745	13.200	1547259	7572-01

# 7460 Z - 7471 Z

## TORQUE WRENCH DREMOMETER Z A+S

with pre-set value locking and safety device (A+S)



**Technical advantage/function:**

- > **Pre-set value locking and safety device (A+S) eliminates the possibility of unintentional or manipulated adjustment**, thereby representing more process reliability of the user
- > Classified to DIN EN ISO 6789:2003 Type II Class A, with a factory certificate. Working accuracy: +/- 3 % tolerance of scale set torque. The specification of the standard (+/- 4 %) is exceeded.
- > Lightweight yet robust (as the housing is made of an aluminium alloy) and resilient, very workshop-friendly
- > Depending on the application, access is possible from the front (e.g. open-end fitting) or side (e.g. reversible ratchet and socket)
- > Force to be applied in the middle of the handgrip only - do not use an extension tube as otherwise, inaccuracies can evolve (except for model DXZ where the DREMOMETER has been calibrated and adjusted using the extension tube)
- > Operation only with end fittings with standardised depth gauges, otherwise inaccuracies can arise. Keep the depth gauges on the certificate in mind. Only use original GEDORE accessories.
- > Large drive cross-section transfers maximum torques
- > Extremely low wear attributable to reduced forces in the lever mechanism

- > Forged lever chain from our own quality forge
- > Maximum precision even when subjected to extreme continuous use
- > Long life cycles and tool lives
- > Easy operation - fast and safe torque tightening
- > Easy adjustment thanks to attractive adjusting button secured against loss at the end of the handle
- > With certificate acc. to DIN EN ISO 6789, traceable via in-house DAKS laboratory to national standards
- > **Pre-set DREMOMETER for serial production wherever the same value always needs to be applied**
- > **The pre-setting can be made at the factory or by the user on suitable torque testers**
- > **If ordering, please specify the N-m value - if a fixed factory pre-setting is desired (price on request)**

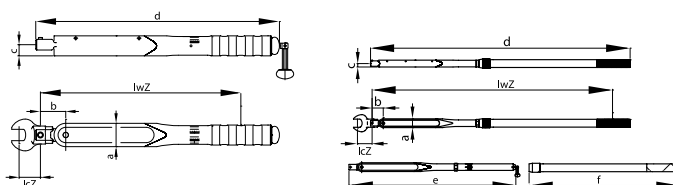

Type	∅	N-m	lbf-in	lbf-ft		lwZ	lcZ	a	b	c	d		Code	No.
AZ A+S	16	8-40	70-350	–	5 N-m / 50 lbf-in	300.0	32	35	38	16.5	354.0	1.000	1427067	7460-01
BZ A+S	16	25-120	–	18-90	5 N-m / 5 lbf-ft	411.5	32	35	38	16.5	477.5	1.450	1427075	7461-01
CZ A+S	16	80-400	–	60-300	5 N-m / 5 lbf-ft	567.0	32	35	38	16.5	633.0	2.000	1225669	7462-01
DZ A+S	22	140-620	–	105-450	10 N-m / 10 lbf-ft	767.5	56	45	49	17.5	834.5	3.000	1427083	7463-10
DXZ A+S	28	520-1000	–	380-730	10 N-m / 10 lbf-ft	1,221.0	75	45	57	17.5	1,319.0	5.500	1521977	7471-01

8791 - 8798

>317 - 321



# 7480 SE - 7482 SE TORQUE WRENCH DREMOMETER SE A+S

with pre-set value locking and safety device (A+S)

**Technical advantage/function:**

- > **Pre-set value locking and safety device (A+S) eliminates the possibility of unintentional or manipulated adjustment**, thereby representing more process reliability of the user
- > Classified to DIN EN ISO 6789:2003 Type II Class A, with a factory certificate. Working accuracy: +/- 3% tolerance of scale set torque. The specification of the standard (+/- 4%) is exceeded.
- > Lightweight yet robust (as the housing is made of an aluminium alloy) and resilient, very workshop-friendly
- > Drive offers extensive range of accessories
- > Depending on the application, access is possible from the front (e.g. rectangular open-end fitting) or side (e.g. reversible ratchet and socket)
- > Force to be applied in the middle of the handgrip only - do not use an extension tube as otherwise, inaccuracies can arise
- > Operation only with end fittings otherwise inaccuracies can arise. Keep the depth gauges on the certificate in mind. Only use original GEDORE accessories.
- > Extremely low wear attributable to reduced forces in the lever mechanism
- > Forged lever chain from our own quality forge
- > Maximum precision even when subjected to extreme continuous use
- > Long life cycles and tool lives
- > Easy operation - fast and safe torque tightening
- > Easy adjustment thanks to attractive adjusting button secured against loss at the end of the handle
- > With certificate acc. to DIN EN ISO 6789, traceable via in-house DAkkS laboratory to national standards
- > **Pre-set DREMOMETER for serial production wherever the same value always needs to be applied**
- > **The pre-setting can be made at the factory or by the user on suitable torque testers**
- > **If ordering, please specify the N-m value - if a fixed factory pre-setting is desired (price on request)**

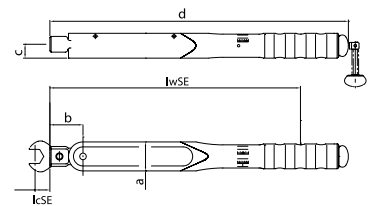

Type	□mm	N-m	lbf-in	lbf-ft	📏	lwSE	lcSE	a	b	c	d	↕	Code	No.
<b>A-SE A+S</b>	9 x 12	8-40	70-350	–	5 N-m / 50 lbf-in	302.0	17.5	35	40	16.5	350	0.950	1427059	7480-01
<b>B-SE A+S</b>	9 x 12	25-120	–	18-90	5 N-m / 5 lbf-ft	413.5	17.5	35	40	16.5	474	1.250	1427091	7481-01
<b>C-SE A+S</b>	14 x 18	80-400	–	60-300	5 N-m / 5 lbf-ft	582.0	25.0	35	53	16.5	642	1.700	1427105	7482-01

7112 - 7918

> 322 - 326



# DREMASTER® DMK

Robust torque wrench with square drive and integrated ratchet-head function for controlled bi-directional tightening and interchangeable mushroom head with push-button release.

**+** **Zinc-plated ratchet head**  
All 1/2" square drives of the DREMASTER® DMK-series have a black plastic cap - also referred to as a mushroom head. This mushroom head prevents an unintentional pulling out of the whole square drive when changing the nut socket.

**+** **Automatic actuation**  
The DREMASTER® DMK actuates with a clear tactile impulse and audible signal and is immediately ready for operation again.



**+** **Robust steel tube**  
With high corrosion protection, chrome-plated, satin powder-coated.

**+** **± 3%**  
0000000000



Classified to DIN EN ISO 6789:2003 Type II Class A, with a factory certificate allowing for operations to be traced back. Calibrated to a permitted +/- 3 % deviation and better. The specifications of the standard (+/- 4 %) are exceeded.

 **Technical information**  
Anti-loss attachment

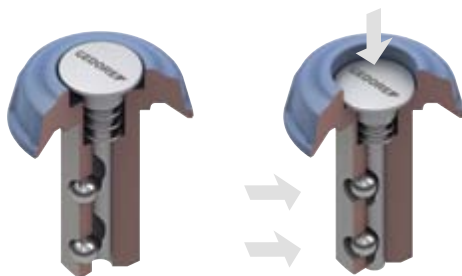

## Function

**In order to change the turning direction of the DREMASTER® DMK:**  
Press on the push-button with your thumb and take out the mushroom head, turn the wrench and re-insert the square drive.

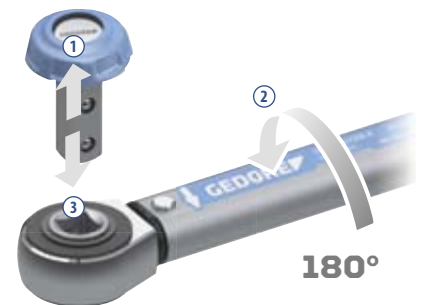

## All the benefits at a single glance

- > Additional protection of the serial number
- > Concealed setting drill hole
- > Engaging adjusting button with locking reference (lock symbol)
- > Rapid adjustment provision using a separate hexagon allen key
- > Mushroom head with release button
- > Plastic grip with a user aid
- > Dual scale (main unit with vernier)
- > Change-over switch for selecting the unit
- > At all times only one unit in the viewing area (N-m or lbf-ft)
- > Controlled safety via in-house DAKkS test laboratory

GEDORE Werkzeugfabrik  
84626 Kitzbühel  
Technische Straße 100  
0800-700000 - GEDORE

Werkzeug DEUTSCHLAND  
Tel: +49 (0) 202 234-1000  
Fax: +49 (0) 202 234-9999  
www.gedore.com

Sales INTERNATIONAL  
Tel: +49 (0) 202 234-1000  
Fax: +49 (0) 202 234-9999  
www.gedore.com

**GEDORE**  
Werkzeugfabrik

**Kalibrier - Zertifikat / Calibration Certificate**

Werte / Values		Einheit / Unit		Messwert / Measurement		Toleranz / Tolerance	
Skala / Scale	Einheit / Unit	Wert / Value	Einheit / Unit	Skala / Scale	Einheit / Unit	Wert / Value	Einheit / Unit
0	Nm	0	Nm	0	Nm	± 0,5	Nm
10	Nm	10	Nm	10	Nm	± 0,5	Nm
20	Nm	20	Nm	20	Nm	± 0,5	Nm
30	Nm	30	Nm	30	Nm	± 0,5	Nm
40	Nm	40	Nm	40	Nm	± 0,5	Nm
50	Nm	50	Nm	50	Nm	± 0,5	Nm
60	Nm	60	Nm	60	Nm	± 0,5	Nm
70	Nm	70	Nm	70	Nm	± 0,5	Nm
80	Nm	80	Nm	80	Nm	± 0,5	Nm
90	Nm	90	Nm	90	Nm	± 0,5	Nm
100	Nm	100	Nm	100	Nm	± 0,5	Nm
110	Nm	110	Nm	110	Nm	± 0,5	Nm
120	Nm	120	Nm	120	Nm	± 0,5	Nm
130	Nm	130	Nm	130	Nm	± 0,5	Nm
140	Nm	140	Nm	140	Nm	± 0,5	Nm
150	Nm	150	Nm	150	Nm	± 0,5	Nm
160	Nm	160	Nm	160	Nm	± 0,5	Nm
170	Nm	170	Nm	170	Nm	± 0,5	Nm
180	Nm	180	Nm	180	Nm	± 0,5	Nm
190	Nm	190	Nm	190	Nm	± 0,5	Nm
200	Nm	200	Nm	200	Nm	± 0,5	Nm
210	Nm	210	Nm	210	Nm	± 0,5	Nm
220	Nm	220	Nm	220	Nm	± 0,5	Nm
230	Nm	230	Nm	230	Nm	± 0,5	Nm
240	Nm	240	Nm	240	Nm	± 0,5	Nm
250	Nm	250	Nm	250	Nm	± 0,5	Nm
260	Nm	260	Nm	260	Nm	± 0,5	Nm
270	Nm	270	Nm	270	Nm	± 0,5	Nm
280	Nm	280	Nm	280	Nm	± 0,5	Nm
290	Nm	290	Nm	290	Nm	± 0,5	Nm
300	Nm	300	Nm	300	Nm	± 0,5	Nm
310	Nm	310	Nm	310	Nm	± 0,5	Nm
320	Nm	320	Nm	320	Nm	± 0,5	Nm
330	Nm	330	Nm	330	Nm	± 0,5	Nm
340	Nm	340	Nm	340	Nm	± 0,5	Nm
350	Nm	350	Nm	350	Nm	± 0,5	Nm
360	Nm	360	Nm	360	Nm	± 0,5	Nm
370	Nm	370	Nm	370	Nm	± 0,5	Nm
380	Nm	380	Nm	380	Nm	± 0,5	Nm
390	Nm	390	Nm	390	Nm	± 0,5	Nm
400	Nm	400	Nm	400	Nm	± 0,5	Nm
410	Nm	410	Nm	410	Nm	± 0,5	Nm
420	Nm	420	Nm	420	Nm	± 0,5	Nm
430	Nm	430	Nm	430	Nm	± 0,5	Nm
440	Nm	440	Nm	440	Nm	± 0,5	Nm
450	Nm	450	Nm	450	Nm	± 0,5	Nm
460	Nm	460	Nm	460	Nm	± 0,5	Nm
470	Nm	470	Nm	470	Nm	± 0,5	Nm
480	Nm	480	Nm	480	Nm	± 0,5	Nm
490	Nm	490	Nm	490	Nm	± 0,5	Nm
500	Nm	500	Nm	500	Nm	± 0,5	Nm
510	Nm	510	Nm	510	Nm	± 0,5	Nm
520	Nm	520	Nm	520	Nm	± 0,5	Nm
530	Nm	530	Nm	530	Nm	± 0,5	Nm
540	Nm	540	Nm	540	Nm	± 0,5	Nm
550	Nm	550	Nm	550	Nm	± 0,5	Nm
560	Nm	560	Nm	560	Nm	± 0,5	Nm
570	Nm	570	Nm	570	Nm	± 0,5	Nm
580	Nm	580	Nm	580	Nm	± 0,5	Nm
590	Nm	590	Nm	590	Nm	± 0,5	Nm
600	Nm	600	Nm	600	Nm	± 0,5	Nm
610	Nm	610	Nm	610	Nm	± 0,5	Nm
620	Nm	620	Nm	620	Nm	± 0,5	Nm
630	Nm	630	Nm	630	Nm	± 0,5	Nm
640	Nm	640	Nm	640	Nm	± 0,5	Nm
650	Nm	650	Nm	650	Nm	± 0,5	Nm
660	Nm	660	Nm	660	Nm	± 0,5	Nm
670	Nm	670	Nm	670	Nm	± 0,5	Nm
680	Nm	680	Nm	680	Nm	± 0,5	Nm
690	Nm	690	Nm	690	Nm	± 0,5	Nm
700	Nm	700	Nm	700	Nm	± 0,5	Nm
710	Nm	710	Nm	710	Nm	± 0,5	Nm
720	Nm	720	Nm	720	Nm	± 0,5	Nm
730	Nm	730	Nm	730	Nm	± 0,5	Nm
740	Nm	740	Nm	740	Nm	± 0,5	Nm
750	Nm	750	Nm	750	Nm	± 0,5	Nm
760	Nm	760	Nm	760	Nm	± 0,5	Nm
770	Nm	770	Nm	770	Nm	± 0,5	Nm
780	Nm	780	Nm	780	Nm	± 0,5	Nm
790	Nm	790	Nm	790	Nm	± 0,5	Nm
800	Nm	800	Nm	800	Nm	± 0,5	Nm
810	Nm	810	Nm	810	Nm	± 0,5	Nm
820	Nm	820	Nm	820	Nm	± 0,5	Nm
830	Nm	830	Nm	830	Nm	± 0,5	Nm
840	Nm	840	Nm	840	Nm	± 0,5	Nm
850	Nm	850	Nm	850	Nm	± 0,5	Nm
860	Nm	860	Nm	860	Nm	± 0,5	Nm
870	Nm	870	Nm	870	Nm	± 0,5	Nm
880	Nm	880	Nm	880	Nm	± 0,5	Nm
890	Nm	890	Nm	890	Nm	± 0,5	Nm
900	Nm	900	Nm	900	Nm	± 0,5	Nm
910	Nm	910	Nm	910	Nm	± 0,5	Nm
920	Nm	920	Nm	920	Nm	± 0,5	Nm
930	Nm	930	Nm	930	Nm	± 0,5	Nm
940	Nm	940	Nm	940	Nm	± 0,5	Nm
950	Nm	950	Nm	950	Nm	± 0,5	Nm
960	Nm	960	Nm	960	Nm	± 0,5	Nm
970	Nm	970	Nm	970	Nm	± 0,5	Nm
980	Nm	980	Nm	980	Nm	± 0,5	Nm
990	Nm	990	Nm	990	Nm	± 0,5	Nm
1000	Nm	1000	Nm	1000	Nm	± 0,5	Nm

**+** **Additional protection of the serial number**  
Concealed setting drill hole = secured adjusting/ setting system Serial number on the wrench and on the certificate for unambiguous product identification, traceable via in-house DAKKS laboratory to national standards

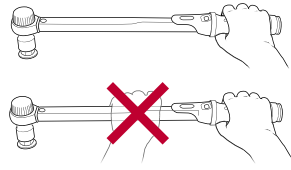

**+** **Handgrip with user aid**  
Grey plastic handgrip, new ergonomically enhanced shape, with an indentation in the middle of the handgrip. User aid and reference points for calibration.

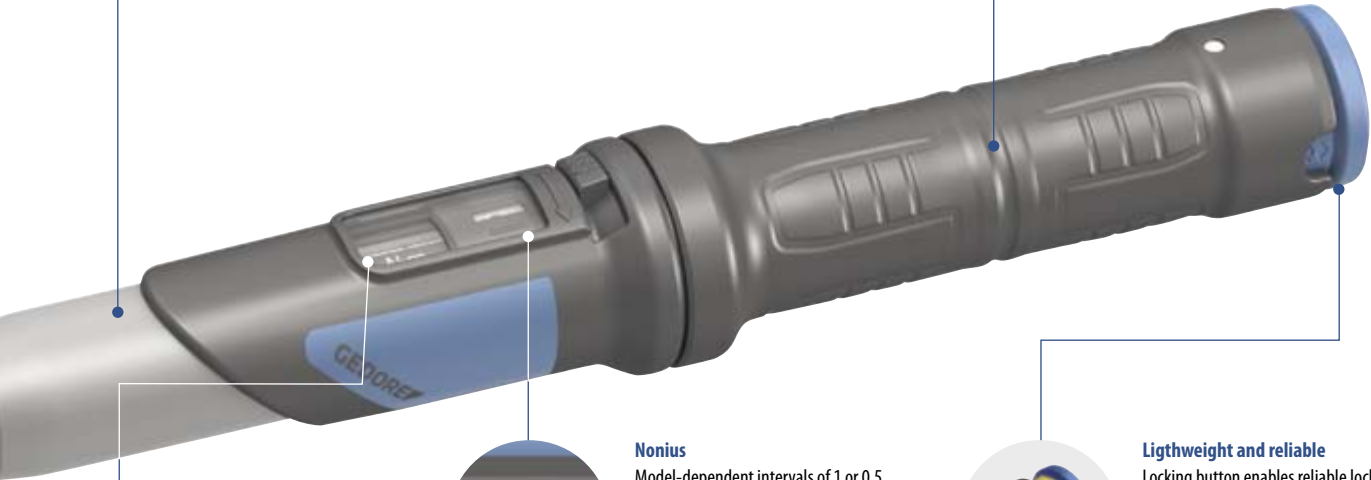

**Nonius**  
Model-dependent intervals of 1 or 0.5 N-m allow very accurate settings.



**Lighthouse and reliable**  
Locking button enables reliable locking of the torque setting. "Torque adjustable" reference by means of opened lock symbol. Provision for rapid setting from the separate hexagon allen key fixture.

**+** **Dual scale with main and alternative unit (N-m/lbf-ft).**  
Main unit N-m with vernier. At all times only one unit in the viewing area = avoids any reading errors. Change-over switch next to the scale for straightforward unit selection.



## DREMASTER® DMUK

Torque wrench with square drive and integrated ratchet-function for controlled clockwise tightening



**+** **Robust tubular steel**  
With high corrosion protection, satin powder-coated, with zinc-plated ratchet head

**+** With 1/2" square drive and integrated lever-change reversible ratchet function for controlled clockwise tightening

Switch the lever of the reversible ratchet to correspond with the desired direction, clockwise or anti-clockwise.



DMK 1/2" - 3/4" 20-850 N-m



DMUK 1/2" 20-300 N-m



DMZ 16 22 20-850 N-m



DMSE 9x12 14x18 20-400 N-m

# DMK TORQUE WRENCH DREMASTER® K

20-850 N·m

**Use:**

- > Controlled screw tightening in the most common range of 20 - 850 N·m / 15 - 630 lbf·ft (guide for screws M7-10.9 to M24-8.8, M30-5.6)
- > Adjustable, releasing and sturdy tubular torque wrench with integrated ratchet and with square drive for industry and the trades

**Features:**

- > Classified to DIN EN ISO 6789:2003 Type II Class A, with a factory certificate allowing for operations to be traced back. Calibrated to a permitted +/- 3 % deviation and better. The specifications of the standard (+/- 4 %) are exceeded.
- > For controlled bi-directional tightening. DMUK only for controlled clockwise-tightening
- > Models DMK: 1/2" mushroom head interchangeable square with push-button releasing and a ball-locking mechanism. From Model No. DMK 400 with 3/4" push-through square and a pin-locking mechanism

- > Sturdy, varnished tubular steel construction, with zinc-plated ratchet head and top-grade plastic parts
- > Ergonomically shaped plastic grip with calibration aid
- > Change-over between N·m main scale and lbf·ft ancillary scale to avoid reading errors when setting the torque wanted
- > With micrometre scale for main N·m scale for setting interim values
- > Release system triggers a tactile and audible signal
- > Ergonomic system for torque adjustment with reference symbol
- > Provision for rapid setting with hexagon allen key, not included
- > Secured adjusting/setting system

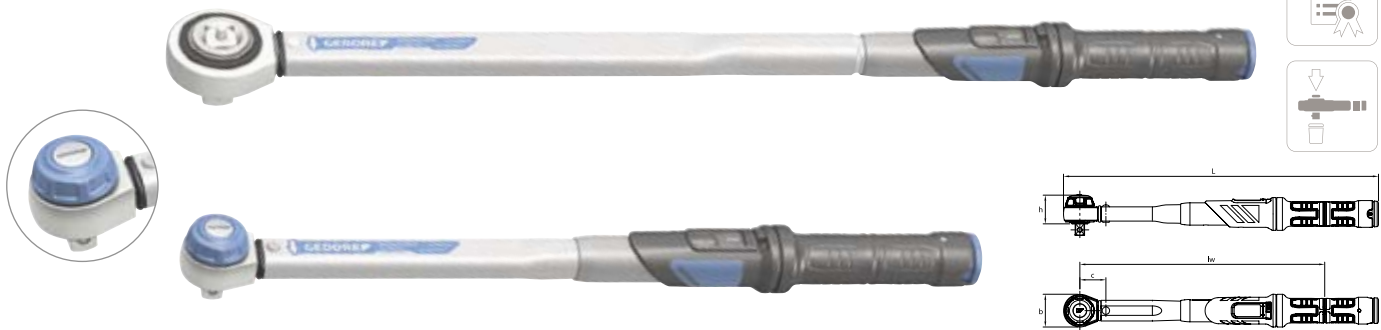

"	■	N·m	lbf·ft	Scale	Scale ring	L	lw	c	h	b	h <sub>1</sub>	Code	No.
1/2	12.5	20-100	15-75	5 N·m	0,5 N·m	423.5	329.2	35	38.5	44	1.250	2641232	DMK 100
1/2	12.5	40-200	30-150	10 N·m	1 N·m	514.5	420.2	35	38.5	44	1.400	2641240	DMK 200
1/2	12.5	60-300	45-220	10 N·m	1 N·m	606.4	511.1	35	38.5	46	1.431	2641259	DMK 300
3/4	20.0	80-400	60-300	10 N·m	1 N·m	714.8	608.9	46	38.0	67	2.488	2641267	DMK 400
3/4	20.0	110-550	80-405	10 N·m	1 N·m	953.2	846.4	52	38.0	69	3.940	2641275	DMK 550
3/4	20.0	150-750	110-550	10 N·m	1 N·m	1,228.2	1,121.4	327	38.0	69	5.020	2641283	DMK 750
3/4	20.0	250-850	185-630	10 N·m	1 N·m	1,375.2	1,268.4	474	38.0	69	5.325	2641291	DMK 850

# GDMK TORQUE WRENCH SET DREMASTER® K

- > The DREMASTER® DMK as a practical tool set
- > Most-widely-used tools in a robust sheet-metal case
- > Clearly organised - everything always easily accessible
- > With foam-material inlay modules (on request, these can be customised or extended individually)



"	■	N·m	lbf·ft	Contents	kg	Code	No.
1/2	12.5	20-100	15-75	No. DMK 100 in sheet-metal case ○ 10 13 17 19 24 ← 125 mm and 1/2" square drive	4.4	2641593	GDMK 100
1/2	12.5	40-200	30-150	No. DMK 200 in sheet-metal case ○ 10 13 17 19 24 ← 125 mm and 1/2" square drive	5.7	2641607	GDMK 200
1/2	12.5	60-300	45-220	No. DMK 300 in sheet-metal case ○ 17 19 24 27 ← 125 mm and 1/2" square drive	5.8	2641615	GDMK 300
3/4	20.0	80-400	60-300	No. DMK 400 in sheet-metal case ○ 18 19 24 27 ← 200 mm and 3/4" square drive	6.5	2641623	GDMK 400



# DMUK TORQUE WRENCH DREMASTER® UK

20-300 N·m / 15-220 lbf·ft

**Use:**

- > Controlled screw tightening in the most common range of 20 - 300 N·m / 15 - 220 lbf·ft (guide for screws M7-10.9 to M24-8.8, M30-5.6)
- > Adjustable, releasing and sturdy tubular torque wrench with integrated ratchet and with square drive for industry and the trades

**Features:**

- > Classified to DIN EN ISO 6789:2003 Type II Class A, with a factory certificate. Working accuracy: +/- 3 % tolerance of scale set torque. The specification of the standard (+/- 4 %) is exceeded.
- > For controlled clockwise tightening
- > Models DMUK: With 1/2" reversible ratchet
- > Sturdy, varnished tubular steel construction, with zinc-plated ratchet head and top-grade plastic parts
- > Ergonomically shaped plastic grip with calibration aid

- > Change-over between N·m main scale and lbf·ft ancillary scale to avoid reading errors when setting the torque wanted
- > With micrometre scale for main N·m scale for setting interim values
- > Release system triggers a tactile and audible signal
- > Ergonomic system for torque adjustment with reference symbol
- > Provision for rapid setting with hexagon allen key, not included
- > Secured adjusting/setting system

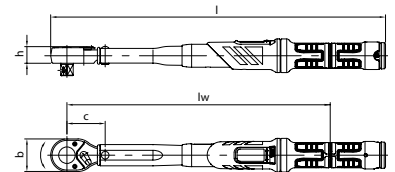

"		N·m	lbf·ft		Scale ring	L	lw	c	h	b	kg	Code	No.
1/2	12.5	20-100	15-75	5 N·m	0,5 N·m	437.7	344.2	50	22.0	42.5	1.232	2641305	DMUK 100
1/2	12.5	40-200	30-150	10 N·m	1 N·m	529.7	435.2	50	22.0	42.5	1.400	2641313	DMUK 200
1/2	12.5	60-300	45-220	10 N·m	1 N·m	619.6	526.1	50	22.0	42.5	1.623	2641348	DMUK 300

## FUNCTION

**In order to change the turning direction of the TORCOFIX K:**

- > Press on the protruding square drive with your thumb and take out the mushroom head, turn the wrench and re-insert the square drive.

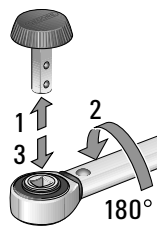

## DMKPK MUSHROOM HEAD DREMASTER® DMK

- > With 1/2" output square drive with ball locking device and release button
- > Made of chrome-vanadium steel, zinc-plated
- > With blue mushroom head made of polypropylene



## 3294 COUPLER 3/4"

- > Acc. to DIN 3122, ISO 3315
- > For hand-operated sockets with square drive as per DIN 3120, ISO 1174, with locking pin
- > Chrome-vanadium steel, chrome-plated



"		mm	kg	Code	No.	"		"		kg	Code	No.
3/4	20	51.5	0.133	6279090	3294	1/2	12.5	1/2	12.5	0.064	2551829	DMKPK 7

# DMZ TORQUE WRENCH DREMASTER® Z

20-850 N·m / 15-630 lbf·ft

**Use:**

- > Controlled screw tightening in the most common range of 20 - 850 N·m / 15 - 630 lbf·ft (guide for screws M7-10.9 to M24-8.8, M30-5.6)
- > Adjustable, releasing and sturdy tubular torque wrench with spigot end for industry and the trades

**Features:**

- > Classified to DIN EN ISO 6789:2003 Type II Class A, with a factory certificate allowing for operations to be traced back. Calibrated to a permitted +/- 3 % deviation and better. The specifications of the standard (+/- 4 %) are exceeded.
- > For controlled bi-directional tightening
- > Sturdy, varnished tubular steel construction, with phosphated spigot end (Ø 16 mm or Ø 22 mm) and high-grade plastic parts
- > Ergonomically shaped plastic grip with calibration aid
- > Change-over between N·m main scale and lbf·ft ancillary scale to avoid reading errors when setting the torque wanted.

- > With micrometre scale for main N·m scale for setting interim values
- > Release system triggers a tactile and audible signal
- > Ergonomic system for torque adjustment with reference symbol
- > Provision for rapid setting with hexagon allen key, not included
- > Secured adjusting/setting system
- > Factory depth gauge: 32 mm (Ø 16 mm) or 56 mm (Ø 22 mm)
- > Operation only with end fittings with standardised depth gauge - otherwise inaccuracies may arise.
- > Depending on the application, access is possible from the front (e.g. open-end fitting) or side (e.g. reversible ratchet and socket)

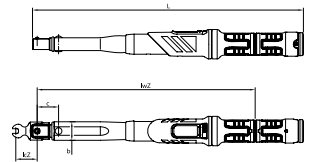

Ø	N·m	lbf·ft	Scale ring	L	lwZ	lcZ	b	c	kg	Code	No.
16	20-100	15-75	5 N·m	405.5	326.2	32	27.5	32	0.998	2641518	DMZ 100
16	40-200	30-150	10 N·m	496.5	417.2	32	27.5	32	1.100	2641526	DMZ 200
16	60-300	45-220	10 N·m	587.4	508.1	32	27.5	32	1.300	2641534	DMZ 300
16	80-400	60-300	10 N·m	677.2	597.9	32	35.0	32	1.790	2641542	DMZ 400
22	110-550	80-405	10 N·m	912.7	831.4	56	36.5	37	3.280	2641550	DMZ 550
22	150-750	110-550	10 N·m	1,193.7	1,121.7	56	38.5	318	4.380	2641569	DMZ 750
22	250-850	185-630	10 N·m	1,340.7	1,259.4	56	38.5	465	5.000	2641577	DMZ 850

# GDMZ TORQUE WRENCH SET DREMASTER® Z

- > The DREMASTER® DMZ as a practical tool set
- > Most-widely-used tools in a robust sheet-metal case
- > Clearly organised - everything always easily accessible
- > With foam-material inlay modules (on request, these can be customised or extended individually)



Ø	N·m	lbf·ft	Contents	kg	Code	No.
16	20-100	15-75	No. DMZ 100 in sheet-metal case 17 19 24 and 1/2" ratchet head	4.5	2641704	GDMZ 100
16	40-200	30-150	No. DMZ 200 in sheet-metal case 17 19 24 and 1/2" ratchet head	5.8	2641712	GDMZ 200
16	60-300	45-220	No. DMZ 300 in sheet-metal case 24 27 30 32 and 1/2" ratchet head	6.5	2641720	GDMZ 300
16	80-400	60-300	No. DMZ 400 in sheet-metal case 24 27 30 32 and 1/2" ratchet head	7.4	2641739	GDMZ 400

# DMSE TORQUE WRENCH DREMASTER® SE

20-400 N·m / 15-300 lbf·ft

**Use:**

- > Controlled screw tightening in the most common range of 20 - 400 N·m / 15 - 300 lbf·ft (guide for screws M7-10.9 to M20-6.9)
- > Adjustable, releasing and sturdy tubular torque wrench with rectangular cavity for industry and the trades

**Features:**

- > Classified to DIN EN ISO 6789:2003 Type II Class A, with a factory certificate allowing for operations to be traced back. Calibrated to a permitted +/- 3 % deviation and better. The specifications of the standard (+/- 4 %) are exceeded.
- > For controlled bi-directional tightening
- > Sturdy, varnished tubular steel construction, with zinc-plated rectangular cavity (9x12 mm or 14x18mm) and high-grade plastic parts
- > Ergonomically shaped plastic grip with calibration aid
- > Change-over between N·m main scale and lbf·ft ancillary scale to avoid reading errors when setting the torque wanted.

- > With micrometre scale for main N·m scale for setting interim values
- > Release system triggers a tactile and audible signal
- > Ergonomic system for torque adjustment with reference symbol
- > Provision for rapid setting with hexagon allen key, not included
- > Secured adjusting/setting system
- > Factory depth gauge: 17.5 mm (9x12 mm) or 25 mm (14x18 mm)
- > Operation only with end fittings with standardised depth gauges, otherwise inaccuracies can arise
- > Depending on the application, access is possible from the front (e.g. open-end fitting) or side (e.g. reversible ratchet and socket)

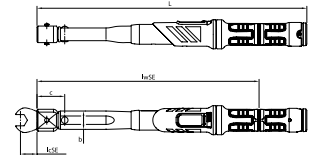

mm	N·m	lbf·ft	Scale ring	Scale ring	L	lWSE	lCSE	b	c	kg	Code	No.
9 x 12	20-100	15-75	5 N·m	0,5 N·m	398.5	326.2	17.5	27.5	32	1.000	2641445	DMSE 100
9 x 12	30-150	22-110	10 N·m	1 N·m	489.5	417.2	17.5	27.5	32	1.160	2641453	DMSE 150
14 x 18	40-200	30-150	10 N·m	1 N·m	499.5	427.2	25.0	27.5	42	1.250	2641461	DMSE 200
14 x 18	60-300	45-220	10 N·m	1 N·m	590.4	518.1	25.0	27.5	42	1.400	2641488	DMSE 300
14 x 18	80-400	60-300	10 N·m	1 N·m	677.2	604.9	25.0	33.0	42	2.000	2641496	DMSE 400

# GDMSE TORQUE WRENCH SET DREMASTER® SE

- > The DREMASTER® DMSE as a practical tool set
- > Most-widely-used tools in a robust sheet-metal case
- > Clearly organised - everything always easily accessible
- > With foam-material inlay modules (on request, these can be customised or extended individually)



mm	N·m	lbf·ft	Contents	kg	Code	No.
9 x 12	20-100	15-75	No. DMSE 100 in sheet-metal case 13 17 19 and 1/2" ratchet head	3.9	2641658	GDMSE 100
9 x 12	30-150	22-110	No. DMSE 150 in sheet-metal case 13 17 19 and 1/2" ratchet head	5.6	2643731	GDMSE 150
14 x 18	40-200	30-150	No. DMSE 200 in sheet-metal case 17 19 24 and 1/2" ratchet head	6.3	2641666	GDMSE 200
14 x 18	60-300	45-220	No. DMSE 300 in sheet-metal case 24 30 32 and 1/2" ratchet head	6.5	2641674	GDMSE 300
14 x 18	80-400	60-300	No. DMSE 400 in sheet-metal case 24 30 32 and 1/2" ratchet head	7.0	2641690	GDMSE 400

# TORCOFIX K

Robust torque wrench with square drive and integrated ratchet-head function for controlled bi-directional tightening.

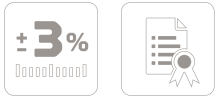

**+** Classified to DIN EN ISO 6789:2003 Type II Class A, with a factory certificate allowing for operations to be traced back. Calibrated to a permitted +/- 3 % deviation and better. The specifications of the standard (+/- 4 %) are exceeded.

Serial number on the wrench and on the certificate for unambiguous product identification, traceable via in-house DAKkS laboratory to national standards



**+** **Chrome-plated ratchet head**  
All 1/4" - 1/2" square drives of the TORCOFIX K-series with mushroom head. This mushroom head prevents an unintentional pulling out of the whole square drive when changing the nut socket.



**+** **Automatic actuation**  
The TORCOFIX actuates with a clear tactile impulse and audible signal and is immediately ready for operation again.

**Robust steel tube**  
With high corrosion protection, chrome-plated, silk-metal.

**+** **Micrometre scale**  
Optimised shape, stable scale frame with red-shaded micrometre scale ring. Model-dependent intervals of 0.025, 0.1, 0.25, 0.5 or 1 N·m allow very accurate settings.

**+** **Lighweight and reliable**  
Locking button enables reliable locking of the torque setting.

**+** **Handgrip with a user aid**  
Black plastic handgrip, new ergonomically enhanced shape, with an indentation in the middle of the handgrip. User aid and reference points for calibration.

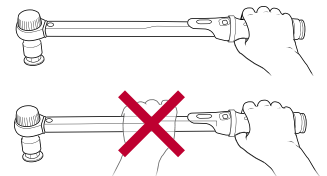

K 1/4 - 3/8 1 - 850 N·m



Z 16 22 2 - 850 N·m



SE 9x12 14x18 2 - 400 N·m

# 4549 - 4550 - 4551 TORQUE WRENCH TORCOFIX K

1-850 N·m / 0.75-630 lbf·ft

**Use:**

- > Controlled screw tightening in the most widely used range of 1 - 850 N·m / 0.75 - 630 lbf·ft (guide for screws M3-6.9 to M24-8.8, M30-5.6)
- > Adjustable, releasing and sturdy tubular torque wrench with integrated ratchet and with square drive for industry and the trades

**Features:**

- > Classified to DIN EN ISO 6789:2003 Type II Class A, with a factory certificate. Working accuracy: +/- 3 % tolerance of scale set torque. The specification of the standard (+/- 4 %) is exceeded.
- > For controlled bi-directional tightening

- > 1/4", 3/8", 1/2" interchangeable mushroom head with ball locking device. As from 3/4" with push through square drive with pin-locking mechanism
- > Sturdy, varnished tubular steel construction, with zinc-plated ratchet head and top-grade plastic parts
- > Ergonomically shaped, convenient black plastic handgrip with calibration aid
- > Dual scale N·m and lbf·ft below a window with a magnifying-glass effect
- > With micrometre scale for main N·m scale for setting interim values
- > Release system triggers a tactile and audible signal
- > Ergonomic system for torque adjustment



4549-02



4550-30

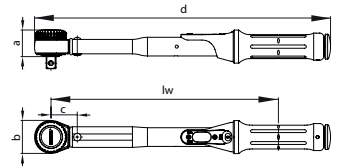

"	■	N·m	lbf·ft	Scale ring	Scale ring	lw	a	b	c	d	kg	Code	No.
1/4	6.3	1-5	0,75-3,7	0,25 N·m	0,025 N·m	146.0	25.3	35	26	224.0	0.323	2201429	4549-00
1/4	6.3	5-25	3,7-18	1 N·m	0,1 N·m	206.5	25.3	35	26	284.5	0.450	1545132	4549-02
3/8	10.0	10-50	7,5-37	2,5 N·m	0,25 N·m	256.5	25.3	35	26	334.5	0.540	1545140	4549-05
1/2	12.5	20-100	15-75	5 N·m	0,5 N·m	303.2	35.9	44	35	394.7	0.900	7601530	4550-10
1/2	12.5	40-200	30-150	10 N·m	1 N·m	394.2	35.9	44	35	485.5	1.100	7601610	4550-20
1/2	12.5	60-300	45-220	10 N·m	1 N·m	485.2	35.9	46	35	577.5	1.300	7601880	4550-30
3/4	20.0	80-400	60-300	10 N·m	1 N·m	583.2	38.0	67	46	686.0	1.860	7674330	4550-40
3/4	20.0	110-550	80-405	10 N·m	1 N·m	853.7	38.0	69	52	957.5	3.560	7674760	4550-55
3/4	20.0	150-750	110-550	10 N·m	1 N·m	1,128.7	38.0	69	327	1,232.5	4.500	1521365	4550-75
3/4	20.0	250-850	185-630	10 N·m	1 N·m	1,275.7	38.0	69	1276	1,379.5	4.700	1950525	4551-85

## FUNCTION

**In order to change the turning direction of the TORCOFIX K:**

- > Press on the protruding square drive with your thumb and take out the mushroom head, turn the wrench and re-insert the square drive.

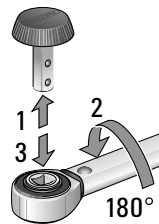

## 4549 - 4550 MUSHROOM HEAD TORCOFIX K

- > With 1/4", 3/8" or 1/2" output square drive with ball locking device
- > Made of chrome-vanadium steel, zinc-plated
- > With blue mushroom head made of polypropylene



4550-865



4550-855

## 3294 COUPLER 3/4"

- > Acc. to DIN 3122, ISO 3315
- > For hand-operated sockets with square drive as per DIN 3120, ISO 1174, with locking pin
- > Chrome-vanadium steel, chrome-plated



"	■	mm	kg	Code	No.
3/4	20	51.5	0.133	6279090	3294

"	□	"	■	mm	kg	Code	No.
3/8" - 1/4"	10.0	1/4	6.3	35	0.021	1545167	4549-875
3/8" - 1/4"	10.0	3/8	10.0	35	0.022	1566385	4549-885
1/2" - 3/8"	12.5	1/2	12.5	44	0.060	7079370	4550-855
1/2" - 3/8"	12.0	3/8	10.0	44	0.060	7079450	4550-865

TORCOFIX Z

TECHNICAL INFORMATION Z



- > The large cross-section of the spigot end transfers a maximum torque. "Quick-change system" with a locking pin mechanism guarantees that work takes place flexibly and rapidly.
- > Ideal for bolted connections in cramped and hard-to-access locations. Depending on how the torque wrench Z is used, it is possible to work both in the forward direction and also to the side. For anti-clockwise tightening, simply turn the torque wrench through 180°



4400 - 4485  
TORQUE WRENCH TORCOFIX Z

5-850 N·m / 3,7-630 lbf·ft

Use:

- > Controlled screw tightening in the most widely used range of 5 - 850 N·m / 3.7 - 550 lbf·ft
- > Adjustable, releasing and sturdy tubular torque wrench with spigot end for industry and the trades

Features:

- > Classified to DIN EN ISO 6789:2003 Type II Class A, with a factory certificate. Working accuracy: +/- 3 % tolerance of scale set torque. The specification of the standard (+/- 4 %) is exceeded.
- > For controlled bi-directional tightening
- > Sturdy, varnished tubular steel construction, with phosphated spigot end (Ø 16 mm or Ø 22 mm) and high-grade plastic parts
- > Ergonomically shaped, convenient black plastic handgrip with calibration aid
- > Dual scale N·m and lbf·ft below a window with a magnifying-glass effect
- > With micrometre scale for main N·m scale for setting interim values
- > Release system triggers a tactile and audible signal

- > Ergonomic system for torque adjustment
- > Factory depth gauges: 32 mm (Ø 16 mm) or 56 mm (Ø 22 mm)
- > Operation only with end fittings with standardised depth gauges, otherwise inaccuracies can arise
- > Depending on the application, access is possible from the front (e.g. open-end fitting) or side (e.g. reversible ratchet and socket)



4400-02



4430-01

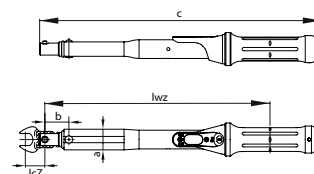

Ø	N·m	lbf·ft	Scale ring	Scale ring	lwZ	lcZ	a	b	c	Weight	Code	No.
16	5-25	3,7-18	1 N·m	0,1 N·m	210.5	32	20.0	30	278.0	0.330	1646168	4400-02
16	10-50	7,5-37	2,5 N·m	0,25 N·m	260.5	32	20.0	30	328.0	0.390	1646176	4405-05
16	20-100	15-75	5 N·m	0,5 N·m	300.2	32	27.5	32	376.5	0.700	7097270	4410-01
16	40-200	30-150	10 N·m	1 N·m	391.2	32	27.5	32	467.5	0.860	7097350	4420-01
16	60-300	45-220	10 N·m	1 N·m	482.2	32	27.5	32	558.5	1.080	7097430	4430-01
16	80-400	60-300	10 N·m	1 N·m	572.2	32	35.0	33	648.5	1.390	7094090	4440-01
22	110-550	80-405	10 N·m	1 N·m	838.7	56	36.5	37	917.0	3.000	7501310	4450-01
22	150-750	110-550	10 N·m	1 N·m	1,119.7	56	38.5	318	1,198.0	4.060	1521381	4475-01
22	250-850	185-630	10 N·m	1 N·m	1,266.7	56	38.0	465	1,345.0	4.430	1997009	4485-01



# TORCOFIX SE

## TECHNICAL INFORMATION - QUICK-FITTING CHANGE (SE)

Quick-change system with pin locking guarantees flexible and swift working methods. Ideal for installations in confined and poorly accessible spaces. Depending on the application for the **TORCOFIX SE**, access is possible from the front and side.



### 4100 - 4301 TORQUE WRENCH TORCOFIX SE

2-400 N·m / 1.5-300 lbf·ft

**Use:**

- > Controlled screw tightening in the most widely used range of 5 - 400 N-m / 3.7 - 300 lbf-ft
- > Adjustable, releasing and sturdy tubular torque wrench with rectangular cavity for industry and the trades

**Features:**

- > Classified to DIN EN ISO 6789:2003 Type II Class A, with a factory certificate. Working accuracy: +/- 3 % tolerance of scale set torque. The specification of the standard (+/- 4 %) is exceeded.
- > For controlled bi-directional tightening
- > Sturdy, varnished tubular steel construction, with zinc-plated rectangular cavity (9x12 mm or 14x18 mm) and high-grade plastic parts
- > Ergonomically shaped, convenient black plastic handgrip with calibration aid
- > Dual scale N-m and lbf-ft below a window with a magnifying-glass effect
- > With micrometre scale for main N-m scale for setting interim values

- > Release system triggers a tactile and audible signal
- > Ergonomic system for torque adjustment
- > Factory depth gauges: 17.5 mm (9x12 mm) or 25 mm (14x18 mm)
- > Operation only with end fittings with standardised depth gauges, otherwise inaccuracies can arise
- > Depending on the application, access is possible from the front (e.g. open-end fitting) or side (e.g. reversible ratchet and socket).



4100-01



4300-01

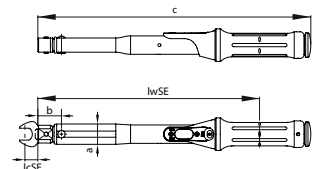

mm	N-m	lbf-ft	مقياس	Scale ring	lwSE	lcSE	a	b	c	±%	Code	No.
9 x 12	5-25	3,7-18	1 N-m	0,1 N-m	212.5	17.5	20.0	32	273.0	0.352	1646192	4101-02
9 x 12	10-50	7,5-37	2,5 N-m	0,25 N-m	262.5	17.5	20.0	32	323.0	0.450	1646206	4101-05
9 x 12	20-100	15-75	5 N-m	0,5 N-m	300.2	17.5	27.5	32	369.5	0.600	7600210	4100-01
9 x 12	30-150	22-110	10 N-m	1 N-m	391.2	17.5	27.5	32	460.5	0.800	1654934	4200-02
14 x 18	40-200	30-150	10 N-m	1 N-m	401.2	25.0	27.5	42	470.5	0.900	7600990	4201-01
14 x 18	60-300	45-220	10 N-m	1 N-m	492.2	25.0	27.5	42	561.5	1.200	7601020	4300-01
14 x 18	80-400	60-300	10 N-m	1 N-m	579.2	25.0	33.0	42	648.5	1.600	7604120	4301-01

## TORCOFIX FS

## 4150 - 4151

## TORQUE WRENCH FOR PRE-SETTING TORCOFIX FS

5-200 N·m

**Use:**

- > Controlled screw tightening in the most widely used range of 5 - 200 N·m without scale
- > Pre-set, releasing and sturdy tubular torque wrench with rectangular cavity for industry and the trades

**Features:**

- > Classified to DIN EN ISO 6789:2003 Type II Class A, with a factory certificate.  
Working accuracy: +/- 3 % tolerance of scale set torque.  
The specification of the standard (+/- 4 %) is exceeded.
- > For controlled bi-directional tightening
- > Sturdy, varnished tubular steel construction, with zinc-plated rectangular cavity (9x12 mm or 14x18 mm)
- > Release system triggers a tactile and audible signal
- > Factory depth gauge: 17.5 mm (9x12 mm) or 25 mm (14x18 mm)
- > Operation only with end fittings with standardised depth gauges, otherwise inaccuracies can arise
- > Depending on the application, access is possible from the front (e.g. open-end fitting) or side (e.g. reversible ratchet and socket).
- > **If ordering, please specify the N·m value - if a fixed factory pre-setting is desired (price on request)**



4150-25



4151-20

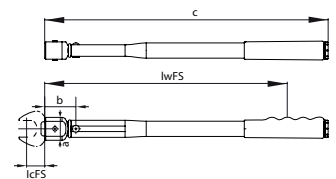

mm	N·m <sub>min/max</sub>	lwFS	lcFS	a	b	c	kg	Code	No.
9 x 12	5 - 25	134	17.5	22	31	186	0.210	7601960	4150-25
9 x 12	10 - 50	194	17.5	22	31	246	0.270	7602180	4150-50
9 x 12	17 - 85	277	17.5	22	31	329	0.340	7602850	4150-85
14 x 18	40 - 200	357	25.0	33	45	410	0.750	7603580	4151-20

## Torque Screwdrivers

# TORQUE SCREWDRIVER TECHNICAL FEATURES

A range of compact and versatile torque screwdrivers with automatically actuating, dial-indicating and measuring torque.



### TYPE PGN

- > Pre-set torque screwdriver without scale for durable and identical value tightening
- > Auto setting
- > With 1/4" female hexagon drive for use with 1/4" hexagon bits as per DIN 3126 - C 6.3



### TYPE FS 755

- > Pre-set torque screwdriver without scale for durable and identical value tightening
- > Auto setting
- > Bidirectional
- > Anodised aluminium handgrip



### TYPE 756

- > Adjustable torque screwdriver with scale ring
- > "Positive-lock"-system
- > Drive type made of stainless steel
- > Auto setting
- > Bidirectional
- > Non-slip rubber handgrip
- > EPA > see product



### TYPE S 757

- > Adjustable torque screwdriver with scale ring
- > Auto setting
- > Bidirectional
- > Anodised aluminium handgrip



### TYPE SP 758

- > Dial-indicating torque screwdriver with dual scale
- > Locking of maximum values / maximum value-display
- > Bidirectional
- > Anodised aluminium handgrip
- > EPA > see product



### SCOPE OF DELIVERY

- > We supply a 1/4"-1/4"-drive adaptor with all models
- > To make work easier, a sliding or removable T-bar is included with several models

### SPECIAL MODELS

- > Optionally, all torque screwdrivers are also available with a 1/4" male square drive spindle.
- > Apart from that: Torque screwdrivers for the medical "clean-room" area are available on request.

NEW

## PGNP FS

## TORQUE SCREWDRIVER TYPE PGNP FS

0.05 - 13.5 N·m / pre-set

## Use:

- > Controlled screw tightening in the range 0.05 - 13.5 N·m
- > Serial manufacture with constant tightening value
- > Electronic industry, precision mechanics and industrial manufacturing

## Features:

- > **Pre-set torque screwdriver without a scale**
- > With 1/4" female hexagon drive for use with 1/4" hexagon bits as per DIN 3126 - C 6.3
- > Classified to DIN EN ISO 6789:2003 Type II Class F, with a factory certificate allowing for operations to be traced back
- > Calibrated to a permitted +/- 6 % deviation of the set torque
- > Precision radial ball clutch and cam design for controlled bi-directional tightening
- > Precision mechanism slips very noticeably through when set torque is reached
- > Automatic resetting to the starting position
- > **Fatigue-free working due to an ergonomic hand grip and a smooth tool reset action**

- > **Calibration stickers can be easily applied to the purpose designed nose**
- > The pre-setting can be made at the factory or by the user on suitable torque testers
- > **If ordering, please specify the N·m value - if a fixed factory setting is desired (price on request)**

## Scope of delivery:

- > Torque screwdriver type PGNP FS
- > Models 4.5 and 13.5 with additional sliding T-bar for ease of use
- > Test certificate acc. to DIN EN ISO 6789
- > Delivered in sturdy cardboard packaging



Hex "	Hex	cN·m	N·m	l-mm	kg	Code	No.
1/4	6.3	5-25	0,05-0,25	132	0.210	2927756	PGNP 0.25 FS
1/4	6.3	20-150	0,2-1,5	132	0.210	2927764	PGNP 1.5 FS
1/4	6.3	50-450	0,5-4,5	140	0.230	2927772	PGNP 4.5 FS
1/4	6.3	250-1350	2,5-13,5	140	0.230	2927780	PGNP 13.5 FS

## PGNS FS

## TORQUE SCREWDRIVER TYPE PGNS FS

0.2 - 4.5 N·m / pre-set

## Use:

- > Controlled screw tightening in the range 0.2 - 4.5 N·m
- > Serial manufacture with constant tightening value
- > Precision mechanics and industrial manufacturing
- > Basic model

## Features:

- > **Pre-set torque screwdriver without a scale**
- > With 1/4" female hexagon drive for use with 1/4" hexagon bits as per DIN 3126 - C 6.3
- > Working accuracy: +/- 10 % tolerance of the set torque, **without calibration certificate**
- > Acc. to DIN EN ISO 6789, traceable to national standards

- > Precision mechanism slips very noticeably through when set torque is reached
- > For controlled directional tightening, anti-clockwise operation for loosening
- > The pre-setting can be made at the factory or by the user on suitable torque testers
- > **If ordering, please specify the N·m value - if a fixed factory setting is desired (price on request)**

## Scope of delivery:

- > Torque screwdriver type PGNS FS
- > Delivered in sturdy cardboard packaging

NEW



Hex "	Hex	cN·m	N·m	l-mm	kg	Code	No.
1/4	6.3	20-150	0,2-1,5	138	0.198	2927721	PGNS 1.5 FS
1/4	6.3	50-450	0,5-4,5	138	0.198	2927748	PGNS 4.5 FS

**NEW**

# PGNE FS

## TORQUE SCREWDRIVER TYPE PGNE FS

0.05 - 13.5 N·m / pre-set

**Use:**

- > Controlled screw tightening in the range 0.05 - 13.5 N-m
- > Serial manufacture with constant tightening value
- > Electronic industry, precision mechanics and industrial manufacturing

**Features:**

- > **Pre-set torque screwdriver without a scale**
- > With 1/4" female hexagon drive for use with 1/4" hexagon bits as per DIN 3126 - C 6.3
- > Classified to DIN EN ISO 6789:2003 Type II Class F, with a factory certificate allowing for operations to be traced back
- > Calibrated to a permitted +/- 6% deviation of the set torque
- > **EPA-conformant (Electrostatic Protected Area), for use in sensitive electrostatic applications**
- > Precision radial ball clutch and cam design for controlled bi-directional tightening
- > Precision mechanism slips very noticeably through when set torque is reached

- > Automatic resetting to the starting position
- > **Fatigue-free working due to an ergonomic hand grip and a smooth tool reset action**
- > **Calibration stickers can be easily applied to the purpose designed nose**
- > The pre-setting can be made at the factory or by the user on suitable torque testers
- > **If ordering, please specify the N-m value - if a fixed factory setting is desired (price on request)**

**Scope of delivery:**

- > Torque screwdriver type PGNE FS
- > Models 4.5 and 13.5 with additional sliding T-bar for ease of use
- > Test certificate acc. to DIN EN ISO 6789
- > Delivered in sturdy cardboard packaging



1/4"	⊘	cN·m	N·m	↳ mm ‹	⚖	Code	No.
1/4	6.3	5-25	0,05-0,25	132	0.210	2927799	PGNE 0.25 FS
1/4	6.3	20-150	0,2-1,5	132	0.210	2927802	PGNE 1.5 FS
1/4	6.3	50-450	0,5-4,5	140	0.230	2927810	PGNE 4.5 FS
1/4	6.3	250-1350	2,5-13,5	140	0.230	2927829	PGNE 13.5 FS

# 755

## TORQUE SCREWDRIVER TYPE FS

0.04-13.6 N·m / pre-set

**Use:**

- > Controlled screw tightening in the range 0.04 - 13.6 N-m
- > Serial manufacture with constant tightening value
- > Electronic industry, precision mechanics and industrial manufacturing

**Features:**

- > Pre-set torque screwdriver without a scale
- > With 1/4" female hexagon drive for use with 1/4" hexagon bits as per DIN 3126 - C 6.3
- > With adaptor also suitable for 1/4" square drive sockets as per DIN 3124
- > Working accuracy: +/- 6% tolerance of the set torque
- > Acc. to DIN EN ISO 6789, traceable to national standards
- > Precision radial ball clutch and cam design for controlled bi-directional tightening
- > Precision mechanism slips very noticeably through when the set torque is reached
- > Automatic resetting to the starting position

- > Lightweight construction by virtue of anodised aluminium handgrips
- > The pre-setting can be made at the factory or by the user on suitable torque testers
- > **If ordering, please specify the N-m value - if a fixed factory setting is desired (price on request)**

**Scope of delivery:**

- > Torque screwdriver type 755
- > 1/4" square/hexagon drive adaptor (no. 757-20)
- > Model 755-05 with additional removable T-bar for ease of use
- > Test certificate acc. to DIN EN ISO 6789
- > Delivered in sturdy cardboard packaging



755-05

1/4"	⊘	■"	■	cN·m	N·m	↳ mm ‹	⚖	Code	No.
1/4	6.3	1/4	6.3	4,4-22	0,04-0,22	76	0.050	1471481	755-01
1/4	6.3	1/4	6.3	4,4-22	0,04-0,22	104	0.072	1471473	755-02
1/4	6.3	1/4	6.3	27-135	0,27-1,35	111	0.210	1471465	755-03
1/4	6.3	1/4	6.3	80-400	0,8-4,0	127	0.280	1471457	755-04
1/4	6.3	1/4	6.3		2,8-13,6	137	0.325	1228501	755-05

# TORQUE SCREWDRIVERS 756

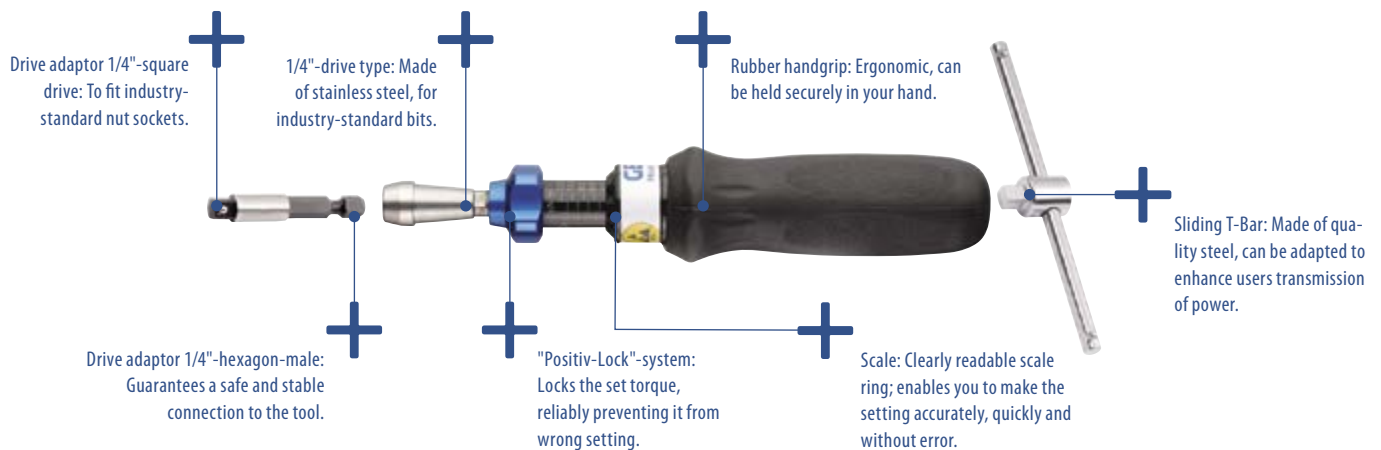

## 756 TORQUE SCREWDRIVER TYPE S

0.08-9 N·m

**Use:**

- > Controlled screw tightening in the range 0.08 - 9 N·m
- > High-speed, controlled tightening enables serial production
- > Electrical and electronic hardware industry, instrument-making industry and industrial manufacturing or in quality control

**Features:**

- > Adjustable torque screwdriver - with scale
- > With 1/4" female hexagon drive for use with 1/4" hexagon bits as per DIN 3126 - C 6.3
- > With adapter also suitable for 1/4" square drive sockets as per DIN 3124
- > Actuation accuracy: +/- 6% tolerance of the set value
- > Acc. to DIN EN ISO 6789, traceable to national standards
- > Precision radial ball clutch and cam design for controlled bi-directional tightening
- > Precision mechanism slips very noticeably through when the set torque is reached
- > Automatic resetting to the starting position
- > "Positive-Lock" system automatically fixes the set value preventing it from wrong setting.
- > 4 models in the range 0.05 N·m to 9 N·m

- > Micrometre scaling: 1 cN·m and 0.1 N·m
- > Very convenient, lightweight and non-slip rubber handgrip
- > EPA-conformant (Electrostatic Protected Area), for use in sensitive electrostatic applications

**Scope of delivery:**

- > Torque wrench type 756
- > 1/4" square/hexagon drive adapter (no. 757-20)
- > Models 756-06/-09 with additional sliding T-bar for ease of use
- > Test certificate acc. to DIN EN ISO 6789
- > Delivered in sturdy cardboard packaging



○"	○	■"	■	cN·m	N·m	l<mm>l	▬▬▬▬	⚖️/kg	Code	No.
1/4	6.3	1/4	6.3	8-40	0,08-0,4	159	1 cN·m	0.124	1498738	756-00
1/4	6.3	1/4	6.3	24-120	0,24-1,2	183	1 cN·m	0.165	1400150	756-01
1/4	6.3	1/4	6.3	120-600	1,2-6	196	0,1 N·m	0.340	1400169	756-06
1/4	6.3	1/4	6.3	400-900	4-9	196	0,1 Nm	0.340	1400177	756-09

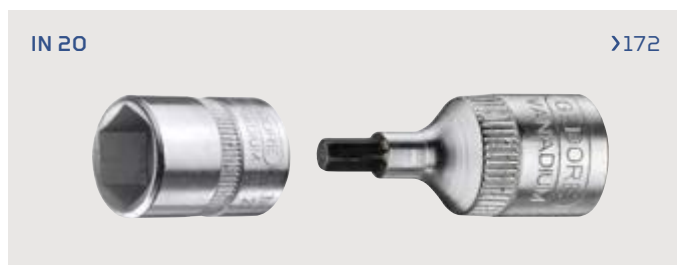



# 757 TORQUE SCREWDRIVER TYPE S

0.24-9 N·m

**Use:**

- > Controlled screw tightening in the range 24 cN·m - 9 N·m
- > High-speed, controlled tightening enables serial production
- > Electrical and electronic hardware industry, instrument-making industry and industrial manufacturing or in quality control

**Features:**

- > Adjustable torque screwdriver with scale
- > With 1/4" female hexagon drive for use with 1/4" hexagon bits as per DIN 3126 - C 6.3
- > With adaptor also suitable for 1/4" square drive sockets as per DIN 3124
- > Working accuracy: +/- 6 % tolerance of the set torque
- > Acc. to DIN EN ISO 6789, traceable to national standards
- > Precision radial ball clutch and cam design for controlled bi-directional tightening
- > Precision mechanism slips very noticeably through when set torque is reached
- > Automatic resetting to the starting position

- > Locking of the value by means of an adjusting knob
- > 3 models in the range 24 cN·m to 9 N·m
- > Micrometre scale graduation: 1 cN·m / 0.1 N·m
- > Lightweight construction by virtue of anodised aluminium handgrips

**Scope of delivery:**

- > Torque screwdriver type 757
- > 1/4" square/hexagon drive adaptor (no. 757-20)
- > Models 757-06/-09 with additional sliding T-bar for ease of use
- > Test certificate acc. to DIN EN ISO 6789
- > Delivered in sturdy cardboard packaging



757-09

Hexagon Drive	Hexagon Size	Hexagon Size	Hexagon Size	cN·m	N·m	Length	Scale	Weight	Code	No.
1/4"	6.3	1/4"	6.3	24-120	0,24-1,2	169	1,0 cN·m	0.165	7718050	757-01
1/4"	6.3	1/4"	6.3	120-600	1,2-6	184	0,1 N·m	0.400	7718130	757-06
1/4"	6.3	1/4"	6.3	400-900	4-9	184	0,1 N·m	0.400	7718210	757-09

# 758 TORQUE SCREWDRIVER TYPE SP

10-500 cN·m / 14 ozf·in - 40 lbf·in

**Use:**

- > In the torque range 0.1 - 5.0 N·m
- > For test and installation work in the electrical and electronic hardware industry, instrument-making industry and industrial manufacturing or in quality control

**Features:**

- > Dial-indicating torque and test screwdriver - with dual scale (cN·m/ozf·in/lbf·in)
- > With 1/4" female hexagon drive for use with 1/4" hexagon bits as per DIN 3126 - C 6.3
- > With adapter also suitable for 1/4" square drive sockets as per DIN 3124
- > Display accuracy: +/- 6 % tolerance of the indicated value
- > Acc. to DIN EN ISO 6789, traceable to national standards
- > For controlled bi-directional tightening
- > With slave-pointer function

- > For locking of maximum values / maximum-value display
- > 4 models in the range 0.1 N·m to 5.0 N·m
- > Lightweight construction by virtue of anodised aluminium handgrips
- > EPA-conformant (Electrostatic Protected Area), for use in sensitive electrostatic applications

**Scope of delivery:**

- > Torque screwdriver type 758
- > 1/4" square/hexagon drive adapter (no. 757-20)
- > Models 758-25/-50 with additional sliding T-bar for ease of use
- > Test certificate acc. to DIN EN ISO 6789
- > Delivered in sturdy cardboard packaging



Hexagon Drive	Hexagon Size	Hexagon Size	Hexagon Size	cN·m	N·m	ozf·in / lbf·in	Length	Scale	Weight	Code	No.
1/4"	6.3	1/4"	6.3	10-50	0,1-0,5	14-70 ozf·in	178	2 cN·m / 2 ozf·in	0.190	7096380	758-05
1/4"	6.3	1/4"	6.3	20-100	0,2-1	28-140 ozf·in	178	5 cN·m / 5 ozf·in	0.190	7096460	758-10
1/4"	6.3	1/4"	6.3	50-250	0,5-2,5	4-20 lbf·in	250	10 cN·m / 0,5 lbf·in	0.465	7096540	758-25
1/4"	6.3	1/4"	6.3	100-500	1,0-5,0	8-40 lbf·in	250	20 cN·m / 1 lbf·in	0.465	7096620	758-50

# TSN SLIPPER

Pre-set ratchet head torque wrench with automatic actuation and slip function. Over-tightening is not possible.



**Integrated ratchet function**  
Particularly dependable ratchet having 36 teeth (759-00/-01) or 48 teeth (759-02/-03). Slip-through function guarantees controlled and safe screw tightening, even in hard-to-access locations.

**High repeatability**  
Guarantees constant tightening torques.

**Rubber handgrip**  
Ergonomic and pleasant to hold in your hand. Prevents slipping.

**Robust casting part**  
Made of corrosion-resistant, rustproof material.

**Output square drive**  
Made of quality steel with ball-locking mechanism

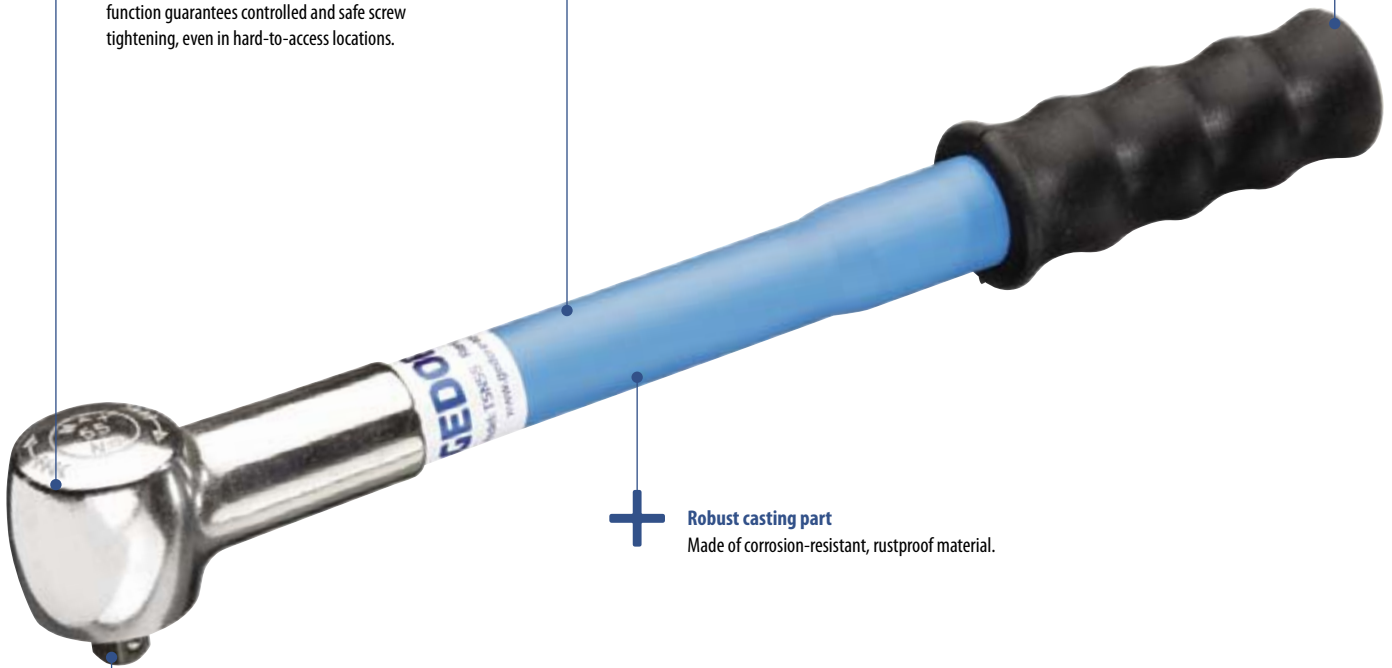

## Working principle

### TSN SLIPPER

When the pre-set torque value is achieved, the mechanism slips through over the ball (without the possibility of over-tightening). The torque wrench is then immediately ready for the next operation.

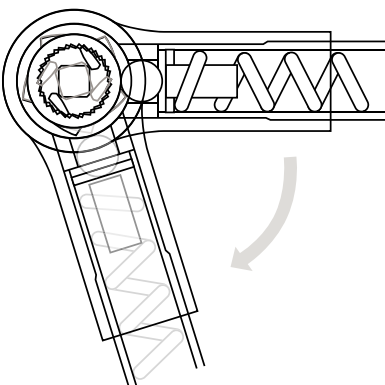

## Technical information

### TSN SLIPPER & TBN BREAKER

All TSN SLIPPER and TBN BREAKER torque wrenches (apart from 760-00/-01) are fitted with the patented "Mechanical Torque Adjustment Locking Device" to modify torque tester.

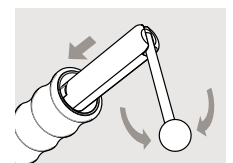
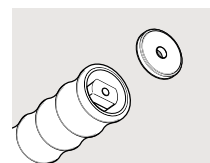
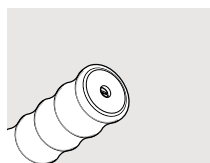

# 759 TORQUE WRENCH TSN SLIPPER

5-125 N·m / pre-set

## Use:

- > Controlled screw tightening in the range 5 - 125 N·m
- > Serial / production-line assembling
- > Extremely long-term work

## Features:

- > Pre-set production torque wrench - without scale
- > 1/4", 3/8" or 1/2" square drive with ball locking device
- > With integrated ratchet-function for controlled clockwise tightening
- > Working accuracy: +/- 4 % tolerance of the set torque
- > Acc. to DIN EN ISO 6789, traceable to national standards
- > Precision mechanism slips very noticeably and audibly ("click") when the pre-set value is achieved - over-tightening is not possible
- > Automatic resetting to the starting position
- > Lightweight yet robust and corrosion-resistant construction design

- > Very convenient non-slip rubber handgrip
- > The pre-setting can be made at the factory or by the user on suitable torque testers
- > If ordering, please specify the N·m value - if a factory pre-setting is desired (price on request)
- > EPA-conformant (Electrostatic Protected Area), for use in sensitive electrostatic applications

## Scope of delivery:

- > Torque wrench type TSN SLIPPER
- > Special adjusting key for changing the pre-set torque value
- > Test certificate acc. to DIN EN ISO 6789
- > Delivered in sturdy cardboard packaging



- > **TSN SLIPPER** - the pre-set production torque wrench (without scale).
- > With this torque wrench, accidental adjustment while working is ruled out.
- > The state-of-the-art lightweight production wrenches "slip" through as soon as the set torque is achieved.
- > Over-tightening is impossible.
- > The ideal torque tool for all jobs where for a longer time only one tightening torque value is required.
- > The automatic resetting and integrated ratchet are the ideal assistance for working swiftly.

- > TSNs for counter-clockwise tightening, bi-directional tightening without a ratchet-function or as a VDE-Wrench can be manufactured specially - on request.



"	■	N·m	l- mm -l	⚖	Code	No.
1/4	6.3	5-25	216	0.340	7091900	759-00
3/8	10.0	5-25	216	0.340	7092040	759-01
3/8	10.0	15-55	324	0.800	7092120	759-02
1/2	12.5	40-125	460	1.360	7092200	759-03

# 761 TORQUE WRENCH TSP SLIPPER

1-10 N·m / pre-set

- Use:**
- > Controlled screw tightening in the range 1 - 10 N·m
  - > Ideal for assembly work where controlled tightening with low torque values is required (e.g. electronic hardware sector, precision mechanics etc.)
- Features:**
- > Pre-set production torque wrench - without scale
  - > 1/4" square drive with ball locking device
  - > With integrated ratchet-function for controlled clockwise tightening
  - > Working accuracy: +/- 6 % tolerance of the set torque
  - > Acc. to DIN EN ISO 6789, traceable to national standards
  - > Precision mechanism slips very noticeably and audibly ("click") when the pre-set value is reached - over-tightening is not possible
  - > Automatic resetting to the starting position
  - > 2 models in the range 1 N-m to 10 N-m
- > Extremely lightweight yet robust and corrosion-resistant construction design
- > Very convenient non-slip rubber handgrip
- > EPA-conformant (Electrostatic Protected Area), for use in sensitive electrostatic applications
- > The pre-setting can be made at the factory or by the user on suitable torque testers
- > **If ordering, please specify the N·m value - if a fixed factory pre-setting is desired (price on request)**
- Scope of delivery:**
- > Torque wrench type TSP SLIPPER
  - > Adjusting tool for changing the pre-set torque value
  - > Test certificate acc. to DIN EN ISO 6789
  - > Delivered in sturdy cardboard packaging



- > **TSP SLIPPER** - the pre-set production torque wrench (without scale) for the lower torque range 1 - 10 N·m.
- > Accidental adjustment while working is ruled out.
- > The built-in ratchet with clockwise tightening and the corrosion-resistant lightweight construction design make this torque wrench the optimum working partner for quick and controlled screw tightening.
- > The integrated slipping mechanism reliably prevents over-tightening - the guarantee for high repeatability and controlled tightening values.



"	■	N·m	↳ mm ‹	⚖	Code	No.
1/4	6.3	1-5	185	0.190	1196650	761-05
1/4	6.3	2-10	185	0.190	1196731	761-10

# 762 TORQUE WRENCH TSC SLIPPER

1-10 N·m

- Use:**
- > Controlled screw tightening in the range 1 - 10 N·m
  - > Ideal for assembly work where controlled tightening with low torque values is required (e.g. electronic hardware sector, precision mechanics etc.)
- Features:**
- > Adjustable torque wrench - with scale
  - > 1/4" square drive with ball locking device
  - > With integrated ratchet-head function for controlled clockwise tightening
  - > Working accuracy: +/- 6 % tolerance of set torque
  - > Acc. to DIN EN ISO 6789, traceable to national standards
  - > Precision mechanism slips very noticeably and audibly ("click") when the set torque is reached - over-tightening is not possible
- > Automatic resetting to the starting position
- > Micrometre scale graduation: 0.05 N·m / 0.1 N·m
- > 2 models in the range 1 N-m to 10 N-m
- > Extremely lightweight yet robust and corrosion-resistant construction design
- > Very convenient non-slip rubber handgrip
- > EPA-conformant (Electrostatic Protected Area), for use in sensitive electrostatic applications
- Scope of delivery:**
- > Torque wrench type TSC SLIPPER
  - > Test certificate acc. to DIN EN ISO 6789
  - > Delivered in sturdy cardboard packaging
- > The scale is situated on the body tube.
- > The setting is made by rotating the unlocked handgrip with the integrated micrometre ring.
- > **TSC SLIPPER** - the adjustable torque wrenches (with scale) for the lower torque range 1 - 10 N·m.
- > The built-in ratchet with clockwise tightening and the corrosion-resistant lightweight construction design make this torque wrench the optimum working partner for quick and controlled screw tightening.
- > The integrated slipping mechanism reliably prevents over-tightening - the guarantee for high repeatability and controlled tightening values.



"	■	N·m	↳ mm ‹	⚖	⚖	Code	No.
1/4	6.3	1-5	195	0,05 N·m	0.235	1196480	762-05
1/4	6.3	2-10	195	0,1 N·m	0.235	1196510	762-10

# TBN BREAKER

Pre-set torque wrench with automatic snap actuation. Torque wrench offering maximum accuracy. Guaranteed tightening values without over-tightening.

**+** **Drive**  
16 mm spigot end or 9x12 mm rectangular cavity made of quality steel with pin-locking mechanism

**+** **Breaking**  
All TBN breaking torque wrenches break by 20° at the pivot point when the set torque is achieved. The models 760-00/-01 can also be set to a breaking angle of 90°.

**+** **Patented mechanism**  
Guarantees a long product lifespan with guaranteed accuracy values

**+** **Rubber handgrip:** Ergonomic and pleasant to hold in your hand. Prevents slipping.

**+** **Lightweight steel tube**  
Firm, solid, and free of corrosion



**TBN Knicker**  
15  
5 - 135 N-m



**TBN Knicker**  
9x12  
0,2 - 135 N-m



As an option, we also manufacture the TBN BREAKER models 760-00/-01 with interchangeable fittings directly positioned on the tool.

## Working principle

### TBN BREAKER

When the TBN breaking torque wrench is operated, the rear section of the driver unit presses the roller. When the pre-set torque value is achieved, the lever switches over and the front section of the drive unit breaks.

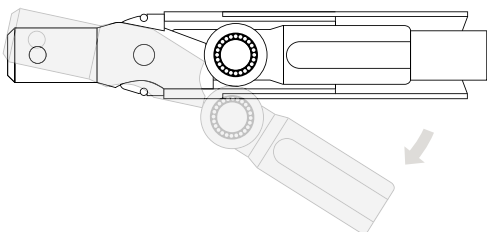

## Technical information

### TBN BREAKER

TBN BREAKER 760-00/-01 values are changed using the "Double Positive" adjustment system.



# 760 BREAKING TORQUE WRENCH TBN

0.4-135 N·m / 1.8-1195 lbf·in / pre-set

**Use:**

- > Controlled screw tightening in the range 0.4 - 135 N·m
- > Serial / production-line assembling
- > Extremely long-term work

**Features:**

- > Pre-set production torque wrench - without scale
- > With 9x12 mm rectangular-cavity-end or 16 mm spigot-end
- > For bi-directional tightening (the wrench only has to be turned by 180°!)
- > Working accuracy: +/- 4 % tolerance of the set torque
- > Acc. to DIN EN ISO 6789, traceable to national standards
- > Breaking of the handgrip by 20° (90° also possible in the case of no. 760-00/-01) when the pre-set torque value is achieved makes over-tightening unlikely
- > Automatic resetting to the starting position
- > Lightweight yet robust and corrosion-resistant construction design
- > Very convenient non-slip rubber handgrip

- > **No. 760-00/-01: EPA (Electrostatic Protected Area) compliant**
  - > The pre-setting can be made at the factory or by the user on suitable torque testers
  - > **If ordering, please specify the N-m value - if a fixed factory pre-setting is desired (price on request)**
- Scope of delivery:**
- > TBN breaking torque wrench
  - > Adjusting tool for changing the pre-set torque value
  - > Test certificate acc. to DIN EN ISO 6789
  - > Delivered in sturdy cardboard packaging



760-00



760-35



760-50



- > **TBN breaking torque wrench** - the pre-set production torque wrench (without scale).
- > With this torque wrench, accidental adjustment while working is ruled out.
- > The state-of-the-art lightweight production wrenches "break" as soon as the set torque is achieved.
- > Over-tightening is unlikely.
- > The ideal torque tool for all jobs where for a longer time only one tightening torque value is required.
- > For this reason, it is optimally suited for large series.
- > However, the TBN breaking torque wrench is also ideal when varying tightening values are required.

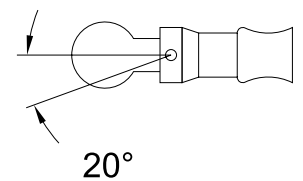

□ mm	∅	N·m	lbf·in	EPA	↳ mm ↲	⚖ kg	Code	No.
9 x 12		0,4-2,0	1,8-18	x	105	0.110	7090690	760-00
9 x 12		2-10	17,8-89	x	105	0.130	7090770	760-01
	16	5-25	44-221		265	0.405	1824686	760-30
9 x 12		5-25	44-221		265	0.405	1824694	760-35
	16	13-65	115-575		302	0.745	1824708	760-40
9 x 12		13-65	115-575		302	0.745	1824716	760-45
	16	27-135	239-1195		408	1.027	1824724	760-50
9 x 12		27-135	239-1195		408	0.830	7092630	760-11



## Torque wrench Type 88

# 8800 TORQUE WRENCH TYPE 88

100-1500 N·m / 70-1000 lbf·ft

**Use:**

- > Controlled screw tightening in the range 100 - 1500 N-m
- > Industry and vehicle sector (lorries, industrial vehicles), machine maintenance

**Features:**

- > Adjustable torque wrench - with scale
- > 3/4" square drive with integrated ratchet-function or 22 mm spigot-end
- > Suitable for bi-directional tightening on account of push-through square drive
- > Working accuracy: +/- 4% tolerance of the value setting
- > Acc. to DIN EN ISO 6789, traceable to national standards
- > Breaking mechanism as an actuation signal which can be seen and felt and makes over-tightening unlikely

- > Dual scale in N-m and lbf·ft
- > 5 models in the range 100 - 1500 N-m

**Scope of delivery:**

- > Type 88 breaking torque wrench
- > Operating instructions are provided on a label on the torque wrench
- > Test certificate acc. to DIN EN ISO 6789
- > Delivered in sturdy cardboard packaging

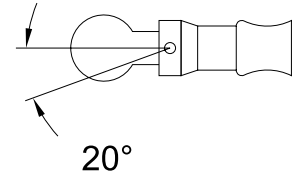

□"	■	∅	N·m	lbf·ft	↳ mm ‹	▬▬▬▬▬▬	⚖ kg	Code	No.
3/4	20		100-500	70-350	915	10 N·m	5.5	7715700	8800-01
3/4	20		150-700	100-500	1090	10 N·m	6.0	7715890	8800-02
3/4	20		300-1000	200-750	1470	20 N·m	7.3	7716000	8800-03
3/4	20		700-1500	500-1000	1470	25 N·m	10.5	7716190	8800-04
		22	130-550	100-400	915	10 N·m	4.8	7716270	8800-06

## Torque wrench Type 83

# TORQUE WRENCHES WITH SLAVE POINTER IDEAL FOR TEST, CONTROL AND MAINTENANCE WORK

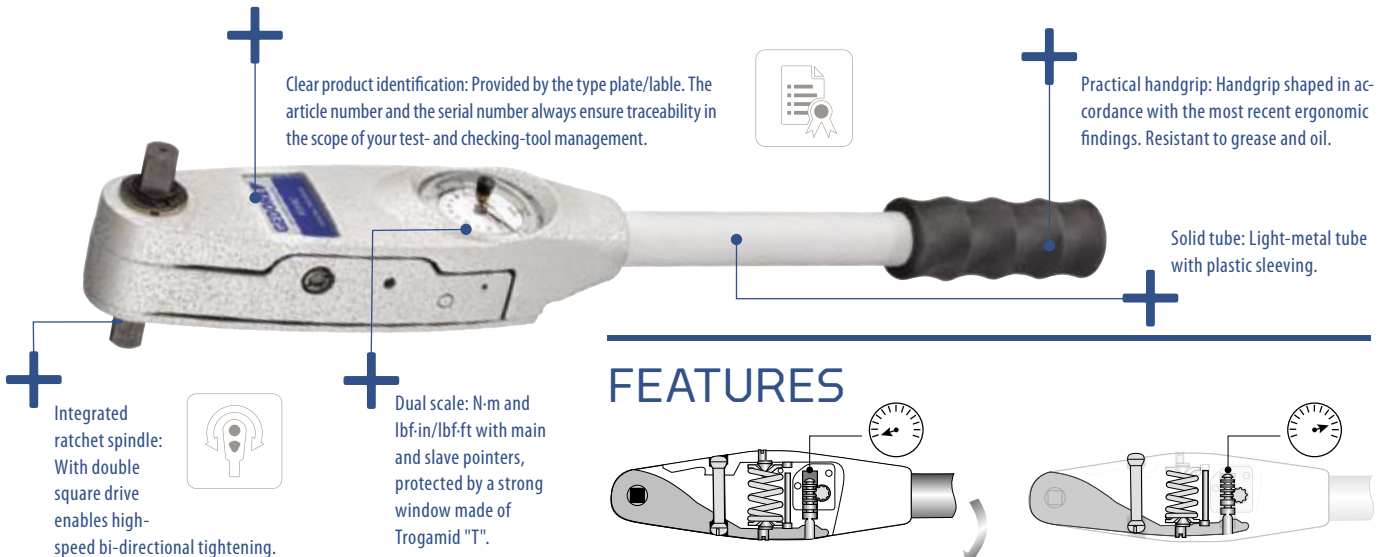

## FEATURES

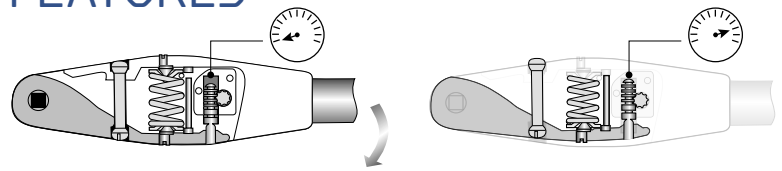

The working principle of the torque wrench with slave pointer type 83

## 8301 - 8305

# TORQUE WRENCH WITH SLAVE POINTER TYPE 83

0.8-2000 N·m / 7 lbf·in - 1500 lbf·ft

±4%  
○○○○○○○○



**Use:**

- > Controlled tightening and verification of tightening values
- > For use in all areas of industrial manufacturing and in quality control
- > Working ranges of 0.8 to 2000 N-m are covered

**Features:**

- > Dial-indicating torque wrench with dual scale and slave pointer
- > 1/4", 3/8", 1/2", 3/4" or 1" double-square drive with ball locking device for controlled bi-directional tightening
- > Models 8301-04 to 8304-80: With integrated ratchet-function
- > For controlled screw tightening and torque measurements
- > Working accuracy: +/- 4 % tolerance of the indicated torque
- > Acc. to DIN EN ISO 6789, traceable to national standards
- > With dual scale in N-m and lbf-in or lbf-ft double-tinted clearly readable face
- > Integrated overload protection - mechanical stop up to max. 25 % overload of the maximum value
- > Housing made of lightweight, robust special aluminium construction - lacquered, silver-grey
- > Black, non-slip rubber handgrips
- > **Models 8301-04 to 8301-40: EPA-conformant (Electrostatic Protected Area), for use in sensitive electrostatic applications**
- > Audio-visual signal is standard on models 8303-40 to 8305-20

**Scope of delivery:**

- > Dial-measuring torque wrench type 83
- > Battery (models 8303-40 to 8305-20)
- > Test certificate acc. to DIN EN ISO 6789
- > Delivered in a sturdy black plastic box (no. 8301-04 to 8302-20), otherwise in sturdy cardboard packaging (no. 8303-40 to 8305-20)



Type	█"	█	N-m	lbf-in	lbf-ft	EPA	↳ mm ↳		Height		Code	No.
	1/4	6,3	0,8-4	7-35		x	244	0,1 N-m / 1 lbf-in	61	0,5	7651390	8301-04
	1/4	6,3	2,4-12	22-120		x	244	0,5 N-m / 2 lbf-in	61	0,5	7651470	8301-12
	3/8	10,0	5-25	44-240		x	244	1 N-m / 10 lbf-in	69	0,5	7651550	8301-25
	3/8	10,0	8-40	72-360		x	244	1 N-m / 10 lbf-in	69	0,5	7651630	8301-40
	1/2	12,5	16-80		12-60		435	2 N-m / 1 lbf-ft	86	1,4	7651710	8302-08
	1/2	12,5	40-200		30-160		515	5 N-m / 5 lbf-ft	86	1,4	7651980	8302-20
	3/4	20,0	80-400		60-300		710	10 N-m / 10 lbf-ft	111	3,2	7652280	8303-40
	3/4	20,0	160-800		120-600		1000	20 N-m / 20 lbf-ft	123	4,8	7652010	8304-80
	1	25,0	280-1400		200-1000		2040	25 N-m / 25 lbf-ft	138	16,7	1196790	8305-14
	1	25,0	400-2000		300-1500		2040	50 N-m / 50 lbf-ft	138	16,7	1196804	8305-20

# ELECTRONIC TORQUE WRENCH E-TORC Q

**Powerful. Variable.**  
Holders: Rectangular-cavity SE 9x12 (E-torc Q 100) and SE 14x18 (E-torc Q 200, 300)

**Extensively. Resilient.**  
Large TFT graphics display of a 109 mm (4.3") diagonal with touch function. This makes a gloves operation possible.

**Ergonomic. Safe.**  
The ergonomic handle ensures easy, safe handling - even with large tightening torques.

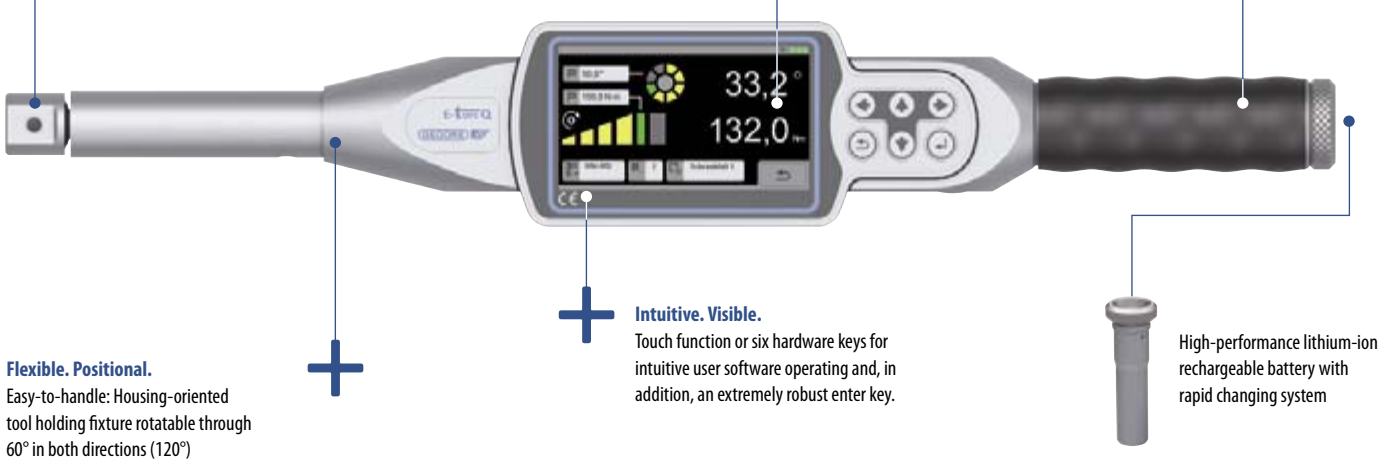

**Flexible. Positional.**  
Easy-to-handle: Housing-oriented tool holding fixture rotatable through 60° in both directions (120°)

**Intuitive. Visible.**  
Touch function or six hardware keys for intuitive user software operating and, in addition, an extremely robust enter key.

**High-performance lithium-ion rechargeable battery with rapid changing system**



**All the standard measurement methods:**

- > Torque
- > Torque/rotary angle
- > Loosening/tightening
- > First movement
- > Yield point
- > High measurement accuracy e.g. torque +/- 1%, +/- 1 digit



Communication to the high-capacity PC user software or attachment to CAQ systems (optional)



Charging unit for two lithium-ion rechargeable batteries (optional)

>

Virtual progress bar for torque and angle

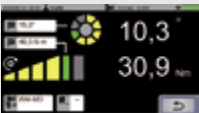

>

Measured value compilation and assessment



>

Touch screen for clear objective input



>

Clear depiction of the measurement results

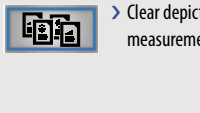

>

Graph representation and evaluation directly possible at E-torc Q

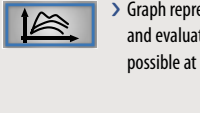

>

Operating with workflows

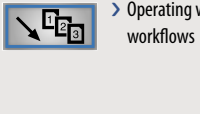

>

A variety of users and a user account management can be set up



>

Management of fitting and depth gauge parameters

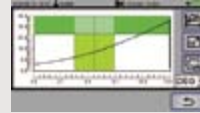

>

Wireless (Wi-Fi 2.4 and 5 GHz) or USB mini interface for communication purposes



>

Acoustic, visual or vibration-induced signalling



>

2D scanner (optional) for reading in barcodes and QR codes

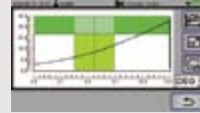

# Electronic Torque Wrenches

## ET2SA

### ELECTRONIC TORQUE WRENCH E-TORC

2-1000 N·m / 1.5-750 lbf·ft, with rotary angle measurement



**Tightening check for torque/rotary angle:**

- > Optical, acoustic and sensory signalling on reaching the set bolting parameter/with additional visualisation of screw tightening by means of LED progress bar.
- > Software-enabling graphics evaluation.
- > Marked contrast graphics display with backdrop lighting

**Drive:**

- > Spigot end 22/28 mm, 1/4" square drive or 9x12/14x18 mm rectangular cavity with pin-locking mechanism. The installation size determines the drive (model-dependent)
- > ET2SKA 150 and ET2SKA 300 incl. 1/2" rectangular reversible ratchet head
- > For hard-to-access places and given not enough room.
- > Special tools on request.

**Light and pleasant:**

- > The aluminium housing and ergonomic handle ensure easy, safe handling - even with large tightening torques.
- > Tool holding fixture, as from ET2SKA 150 120° rotatable to the aluminium housing

**Function keys:**

- > Easy to use
- > Key pressure taring
- > Side ergonomic operating key
- > Convertible from N-m to lbf-ft via software

**Fields of operation:**

- > Mini-batch assembly
- > Quality assurance
- > Test labs and testing departments
- > Emergency strategies for bolting stations
- > Corrective work places
- > Inspection and analysis of bolted connections

**Version:**

- > Large field of operation: 5 models in the range from 2 to 1000 N-m
- > Tool holding fixture 1/4" square, 9x12, 14x18 rectangular cavity with pin-locking mechanism, 22 and 28 mm spigot end
- > Signalling: visual (LED progress bar), acoustic (beep), sensory (vibration)
- > Tool holding fixture, as of ET2SKA 150 120° rotatable to the aluminium housing
- > Traceable to national standards
- > Torque reading precision +/- 1 %, +/- 1 digit from reading figure
- > Factory certificate as per DIN ISO 6789 Type I Class C
- > Optional certificate as per DAkkS-DKD-R 3-7
- > Rotary angle calibration based on VDI 2648 Sheet 2
- > Backlit graphic display
- > Input of depth gauges for a variety of attachment tools
- > Power supply: Battery or rechargeable battery operation

**Evaluation:**

- > Reading a max. 2,000 data records
- > Serial interface RS232 for PC (USB adapter enclosed)
- > Comprehensive documentation of all screw parameters

**Scope of delivery:**

- > Electronic torque wrench Etorc2S/A
- > Operating instructions with brief guide
- > Test certificate acc. to DIN EN ISO 6789:2003 Type I Class C
- > 2 standard Mignon AA batteries
- > Evaluating software and data transmission cable RS232 and USB
- > ET2SKA 150 and ET2SKA 300 incl. 1/2" rectangular reversible ratchet head
- > Delivered in a robust sheet-metal case with insert

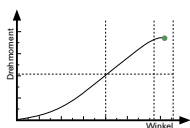

Torque/Angle



Editor



Parameter



Main screen



Settings

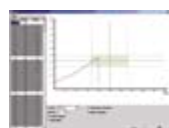

Curve diagram



■ "	■	□ mm	∅	N·m	lbf·ft	lw	a	b	c	d	kg	Code	No.
1/4	6.3			2-25	1,5-18	275	35	45		347	0.8	2795493	ET2SKA 25
1/2	12.5	9 x 12		10-150	7-111	457	35	45	17.5	514	1.3	2795612	ET2SKA 150
1/2	12.5	14 x 18		30-300	22-221	696	35	45	25.0	753	1.8	2795620	ET2SKA 300
			22	100-600	74-443	990	35	45	56.0	1055	3.2	2795639	ET2SKA 600
			28	100-1000	74-750	1423	40	45	75.0	1488	5.7	2795655	ET2SKA 1000

# TT3KH

## ELECTRONIC TORQUE WRENCH TORCOTRONIC III

10-350 N·m / 7.4-258.2 lbf·ft



### Use:

- > For everyday requirements in installation and torque control
- > For use in all areas of manufacturing and development

### Features:

- > Microprocessor-controlled, electronic torque wrench
- > For controlled bi-directional tightening
- > Acc. to DIN EN ISO 6789, traceable to national standards
- > Robust workshop design
- > Broad measurement range in N-m, can be switched to lbf·ft
- > With 1/2" reversible ratchet. The ratchet is exchangeable, providing the option of using a 9x12 mm (TT3H 120) or 14x18 mm (TT3H 350) square socket

### Characteristics:

- > Torque and torque angle measure
- > 4 different measuring modes
- > 5 parameters storable
- > USB interface for data exchange
- > 2000 storage places
- > Measurement accuracy torque +/- 1 %, +/- 1 digit
- > Measurement accuracy torque angle +/- 1 %, but min. +/- 1° on 360° with min. 4°/sec
- > Different depth gauges for end fittings programmable
- > Simple to operate with easy to understand icon-menu navigation and 4 functional keys
- > Clearly readable, illuminated LCD display
- > Resolution torque: 0.1 N-m
- > Resolution torque angle: 0.1°
- > PC-software easy to operate for uncomplicated programming and documentation of data
- > Data can be transferred to MS Excel®
- > Keyboard lock
- > Operation with standard Mignon AA or optional with rechargeable-battery (NiMH)
- > Visual signal: 3x LED (yellow, green, red)
- > Acoustic signal: buzzer
- > TÜV certified, CE and RoHS
- > 2 models in the range 10 - 350 N-m
- > Test certificate acc. to DIN EN ISO 6789:2003 Type I Class C
- > Calibration to DAkkS-DKD-R 3-7, Class 1 (on request)

### Scope of delivery:

- > Electronic torque wrench TorcoTronic III HighLine
- > Reversible ratchet 1/2"
- > USB cable
- > Software on CD-R
- > Test certificate acc. to DIN EN ISO 6789:2003 Type I Class C
- > Delivered in a transparent plastic box with insert

### Attention:

- > A PC, running a Windows® operating system (from Windows XP®) is required to obtain the full benefit of all the functions of this product.



Main menu



Settings



Parameter



Evaluation

"	mm	N·m	lbf·ft	kg	Code	No.
1/2	9 x 12	10-120	7,4-88,5	0.9	2648636	TT3KH 120
1/2	14 x 18	70-350	51,6-258,2	1.2	2648644	TT3KH 350

## Torque calibration analysers

## 8612

## ELECTRONIC TORQUE TESTER DREMOTEST E

0.2-3150 N·m / 1.8 lbf·in - 2323 lbf·ft

- > For verifying and setting clockwise torque wrenches and torque screwdrivers
- > Easy to operate, electronic torque tester with integrated torque transducer (DMS)
- > 5 models in the range from 0.2 to 3150 N·m
- > With fixed hexagon female drive 1/4", 10, 17, 36, 46 mm or 1.1/2" square drive adaptor (model dependent)
- > With 1/4", 3/8", 1/2", 3/4", 1" square drive adaptor or bit adaptor (model dependent)
- > High measurement accuracy: +/- 1% tolerance of reading, +/- 1 digit
- > Break-Point-measurement (1st peak)
- > Autoreset
- > Can be switched from N·m to lbf·ft
- > Serial interface RS232
- > Optionally available: adaptor for cigarette lighter socket (12 V), no. 8612-390

**Scope of delivery:**

- > Electronic torque tester
- > RS232 cable
- > Power supply unit with EURO plug (UK, US, AUS-adaptor on request)
- > 100 - 240 V, 50 - 60 Hz, max. 500 mA (see type plate)
- > 2 sockets (size and drive model-dependent)
- > Adaptor for 8612-3150
- > Operating instructions
- > Packaging



8612-300



8612-3150

N·m	lbf·in	lbf·ft	□	Resolution	Adaptor □	⚖	Code	No.
<b>0,2-12</b>	1,8-106		6.3	0,001	1/4", 3/8"	3.0	2288311	8612-012
<b>0,9-55</b>		0,7-40,6	10.0	0,01	1/4", 3/8"	3.0	1947699	8612-050
<b>9-320</b>		7-236	17.0	0,1	3/8", 1/2"	3.0	1856111	8612-300
<b>90-1100</b>		66-811	36.0	1	1/2", 3/4"	10.0	1947702	8612-1000
<b>500-3150</b>		369-2323		1	1"	26.0	2529858	8612-3150

**OPTIONAL ACCESSORIES:**

Description	⚖	Code	No.
<b>Adaptor for cigarette lighter socket</b>	0.150	1878719	8612-390



## Torsion test device E-tp

# ETP

## ELECTRONIC TORSION TEST DEVICE

- > For testing, and verifying clockwise and anti-clockwise torque wrenches
- > 5 models in the range of 0.5 to 3150 N-m
- > Vertical and horizontal testing according to DIN EN ISO 6789
- > Electronic torque tester integrated with measurement electronics
- > Robust housing from aluminium cast with separate or detachable operating display
- > Serial interface RS232 for PC
- > Traceable to national standards
- > ETP 15 with integrated overload protection and tool for manual resetting after unintended overload
- > Torque reading precision +/- 1 %, +/- 1 digit from reading figure
- > Factory certificate based on VDI 2646
- > Optional certificate as per DAkkS-DKD-R 3-8
- > A large LC graphic display
- > Wide measuring range in N-m, can be switched to cN-m, lbf-ft or lbf-in (model dependant)
- > Power supply unit with EURO plug (UK, US, AUS-adaptor on request)
- > Accessories: Operating display, display holder incl. cable, software incl. connection cable for PC



□"	□	N-m	lbf-ft	Resolution	Adaptor	⚖️	Code	No.
1/4	6.3	0,5-15	0,4-11	0,001 N-m	-	4.8	2795663	ETP 15
1/2	12.5	4-100	3-74	0,01 N-m	1/4", 3/8"	10.0	2795701	ETP 100
3/4	20.0	20-500	14,8-369	0,1 N-m	3/8", 1/2"	10.3	2795728	ETP 500
3/4	20.0	50-1000	36,9-737,6	0,1 N-m	3/8", 1/2"	10.3	2795868	ETP 1000
1.1/2	40.0	300-3150	221-2323	1,0 N-m	3/4", 1"	26.8	2795884	ETP 3150

# ETPG

## BASIC HOUSING

- > From aluminium cast (except ETP3150)
- > Serial interface RS232 for PC
- > Traceable to national standards with factory certificate
- > High measurement accuracy: +/- 1 % tolerance of reading, +/- 1 digit
- > ETPG 15 with integrated overload protection and tool for manual resetting after unintended overload
- > Wide measuring range in N-m, can be switched to cN-m, lbf-ft or lbf-in
- > Power supply unit with EURO plug (UK, US, AUS-adaptor on request)



□"	□	N-m	lbf-ft	Resolution	Adaptor	⚖️	Code	No.
1/4	6.3	0,5-15	0,4-11	0,001 N-m	-	4.0	2795892	ETPG 15
1/2	12.5	4-100	3-74	0,01 N-m	1/4", 3/8"	9.2	2795906	ETPG 100
3/4	20.0	20-500	14,8-369	0,1 N-m	3/8", 1/2"	9.5	2795914	ETPG 500
3/4	20.0	50-1000	36,9-737,6	0,1 N-m	3/8", 1/2"	9.5	2795930	ETPG 1000
1.1/2	40.0	300-3150	221-2323	1,0 N-m	3/4", 1"	26.0	2795957	ETPG 3150

# Torque angle indicator

## TORQUE ANGLE INDICATOR 8200



- > When using torque angle indicator no. 8200, please note: The maximum output of the torque wrenches must not be passed. Please ensure that the maximum load capacity of the square drive including the values achieved by angle-regulated tightening is not exceeded:
- > 1/2" max. approx. 390 N-m
- > 3/4" max. approx. 1330 N-m

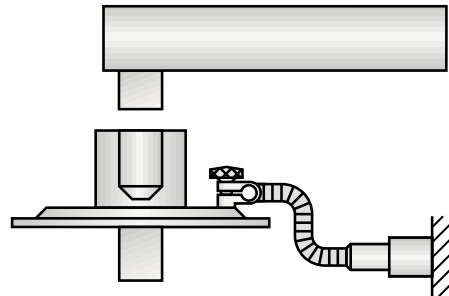

## 8200 TORQUE ANGLE INDICATOR

**Use:**

- > Additional angle-regulated tightening for controlled torque and angle activation

**Features:**

- > Torque angle indicator with 1/2" or 3/4" square drive
- > For additional precise angle tightening (0 - 360°)
- > 1/2" square drive with ball locking device or 3/4" square drive with pin locking device
- > No. 8200-01/-02 models with sliding magnetic and gripping arm
- > No. 8200-11 only with magnetic arm - simple design
- > To operate with a suitable torque wrench
- > The maximum output of the torque wrench must not be passed

**Scope of delivery:**

- > Torque angle indicator
- > Delivered in a strong plastic case (no. 8200-01/-02), model no. 8200-11 in sturdy hard cardboard packaging



8200-01



8200-02

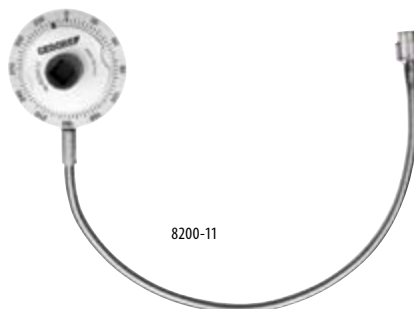

8200-11

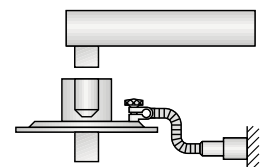

■ "	□ "	∅ mm	∠ °	⚖ kg	Code	No.
1/2	1/2	80	0-360	0.330	1195980	8200-01
1/2	1/2	82	0-360	0.330	7718480	8200-11
3/4	3/4	120	0-360	0.530	7716510	8200-02

## Accessories

## End fittings 16 Z

8791 (MM)  
OPEN END FITTING

## 16 Z

- > For accessing bolts in cramped and hard-to-reach locations, easy to change
- > Forged
- > Chrome-vanadium steel, matt chrome-plated
- > With eject-pin for unlocking



Ø mm	Ø	mm	Ø mm	Depth gauge		Code	No.
7	16	5	20.5	32	0.080	7774470	8791-07
8	16	5	20.5	32	0.080	7774550	8791-08
9	16	5	20.5	32	0.080	7774630	8791-09
10	16	7	29.0	32	0.090	7710070	8791-10
11	16	7	29.0	32	0.090	7710150	8791-11
12	16	7	29.0	32	0.090	7676890	8791-12
13	16	8	34.5	32	0.120	7710230	8791-13
14	16	8	34.5	32	0.120	7710310	8791-14
15	16	8	34.5	32	0.120	7710580	8791-15
16	16	9	41.5	32	0.160	7710660	8791-16
17	16	9	41.5	32	0.160	7710740	8791-17
18	16	9	41.5	32	0.160	7676970	8791-18
19	16	10	45.0	32	0.180	7710820	8791-19

Ø mm	Ø	mm	Ø mm	Depth gauge		Code	No.
20	16	10	45.0	32	0.180	7710900	8791-20
21	16	10	45.0	32	0.180	7677000	8791-21
22	16	11	56.0	32	0.220	7711040	8791-22
23	16	11	56.0	32	0.220	1977164	8791-23
24	16	11	56.0	32	0.220	7711120	8791-24
25	16	11	56.0	32	0.220	1552279	8791-25
26	16	11	56.0	32	0.220	1552287	8791-26
27	16	12	60.5	32	0.260	7711200	8791-27
28	16	12	68.0	32	0.300	1207008	8791-28
29	16	12	68.0	32	0.300	1552309	8791-29
30	16	12	68.0	32	0.300	7774710	8791-30
32	16	12	68.0	32	0.300	7774980	8791-32
36	16	12	68.0	32	0.300	1552317	8791-36

8791 (AF)  
OPEN END FITTING

## 16 Z

- > For accessing bolts in cramped and hard-to-reach locations, easy to change
- > Forged
- > Chrome-vanadium steel, matt chrome-plated
- > With eject-pin for unlocking



Ø AF	Ø	mm	Ø mm	Depth gauge		Code	No.
1/4	16	5	20.5	32	0.090	1211421	8791-1/4AF
5/16	16	5	20.5	32	0.080	7720030	8791-5/16AF
3/8	16	7	29.0	32	0.090	1211447	8791-3/8AF
7/16	16	7	29.0	32	0.090	7720110	8791-7/16AF
1/2	16	8	34.5	32	0.090	7720380	8791-1/2AF
9/16	16	8	34.5	32	0.120	7720460	8791-9/16AF
5/8	16	9	41.5	32	0.160	7720540	8791-5/8AF
11/16	16	9	41.5	32	0.160	7720620	8791-11/16AF
3/4	16	10	45.0	32	0.180	7720700	8791-3/4AF
13/16	16	10	45.0	32	0.090	1211439	8791-13/16AF
7/8	16	11	56.0	32	0.220	7720890	8791-7/8AF
15/16	16	11	56.0	32	0.220	7720970	8791-15/16AF

Ø AF	Ø	mm	Ø mm	Depth gauge		Code	No.
1	16	11	56.0	32	0.220	7721000	8791-1AF
1.1/16	16	12	60.5	32	0.260	7721190	8791-1.1/16AF
1.1/8	16	12	68.0	32	0.300	7721270	8791-1.1/8AF
1.3/16	16	12	68.0	32	0.300	7776170	8791-1.3/16AF
1.1/4	16	12	68.0	32	0.300	7776250	8791-1.1/4AF
1.5/16	16	12	68.0	32	0.300	7776330	8791-1.5/16AF

# 8792 (MM)

## RING END FITTING

16 Z

- > For accessing bolts in cramped and hard-to-reach locations, easy to change
- > Forged
- > Chrome-vanadium steel, matt chrome-plated
- > With eject-pin for unlocking



Ø mm	Ø	mm <sub>2</sub>	Ø mm	Depth gauge	kg	Code	No.
7	16	8	15.0	32	0.090	7775010	8792-07
8	16	8	15.0	32	0.090	7775280	8792-08
9	16	8	15.0	32	0.090	7775360	8792-09
10	16	10	19.5	32	0.100	7712600	8792-10
11	16	10	19.5	32	0.100	7712790	8792-11
12	16	10	19.5	32	0.100	7677190	8792-12
13	16	12	23.5	32	0.140	7712870	8792-13
14	16	12	23.5	32	0.140	7712950	8792-14
15	16	12	23.5	32	0.140	7713090	8792-15
16	16	13	28.5	32	0.180	7713170	8792-16

Ø mm	Ø	mm <sub>2</sub>	Ø mm	Depth gauge	kg	Code	No.
17	16	13	28.5	32	0.180	7713250	8792-17
18	16	13	28.5	32	0.180	7677270	8792-18
19	16	14	31.5	32	0.210	7713330	8792-19
20	16	14	31.5	32	0.210	7713410	8792-20
21	16	14	31.5	32	0.210	7677350	8792-21
22	16	15	39.5	32	0.260	7713680	8792-22
23	16	15	39.5	32	0.270	1211471	8792-23
24	16	15	39.5	32	0.260	7713760	8792-24
27	16	16	41.5	32	0.300	7713840	8792-27

# 8792 (AF)

## RING END FITTING

16 Z

- > For accessing bolts in cramped and hard-to-reach locations, easy to change
- > Forged
- > Chrome-vanadium steel, matt chrome-plated
- > With eject-pin for unlocking



Ø AF	Ø	mm <sub>2</sub>	Ø mm	Depth gauge	kg	Code	No.
1/4	16	8	15.0	32	0.100	1211455	8792-1/4AF
5/16	16	8	15.0	32	0.090	7721350	8792-5/16AF
3/8	16	10	19.5	32	0.100	1211498	8792-3/8AF
7/16	16	10	19.5	32	0.100	7721430	8792-7/16AF
1/2	16	12	23.5	32	0.100	7721510	8792-1/2AF
9/16	16	12	23.5	32	0.140	7721780	8792-9/16AF
5/8	16	13	28.5	32	0.140	7721860	8792-5/8AF

Ø AF	Ø	mm <sub>2</sub>	Ø mm	Depth gauge	kg	Code	No.
11/16	16	13	28.5	32	0.180	7721940	8792-11/16AF
3/4	16	14	31.5	32	0.210	7722080	8792-3/4AF
13/16	16	14	31.5	32	0.100	1211463	8792-13/16AF
7/8	16	15	39.5	32	0.260	7722160	8792-7/8AF
15/16	16	15	39.5	32	0.260	7722240	8792-15/16AF
1	16	15	39.5	32	0.300	7722320	8792-1AF
1.1/16	16	16	41.5	32	0.300	7722400	8792-1.1/16AF

# 8797

## FLARED END FITTING

16 Z

- > For accessing bolts in cramped and hard-to-reach locations, easy to change
- > Forged
- > Chrome-vanadium steel, matt chrome-plated
- > With eject-pin for unlocking



Ø mm	Ø	mm <sub>2</sub>	Ø mm	max. N·m	c <sub>1</sub>	Depth gauge	kg	Code	No.
7	16	8	15.0	7.0	5.5	32	0.090	1211587	8797-07
8	16	8	15.0	6.5	6.0	32	0.090	1211595	8797-08
9	16	8	15.0	5.5	6.5	32	0.090	1211609	8797-09
10	16	10	19.5	26.0	7.0	32	0.100	1211625	8797-10
11	16	10	19.5	19.0	8.5	32	0.100	1211633	8797-11
12	16	10	19.5	13.0	9.0	32	0.120	1211641	8797-12
13	16	12	23.5	34.0	10.0	32	0.140	1211668	8797-13
14	16	12	23.5	24.0	11.2	32	0.140	7664290	8797-14
15	16	12	23.5	18.0	12.0	32	0.140	1211684	8797-15

Ø mm	Ø	mm <sub>2</sub>	Ø mm	max. N·m	c <sub>1</sub>	Depth gauge	kg	Code	No.
16	16	13	28.5	66.0	13.0	32	0.180	1211692	8797-16
17	16	13	28.5	56.0	14.0	32	0.180	1211706	8797-17
18	16	13	28.5	45.0	14.5	32	0.200	1211714	8797-18
19	16	14	31.5	80.0	15.0	32	0.210	1211722	8797-19
20	16	14	31.5	60.0	16.0	32	0.210	1211731	8797-20
21	16	14	31.5	43.0	16.5	32	0.210	1211749	8797-21
22	16	15	39.5	172.0	17.0	32	0.260	1211757	8797-22
24	16	15	39.5	118.0	18.0	32	0.260	1211773	8797-24
27	16	16	41.5	76.0	20.0	32	0.300	1211781	8797-27

## 8754 RATCHET HEAD

16 Z

- > For accessing bolts in cramped and hard-to-reach locations, easy to change
- > Forged
- > Chrome-vanadium steel, matt chrome-plated

- > With eject pin for unlocking
- > Max. continuous load of ratchet according to DIN EN ISO 6789:2003 and/or maximum load of cavity



8754-01



8754-02



■"	■	∅	Type	Depth gauge	Continuous load	⚖	Code	No.
3/8	10.0	16	●	32	3/8" = 135 N-m	0.170	7711980	8754-01
1/2	12.5	16	●	32	1/2" = 340 N-m	0.270	7712010	8754-02

## 8756 END FITTING IN-HEX

16 Z

- > For accessing bolts in cramped and hard-to-reach locations, easy to change
- > Forged
- > Chrome-vanadium steel, matt chrome-plated
- > With eject-pin for unlocking

## 8790 - 8793 FIXED SQUARE HEAD

16 Z

- > For accessing bolts in cramped and hard-to-reach locations, easy to change
- > Forged
- > Chrome-vanadium steel, matt chrome-plated
- > With eject pin for unlocking
- > Max. continuous load of ratchet according to DIN EN ISO 6789:2003 and/or maximum load of cavity



● mm	∅	Depth gauge	⚖	Code	No.
3	16	32	0.100	7773740	8756-03
4	16	32	0.100	7773820	8756-04
5	16	32	0.100	7773900	8756-05
6	16	32	0.100	7774040	8756-06
8	16	36	0.110	7774120	8756-08

■"	■	∅	Type	Depth gauge	Continuous load	⚖	Code	No.
3/8	10.0	16	■	32	3/8" = 135 N-m	0.350	7709490	8790-00
1/2	12.5	16	■	32	1/2" = 340 N-m	0.380	7709570	8793-00

## End fittings 22 Z

## 8794-00

### FIXED SQUARE HEAD

22 Z

- › For accessing bolts in cramped and hard-to-reach locations, easy to change
- › Forged
- › Chrome-vanadium steel, matt chrome-plated



■"	■	∅	Type	Depth gauge	Continuous load		Code	No.
3/4	20	22		56	3/4" = 850 N·m	0.610	7708840	8794-00

## 8795

### OPEN END FITTING

22 Z

- › For accessing bolts in cramped and hard-to-reach locations, easy to change
- › Forged
- › Chrome-vanadium steel, matt chrome-plated
- › With eject-pin for unlocking

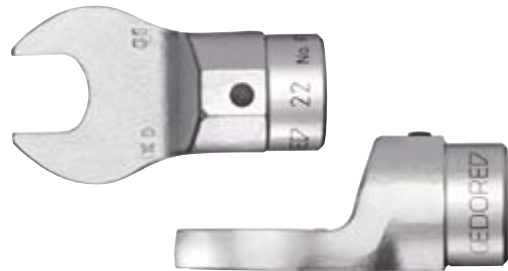

∅ mm	∅	mm	∅ mm	Depth gauge		Code	No.
22	22	11	52.0	56	0.330	7707010	8795-22
24	22	11	52.0	56	0.320	7707280	8795-24
27	22	12	64.0	56	0.380	7707360	8795-27
30	22	12	64.0	56	0.370	7707440	8795-30
32	22	12	75.5	56	0.450	7707520	8795-32

∅ mm	∅	mm	∅ mm	Depth gauge		Code	No.
34	22	12	75.5	56	0.430	7677430	8795-34
36	22	12	75.5	56	0.430	7707600	8795-36
41	22	12	94.0	56	0.580	7707790	8795-41
46	22	12	94.0	56	0.530	7707870	8795-46

## 8796

### RING END FITTING

22 Z

- › For accessing bolts in cramped and hard-to-reach locations, easy to change
- › Forged
- › Chrome-vanadium steel, matt chrome-plated
- › With eject-pin for unlocking



∅ mm	∅	mm	∅ mm	Depth gauge		Code	No.
22	22	15	38.0	56	0.350	7707950	8796-22
24	22	15	38.0	56	0.330	7708090	8796-24
27	22	17	46.5	56	0.370	7708170	8796-27
30	22	17	46.5	56	0.350	7708250	8796-30
32	22	20	54.0	56	0.420	7708330	8796-32

∅ mm	∅	mm	∅ mm	Depth gauge		Code	No.
34	22	20	54.0	56	0.420	7677510	8796-34
36	22	20	54.0	56	0.390	7708410	8796-36
41	22	22	68.0	56	0.560	7708680	8796-41
46	22	22	68.0	56	0.520	7708760	8796-46



# 8794-02 - 8794-03

## RATCHET HEAD

22 Z

- > For accessing bolts in cramped and hard-to-reach locations, easy to change
- > Forged
- > Chrome-vanadium steel, matt chrome-plated
- > With eject-pin for unlocking

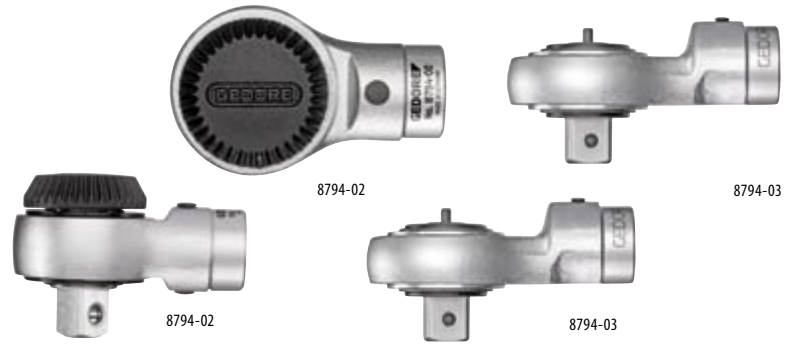

■"	■	∅	Type	Depth gauge	Continuous load	⚖	Code	No.
3/4	20	22	●□	56	3/4" = 850 N-m	1.011	2961385	8794-02
3/4	20	22	●□	56	3/4" = 850 N-m	0.950	1427318	8794-03

## End fittings 28 Z

# 8798

## OPEN END FITTING

28 Z

- > For accessing bolts in cramped and hard-to-reach locations, easy to change
- > Chrome-vanadium steel, matt chrome-plated
- > With catch retention
- > Special sizes available on request



∅ mm	∅	mm <sup>2</sup> ⇄	∅ mm	Depth gauge	⚖	Code	No.
36	28	18.0	77.5	75	1.9	1565346	8798-36
41	28	19.5	89.0	75	1.9	1565354	8798-41
46	28	20.0	99.0	75	1.9	1565362	8798-46
50	28	21.5	108.0	75	1.9	1565370	8798-50
55	28	24.5	118.5	75	2.1	1565389	8798-55
60	28	24.5	129.5	75	2.1	1565397	8798-60
65	28	28.0	140.5	75	2.4	1565400	8798-65
70	28	30.0	151.0	75	2.9	1565419	8798-70
75	28	31.5	163.0	100	4.0	1565427	8798-75

# 8799

## RING END FITTING

28 Z

- > For accessing bolts in cramped and hard-to-reach locations, easy to change
- > Chrome-vanadium steel, matt chrome-plated
- > With catch retention
- > Special sizes available on request



∅ mm	∅	mm <sup>2</sup> ⇄	∅ mm	Depth gauge	⚖	Code	No.
36	28	19.5	60	75	1.6	1565494	8799-36
41	28	20.5	66	75	1.8	1565508	8799-41
46	28	22.5	75	75	2.1	1565516	8799-46
50	28	23.5	80	75	2.2	1565524	8799-50
55	28	25.0	88	75	2.4	1565532	8799-55
60	28	26.0	94	75	2.5	1565540	8799-60
65	28	29.0	101	75	2.9	1565559	8799-65
70	28	32.5	110	75	2.0	1565567	8799-70
75	28	34.0	117	100	4.5	1565575	8799-75
80	28	35.0	123	100	4.8	1565583	8799-80

# 8794

## RATCHET HEAD

28 Z

- > For accessing bolts in cramped and hard-to-reach locations, easy to change
- > Chrome-vanadium steel, matt chrome-plated
- > With catch retention
- > Max. continuous load of coupler according to DIN EN ISO 6789:2003 and/or maximum support load: 1000 N-m



■"	■	∅	Type	Depth gauge	⚖	Code	No.
3/4	20	28	●□	75	1.8	1566032	8794-05

## End fittings 9x12 SE

## 7112

### RECTANGULAR OPEN END FITTING

9x12

- › For accessing bolts in cramped and hard-to-reach locations, easy to change
- › Forged
- › Chrome-vanadium steel, matt chrome-plated
- › With eject-pin for unlocking



Ø mm	□ mm	mm <sup>2</sup> ⇄	Ø mm	Depth gauge	⇄ kg	Code	No.
7	9 x 12	5.5	20.0	17.5	0.035	7688390	7112-07
8	9 x 12	5.5	21.5	17.5	0.035	7688550	7112-08
9	9 x 12	5.5	23.0	17.5	0.035	7679050	7112-09
10	9 x 12	5.5	24.5	17.5	0.040	7688630	7112-10
11	9 x 12	5.5	26.0	17.5	0.030	7688980	7112-11
12	9 x 12	5.5	27.5	17.5	0.035	7679560	7112-12
13	9 x 12	5.5	29.0	17.5	0.035	7689010	7112-13
14	9 x 12	7.5	31.0	20.0	0.040	7689360	7112-14

Ø mm	□ mm	mm <sup>2</sup> ⇄	Ø mm	Depth gauge	⇄ kg	Code	No.
15	9 x 12	7.5	33.0	20.0	0.040	7689440	7112-15
16	9 x 12	7.5	35.0	20.0	0.045	7679990	7112-16
17	9 x 12	7.5	37.0	20.0	0.050	7689600	7112-17
18	9 x 12	7.5	39.0	20.0	0.060	7684560	7112-18
19	9 x 12	7.5	41.0	20.0	0.060	7689790	7112-19

## 7212

### RECTANGULAR RING END FITTING

9x12

- › For accessing bolts in cramped and hard-to-reach locations, easy to change
- › Forged
- › Chrome-vanadium steel, matt chrome-plated
- › With eject-pin for unlocking



Ø mm	□ mm	mm <sup>2</sup> ⇄	Ø mm	Depth gauge	⇄ kg	Code	No.
7	9 x 12	8	13.0	17.5	0.030	7691340	7212-07
8	9 x 12	8	14.2	17.5	0.030	7691420	7212-08
10	9 x 12	8	17.2	17.5	0.030	7691690	7212-10
11	9 x 12	8	18.6	17.5	0.030	7691770	7212-11
12	9 x 12	12	20.0	17.5	0.035	7677940	7212-12
13	9 x 12	12	21.5	17.5	0.035	7691930	7212-13
14	9 x 12	12	23.0	17.5	0.040	7692230	7212-14

Ø mm	□ mm	mm <sup>2</sup> ⇄	Ø mm	Depth gauge	⇄ kg	Code	No.
15	9 x 12	12	24.0	17.5	0.040	7692580	7212-15
16	9 x 12	13	26.0	17.5	0.040	7678080	7212-16
17	9 x 12	13	27.0	17.5	0.040	7692740	7212-17
18	9 x 12	13	28.5	17.5	0.040	7678160	7212-18
19	9 x 12	13	30.5	17.5	0.040	7692820	7212-19
21	9 x 12	15	33.0	17.5	0.050	7678240	7212-21
22	9 x 12	15	34.5	17.5	0.050	7693040	7212-22

## 7312

### RECTANGULAR FLARED END FITTING

9x12

- › For accessing bolts in cramped and hard-to-reach locations, easy to change
- › Forged
- › Chrome-vanadium steel, matt chrome-plated
- › With eject-pin for unlocking



Ø mm	□ mm	mm <sup>2</sup> ⇄	Ø mm	Opening width	Depth gauge	⇄ kg	Code	No.
10	9 x 12	12	21.0	7.3	17.5	0.040	7685290	7312-10
11	9 x 12	12	22.5	8.7	17.5	0.040	7685370	7312-11
12	9 x 12	12	24.0	9.0	17.5	0.040	7699590	7312-12
13	9 x 12	12	25.0	10.0	17.5	0.040	7679210	7312-13
14	9 x 12	13	27.0	11.0	17.5	0.050	7679480	7312-14

Ø mm	□ mm	mm <sup>2</sup> ⇄	Ø mm	Opening width	Depth gauge	⇄ kg	Code	No.
17	9 x 12	13	31.5	14.0	17.5	0.065	7685880	7312-17
18	9 x 12	15	33.0	14.7	17.5	0.065	7679640	7312-18
19	9 x 12	15	34.5	15.3	17.5	0.065	7686260	7312-19
22	9 x 12	15	39.0	17.0	17.5	0.065	7679720	7312-22

## 7412

### RECTANGULAR REVERSIBLE RATCHET HEAD

9x12

- > For accessing bolts in cramped and hard-to-reach locations, easy to change
- > Forged
- > Chrome-vanadium steel, matt chrome-plated
- > With eject-pin for unlocking
- > Fine-toothed
- > Return angle 5 degrees
- > Max. continuous load of ratchet according to DIN EN ISO 6789:2003 and/or maximum load of cavity



"	■	□mm	∠°	mm	⌀mm	Depth gauge	Continuous load	⚖	Code	No.
1/4	6.3	9 x 12	5	16.6	25	17.5	1/4" = 30 N-m	0.060	7672710	7412-00
3/8	10.0	9 x 12	5	23.2	34	17.5	3/8" = 135 N-m	0.140	7686500	7412-01
1/2	12.5	9 x 12	5	24.2	34	17.5	1/2" = 150 N-m	0.150	7687230	7412-02

## 7612

### RECTANGULAR FIXED SQUARE HEAD

9x12

- > For accessing bolts in cramped and hard-to-reach locations, easy to change
- > Forged
- > Chrome-vanadium steel, matt chrome-plated
- > With eject-pin for unlocking
- > Max. continuous load of ratchet according to DIN EN ISO 6789:2003 and/or maximum load of cavity



"	■	□mm	mm	⌀mm	Depth gauge	Continuous load	⚖	Code	No.
1/4	6.3	9 x 12	14	20	17.5	1/4"/30 N-m	0.070	7672630	7612-00
3/8	10.0	9 x 12	14	20	17.5	3/8"/135 N-m	0.070	7679800	7612-01
1/2	12.5	9 x 12	14	20	17.5	1/2"/150 N-m	0.080	7687900	7612-02

## 7812

### RECTANGULAR BIT HOLDER

9x12

- > For accessing bolts in cramped and hard-to-reach locations, easy to change
- > Forged
- > Chrome-vanadium steel, matt chrome-plated
- > With eject-pin for unlocking



"	■	□mm	mm	⌀mm	Depth gauge	⚖	Code	No.
1/4	6.3	9 x 12	10.0	14	17.5	0.040	2101645	7812-10
5/16	8.0	9 x 12	12.5	16	17.5	0.040	7697970	7812-00

# 7912

## RECTANGULAR WELD-ON FITTING

9x12

- › For accessing bolts in cramped and hard-to-reach locations, easy to change
- › Bear the depth gauges in mind
- › Chrome-vanadium steel 31CrV3



↳ mm	mm	mm	mm	Depth gauge	kg	Code	No.
14	9 x 12	14.5	19	8	0.030	7698190	7912-00

# SUKSE

## RECTANGULAR RING RATCHET SPANNER, REVERSIBLE

9x12

- › 9x12 mm rectangular cavity with pin-locking
- › Flat ring ratchet with UD-profile, fine-toothed
- › With recessed lever change
- › For loosening or fast tightening with high torque transfer
- › Non-glare look thanks to matt chrome-plating, locking insert and pawl manganese-phosphated
- › GEDORE vanadium steel 31CrV3, forged
- › To operate with a 9x12 mm torque wrench or rectangular handle 9x12 mm



mm	mm	°	h	b	Depth gauge	kg	Code	No.
10	9 x 12	7	7.7	21.0	40	0.070	2827735	SUKSE9 10
13	9 x 12	7	9.0	25.7	42	0.090	2827743	SUKSE9 13
17	9 x 12	6	10.6	33.6	45	0.130	2827751	SUKSE9 17
19	9 x 12	6	11.7	36.3	52	0.150	2827778	SUKSE9 19

# AGSE9

## RECTANGULAR HANDLE SE

9x12

- › To operate with rectangular end fittings 9x12
- › For removing bolts or nuts, especially in confined spaces
- › Without torque function
- › GEDORE vanadium steel 31CrV3, matt chrome-plated
- › Non-slip 2-component handle with hanging hole
- › Max. continuous load of cavity according to DIN EN ISO 6789:2003 and/or maximum support load : 150 N-m



mm	L	h	b	kg	Code	No.
9 x 12	267	18.5	22	0.320	2827786	AGSE9

## End fittings 14x18 SE

7118  
RECTANGULAR OPEN END FITTING

14x18

- › For accessing bolts in cramped and hard-to-reach locations, easy to change
- › Forged
- › Chrome-vanadium steel, matt chrome-plated
- › With eject-pin for unlocking



Ø mm	□ mm	mm $\frac{1}{2}$	Ø mm	Depth gauge	$\frac{kg}{lb}$	Code	No.
13	14 x 18	7	30.0	25.0	0.120	7689870	7118-13
14	14 x 18	7	32.0	25.0	0.120	7690020	7118-14
15	14 x 18	7	34.0	25.0	0.120	7690100	7118-15
16	14 x 18	9	35.5	25.0	0.125	7685610	7118-16
17	14 x 18	9	37.0	25.0	0.130	7690370	7118-17
18	14 x 18	9	39.0	25.0	0.130	7686180	7118-18
19	14 x 18	9	41.0	25.0	0.130	7690450	7118-19
21	14 x 18	11	45.0	25.0	0.155	7686420	7118-21
22	14 x 18	11	47.0	25.0	0.150	7690610	7118-22

Ø mm	□ mm	mm $\frac{1}{2}$	Ø mm	Depth gauge	$\frac{kg}{lb}$	Code	No.
24	14 x 18	11	51.0	25.0	0.170	7690880	7118-24
27	14 x 18	13	58.5	32.5	0.185	7690960	7118-27
29	14 x 18	13	63.0	32.5	0.220	2212285	7118-29
30	14 x 18	13	67.5	32.5	0.220	7691260	7118-30
32	14 x 18	13	67.5	32.5	0.220	7687740	7118-32
34	14 x 18	15	74.0	33.5	0.255	1963708	7118-34
36	14 x 18	15	78.0	36.0	0.257	1963716	7118-36
41	14 x 18	15	82.0	40.0	0.261	1963724	7118-41

7218  
RECTANGULAR RING END FITTING

14x18

- › For accessing bolts in cramped and hard-to-reach locations, easy to change
- › Forged
- › Chrome-vanadium steel, matt chrome-plated
- › With eject-pin for unlocking



Ø mm	□ mm	mm $\frac{1}{2}$	Ø mm	Depth gauge	$\frac{kg}{lb}$	Code	No.
13	14 x 18	12.0	21.5	25	0.120	7693120	7218-13
14	14 x 18	12.0	23.0	25	0.120	7693390	7218-14
15	14 x 18	12.0	24.2	25	0.115	7693470	7218-15
16	14 x 18	12.0	25.7	25	0.125	7678320	7218-16
17	14 x 18	12.0	27.2	25	0.125	7693630	7218-17
18	14 x 18	12.0	28.5	25	0.125	7678830	7218-18
19	14 x 18	12.0	30.5	25	0.125	7693710	7218-19
21	14 x 18	15.0	33.0	25	0.140	7678910	7218-21
22	14 x 18	15.0	34.5	25	0.140	7693980	7218-22
24	14 x 18	15.0	37.5	25	0.140	7694280	7218-24

Ø mm	□ mm	mm $\frac{1}{2}$	Ø mm	Depth gauge	$\frac{kg}{lb}$	Code	No.
27	14 x 18	17.5	41.5	31	0.150	7694440	7218-27
30	14 x 18	17.5	45.0	31	0.160	7694790	7218-30
32	14 x 18	17.5	47.5	31	0.165	7695920	7218-32
34	14 x 18	19.0	50.5	31	0.195	7679130	7218-34
36	14 x 18	19.0	53.0	31	0.195	7696220	7218-36
41	14 x 18	19.0	59.0	31	0.225	7696300	7218-41

# 7418

## RECTANGULAR REVERSIBLE RATCHET HEAD

14x18

- > For accessing bolts in cramped and hard-to-reach locations, easy to change
- > Forged
- > Chrome-vanadium steel, matt chrome-plated
- > With eject-pin for unlocking
- > Fine-toothed
- > Return angle 7 degrees
- > Max. continuous load of ratchet according to DIN EN ISO 6789:2003 and/or maximum load of cavity



"	mm	mm	°	mm	mm	Depth gauge	Continuous load	kg	Code	No.
1/2	12.5	14 x 18	7,2	28.8	47	25	1/2" = 340 N-m	0.350	7687580	7418-02
3/4	20.0	14 x 18	7,2	35.5	64	33	3/4" = 400 N-m	0.780	7687660	7418-04

# 7618

## RECTANGULAR FIXED SQUARE HEAD

14x18

- > For accessing bolts in cramped and hard-to-reach locations, easy to change
- > Forged
- > Chrome-vanadium steel, matt chrome-plated
- > With eject pin for unlocking
- > Max. continuous load of ratchet according to DIN EN ISO 6789:2003 and/or maximum load of cavity



"	mm	mm	mm	mm	Depth gauge	Continuous load	kg	Code	No.
1/2	12.5	14 x 18	18	27	25	1/2" = 340 N-m	0.200	7688040	7618-02
3/4	20.0	14 x 18	25	40	25	3/4" = 400 N-m	0.390	7688200	7618-04

# 7818

## RECTANGULAR BIT HOLDER

14x18

- > For accessing bolts in cramped and hard-to-reach locations, easy to change
- > Forged
- > Chrome-vanadium steel, matt chrome-plated
- > With eject-pin for unlocking



"	mm	mm	mm	mm	Depth gauge	kg	Code	No.
5/16	8	14 x 18	12.5	16	25	0.100	7698000	7818-00

# 7918

## RECTANGULAR WELD-ON FITTING

14x18

- > For accessing bolts in cramped and hard-to-reach locations, easy to change
- > Bear the depth gauges in mind
- > Chrome-vanadium steel 31CrV3



mm	mm	mm	mm	Depth gauge	kg	Code	No.
25	14 x 18	21.5	26	12	0.100	7698430	7918-00



## Empty standard packaging

# MODULE SYSTEMS - FLEXIBILITY WITH FLAIR

- › The module system adapts itself exactly to your wishes and requirements. At last, you can assemble your sets completely individually. Exactly and only using the tools you actually need. For every need, our system provides you with the perfect solution. Whether you chose a standard or an individual solution, your DREMASTER®/TORCOFIX torque wrenches with or without accessories, are always stored and transported professionally by virtue of the modular system design.
- › Your set is flexibly alterable and extendible at all times. Just replace or add modules. The modules themselves are delivered with dummy plugs. Simply remove the plugs from the cavities you wish to load with your tools or accessory units. The remaining cavities remain closed - that's what we call neat.
- › You tell us which tools you would like to combine into a set and we will then take care of the rest and you will get your desired set without delay. Finished and ready!

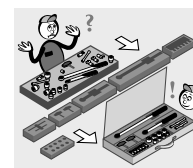
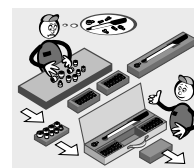
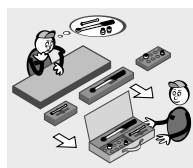

## PLASTIC CASSETTES EMPTY FOR DREMOMETER MINI + AM

### Use:

- › Standard packaging for sets of the torque wrench series DREMOMETER MINI and AM
- › Robust and solid, best for storage and transport

### Features:

- › With foam rubber inlay and nest-holes for the accessories

### Scope of delivery:

- › Empty black plastic cassettes with foam inlay
- › Delivery in sturdy cardboard packaging



## SHEET METAL CASE EMPTY FOR DREMOMETER A-F

### Use:

- › Standard packaging for sets of the torque wrench series DREMOMETER A-F
- › Robust and solid, best for storage and transport

### Features:

- › With integrated metal-flight and nest-holes for the accessories
- › Hinges, locks and hand grip made of steel
- › GEDORE blue powder-coated

### Scope of delivery:

- › Sheet metal case, empty
- › Delivery in sturdy cardboard packaging



Description	L	W	H		Code	No.
<b>Plastic cassette + foam inlay for DREMO MINI</b>	275	150	42	0.296	1986805	753-88
<b>Plastic cassette + foam insert for DREMO AM</b>	275	150	42	0.310	7620910	8554-99

Description	L	W	H		Code	No.
<b>Sheet metal case for DREMO A</b>	370	115	50	1.200	7621050	8560-90
<b>Sheet metal case for DREMO B</b>	485	115	52	1.698	7621130	8561-90
<b>Sheet metal case for DREMO BC/C</b>	630	115	52	1.950	7621210	8562-90
<b>Sheet metal case for DREMO D/DS</b>	830	165	73	3.713	7621480	8563-90
<b>Sheet metal case for DREMO DR/DX</b>	830	165	73	3.656	7622100	8571-90
<b>Sheet metal case for DREMO E / EK</b>	945	270	100	10.300	7621560	8564-90
<b>Sheet metal case for DREMO F</b>	1040	175	100	6.700	1742876	8572-90



# TORQUE MULTIPLIERS DREMOPLUS ALU

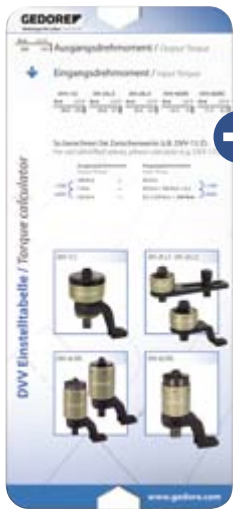

GEDORE		DVV-13Z	
Model	Serien-No.	Ratio	
2011	DV02.00018	1:5	
Max. Input Torque	270 N·m	Max. Output Torque	1300 N·m
	200 lbf·ft		950 lbf·ft

INPUT		OUTPUT	
N·m	lbf·ft	N·m	lbf·ft
10.9	8.7	50	40
21.1	14.7	100	70
41.7	31.2	200	150
58.8	41.3	285	200
80.6	61.1	395	300
91.9	71.6	450	350
115.0	82.0	560	400
156.3	112.2	765	550
174.2	122.7	850	600
198.4	143.8	965	700
216.8	154.5	1050	750
227.4	165.2	1100	800
237.9	175.7	1150	850
248.0	185.9	1200	900
258.2	190.1	1250	920
268.9	196.5	1300	950

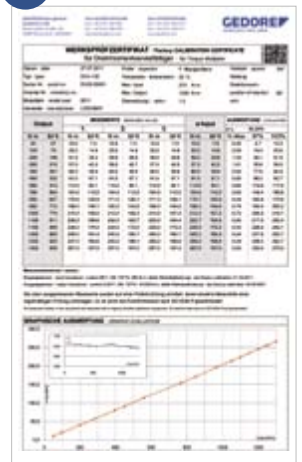

## Safety Plus Your advantage

- > The slender, lighter structure of the appliances ensures convenient and safe working - even where conditions are particularly cramped.
- > Repetition-accurate and precise results - supported by individual factory test certificates - ensure a maximum degree of job safety.
- > High degree of resilience and long life of the appliances attributable to a low-backlash planet gear with Ceramic-Teflon® coating.
- > A 30% + lighter steel housing thanks to the use of high-performance aluminium.
- > Each torque multiplier is examined as to its torque range at the factory and provided with an individual factory test certificate.
- > Precise, reliable figures - even under extreme climatic conditions
- > Easy to operate: The most common INPUT/OUTPUT torques on the torque multiplier

# WHAT MAKES FOR A GOOD TORQUE MULTIPLIER?

- > Light yet with the appliance remaining sturdy.
- > The torque and repeatability accuracy is at  $\pm 3\%$ . Only in this way is dependable screw tightening work assured with reproducible accuracy.
- > Both the torque settings and individual appliance components can be traced back.
- > A factory test certificate ensures traceability of operations on the basis of ISO 9000. An individual factory test certificate is prepared for each and every torque multiplier and contains comprehensive information on readings, deviations, torque sensors and environmental influences.
- > Particularly when unloosening seized screw connections, minimised impacts on the tooth flanks appear in a low backlash planet gear. The greater the precision with which the components fit together, the more stable the overall structure and the longer the service life. This precision can only be assured by a high in-house manufacturing proportion and consistent quality checks.
- > An overload safety mechanism should be integrated at torques upwards of 2000 N·m. No damage occurs to the gear should it be overloaded.



## Selection criteria

### 1. Torque

Select your torque multiplier on the basis of the maximum output torque.

### 2. Loading factor and frequency (load spectrum)

It would be wrong to constantly operate the appliance at its maximum capacity - just as it would be for any machine or any car. This also holds good for the choice of the torque multiplier. Permanently operating a torque multiplier for screw-tightening applications at maximum torque may impact negatively on its service life.

### 3. Supporting situation

Various supporting situations may be a determining factor in the selection of the torque multiplier.

**Support at a raised position:** The L-form reaction arm would be suitable should you want to attach the reaction arm to a point above the screwing-tightening level. A warning here in that the inputted bending forces result in a reduction of the maximum permitted torque!

**Support at the level of the screw:** Our recommendation - should you want to attach the reaction arm at the screw-tightening level - is either for a Z-form reaction arm or the straight L-form with adjustable reaction square.

### 4. Anti-wind-up ratchet

A minimum 180° torque wrench field of movement should be on hand. As such, the recommendation is for an appliance complete with an anti-wind-up ratchet. In this way, pre-tension in the appliance is maintained and does not need to be re-created with each lift.

## i Application case

8,000 screws a year are to be tightened at 4000 N·m. The following calculation needs to be carried out on the basis of the diagram to find the right appliance:







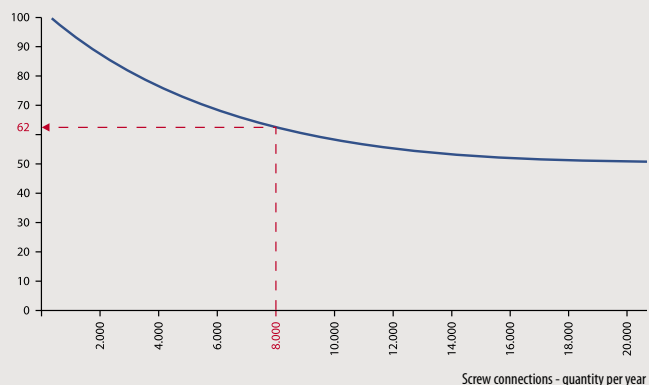





$$\frac{\text{Torque} \times 100\%}{\text{Loading}} = \frac{4.000 \text{ N}\cdot\text{m} \times 100\%}{62\%}$$

Choose an appliance with a max. 6452 N·m torque. The DVV-60ZRS would be ideally suitable here.

Plan for a sufficient reserve in unloosening the screw connection. The torque needed to loosen a screw connection can be many times the tightening torque.



# PRODUCT OVERVIEW TORQUE MULTIPLIERS DREMOPLUS ALU

Series / Type	Accuracy +/-	Drive	Output drive	Ratio	Reaction arm	Anti-wind-up ratchet	Overload safety mechanism				Range N·m tested and certified
							Sun gear	Shearing square	Slipper non-destructive	Ceramic-Teflon® coating	
 DVV-13 Z	3 %	1/2"	3/4"	1:5	Z	○	●	○	○	○	250 – 1.300 N·m
 DVI-20 Z	3 %	3/4"	1"	1:4	Z	○	○	●	○	○	500 – 2.000 N·m
 DVI-20 L	3 %	3/4"	1"	1:4	L	○	○	●	○	○	500 – 2.000 N·m
 DVI-28 Z	3 %	3/4"	1"	1:5,5	Z	○	○	●	○	○	500 – 2.800 N·m
 DVI-28 L	3 %	3/4"	1"	1:5,5	L	○	○	●	○	○	500 – 2.800 N·m
 DVV-40 Z	3 %	1/2"	1"	1:16	Z	○	○	○	●	●	500 – 4.000 N·m
 DVV-40 ZRS	3 %	1/2"	1"	1:16	Z	●	○	○	●	●	500 – 4.000 N·m
 DVV-60 ZRS	3 %	3/4"	1.1/2"	1:18	Z	●	○	○	●	●	700 – 6.000 N·m
 DVV-80 ZRS	3 %	3/4"	1.1/2"	1:22	Z	●	○	○	●	●	750 – 8.000 N·m
 DVV-100 RS	3 %	3/4"	1.1/2"	1:28,5	Z	●	○	○	●	●	1.000 – 10.000 N·m
 DVV-130 ZRS	3 %	3/4"	1.1/2"	1:39	Z	●	○	○	●	●	1.200 – 13.000 N·m
 DVV-540 RS	3 %	3/4"	2.1/2"	1:175	–	●	○	○	●	●	7.000 – 54.000 N·m



## Working principle

### Torque - velocity

The chart representation elucidates the principle of torque multiplication. Let us assume a 60 N-m input torque and a 240 N-m output torque.

At a 1:4 ratio, 4 revolutions are needed at the input for 1 revolution with a 240 N-m torque to be obtained at the output.

This is substantiated in terms of the physical formula:

**Power = torque x revolution**

With gear efficiency deducted, the output power is to be considered as a constant equal to the input power. Thus multiplication of the torque can only be obtained from an increased number of revolutions at the input.

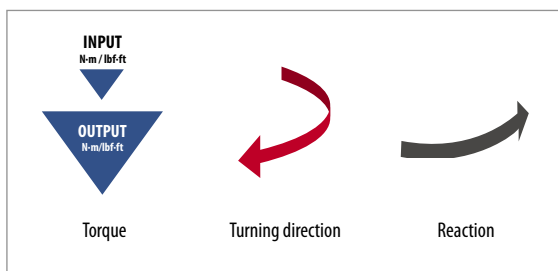
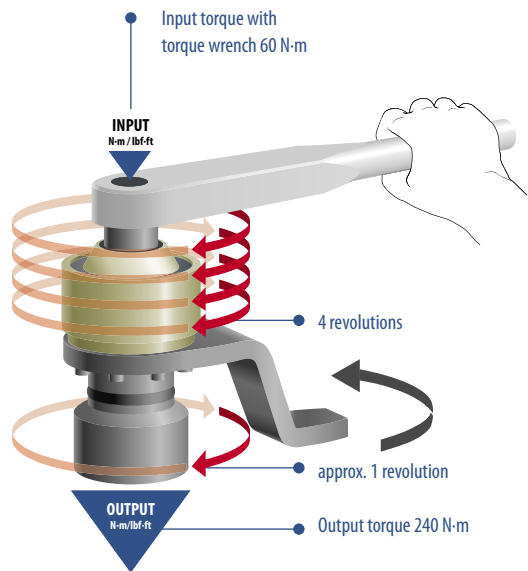

## Working principle

### Force and reaction

When working with a torque multiplier, torsion wind-up is built up in the gear when the screw is tightened. This stress must be reduced. A reaction absorbed by reaction arm and abutment is produced.

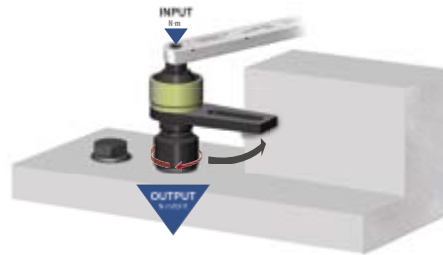

L-form reaction arm without adjustable reaction square:

The reaction acts on the wall. Is possible, but the tilting moment which arises causes the max. permitted torque to drop by 20 %.

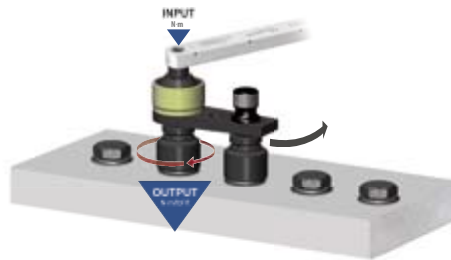

L-form reaction arm with adjustable reaction square:

The reaction acts on the adjacent impact socket.

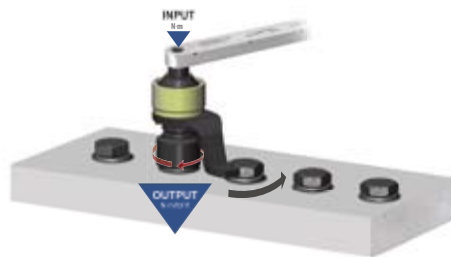

Reaction arm in Z-form:

The reaction acts on the adjacent screw connection



## Choosing the right reaction arm

### Reaction arm Z-form



- > A flexible offset reaction arm which has proved itself as the standard solution.
- > Supporting situations are, for instance, adjoining screws, walls, machine parts and other stable abutments.
- > This reaction arm can be ideally used where conditions are quite cramped.

## Choosing the right reaction arm

### Reaction arm L-form

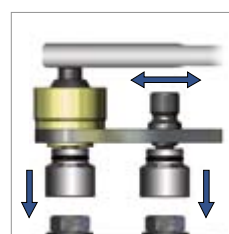

- > This straight reaction arm with adjustable reaction square is admirably suited for flange screw connections.
- > The L-form reaction arm has in terms of support a larger radius than the Z-Form.

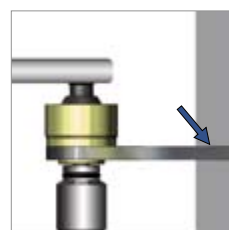

The L-form is also ideal for those points above the screw-tightening level. However, the resulting tilting moment causes the max. permitted torque to drop by 20%.



## Choosing the right torque assembly tool for screws and nuts

- > It is vital that use is made of a torque wrench complete with ratchet function (integrated or separate) for torque multipliers without anti-wind-up ratchet.
- > For models with an anti-wind-up ratchet, we recommend the use of torque tools complete with ratchet function (integrated or separate) - for ease of working.



# DREMOPLUS ALU FAMILY 1

## DVV-40Z, DVV-40ZRS - DVV-540RS

Convenient: Integrated "RS" anti-wind-up ratchet for safe working. Bi-directional (apart from model DVV-40Z)

Lightweight and slim: High-performance aluminium housing is 30 % lighter than a steel one.

Low backlash, 2-stage planet gear for a long service life

Stable, shuttle-impacted gear housing

Flexible: With detachable Z-form reaction arm, can be optionally retrofitted with L-form reaction arm and adjustable reaction square

A 1", 1.1/2" or 2.1/2" output square with drill hole for impact sockets with safety pin and ring

1/2" or 3/4" input square

Overload safety mechanism: Non-destructive overload safety mechanism - "Slipper" - filed as a patent. Triggers overload at 10% and again clicks into place. Clockwise and anti-clockwise

A coating of the tooth flanks consisting of ceramic and teflon enables the gear to be constantly lubricated with a minimum of grease.

A Z-form forged reaction arm of chrome-vanadium steel absorbs any countering force that arises. Optional: L-form reaction arm on request

### 100% quality check

- > Delivery including factory test certificate
- > The most common INPUT/OUTPUT torques on the torque multiplier

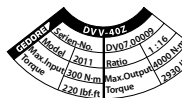

INPUT		OUTPUT	
N-m	lbf.ft	N-m	lbf.ft
34.8	25.7	550	40
44.3	32.7	600	45
53.8	39.7	650	50
63.3	46.7	700	55
72.8	53.7	750	60
82.3	60.7	800	65
91.8	67.7	850	70
101.3	74.7	900	75
110.8	81.7	950	80
120.3	88.7	1000	85
129.8	95.7	1050	90
139.3	102.7	1100	95
148.8	109.7	1150	100
158.3	116.7	1200	105
167.8	123.7	1250	110
177.3	130.7	1300	115
186.8	137.7	1350	120
196.3	144.7	1400	125
205.8	151.7	1450	130
215.3	158.7	1500	135
224.8	165.7	1550	140
234.3	172.7	1600	145
243.8	179.7	1650	150
253.3	186.7	1700	155
262.8	193.7	1750	160
272.3	200.7	1800	165
281.8	207.7	1850	170
291.3	214.7	1900	175
300.8	221.7	1950	180
310.3	228.7	2000	185
319.8	235.7	2050	190
329.3	242.7	2100	195
338.8	249.7	2150	200
348.3	256.7	2200	205
357.8	263.7	2250	210
367.3	270.7	2300	215
376.8	277.7	2350	220
386.3	284.7	2400	225
395.8	291.7	2450	230
405.3	298.7	2500	235
414.8	305.7	2550	240
424.3	312.7	2600	245
433.8	319.7	2650	250
443.3	326.7	2700	255
452.8	333.7	2750	260
462.3	340.7	2800	265
471.8	347.7	2850	270
481.3	354.7	2900	275
490.8	361.7	2950	280
500.3	368.7	3000	285
509.8	375.7	3050	290
519.3	382.7	3100	295
528.8	389.7	3150	300
538.3	396.7	3200	305
547.8	403.7	3250	310
557.3	410.7	3300	315
566.8	417.7	3350	320
576.3	424.7	3400	325
585.8	431.7	3450	330
595.3	438.7	3500	335
604.8	445.7	3550	340
614.3	452.7	3600	345
623.8	459.7	3650	350
633.3	466.7	3700	355
642.8	473.7	3750	360
652.3	480.7	3800	365
661.8	487.7	3850	370
671.3	494.7	3900	375
680.8	501.7	3950	380
690.3	508.7	4000	385
699.8	515.7	4050	390
709.3	522.7	4100	395
718.8	529.7	4150	400
728.3	536.7	4200	405
737.8	543.7	4250	410
747.3	550.7	4300	415
756.8	557.7	4350	420
766.3	564.7	4400	425
775.8	571.7	4450	430
785.3	578.7	4500	435
794.8	585.7	4550	440
804.3	592.7	4600	445
813.8	599.7	4650	450
823.3	606.7	4700	455
832.8	613.7	4750	460
842.3	620.7	4800	465
851.8	627.7	4850	470
861.3	634.7	4900	475
870.8	641.7	4950	480
880.3	648.7	5000	485
889.8	655.7	5050	490
899.3	662.7	5100	495
908.8	669.7	5150	500
918.3	676.7	5200	505
927.8	683.7	5250	510
937.3	690.7	5300	515
946.8	697.7	5350	520
956.3	704.7	5400	525
965.8	711.7	5450	530
975.3	718.7	5500	535
984.8	725.7	5550	540
994.3	732.7	5600	545
1003.8	739.7	5650	550
1013.3	746.7	5700	555
1022.8	753.7	5750	560
1032.3	760.7	5800	565
1041.8	767.7	5850	570
1051.3	774.7	5900	575
1060.8	781.7	5950	580
1070.3	788.7	6000	585
1079.8	795.7	6050	590
1089.3	802.7	6100	595
1098.8	809.7	6150	600
1108.3	816.7	6200	605
1117.8	823.7	6250	610
1127.3	830.7	6300	615
1136.8	837.7	6350	620
1146.3	844.7	6400	625
1155.8	851.7	6450	630
1165.3	858.7	6500	635
1174.8	865.7	6550	640
1184.3	872.7	6600	645
1193.8	879.7	6650	650
1203.3	886.7	6700	655
1212.8	893.7	6750	660
1222.3	900.7	6800	665
1231.8	907.7	6850	670
1241.3	914.7	6900	675
1250.8	921.7	6950	680
1260.3	928.7	7000	685
1269.8	935.7	7050	690
1279.3	942.7	7100	695
1288.8	949.7	7150	700
1298.3	956.7	7200	705
1307.8	963.7	7250	710
1317.3	970.7	7300	715
1326.8	977.7	7350	720
1336.3	984.7	7400	725
1345.8	991.7	7450	730
1355.3	998.7	7500	735
1364.8	1005.7	7550	740
1374.3	1012.7	7600	745
1383.8	1019.7	7650	750
1393.3	1026.7	7700	755
1402.8	1033.7	7750	760
1412.3	1040.7	7800	765
1421.8	1047.7	7850	770
1431.3	1054.7	7900	775
1440.8	1061.7	7950	780
1450.3	1068.7	8000	785
1459.8	1075.7	8050	790
1469.3	1082.7	8100	795
1478.8	1089.7	8150	800
1488.3	1096.7	8200	805
1497.8	1103.7	8250	810
1507.3	1110.7	8300	815
1516.8	1117.7	8350	820
1526.3	1124.7	8400	825
1535.8	1131.7	8450	830
1545.3	1138.7	8500	835
1554.8	1145.7	8550	840
1564.3	1152.7	8600	845
1573.8	1159.7	8650	850
1583.3	1166.7	8700	855
1592.8	1173.7	8750	860
1602.3	1180.7	8800	865
1611.8	1187.7	8850	870
1621.3	1194.7	8900	875
1630.8	1201.7	8950	880
1640.3	1208.7	9000	885
1649.8	1215.7	9050	890
1659.3	1222.7	9100	895
1668.8	1229.7	9150	900
1678.3	1236.7	9200	905
1687.8	1243.7	9250	910
1697.3	1250.7	9300	915
1706.8	1257.7	9350	920
1716.3	1264.7	9400	925
1725.8	1271.7	9450	930
1735.3	1278.7	9500	935
1744.8	1285.7	9550	940
1754.3	1292.7	9600	945
1763.8	1299.7	9650	950
1773.3	1306.7	9700	955
1782.8	1313.7	9750	960
1792.3	1320.7	9800	965
1801.8	1327.7	9850	970
1811.3	1334.7	9900	975
1820.8	1341.7	9950	980
1830.3	1348.7	10000	985



1:16 4.000 N-m      1:18 6.000 N-m      1:22 8.000 N-m      1:28.5 10.000 N-m      1:39 13.000 N-m      1:175 54.000 N-m

# DVV-40Z + DVV-40ZRS

## TORQUE MULTIPLIER DREMOPLUS ALU

4000 N·m / 2930 lbf·ft



**Particularly suitable for:**

- > Machinery and plant engineering
- > Cable cars, lifts and masts
- > Heavy industry, construction sites
- > Bridge construction
- > Shipbuilding, aircraft and railway construction
- > Refineries, plastics industry
- > Power plants of all kinds

**Features:**

- > Mechanical hand torque multiplier for controlled screw tightening and unloosening screw connections
- > With a two-stage planet gear
- > High-performance aluminium housing
- > Torque multiplication ratio: 1:16
- > DVV-40ZRS model with anti-wind-up ratchet (RS)
- > With non-destructive "Slipper" overload safety mechanism for gear protection - clockwise and anticlockwise
- > Z-form, offset reaction arm depending on model made of chrome-vanadium steel
- > Can be optionally retrofitted with L-form straight reaction arm - with adjustable reaction arm - of lightweight metal
- > Guaranteed accuracy: Better than +/- 3 % tolerance
- > For operation in combination with a torque wrench
- > 2 models for a maximum load at around a max. 4000 N·m
- > Output square with drill hole for impact sockets with safety pin and ring

**Scope of delivery:**

- > Torque Multiplier DREMOPLUS ALU
- > With Z-form offset reaction arm
- > Delivery in sturdy shipping case with foam insert
- > Factory test certificate and setting table
- > Detailed technical information is available on request

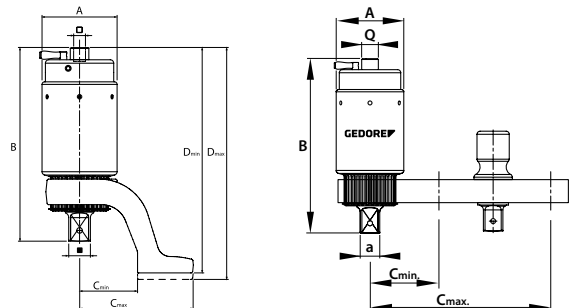

max. N-m-Output	max. lbf-ft-Output	⚙️	□ " C	■ " D	A	B	C <sub>min</sub>	C <sub>max</sub>	D <sub>min</sub>	D <sub>max</sub>	max. N-m-Input	max. lbf-ft-Input	⚖️	Code	No.
4000	2930	1:16	1/2	1	88	212	71	136	250	256	300	220	5.4	2653087	DVV-40Z
4000	2930	1:16	1/2	1	88	227	71	136	264	270	310	230	5.7	2653109	DVV-40ZRS

**OPTIONAL ACCESSORIES:**

Description	A	B	C <sub>min</sub>	C <sub>max</sub>	⚖️	Code	No.
Reaction arm Z-form offset for DVV40	88	212	71	136	1.5	2653176	RZ-DVV40
Reaction arm L-form straight for DVV40, 1"	88	212	86	234	1.7	2653184	RL-DVV40



# DVV-60ZRS - DVV-130ZRS

## TORQUE MULTIPLIER DREMOPLUS ALU

6000-13000 N·m / 4400-9530 lbf·ft



**Particularly suitable for:**

- > Machinery and plant engineering
- > Cable cars, lifts and masts
- > Heavy industry, construction sites
- > Bridge construction
- > Shipbuilding, aircraft and railway construction
- > Refineries, plastics industry
- > Power plants of all kinds

**Features:**

- > Mechanical hand torque multiplier for controlled screw tightening and unloosening screw connections
- > With a two-stage planet gear
- > High-performance aluminium housing
- > Torque multiplication ratio: 1:18, 1:22, 1:28.5, 1:39
- > All models with anti-wind-up ratchet (RS)
- > With non-destructive "Slipper" overload safety mechanism for gear protection - clockwise and anticlockwise
- > Z-form, offset reaction arm depending on model made of chrome-vanadium steel
- > Can be optionally retrofitted with L-form straight reaction arm - with adjustable reaction arm - of lightweight metal
- > Guaranteed accuracy: Better than +/- 3 % tolerance
- > For operation in combination with a torque wrench
- > 4 models for maximum load in the range between max. 6000 N-m and max. 13000 N-m
- > Output square with drill hole for impact sockets with safety pin and ring

**Scope of delivery:**

- > Torque Multiplier DREMOPLUS ALU
- > With Z-form offset reaction arm
- > Delivery in sturdy shipping case with foam insert
- > Factory test certificate and setting table
- > Detailed technical information is available on request

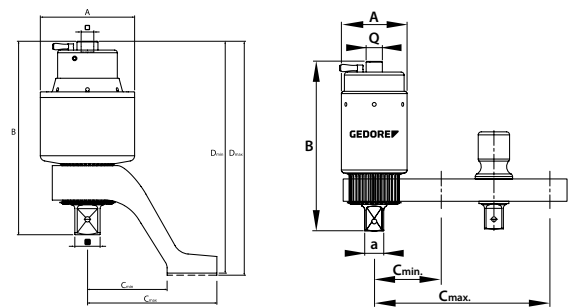

max. N-m-Output	max. lbf-ft-Output	•:•	□ " C	■ " D	A	B	C <sub>min</sub>	C <sub>max</sub>	D <sub>min</sub>	D <sub>max</sub>	max. N-m-Input	max. lbf-ft-Input	kg	Code	No.
6000	4400	1:18	3/4	1.1/2	102	257	110	190	316	324	400	300	10.5	2653117	DVV-60ZRS
8000	5870	1:22	3/4	1.1/2	128	277	110	190	338	342	420	310	13.4	2653125	DVV-80ZRS
10000	7330	1:28,5	3/4	1.1/2	142	292	120	216	350	356	410	305	13.9	2653133	DVV-100ZRS
13000	9530	1:39	3/4	1.1/2	175	306	(126)	(229)	(372)	(379)	380	280	20.9	2653141	DVV-130ZRS

**OPTIONAL ACCESSORIES:**

Description	A	B	C <sub>min</sub>	C <sub>max</sub>	kg	Code	No.
Reaction arm Z-form offset for DVV60	102	257	110	190	3.9	2653192	RZ-DVV60
Reaction arm Z-form offset for DVV80	128	277	110	190	4.3	2653206	RZ-DVV80
Reaction arm Z-form offset for DVV100	142	242	120	216	3.0	2653222	RZ-DVV100
Reaction arm Z-form offset for DVV130	175	306	126	229	3.9	2653230	RZ-DVV130
Reaction arm L-form straight for DVV60-80, 1.1/2"	102/128	256,2/276,5	120/120	315/315	4.0	2654091	RL-DVV60-80

# DVV-540RS

## TORQUE MULTIPLIER DREMOPLUS ALU

54000 N·m / 40330 lbf·ft

**Particularly suitable for:**

- > Heavy industry
- > Oil industry
- > Petrochemicals

**Features:**

- > Mechanical hand torque multiplier for controlled screw tightening and unloosening screw connections
- > With a three-stage planet gear
- > High-performance aluminium housing
- > Chrome-vanadium steel reaction arm
- > Multiplication at the ratio of 1:175
- > With anti-wind-up ratchet (RS)
- > With non-destructive "Slipper" overload safety mechanism for gear protection - clockwise and anticlockwise
- > With fixture for welding on a reaction arm (optional)
- > Guaranteed accuracy: Better than +/- 3 % tolerance
- > For operation in combination with a torque wrench
- > 1 model for a maximum load of around a max. 54000 N·m
- > Output square with drill hole for impact sockets with safety pin and ring

**Scope of delivery:**

- > Torque Multiplier DREMOPLUS ALU
- > Delivery in a sturdy crate on pallet
- > Setting table
- > Detailed technical information is available on request

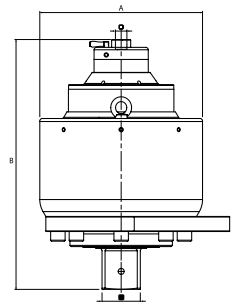

max. N·m-Output	max. lbf-ft-Output	Ratio	" C	" D	A	B	max. N·m-Input	max. lbf-ft-Input	kg	Code	No.
54000	40330	1:175	3/4	2.1/2	270	415	380	280	64.6	2653168	DVV-540RS



**SPECIAL REACTION ARMS CAN BE OBTAINED ON REQUEST INCLUDING TECHNICAL ADVICE.**

- > Just turn to us - We would be glad to tender any advice.
- > Any problems you have represent our assignments!



# DREMOPLUS ALU FAMILY 2

## DVI-20L/Z AND DVI-28L/Z



**DVI-20Z and DVI-28Z**

- > Reaction arm Z-form offset
- > fix integrated

**DVI-20L and DVI-28L**

- > Reaction arm L-form with adjustable reaction square drive
- > fix integrated

### 100% quality check

- > Delivery including factory test certificate
- > The most common INPUT/OUTPUT torques on the torque multiplier

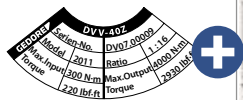

INPUT		OUTPUT	
N-m	lbf.ft	N-m	lbf.ft
34.8	25.7	550	40
46.3	33.7	800	59
61.7	45.2	1000	74
74.7	54.8	1500	110
81.8	60.0	1700	125
81.8	60.0	1700	125
117.8	85.8	2500	183
128.3	93.8	2700	198
138.8	101.1	3000	220
148.7	108.4	3100	227
158.2	115.4	3200	234
168.8	123.0	3300	241
178.8	130.8	3400	248
188.8	138.1	3500	255
198.8	145.4	4000	294
208.8	152.8	4000	294



1:4  
2.000 N-M



1:4  
2.000 N-M



1:5,5  
2.000 N-M



1:5,5  
2.000 N-M



# DVI-20L/Z + DVI-28L/Z

## TORQUE MULTIPLIER DREMOPLUS ALU

2000-2800 N·m / 1500-2050 lbf·ft



**Particularly suitable for:**

- > Industry, construction sites, car and truck garages, agricultural technology, construction machinery
- > Bridge, aircraft and railway construction, shipbuilding, refineries
- > Machinery and plant engineering, maintenance

**Features:**

- > Mechanical hand torque multiplier for controlled screw tightening and unloosening screw connections
- > With a single-stage planet gear
- > High-performance aluminium housing
- > Multiplication at the ratio of 1:4, 1:5.5
- > Guaranteed accuracy: Better than +/- 3 % tolerance
- > For operation in combination with a torque wrench
- > 2 models for maximum load in the range between max. 2000 N-m and 2800 N-m
- > Z model: with Z-form, offset reaction arm of chrome-vanadium steel
- > L model: with L-form straight reaction arm - with adjustable reaction square - of lightweight metal
- > Output square with drill hole for impact sockets with safety pin and ring

**Scope of delivery:**

- > Torque Multiplier DREMOPLUS ALU
- > With firmly integrated reaction arm of an Z- or L-form depending on model
- > Delivery in sturdy shipping case with foam insert
- > Factory test certificate and setting table
- > Detailed technical information is available on request

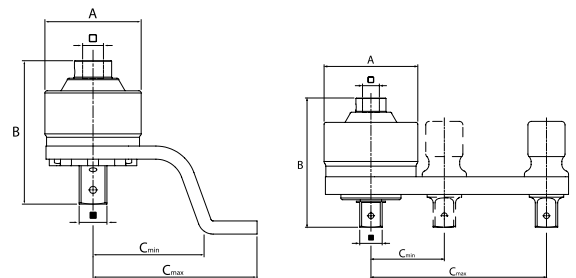

max. N-m-Output	max. lbf-ft-Output	Reaction arm	••• C	□ " C	■ " D	A	B	C <sub>min</sub>	C <sub>max</sub>	max. N-m-Input	max. lbf-ft-Input	kg	Code	No.
2000	1500	offset	1:4	3/4	1	88	131	100	150	580	430	2.9	2653265	DVI-20Z
2800	2050	offset	1:5,5	3/4	1	106	146	100	150	550	410	3.9	2653273	DVI-28Z
2000	1500	straight	1:4	3/4	1	88	131	73	152	580	430	3.0	2653249	DVI-20L
2800	2050	straight	1:5,5	3/4	1	106	146	83	199	550	410	4.1	2653257	DVI-28L

**OPTIONAL ACCESSORIES:**

Description	kg	Code	No.
Reaction arm Z-form offset for DVI20	1.100	2653281	RZ-DVI20
Reaction arm L-form straight for DVI20, 1"	1.200	2653303	RL-DVI20
Spare square 1" for DVI20	0.300	2653346	E-VKT-DVI20
Reaction arm Z-form offset for DVI28	1.500	2653311	RZ-DVI28
Reaction arm L-form straight for DVI28, 1"	1.700	2653338	RL-DVI28
Spare square 1" incl. ring for DVI28	0.500	2670526	E-VKR-DVI28



# DREMOPLUS ALU FAMILY 3

## DVV-13Z



### 100% quality check

- > Delivery including factory test certificate
- > The most common INPUT/OUTPUT torques on the torque multiplier



### The GEDORE maintenance service

#### One promoting service life and safety

- > Regular maintenance can considerably lengthen the service life of your GEDORE torque multiplier and also contribute to your safety.
- > Maintenance involves our qualified personnel examining the individual components, testing their functional precision and verifying the factory certificate.
- > In such an instance, we would willingly draft an estimate for you.
- > We will, of course, continue to support you should you have any questions on and problems with the former DREMOPLUS models - **just get in touch with us!**
- > Should a guarantee case arise - then either hand in the appliance to your dealer - who will concern himself with what is then to follow - or send it directly for repairs to the Lösomat manufacturer or the nearest GEDORE agency.

# DVV-13Z

## TORQUE MULTIPLIER DREMOPLUS ALU

1300 N·m / 950 lbf·ft



**Particularly suitable for:**

- > Industry, construction sites, car and truck garages, agricultural technology
- > Bridge, aircraft and railway construction, shipbuilding, refineries
- > Machinery and plant engineering, maintenance

**Features:**

- > Mechanical hand torque multiplier for controlled screw tightening and unloosening screw connections
- > With a single-stage planet gear
- > High-performance aluminium housing
- > With Z-form offset reaction arm of chrome-vanadium steel
- > Can be optionally retrofitted with L-form straight reaction arm - with adjustable reaction arm - of lightweight metal
- > Multiplication at the ratio of 1:5
- > Guaranteed accuracy: Better than +/- 3 % tolerance
- > For operation in combination with a torque wrench
- > 1 model for a maximum load of around a max. 1300 N-m
- > Also available as set (No. DVV-13ZG) with three different impact sockets - sizes 27, 30, 32 mm
- > Output square with drill hole for impact sockets with safety pin and ring



DVV-13Z

**Scope of delivery:**

- > Torque Multiplier DREMOPLUS ALU
- > With Z-form offset reaction arm
- > Delivery in sturdy shipping case with foam insert
- > Factory test certificate and setting table
- > Detailed technical information is available on request



DVV-13ZG

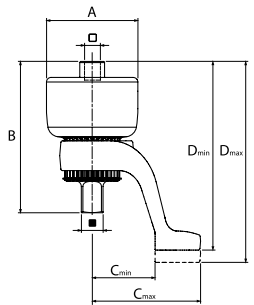

**DVV-13Z**

max. N-m-Output	max. lbf-ft-Output	••⚙️	□" C	■" D	A	B	C <sub>min</sub>	C <sub>max</sub>	D <sub>min</sub>	D <sub>max</sub>	max. N-m-Input	max. lbf-ft-Input	kg	Code	No.
1300	950	1:5	1/2	3/4	80	133	56	95	165	173	270	200	1.9	2653370	DVV-13Z

**DVV-13ZG**

Contents	max. N-m-Output	max. lbf-ft-Output	••⚙️	□" C	■" D	A	B	C <sub>min</sub>	C <sub>max</sub>	D <sub>min</sub>	D <sub>max</sub>	max. N-m-Input	max. lbf-ft-Input	kg	Code	No.
DVV-13Z K 32 27 K 32 30 K 32 32	1300	950	1:5	1/2	3/4	80	133	56	95	165	173	270	200	3.0	2653389	DVV-13ZG

**OPTIONAL ACCESSORIES**

Description	A	B	C <sub>min</sub>	C <sub>max</sub>	kg	Code	No.
Reaction arm L-form straight for DVV-13, 3/4"	80	133	60	159	0.800	2653400	RL-DVV13
Reaction arm Z-form offset for DVV-13	80	133	56	95	0.600	2653397	RZ-DVV13
Sun gear for DVV-13					0.090	2684233	E-S-DVV13



---

# SCREWDRIVERS

---

## 3C-SCREWDRIVER

> 345



---

## 3C-SCREWDRIVER WITH STRIKING CAP

> 350



---

## SCREWDRIVER WITH WOODEN HANDLE

> 351



---

## ELECTRONIC SCREWDRIVER

> 352



---

## T-HANDLES

> 354



---

## HEXAGON ALLEN KEYS

> 357



---

## VARIOUS

> 363



# GEDORE SCREWDRIVERS

powerful, unerring, absolute precision, wear-resistant

- > The torque required by the German Standards Institute (DIN/ISO) is exceeded considerably
- > The ideal all-rounder for screws in wood, plastic and metal



**+** **Striking cap**  
Seized screws are loosened by gently knocking on the striking cap. Full-length blade transfers the full 100% impact force onto the blade tip.



**+** **Infoprint**  
Head marking for specifically and rapidly accessing the right screwdriver



**+** **Useful hanging hole**



**+** **Ergonomic handle design**

- > Ergonomic grip design for optimum power transfer
- > Maximum force involving minimum effort
- > Extensive contact surface with the hand
- > Ergonomically appropriately placed hard and soft elements give the grip its GEDORE typical kind-to-hands feel
- > Suitable for small hands, large hands and for both right and left-handers



**+** **3-component handle**

- > Soft fast turning zone with hard power point - gets the power there quickly
- > Power point also ensures that the forefinger reliably guides the blade
- > The hard core is inside the grip. It takes up the force from the external components and easily transfers it to the shaft. The hard core can be seen at the head marking



**+** **Hexagon blade with additional hexagon bolster**



**+** **Tempered blade**

- > Blade from GEDORE molybdenum-vanadium-Plus tempered steel for hardness, elasticity and resistance to wear
- > Blade fully tempered for a long service life
- > Blade injected as a positive fit into the plastic core and matt chrome-plated

**+** **Precision-made blade tip**  
Ensures optimum power transfer onto the screw head





3C-SCREWDRIVER

## 2150 3C-SCREWDRIVER

for slotted head screws

- > Acc. to DIN ISO 2380-2, blade tip acc. to DIN ISO 2380-1 Form A
  - > 3-component handles Power-Grip<sup>3</sup> with hanging hole
  - > Ergonomic handle design enables precise and fatigue-free working
  - > Positive-fit joint of handle and blade for optimum transmission of force
  - > Type of drive marked at end of the handle
  - > Blade from GEDORE molybdenum-vanadium-Plus tempered steel
- \* Length not standardised



mm	mm	mm	*	mm	Ø	kg	Code	No.
3.0	0.5	80	*	165	3,0	0.039	6679270	2150 3
3.5	0.6	75		160	3,5	0.055	2822644	2150 3,5
4.0	0.8	100		185	4,0	0.061	6679350	2150 4
4.5	0.8	90	*	190	4,0	0.100	2822652	2150 4,5
5.5	1.0	100		200	5,0	0.093	6679430	2150 5,5
6.5	1.2	150		260	6,0	0.128	6679510	2150 6,5
8.0	1.2	150		270	7,0	0.170	6679780	2150 8
8.0	1.6	175		295	7,0	0.222	2822660	2150 8-175
10.0	1.6	200		320	8,0	0.203	6679860	2150 10
10.0	1.6	300	*	420	8,0	0.222	2822679	2150 10-300
12.0	2.0	200		320	9,0	0.257	6679940	2150 12
12.0	2.0	250		370	9,0	0.222	2822687	2150 12-250

VDE 2170

>575

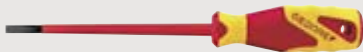

## 2153 3C-SCREWDRIVER

for slotted head screws, stubby

- > Acc. to DIN ISO 2380-2A, blade tip acc. to DIN ISO 2380-1 Form B
- > For confined spaces
- > 3-component handles Power-Grip<sup>3</sup> with hanging hole
- > Ergonomic handle design enables precise and fatigue-free working
- > Positive-fit joint of handle and blade for optimum transmission of force
- > Type of drive marked at end of the handle
- > Blade from GEDORE molybdenum-vanadium-Plus tempered steel



mm	mm	mm	mm	kg	Code	No.
4.0	0.8	25	81	0.031	1531174	2153 4
5.5	1.0	25	81	0.036	1482432	2153 5,5
6.5	1.2	25	81	0.039	1531182	2153 6,5
8.0	1.2	25	81	0.044	1531190	2153 8

## 2150 3C-SCREWDRIVER

for slotted head screws, special lengths

- > Acc. to DIN ISO 2380-2, blade tip acc. to DIN ISO 2380-1 Form B
  - > 3-component handles Power-Grip<sup>3</sup> with hanging hole
  - > Ergonomic handle design enables precise and fatigue-free working
  - > Positive-fit joint of handle and blade for optimum transmission of force
  - > Type of drive marked at end of the handle
  - > Blade from GEDORE molybdenum-vanadium-Plus tempered steel
- \* Length not standardised



mm	mm	mm	*	mm	Ø	kg	Code	No.
2.0	0.4	60	*	145	2,0	0.055	2822695	2150 2-60
2.5	0.4	75		160	2,5	0.055	2822709	2150 2,5-75
3.0	0.5	150	*	235	3,0	0.044	6680280	2150 3-150
3.0	0.5	200	*	285	3,0	0.055	2822717	2150 3-200
3.5	0.6	100		185	3,5	0.055	2822725	2150 3,5-100
3.5	0.6	125		210	3,5	0.055	2822733	2150 3,5-125
3.5	0.6	200	*	285	3,5	0.055	2822741	2150 3,5-200
4.0	0.8	150	*	235	4,0	0.069	6680360	2150 4-150
4.0	0.8	200	*	285	4,0	0.055	2822768	2150 4-200
4.0	0.8	300	*	385	4,0	0.055	2822776	2150 4-300
5.5	1.0	125		225	5,5	0.100	2822784	2150 5,5-125
5.5	1.0	150		250	5,5	0.104	6680520	2150 5,5-150
5.5	1.0	200	*	300	5,5	0.100	2822792	2150 5,5-200
5.5	1.0	300	*	400	5,5	0.100	2822806	2150 5,5-300
6.0	1.2	100	*	210	6,0	0.140	2822814	2150 6-100
6.5	1.2	200	*	310	6,0	0.152	6680870	2150 6,5-200

## 2160 PH 3C-SCREWDRIVER

for cross-head screws PH

- > Acc. to DIN ISO 8764, tip acc. to DIN ISO 8764-1 PH
  - > 3-component handles Power-Grip<sup>3</sup> with hanging hole
  - > Ergonomic handle design enables precise and fatigue-free working
  - > Positive-fit joint of handle and blade for optimum transmission of force
  - > Type of drive marked at end of the handle
  - > Size 3 and 4 blade with hexagon bolster
  - > Blade from GEDORE molybdenum-vanadium-Plus tempered steel
- \* not standardised



PH	M	mm	mm	kg	Code	No.
0	M1,6 - M2	60	145	0.302	6683110	2160 PH 0
0	M1,6 - M2	100	* 185	0.055	2824043	2160 PH 0-100
1	M2 - M3	80	180	0.080	6683380	2160 PH 1
1	M2 - M3	100	* 200	0.100	2824051	2160 PH 1-100
1	M2 - M3	200	300	0.166	6683700	2160 PH 1-200
2	M3,5 - M5	100	210	0.119	6683460	2160 PH 2
2	M3,5 - M5	150	* 260	0.140	2824078	2160 PH 2-150
2	M3,5 - M5	200	310	0.164	6683890	2160 PH 2-200
3	M5,5 - M7	150	270	0.192	6683540	2160 PH 3
4	M8 - M10	200	320	0.274	6683620	2160 PH 4

## 2161 PH 3C-SCREWDRIVER

for cross-head screws PH, stubby

- > Acc. to DIN ISO 8764, tip acc. to DIN ISO 8764-1 PH
- > For confined spaces
- > 3-component handles Power-Grip<sup>3</sup> with hanging hole
- > Ergonomic handle design enables precise and fatigue-free working
- > Positive-fit joint of handle and blade for optimum transmission of force
- > Type of drive marked at end of the handle
- > Blade from GEDORE molybdenum-vanadium-Plus tempered steel



PH	M	mm	mm	kg	Code	No.
1	M2 - M3	25	81	0.033	1482440	2161 PH 1
2	M3,5 - M5	25	81	0.036	1531204	2161 PH 2

## 2161 PZ 3C-SCREWDRIVER

for cross-head screws Pozi PZ, stubby

- > Acc. to DIN ISO 8764, tip acc. to DIN ISO 8764-1 PZ
- > For confined spaces
- > 3-component handles Power-Grip<sup>3</sup> with hanging hole
- > Ergonomic handle design enables precise and fatigue-free working
- > Positive-fit joint of handle and blade for optimum transmission of force
- > Type of drive marked at end of the handle
- > Blade from GEDORE molybdenum-vanadium-Plus tempered steel



PZ	M	mm	mm	kg	Code	No.
1	M2 - M3	25	81	0.032	1550608	2161 PZ 1
2	M3,5 - M5	25	81	0.037	1550616	2161 PZ 2

## 2163 K 3C-SCREWDRIVER

for in-hex screws, with ball end

- > 3-component handles Power-Grip<sup>3</sup> with hanging hole
- > Ergonomic handle design enables precise and fatigue-free working
- > Positive-fit joint of handle and blade for optimum transmission of force
- > Type of drive marked at end of the handle
- > Working angle approx. 25° in each direction
- > Blade from GEDORE molybdenum-vanadium-Plus tempered steel



mm	mm	mm	kg	Code	No.
2	100	185	0.040	1828746	2163 K 2
3	100	185	0.045	6684430	2163 K 3
4	100	185	0.068	6684510	2163 K 4
5	100	200	0.100	6684780	2163 K 5
6	125	235	0.139	6684860	2163 K 6
8	150	270	0.230	6684940	2163 K 8
10	150	270	0.285	6685080	2163 K 10
12	150	270	0.369	6685160	2163 K 12

## 2160 PZ 3C-SCREWDRIVER

for cross-head screws Pozi PZ

- > Acc. to DIN ISO 8764, tip acc. to DIN ISO 8764-1 PZ
- > 3-component handles Power-Grip<sup>3</sup> with hanging hole
- > Ergonomic handle design enables precise and fatigue-free working
- > Positive-fit joint of handle and blade for optimum transmission of force
- > Type of drive marked at end of the handle
- > Size 3 and 4 blade with hexagon bolster
- > Blade from GEDORE molybdenum-vanadium-Plus tempered steel

\* not standardised



PZ	M	mm	mm	kg	Code	No.
0	M1,6 - M2	60	145	0.038	6683970	2160 PZ 0
1	M2 - M3	80	180	0.079	6684000	2160 PZ 1
1	M2 - M3	300	* 400	0.100	2824086	2160 PZ 1-300
2	M3,5 - M5	100	210	0.119	6684190	2160 PZ 2
2	M3,5 - M5	300	* 410	0.140	2824094	2160 PZ 2-300
3	M5,5 - M7	150	270	0.189	6684270	2160 PZ 3
4	M8 - M10	200	320	0.273	6684350	2160 PZ 4

## 2163 TX 3C-SCREWDRIVER

for recessed TORX<sup>®</sup> head screws

- > 3-component handles Power-Grip<sup>3</sup> with hanging hole
- > Ergonomic handle design enables precise and fatigue-free working
- > Positive-fit joint of handle and blade for optimum transmission of force
- > Type of drive marked at end of the handle
- > Blade from GEDORE molybdenum-vanadium-Plus tempered steel
- > TORX<sup>®</sup> = reg. trademark of Acument Intellectual Properties, LLC. USA

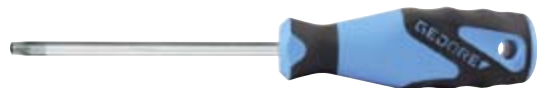

	M	mm	mm	mm	kg	Code	No.
T5	M1,8	1,42	60	145	0.037	1616471	2163 TX T5
T6	M2	1,69	60	145	0.029	6685400	2163 TX T6
T7	M2,5	1,99	60	145	0.038	6685590	2163 TX T7
T8	M2,5	2,31	60	145	0.038	6685670	2163 TX T8
T9	M3	2,50	60	145	0.038	6685750	2163 TX T9
T10	M3 - M3,5	2,74	80	165	0.039	6685830	2163 TX T10
T15	M3,5 - M4	3,27	80	165	0.054	6685910	2163 TX T15
T20	M4 - M5	3,86	100	185	0.060	6686050	2163 TX T20
T25	M4,5 - M5	4,43	100	200	0.082	6686130	2163 TX T25
T27	M4,5 - M6	4,99	115	215	0.098	6686210	2163 TX T27
T30	M6 - M7	5,52	115	225	0.123	6686480	2163 TX T30
T40	M7 - M8	6,65	130	240	0.144	6686560	2163 TX T40
T45	M8 - M10	7,82	130	250	0.176	6686640	2163 TX T45

## 2163 KTX 3C-SCREWDRIVER

for recessed TORX® screws, with ball end

- > 3-component handles Power-Grip<sup>3</sup> with hanging hole
- > Ergonomic handle design enables precise and fatigue-free working
- > Positive-fit joint of handle and blade for optimum transmission of force
- > Type of drive marked at end of the handle
- > Working angle approx. 25° in each direction
- > Blade from GEDORE molybdenum-vanadium-Plus tempered steel
- > TORX® = reg. trademark of Acument Intellectual Properties, LLC. USA



⊕	M	mm	mm	mm	kg	Code	No.
T10	M3 - M3,5	2,74	80	165	0.055	2824213	2163 KTX T10
T15	M3,5 - M4	3,27	80	165	0.055	2824221	2163 KTX T15
T20	M4 - M5	3,86	100	185	0.055	2824248	2163 KTX T20
T25	M4,5 - M5	4,43	100	200	0.100	2824256	2163 KTX T25
T27	M4,5 - M6	4,99	115	215	0.100	2824264	2163 KTX T27
T30	M6 - M7	5,52	115	225	0.140	2824272	2163 KTX T30
T40	M7 - M8	6,65	130	240	0.140	2824280	2163 KTX T40

## 2163 TXIP 3C-SCREWDRIVER

for recessed TORX PLUS® head screws

- > 3-component handles Power-Grip<sup>3</sup> with hanging hole
- > Ergonomic handle design enables precise and fatigue-free working
- > Positive-fit joint of handle and blade for optimum transmission of force
- > Type of drive marked at end of the handle
- > Blade from GEDORE molybdenum-vanadium-Plus tempered steel
- > TORX PLUS® = reg. trademark of Acument Intellectual Properties, LLC. USA

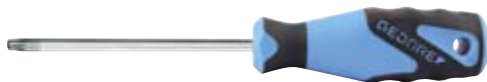

⊕	M	mm	mm	mm	kg	Code	No.
6IP	M2	2,31	60	145	0.055	2824299	2163 TX 6IP
7IP	-	-	60	145	0.055	2824302	2163 TX 7IP
8IP	M2,5 - M3	2,50	60	145	0.055	2824310	2163 TX 8IP
9IP	-	-	60	145	0.055	2824329	2163 TX 9IP
10IP	M3 - M3,5	2,74	80	165	0.055	2824337	2163 TX 10IP
15IP	M3,5 - M4	3,27	80	165	0.055	2824345	2163 TX 15IP
20IP	M4 - M5	3,86	100	185	0.055	2824353	2163 TX 20IP
25IP	M4,5 - M5	4,43	100	200	0.100	2824361	2163 TX 25IP
27IP	M5 - M6	4,99	115	215	0.100	2824388	2163 TX 27IP
30IP	M6	5,52	115	225	0.140	2824396	2163 TX 30IP
40IP	M7 - M8	6,65	130	240	0.140	2824418	2163 TX 40IP

VDE 2133

> 572



## 2163 TXB 3C-SCREWDRIVER

for recessed TORX® head screws with pilot

- > 3-component handles Power-Grip<sup>3</sup> with hanging hole
- > Ergonomic handle design enables precise and fatigue-free working
- > Positive-fit joint of handle and blade for optimum transmission of force
- > Type of drive marked at end of the handle
- > Blade from GEDORE molybdenum-vanadium-Plus tempered steel
- > TORX® = reg. trademark of Acument Intellectual Properties, LLC. USA



⊕	M	mm	mm	mm	kg	Code	No.
T7	M2,5	1,99	60	145	0.034	6677570	2163 TXB T7
T8	M2,5	2,31	60	145	0.038	6677650	2163 TXB T8
T9	M3	2,50	60	145	0.038	6677730	2163 TXB T9
T10	M3 - M3,5	2,74	80	165	0.039	6677810	2163 TXB T10
T10	M3 - M3,5	2,74	300	385	0.055	2824159	2163 TXB T10-300
T15	M3,5 - M4	3,27	80	165	0.054	6678030	2163 TXB T15
T15	M3,5 - M4	3,27	300	385	0.055	2824167	2163 TXB T15-300
T20	M4 - M5	3,86	100	185	0.060	6678110	2163 TXB T20
T20	M4 - M5	3,86	300	385	0.055	2824175	2163 TXB T20-300
T25	M4,5 - M5	4,43	100	200	0.082	6678380	2163 TXB T25
T27	M4,5 - M6	4,99	115	215	0.098	6678460	2163 TXB T27
T30	M6 - M7	5,52	115	225	0.123	6678540	2163 TXB T30
T40	M7 - M8	6,65	130	240	0.143	6678620	2163 TXB T40

## 2133 NUT DRIVER WITH 3C-HANDLE

- > Acc. to DIN 3125, ISO 2725-1
- > 3-component handles Power-Grip<sup>3</sup> with hanging hole
- > Ergonomic handle design enables precise and fatigue-free working
- > Positive-fit joint of handle and blade for optimum transmission of force
- > Head depth 25 mm, blade length 125 mm
- > 10 mm and larger with hexagon bolster
- > Blade from GEDORE molybdenum-vanadium-Plus steel

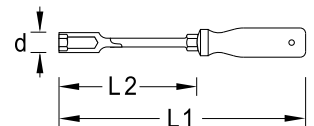

mm	L <sub>1</sub>	L <sub>2</sub>	d	∅	mm	kg	Code	No.
5.0	225	125	8,0	5	-	0.097	1746723	2133 5
5.5	225	125	8,0	5	-	0.107	1746731	2133 5,5
6.0	225	125	9,0	5	-	0.109	1746758	2133 6
7.0	235	125	11,0	6	-	0.135	1746766	2133 7
8.0	235	125	12,0	6	-	0.152	1746855	2133 8
9.0	235	125	13,0	6	-	0.168	1746863	2133 9
10.0	245	125	14,0	6	10	0.198	1746898	2133 10
11.0	245	125	16,0	8	13	0.202	1746901	2133 11
12.0	245	125	17,0	8	13	0.221	1746928	2133 12
13.0	245	125	18,0	8	13	0.225	1746944	2133 13



## 3C-SCREWDRIVER SETS

## 2150-2160 PH 3C-SCREWDRIVER SET

6 pieces / 10 pieces

- > Practical set composition in environmentally-friendly cardboard box
- > For slotted and cross-head screws PH
- > 3-component handles Power-Grip<sup>3</sup> with hanging hole
- > Ergonomic handle design enables precise and fatigue-free working
- > Positive-fit joint of handle and blade for optimum transmission of force
- > Type of drive marked at end of the handle
- > Blade from GEDORE molybdenum-vanadium-Plus tempered steel



2150-2160 PH-06

Contents		Code	No.
⊖ 2150 4 5,5 6,5 8	0.660	1482319	2150-2160 PH-06
⊕ 2160 PH 1 2			

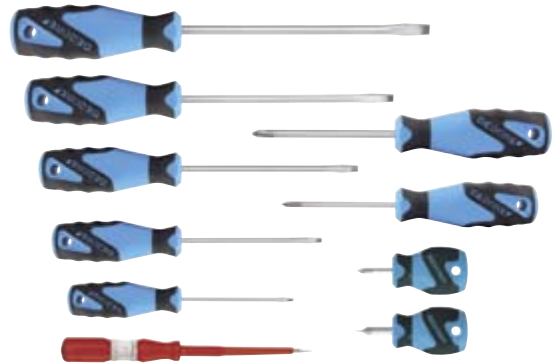

2150-2160 PH-010

Contents		Code	No.
⊖ 2150 3 4 5,5 6,5 8	0.825	1482343	2150-2160 PH-010
⊖ 2153 5,5			
⊕ 2160 PH 1 2			
⊕ 2161 PH 1			
⊖ 4615 3,5			

## 2160 PHZ-06 3C-SCREWDRIVER SET

6 pieces

- > Practical set composition in environmentally-friendly cardboard box
- > For cross-head screws PH and Pozi PZ
- > 3-component handles Power-Grip<sup>3</sup> with hanging hole
- > Ergonomic handle design enables precise and fatigue-free working
- > Positive-fit joint of handle and blade for optimum transmission of force
- > Type of drive marked at end of the handle
- > Blade from GEDORE molybdenum-vanadium-Plus tempered steel

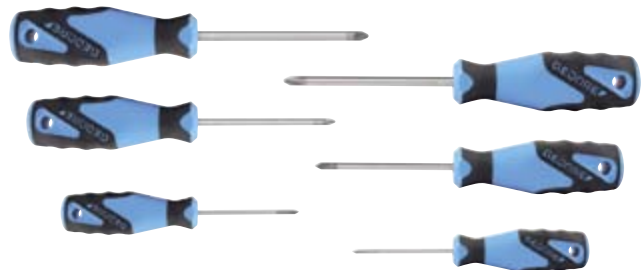

Contents		Code	No.
⊕ 2160 PH 0 1 2	0.344	2003589	2160 PHZ-06
⊕ 2160 PZ 0 1 2			

VDE 2170-2160 PH-077

&gt;579

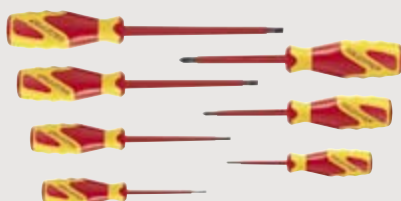

VDE 2162-2172 PM-06

&gt;577

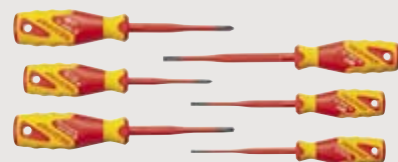

## 2150-2160 PZ-06 3C-SCREWDRIVER SET

6 pieces

- > Practical set composition in environmentally-friendly cardboard box
- > For slotted and cross-head screws Pozi PZ
- > 3-component handles Power-Grip<sup>3</sup> with hanging hole
- > Ergonomic handle design enables precise and fatigue-free working
- > Positive-fit joint of handle and blade for optimum transmission of force
- > Type of drive marked at end of the handle
- > Blade from GEDORE molybdenum-vanadium-Plus tempered steel



Contents	kg	Code	No.
⊕ 2150 4 5,5 6,5 8	0.670	1482300	2150-2160 PZ-06
⊕ 2160 PZ 1 2			

## 2163 TXB-05 3C-SCREWDRIVER SET

5 pieces

- > Practical set composition in environmentally-friendly cardboard box
- > For recessed TORX<sup>®</sup> head screws with pilot
- > 3-component handles Power-Grip<sup>3</sup> with hanging hole
- > Ergonomic handle design enables precise and fatigue-free working
- > Positive-fit joint of handle and blade for optimum transmission of force
- > Type of drive marked at end of the handle
- > Blade from GEDORE molybdenum-vanadium-Plus tempered steel
- > TORX<sup>®</sup> = reg. trademark of Acument Intellectual Properties, LLC. USA

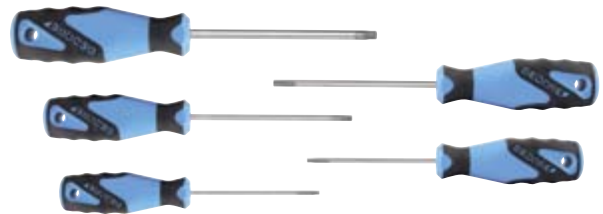

Contents	kg	Code	No.
⊕ 2163 TXB T10 T15 T20 T25 T30	0.440	1616617	2163 TXB-05

## 2163 TX 3C-SCREWDRIVER SET

5 pieces / 10 pieces

- > Practical set composition in environmentally-friendly cardboard box
- > For recessed TORX<sup>®</sup> head screws
- > 3-component handles Power-Grip<sup>3</sup> with hanging hole
- > Ergonomic handle design enables precise and fatigue-free working
- > Positive-fit joint of handle and blade for optimum transmission of force
- > Type of drive marked at end of the handle
- > Blade from GEDORE molybdenum-vanadium-Plus tempered steel
- > TORX<sup>®</sup> = reg. trademark of Acument Intellectual Properties, LLC. USA

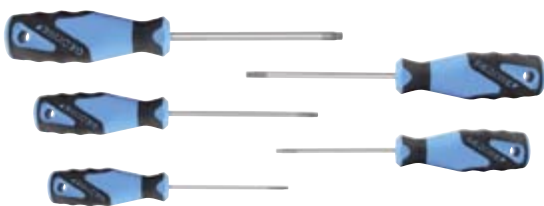

2163 TX-05

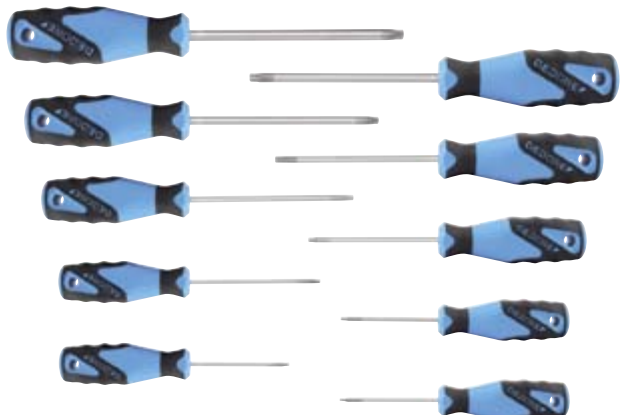

2163 TX-010

Contents	kg	Code	No.
⊕ 2163 BTX T10 T15 T20 T25 T30	0.435	1482327	2163 TX-05

Contents	kg	Code	No.
⊕ 2163 BTX T7 T8 T9 T10 T15 T20 T25 T27 T30 T40	0.740	1482335	2163 TX-010



## 3C-SCREWDRIVER WITH STRIKING CAP

### 2154SK 3C-SCREWDRIVER WITH STRIKING CAP

for slotted head screws

- > Acc. to DIN ISO 2380-2, blade tip acc. to DIN ISO 2380-1 Form A
- > 3-component handles Power-Grip<sup>3</sup> with striking cap
- > Ergonomic handle design enables precise and fatigue-free working
- > Positive-fit joint of handle and blade for optimum transmission of force
- > Hexagon blade with additional hexagon bolster
- > Blade from GEDORE molybdenum-vanadium-Plus tempered steel
- \* Length not standardised



⊖ mm	mm	mm	mm	mm	kg	Code	No.
3.5	0.6	75	180	8	0.086	1845209	2154SK 3,5
4.5	0.8	75	* 180	8	0.090	1845217	2154SK 4,5
5.5	1.0	100	205	8	0.092	1845225	2154SK 5,5
6.5	1.2	125	230	10	0.154	1845233	2154SK 6,5
6.5	1.2	150	255	10	0.229	2824108	2154SK 6,5-150
7.0	1.2	125	230	10	0.229	2824116	2154SK 7
8.0	1.2	150	270	13	0.178	1845241	2154SK 8
8.0	1.6	175	295	13	0.229	2824124	2154SK 8-175
10.0	1.6	200	320	13	0.214	1845268	2154SK 10
10.0	1.6	300	420	13	0.229	2824132	2154SK 10-300
12.0	2.0	200	320	16	0.260	1845276	2154SK 12
12.0	2.0	250	370	16	0.229	2824140	2154SK 12-250
14.0	2.5	250	370	16	0.324	1845284	2154SK 14

### 2160SK PZ 3C-SCREWDRIVER WITH STRIKING CAP

for cross-head screws Pozi PZ

- > Acc. to DIN ISO 8764, tip acc. to DIN ISO 8764-1 PZ
- > 3-component handles Power-Grip<sup>3</sup> with striking cap
- > Ergonomic handle design enables precise and fatigue-free working
- > Positive-fit joint of handle and blade for optimum transmission of force
- > Hexagon blade with additional hexagon bolster
- > Blade from GEDORE molybdenum-vanadium-Plus tempered steel



⊕ PZ	M	mm	mm	mm	kg	Code	No.
1	M2 - M3	80	185	8	0.086	1845330	2160SK PZ 1
2	M3,5 - M5	100	205	10	0.148	1845349	2160SK PZ 2
3	M5,5 - M7	150	270	13	0.206	1845357	2160SK PZ 3

### 2160SK PH 3C-SCREWDRIVER WITH STRIKING CAP

for cross-head screws PH

- > Acc. to DIN ISO 8764, tip acc. to DIN ISO 8764-1 PH
- > 3-component handles Power-Grip<sup>3</sup> with striking cap
- > Ergonomic handle design enables precise and fatigue-free working
- > Positive-fit joint of handle and blade for optimum transmission of force
- > Hexagon blade with additional hexagon bolster
- > Blade from GEDORE molybdenum-vanadium-Plus tempered steel



⊕ PH	M	mm	mm	mm	kg	Code	No.
1	M2 - M3	80	185	8	0.086	1845292	2160SK PH 1
2	M3,5 - M5	100	205	10	0.148	1845306	2160SK PH 2
3	M5,5 - M7	150	270	13	0.204	1845314	2160SK PH 3
4	M8 - M10	200	320	16	0.292	1845322	2160SK PH 4

### SK 2154 PH-06 3C-SCREWDRIVER SET WITH STRIKING CAP

6 pieces

- > Practical set composition in environmentally-friendly cardboard box
- > For firmly seated slotted and cross-head screws PH
- > Hexagon blade with additional hexagon bolster
- > 3-component handles Power-Grip<sup>3</sup> with striking cap
- > Ergonomic handle design enables precise and fatigue-free working
- > Positive-fit joint of handle and blade for optimum transmission of force
- > Blade from GEDORE molybdenum-vanadium-Plus tempered steel



Contents	kg	Code	No.
⊖ 2154SK 4,5 5,5 6,5 8	0.880	1878743	SK 2154 PH-06
⊕ 2160SK PH 1 2			



## SCREWDRIVER WITH WOODEN HANDLE

### 147 SCREWDRIVER

for slotted head screws

- > Similar to DIN ISO 2380-2 Row B+C, blade tip acc. to DIN ISO 2380-1 Form A
- > Blade tanged right through the handle, chrome-plated
- > GEDORE vanadium steel 50CrV4
- > Hardwood handle, clear varnished with leather cap
- > Hexagon bolster for higher transmission of force



mm	mm	mm	mm	mm	kg	Code	No.
3.5	0.6	75	170	6	0.055	6413830	147 3,5
4.5	0.8	90	185	6	0.059	6413910	147 4,5
5.5	1.0	100	200	8	0.073	6414050	147 5,5
7.0	1.2	125	235	10	0.112	6414130	147 7
9.0	1.4	150	270	12	0.166	6414210	147 9
10.0	1.6	175	300	12	0.192	6414480	147 10
12.0	2.0	200	330	13	0.250	6414560	147 12

### 148 SCREWDRIVER

for slotted head screws

- > Similar to DIN ISO 2380-2 Row B+C, blade tip acc. to DIN ISO 2380-1 Form A
- > Hexagon blade with forged bolster for higher transmission of force
- > Blade tanged right through the handle, chrome-plated
- > GEDORE vanadium steel 50CrV4
- > Hardwood handle, clear varnished with leather cap



mm	mm	mm	mm	mm	kg	Code	No.
5.5	0.8	100	200	6	0.083	6415020	148 5,5
7.0	1.0	125	230	7	0.123	6415100	148 7
8.0	1.2	150	270	8	0.174	6415290	148 8
10.0	1.6	175	300	8	0.233	6415370	148 10
12.0	2.0	200	330	12	0.381	6415450	148 12
14.0	2.5	250	390	12	0.478	6415530	148 14

### 162 SCREWDRIVER

for cross-head screws PH

- > Similar to DIN ISO 8764-2, tip acc. to DIN ISO 8764-1 PH
- > Blade tanged right through the handle, chrome-plated
- > GEDORE vanadium steel 50CrV4
- > Hardwood handle, clear varnished with leather cap
- > Hexagon bolster for higher transmission of force



PH	M	mm	mm	mm	kg	Code	No.
1	M 2 - M 3	80	180	6	0.058	6429400	162 1
2	M 3,5 - M 5	100	210	10	0.096	6429590	162 2
3	M 6	150	275	12	0.172	6429670	162 3
4	M 8 - M 10	200	340	17	0.325	6429750	162 4

### 147-04 SCREWDRIVER SET

4 pieces

- > Work-orientated assortment packed in environmentally-friendly cardboard box
- > For slotted head screws
- > Blade tanged right through the handle, chrome-plated
- > GEDORE vanadium steel 50CrV4
- > Hardwood handle, clear varnished with leather cap
- > Hexagon bolster for higher transmission of force



Contents	kg	Code	No.
147 5,5 7 9 10	0.585	6422820	147-04

### 147-162-05 SCREWDRIVER SET

5 pieces

- > Work-orientated assortment packed in environmentally-friendly cardboard box
- > For slotted head and cross-head screws PH
- > Blade tanged right through the handle, chrome-plated
- > GEDORE vanadium steel 50CrV4
- > Hardwood handle, clear varnished with leather cap
- > Hexagon bolster for higher transmission of force



Contents	kg	Code	No.
147 5,5 7 9	0.535	6423120	147-162-05
162 1 2			

## ELECTRONIC SCREWDRIVER

## 171 IS ELECTRONIC SCREWDRIVER

for slotted head screws

- › Blade in high-alloy chrome-vanadium-molybdenum steel, chrome-plated
- › Tip additionally coated for highest precision and corrosion protection
- › 2-component-handle in ergonomic design
- › Pivoting end cap with micro anti-slip surface
- › Colour coding of the drive type



mm	mm	mm	Ø	kg	Code	No.
1.2	60	155	2,5	0.017	1845004	171 IS 1,2
1.5	60	155	2,5	0.014	6436450	171 IS 1,5
1.8	60	155	2,5	0.017	1845012	171 IS 1,8
2.0	60	155	2,5	0.017	6438660	171 IS 2
2.5	75	170	2,5	0.020	1845020	171 IS 2,5
3.0	100	195	3,0	0.023	1845039	171 IS 3

## 165 PH ELECTRONIC SCREWDRIVER

for cross-head screws PH

- › Blade in high-alloy chrome-vanadium-molybdenum steel, chrome-plated
- › Tip additionally coated for highest precision and corrosion protection
- › 2-component-handle in ergonomic design
- › Pivoting end cap with micro anti-slip surface
- › Colour coding of the drive type



PH	M	mm	mm	Ø	kg	Code	No.
000		60	155	2,5	0.018	1845047	165 PH 000
00		60	155	2,5	0.016	6442770	165 PH 00
0	M1,6 - M2	60	155	3,0	0.018	6442930	165 PH 0
1	M2-M3	80	175	4,5	0.031	1845055	165 PH 1

## 165 TX ELECTRONIC SCREWDRIVER

for recessed TORX® head screws

- › Blade in high-alloy chrome-vanadium-molybdenum steel, chrome-plated
- › Tip additionally coated for highest precision and corrosion protection
- › 2-component-handle in ergonomic design
- › Pivoting end cap with micro anti-slip surface
- › Colour coding of the drive type
- › TORX® = reg. trademark of Acument Intellectual Properties, LLC. USA



T	M	mm	mm	mm	Ø	kg	Code	No.
T3	M1,2 - M1,4	1,13	60	155	2,5	0.016	1845098	165 TX T3
T4	M1,4	1,29	60	155	2,5	0.016	1845101	165 TX T4
T5	M1,8	1,42	60	155	2,5	0.017	1845128	165 TX T5
T6	M2	1,69	60	155	3,0	0.019	1845136	165 TX T6
T7	M2,5	1,99	60	155	3,0	0.019	1845144	165 TX T7
T8	M2,5	2,31	60	155	3,0	0.019	1845152	165 TX T8
T9	M3	2,50	60	155	3,0	0.019	1845160	165 TX T9
T10	M3 - M3,5	2,74	60	155	3,0	0.020	1845179	165 TX T10
T15	M3,5 - M4	3,27	60	155	3,5	0.023	1845187	165 TX T15
T20	M4 - M5	3,86	80	175	4,0	0.029	1845195	165 TX T20

## 164 IN ELECTRONIC SCREWDRIVER

for in-hex screws

- › Blade in high-alloy chrome-vanadium-molybdenum steel, chrome-plated
- › Tip additionally coated for highest precision and corrosion protection
- › 2-component-handle in ergonomic design
- › Pivoting end cap with micro anti-slip surface
- › Colour coding of the drive type



mm	mm	mm	Ø	kg	Code	No.
0,7	60	155	2,5	0.018	1845063	164 IN 0,7
0,9	60	155	2,5	0.018	1845071	164 IN 0,9
1,3	60	155	2,5	0.017	6443150	164 IN 1,3
1,5	60	155	2,5	0.017	6443230	164 IN 1,5
2	60	155	2,5	0.019	6443310	164 IN 2
2,5	60	155	3,0	0.016	6443580	164 IN 2,5
3	60	155	3,5	0.022	6443740	164 IN 3

## 165-171-06

### ELECTRONIC SCREWDRIVER SET

6 pieces

- > For slotted head and cross-head screws PH
- > Blade in high-alloy chrome-vanadium-molybdenum steel, chrome-plated
- > Tip additionally coated for highest precision and corrosion protection
- > 2-component-handle in ergonomic design
- > Pivoting end cap with micro anti-slip surface
- > Colour coding of the drive type
- > In plastic case
- > With GEDORE Check-Tool-System: 2-colour foam insert to check that the set is complete



## 165 TX-06

### ELECTRONIC SCREWDRIVER SET

6 pieces

- > For recessed TORX® head screws
- > Blade in high-alloy chrome-vanadium-molybdenum steel, chrome-plated
- > Tip additionally coated for highest precision and corrosion protection
- > 2-component-handle in ergonomic design
- > Pivoting end cap with micro anti-slip surface
- > Colour coding of the drive type
- > In plastic case
- > With GEDORE Check-Tool-System: 2-colour foam insert to check that the set is complete
- > TORX® = reg. trademark of Acument Intellectual Properties, LLC. USA



Contents		Code	No.
⊕ 165 PH 000 00 0	0.385	1902849	165-171-06
⊖ 171 IS 1,2 1,8 2,5			

Contents		Code	No.
⊕ 165 TX T5 T6 T7 T8 T9 T10	0.415	1902857	165 TX-06

## 1021

### ELECTRONIC SCREWDRIVER SET

7 pieces

- > In plastic case
- > Dimensions: 275 x 150 x 42 mm

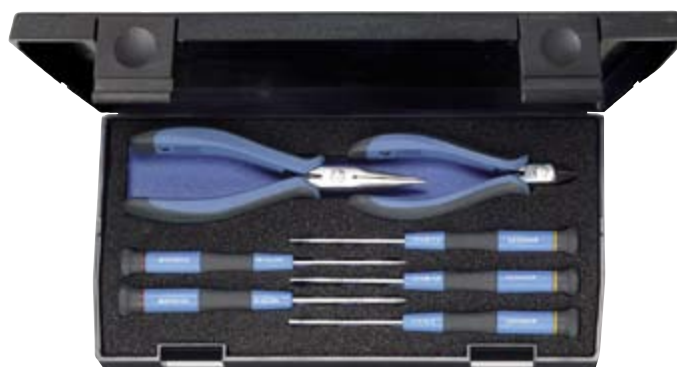

Contents		Code	No.
⊖ 171 IS 1,2 1,5 2	0.624	6601830	1021
⊕ 165 PH 00 0			
8305-2			
8306-5			



## 2GT-HANDLE

> 2-component wing handle for high torque level when loosening or tightening. The lengthened wing provides an optimum contact surface for the palm of one's hand. It thus easily transfers considerable forces in a relaxed hand's position.

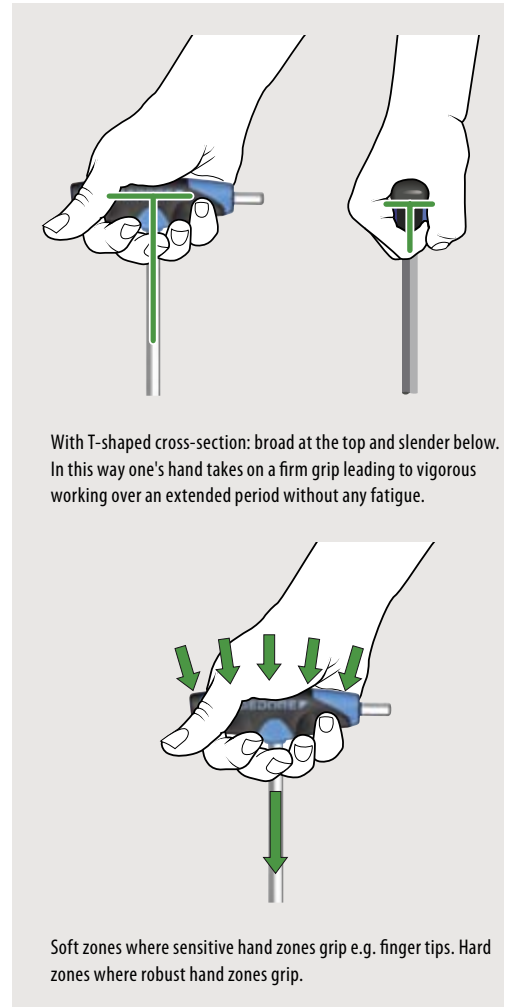
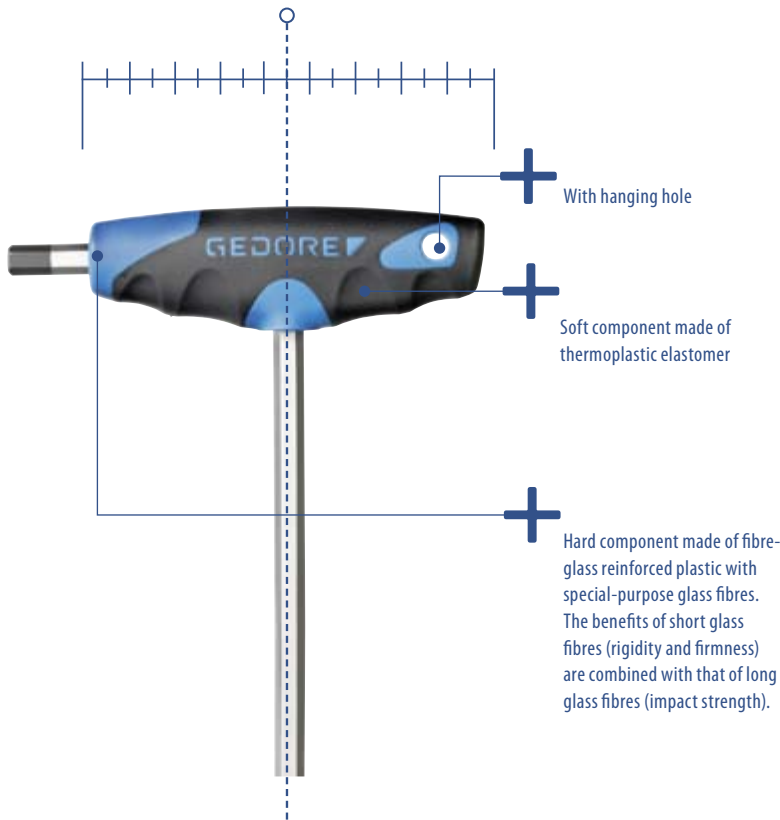

### 2142 T (MM) HEXAGON ALLEN KEY WITH 2GT-HANDLE

for in-hex screws

- > With hanging hole
- > GEDORE vanadium steel 61CrSIV5, chromated

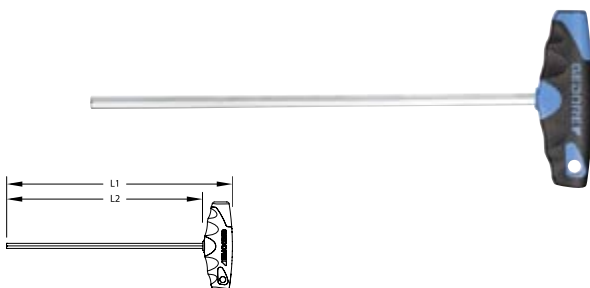

● mm	L <sub>1</sub>	L <sub>2</sub>	⚖	Code	No.
2	152	125	0.061	2647257	2142T2
2,5	152	125	0.091	2647265	2142T2,5
3	152	125	0.071	2647273	2142T3
4	152	125	0.080	2647281	2142T4
5	177	150	0.100	2647303	2142T5
6	188	150	0.140	2647311	2142T6
7	213	175	0.160	2681439	2142T7
8	213	175	0.221	2647338	2142T8
10	238	200	0.201	2647346	2142T10

### 2142 T (AF) HEXAGON ALLEN KEY WITH 2GT-HANDLE

for in-hex screws

- > With hanging hole
- > GEDORE vanadium steel 61CrSIV5, chromated

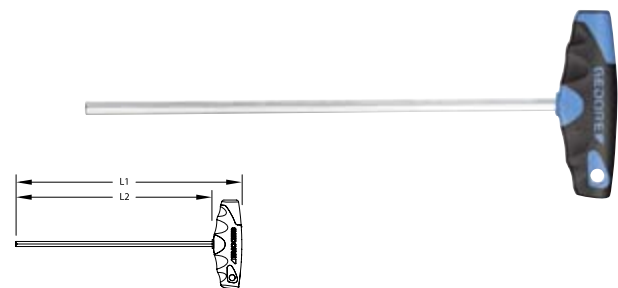

● AF	L <sub>1</sub>	L <sub>2</sub>	⚖	Code	No.
1/8	152	125	0.101	2647354	2142T1/8AF
5/32	152	125	0.121	2647362	2142T5/32AF
3/16	177	150	0.100	2647370	2142T3/16AF
1/4	213	175	0.140	2647389	2142T1/4AF
5/16	213	175	0.221	2647397	2142T5/16AF
3/8	238	200	0.201	2647400	2142T3/8AF

## DT 2142

### HEXAGON ALLEN KEY WITH 2CT-HANDLE

for in-hex screws

- > With hanging hole
- > With 2 hexagons, same size each end
- > GEDORE vanadium steel 61CrSiV5, chromated

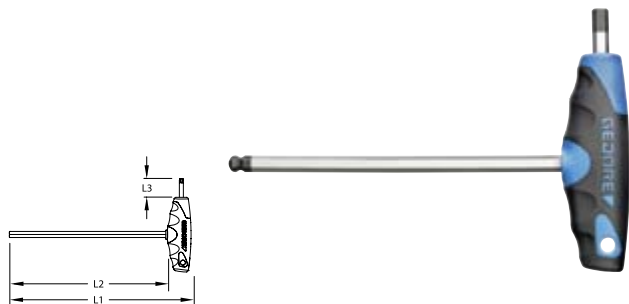

mm	L <sub>1</sub>	L <sub>2</sub>	L <sub>3</sub>	g	Code	No.
2	152	125	15	0.091	2488914	DT 2142 2
2,5	152	125	15	0.071	2498596	DT 2142 2,5
3	152	125	15	0.040	2498618	DT 2142 3
4	152	125	15	0.080	2498626	DT 2142 4
5	177	150	20	0.100	2502631	DT 2142 5
6	188	150	20	0.120	2502658	DT 2142 6
7	213	175	25	0.251	2505487	DT 2142 7
8	213	175	25	0.180	2507447	DT 2142 8
10	238	200	25	0.280	2507471	DT 2142 10

## 2142 TX

### WRENCH KEY WITH 2CT-HANDLE

for recessed TORX® screws

- > With hanging hole
- > Chrome-vanadium steel, blade chrome-plated, tip gun-metal finish
- > TORX® = reg. trademark of Acument Intellectual Properties, LLC. USA

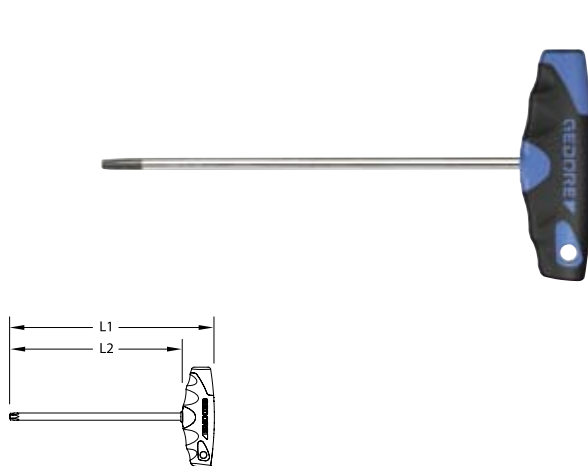

mm	M	mm	L <sub>1</sub>	L <sub>2</sub>	g	Code	No.
T5	M1,8	1,42	152	125	0.081	2509393	2142 TX T5
T6	M2	1,70	152	125	0.081	2511622	2142 TX T6
T7	M2,5	1,99	152	125	0.081	2511657	2142 TX T7
T8	M2,5	2,31	152	125	0.051	2513072	2142 TX T8
T9	M3	2,50	152	125	0.071	2513102	2142 TX T9
T10	M3 - M3,5	2,74	152	125	0.061	2513749	2142 TX T10
T15	M3,5 - M4	3,27	152	125	0.091	2516934	2142 TX T15
T20	M4 - M5	3,86	152	125	0.081	2519062	2142 TX T20
T25	M4,5 - M5	4,43	177	150	0.091	2519186	2142 TX T25
T27	M4,5 - M6	4,99	177	150	0.100	2521571	2142 TX T27
T30	M6 - M7	5,52	188	150	0.100	2521598	2142 TX T30
T40	M7 - M8	6,65	213	175	0.140	2521601	2142 TX T40
T45	M8 - M10	7,82	213	175	0.160	2521636	2142 TX T45
T50	M10	8,83	238	200	0.180	2521644	2142 TX T50

1500 CT2-DT 2142



>110

## DT 2143 KTX

### CRANKED SOCKET KEY WITH 2CT-HANDLE

for recessed TORX® screws

- > Working angle approx. 25°
- > With hanging hole
- > Chrome-vanadium steel, blades chrome-plated, tip phosphated
- > TORX® = reg. trademark of Acument Intellectual Properties, LLC. USA

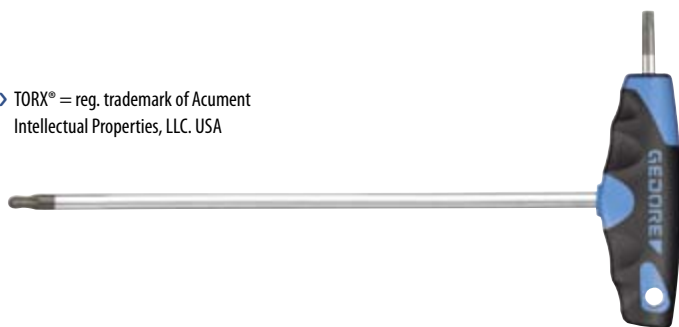
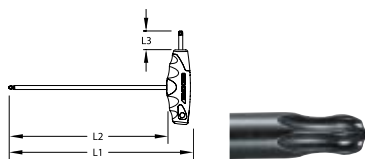

mm	M	mm	L <sub>1</sub>	L <sub>2</sub>	L <sub>3</sub>	g	Code	No.
T10	M3 - M3,5	2,74	152	125	15	0.091	2647486	DT 2143 KTX T10
T15	M3,5 - M4	3,27	152	125	15	0.081	2647494	DT 2143 KTX T15
T20	M4 - M5	3,86	152	125	15	0.071	2647508	DT 2143 KTX T20
T25	M4,5 - M5	4,43	177	150	20	0.121	2647516	DT 2143 KTX T25
T27	M4,5 - M6	4,99	177	150	20	0.120	2647524	DT 2143 KTX T27
T30	M6 - M7	5,52	188	150	25	0.140	2647532	DT 2143 KTX T30
T40	M7 - M8	6,65	213	175	25	0.180	2647540	DT 2143 KTX T40

## 2133 T NUT DRIVER WITH 2GT-HANDLE

- > With hanging hole
- > Head depth 25 mm
- > GEDORE vanadium steel 31CrV3, matt chrome-plated

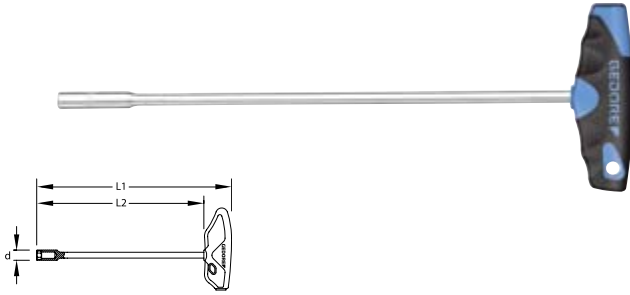

Ø mm	L <sub>1</sub>	L <sub>2</sub>	d		Code	No.
5.5	257	230	8	0.101	2647621	2133 T 5,5
6.0	257	230	9	0.101	2647648	2133 T 6
7.0	268	230	11	0.101	2647656	2133 T 7
8.0	268	230	12	0.180	2647664	2133 T 8
9.0	268	230	13	0.180	2647672	2133 T 9
10.0	268	230	14	0.180	2647680	2133 T 10
11.0	268	230	16	0.200	2647699	2133 T 11
12.0	268	230	17	0.220	2647702	2133 T 12
13.0	268	230	18	0.240	2647710	2133 T 13

## 42 DKEL - THE FIRST WITH TWO BALL ENDS

- > Two ball ends and an extra short angle side for working optimally in confined spaces
- > Positive or negative inclination produces a possible 50° angle of approach (+/- 25°) to the screw axis
- > Projecting hindrances can be got round with the two ball ends - rapid work is the outcome
- > The GEDORE vanadium steel 59CRV4 with its high manganese share ensures the screwdriver has that strength needed

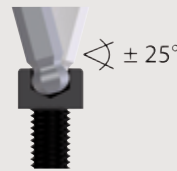
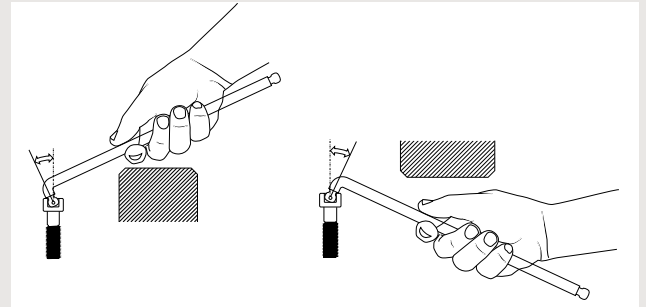

## DTT 42 HEXAGON ALLEN KEY

for in-hex screws

- > With 3 hexagons, same size each end
- > T-handle fixed



Ø mm	L <sub>1</sub>	L <sub>2</sub>	L <sub>3</sub>	Ø		Code	No.
3	150	75	30	5.0	0.042	1669540	DTT 42 3
4	180	90	35	6.0	0.064	1669559	DTT 42 4
5	180	90	35	7.0	0.092	1669567	DTT 42 5
6	210	105	40	8.0	0.134	1669575	DTT 42 6
8	250	125	50	9.5	0.224	1669583	DTT 42 8
10	300	150	60	12.0	0.418	1669591	DTT 42 10

## H 42 DKEL-88 HEXAGON ALLEN KEY SET

for in-hex screws, extra long, with double ball end

- > Particularly suitable for confined spaces in view of a double ball end and short angled side
- > Easy to use where normal hexagon allen keys would fail thanks to improved accessibility and a low profile
- > Rapid progress in work since the two ball ends allow protrusions to be gone round
- > Reduces the risk of injury to the fingers when working on flat surfaces
- > GEDORE vanadium steel 59CrV4, zinc-plated



Contents		Code	No.
● mm 42 DKEL 2 2,5 3 4 5 6 8 10	0.400	2797186	H 42 DKEL-88



## 42 DKEL HEXAGON ALLEN KEY

for in-hex screws, extra long, with double ball end

- > Particularly suitable for confined spaces in view of a double ball end and short angled side
- > Easy to use where normal hexagon allen keys would fail thanks to improved accessibility and a low profile
- > Rapid progress in work since the two ball ends allow protrusions to be gone round
- > Reduces the risk of injury to the fingers when working on flat surfaces
- > GEDORE vanadium steel 59CrV4, zinc-plated



mm	L <sub>1</sub>	L <sub>2</sub>	kg	Code	No.
1,5	89	7.5	0.003	2797062	42 DKEL 1,5
2	102	9.0	0.004	2797089	42 DKEL 2
2,5	115	10.0	0.006	2797097	42 DKEL 2,5
3	129	11.5	0.010	2797100	42 DKEL 3
4	144	14.5	0.018	2797119	42 DKEL 4
5	165	16.5	0.050	2797127	42 DKEL 5
6	186	19.0	0.060	2797135	42 DKEL 6
7	197	20.5	0.070	2797143	42 DKEL 7
8	205	22.0	0.090	2797151	42 DKEL 8
10	227	28.0	0.160	2797178	42 DKEL 10

## H 42 KEL-88 HEXAGON ALLEN KEY SET

for in-hex screws, extra long, with ball end

- > In blue plastic holder (LPDE)
- > GEDORE vanadium steel 59CrV4, chromated



Contents	kg	Code	No.
mm 42 KEL 2 2,5 3 4 5 6 8 10	0.415	1523988	H 42 KEL-88

## H 42 EL-88 HEXAGON ALLEN KEY SET

for in-hex screws, extra long

- > In blue plastic holder (LPDE)
- > Acc. to DIN ISO 2936
- > GEDORE vanadium steel 61CrSiV5, zinc-plated

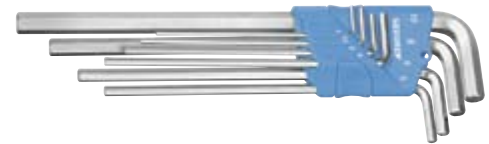

Contents	kg	Code	No.
mm 42 EL 2 2,5 3 4 5 6 8 10	0.425	1505416	H 42 EL-88

## 42 KEL HEXAGON ALLEN KEY

for in-hex screws, extra long, with ball end

- > GEDORE vanadium steel 59CrV4, chrome-plated



mm	L <sub>1</sub>	L <sub>2</sub>	kg	Code	No.
1,5	91.5	15.5	0.003	1563556	42 KEL 1,5
2	102.0	18.0	0.004	6370090	42 KEL 2
2,5	114.5	20.5	0.006	6370170	42 KEL 2,5
3	129.0	23.0	0.010	6370250	42 KEL 3
4	144.0	29.0	0.019	6370330	42 KEL 4
5	165.0	33.0	0.033	6370410	42 KEL 5
6	186.0	38.0	0.053	6370680	42 KEL 6
7	197.0	41.0	0.076	1729241	42 KEL 7
8	208.0	44.0	0.103	6370760	42 KEL 8
10	234.0	50.0	0.179	6370840	42 KEL 10
12	262.0	57.0	0.287	6370920	42 KEL 12

## H 42 EL-88 A HEXAGON ALLEN KEY SET

for in-hex screws, extra long

- > In blue plastic holder (LPDE)
- > GEDORE vanadium steel 61CrSiV5, zinc-plated

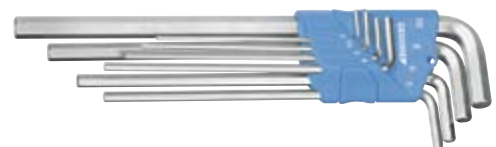

Contents	kg	Code	No.
AF 42 EL 5/64 3/32 1/8 5/32 3/16 7/32 1/4 5/16"	0.300	1543555	H 42 EL-88 A



## 42 EL (MM) HEXAGON ALLEN KEY

for in-hex screws, extra long

- > Acc. to DIN ISO 2936
- > GEDORE vanadium steel 61CrSiV5, zinc-plated

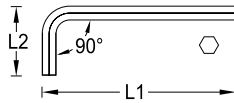

● mm	L <sub>1</sub>	L <sub>2</sub>	⚖	Code	No.
2	102.0	18.0	0.004	6350810	42 EL 2 (5/64AF)
2,5	114.5	20.5	0.007	6351030	42 EL 2,5
3	129.0	23.0	0.010	6351110	42 EL 3
4	144.0	29.0	0.019	6351380	42 EL 4
5	165.0	33.0	0.033	6351460	42 EL 5
5,5	186.0	38.0	0.047	1543342	42 EL 7/32AF (5,5MM)
6	186.0	38.0	0.054	6351540	42 EL 6
7	194.0	41.0	0.750	2977486	42 EL 7
8	208.0	44.0	0.104	6351620	42 EL 8
10	234.0	50.0	0.184	6351700	42 EL 10
12	262.0	57.0	0.293	6351890	42 EL 12
14	294.0	70.0	0.453	6351970	42 EL 14

## 42 EL (AF) HEXAGON ALLEN KEY

for in-hex screws, extra long

- > GEDORE vanadium steel 61CrSiV5, zinc-plated

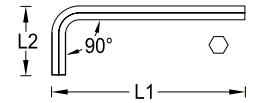

● AF	L <sub>1</sub>	L <sub>2</sub>	⚖	Code	No.
5/64	102.0	18.0	0.004	6350810	42 EL 2 (5/64AF)
3/32	114.5	20.5	0.006	1543377	42 EL 3/32AF
1/8	129.0	23.0	0.011	1543318	42 EL 1/8AF
5/32	144.0	29.0	0.019	1543326	42 EL 5/32AF
3/16	165.0	33.0	0.030	1543334	42 EL 3/16AF
7/32	186.0	38.0	0.047	1543342	42 EL 7/32AF (5,5MM)
1/4	197.0	41.0	0.065	1543369	42 EL 1/4AF
5/16	208.0	44.0	0.103	1543350	42 EL 5/16AF
3/8	234.0	50.0	0.167	1543385	42 EL 3/8AF
1/2	277.0	63.0	0.355	1543393	42 EL 1/2AF
9/16	294.0	70.0	0.475	1543407	42 EL 9/16AF

## PH 42-88 HEXAGON ALLEN KEY SET

for in-hex screws

- > In blue plastic holder
- > GEDORE vanadium steel 61CrSiV5, zinc-plated



Contents	⚖	Code	No.
● mm 42 2 2,5 3 4 5 6 8 10	0.245	6352000	PH 42-88

## H 42-10 HEXAGON ALLEN KEY SET

for in-hex screws

- > In blue plastic holder (LPDE)
- > Acc. to DIN ISO 2936
- > GEDORE vanadium steel 61CrSiV5, zinc-plated



Contents	⚖	Code	No.
● mm 42 1,3 1,5 2 2,5 3 4 5 6 8 10	0.259	1505408	H 42-10

# 42 (MM) HEXAGON ALLEN KEY SET

for in-hex screws

- > In blue PVC wallet
- > GEDORE vanadium steel 61CrSiV5, zinc-plated



Contents		Code	No.
<b>mm 42 2 2,5 3 4 5 6 8</b>	0.144	6347510	42-07
<b>mm 42 2,5 3 4 5 6 8 10</b>	0.254	6349050	42-70

Contents		Code	No.
<b>mm 42 3 4 5 6 8 10 12 14</b>	0.716	6347780	42-08
<b>mm 42 2 2,5 3 4 5 6 7 8 10</b>	0.297	6347860	42-09

# 42 (MM) HEXAGON ALLEN KEY

for in-hex screws

- > Acc. to DIN ISO 2936
- > GEDORE vanadium steel 61CrSiV5, sizes 0.7 mm and 0.9 mm gun-metal finish, zinc-plated up to size 12 mm, chrome-plated up from size 14 mm
- \* not standardised

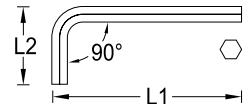

mm	L <sub>1</sub>	L <sub>2</sub>		Code	No.
0,7	33.0	7.0	0.001	6342200	42 0,7
0,9	33.0	11.0	0.001	6342390	42 0,9
1,3	41.0	13.0	0.001	6342470	42 1,3
1,5	46.5	15.5	0.001	6340260	42 1,5
2	52.0	18.0	0.002	6340340	42 2 (5/64AF)
2,5	58.5	20.5	0.004	6340420	42 2,5
3	66.0	23.0	0.006	6340500	42 3
4	74.0	29.0	0.011	6340690	42 4
5	85.0	33.0	0.019	6340770	42 5
5,5	*	82.0	0.022	6344840	42 7/32AF (5,5MM)
6		96.0	0.031	6340850	42 6
7	*	102.0	0.044	6340930	42 7

mm	L <sub>1</sub>	L <sub>2</sub>		Code	No.	
8	108.0	44.0	0.061	6341070	42 8	
9	*	114.0	47.0	0.081	6341150	42 9
10	122.0	50.0	0.106	6341230	42 10	
12	137.0	57.0	0.169	6341310	42 12	
14	154.0	70.0	0.266	6341580	42 14	
17	177.0	80.0	0.430	6341660	42 17	
19	199.0	89.0	0.602	6341740	42 19	
22	222.0	102.0	0.907	6341820	42 22	
24	248.0	114.0	1.211	6341900	42 24	
27	277.0	127.0	1.711	6342550	42 27	
30	315.0	142.0	2.423	6342630	42 30	
32	347.0	157.0	3.010	6342710	42 32	

# H 42-88 A HEXAGON ALLEN KEY SET

for in-hex screws

- > In blue plastic holder (LPDE)
- > GEDORE vanadium steel 61CrSiV5, zinc-plated

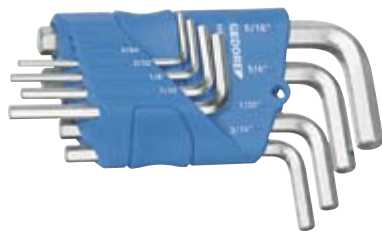

Contents		Code	No.
<b>"AF 42 5/64 3/32 1/8 5/32 3/16 7/32 1/4 5/16"</b>	0.172	1505424	H 42-88 A

# 42 (AF) HEXAGON ALLEN KEY SET

for in-hex screws

- > In blue PVC wallet
- > GEDORE vanadium steel 61CrSiV5, zinc-plated



Contents		Code	No.
<b>"AF 5/64 3/32 1/8 5/32 3/16 7/32 1/4"</b>	0.103	6348750	42-07 A
<b>"AF 1/8 5/32 3/16 1/4 5/16 3/8 1/2 9/16"</b>	0.731	6348830	42-08 A
<b>"AF 5/64 3/32 1/8 5/32 3/16 7/32 1/4 5/16 3/8"</b>	0.257	6348910	42-09 A

## 42 (AF) HEXAGON ALLEN KEY

for in-hex screws

> GEDORE vanadium steel 61CrSiV5, zinc-plated up to size 1/2", chrome-plated up from size 9/16"

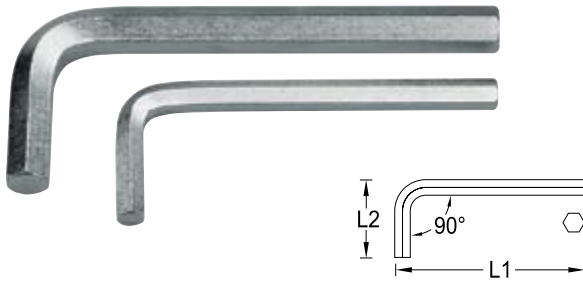

● "AF	L <sub>1</sub>	L <sub>2</sub>	⚖ kg	Code	No.
3/64	41.0	13.0	0.002	6342120	42 3/64AF
1/16	46.5	15.5	0.002	6342040	42 1/16AF
3/32	56.5	20.5	0.004	6344330	42 3/32AF
5/64	52.0	18.0	0.002	6340340	42 2 (5/64AF)
1/8	60.0	23.0	0.006	6344410	42 1/8AF
5/32	67.0	26.0	0.010	6344680	42 5/32AF
3/16	73.0	30.0	0.015	6344760	42 3/16AF
7/32	82.0	32.0	0.022	6344840	42 7/32AF (5,5MM)
1/4	92.0	36.5	0.035	6344920	42 1/4AF
5/16	102.0	43.0	0.059	6345060	42 5/16AF
3/8	115.0	49.0	0.094	6345140	42 3/8AF
1/2	142.0	61.0	0.205	6345220	42 1/2AF
9/16	154.0	66.0	0.274	6345300	42 9/16AF
5/8	168.0	76.0	0.376	6345490	42 5/8AF
3/4	199.0	89.0	0.309	6345570	42 3/4AF

## 42 Z HEXAGON ALLEN KEY

with pilot, for in-hex screws

> Acc. to DIN 6911

> Chrome-vanadium steel, zinc-plated

\* not standardised

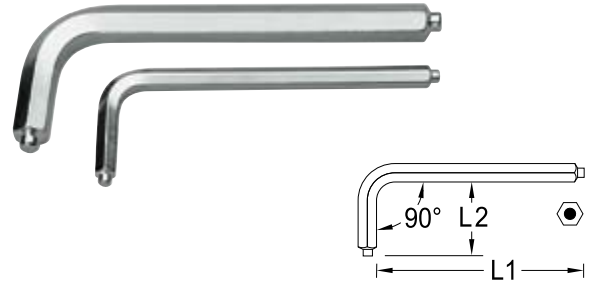

● mm	L <sub>1</sub>	L <sub>2</sub>	⚖ kg	Code	No.
3	63	20	0.006	6342980	42 Z 3
4	70	25	0.010	6343010	42 Z 4
5	80	28	0.019	6343280	42 Z 5
6	90	32	0.031	6343360	42 Z 6
7	*	34	0.042	6343440	42 Z 7
8	100	36	0.058	6343520	42 Z 8
10	112	40	0.100	6343600	42 Z 10
12	125	45	0.162	6343790	42 Z 12
14	140	56	0.254	6343870	42 Z 14
17	160	63	0.418	6343950	42 Z 17
19	180	70	0.584	6344090	42 Z 19

## S 42-09 A HEXAGON ALLEN KEY SET

for in-hex screws

> On key ring with quick release

> GEDORE vanadium steel 61CrSiV5, zinc-plated



Contents	⚖ kg	Code	No.
● "AF 42 5/64 3/32 1/8 5/32 3/16 7/32 1/4 5/16 3/8"	0.273	6348160	S 42-09 A

## S 42-07 HEXAGON ALLEN KEY SET

for in-hex screws

> On key ring with quick release

> GEDORE vanadium steel 61CrSiV5, zinc-plated



Contents	⚖ kg	Code	No.
● mm 42 2,5 3 4 5 6 8	0.162	6347430	S 42-07

## SCL 42-70 HEXAGON ALLEN KEY SET

for in-hex screws

- > In robust metal clip
- > GEDORE vanadium steel 61CrSiV5, zinc-plated



Contents		Code	No.
● mm 2,5 3 4 5 6 8 10	0.360	6347350	SCL 42-70

## SCL 42 K-70 HEXAGON ALLEN KEY SET

for in-hex screws

- > In robust metal clip
- > Execution K with ball end
- > GEDORE vanadium steel 61CrSiV5, zinc-plated

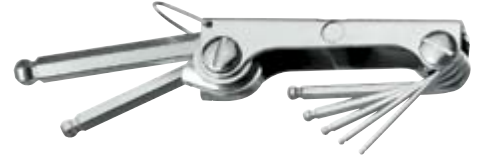

Contents		Code	No.
● mm 2,5 3 4 5 6 8 10	0.361	6371140	SCL 42 K-70

## SCL 42-90 A HEXAGON ALLEN KEY SET

for in-hex screws

- > In robust metal clip
- > GEDORE vanadium steel 61CrSiV5, zinc-plated



Contents		Code	No.
● AF 5/64 3/32 7/64 1/8 9/64 5/32 3/16 7/32 1/4"	0.260	6354800	SCL 42-90 A

## SCL 43 TX-80 CRANKED SOCKET KEY SET

for recessed TORX® screws

- > In robust metal clip
- > TORX® = reg. trademark of Acument Intellectual Properties, LLC. USA



Contents		Code	No.
● T9 T10 T15 T20 T25 T27 T30 T40	0.286	6346460	SCL 43 TX-80

## 42 X CRANKED ALLEN SOCKET SCREWDRIVER

for multi-point screws XZN

- > Acc. to DIN 65253, tips acc. to DIN 2325
- > GEDORE vanadium steel 50CrV4, chromated

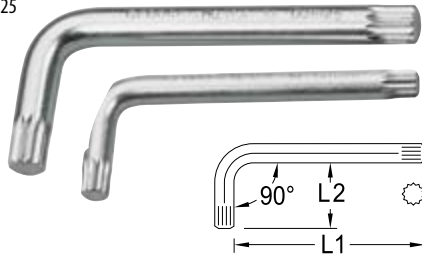

	M	L <sub>1</sub>	L <sub>2</sub>		Code	No.
M 4	63	20	0.009	1531212	42 X 4	
M 5	75	30	0.015	6350060	42 X 5	
M 6	86	34	0.025	6350140	42 X 6	
M 8	98	40	0.043	6350220	42 X 8	
M 10	110	46	0.085	6350300	42 X 10	
M 12	124	52	0.124	6350490	42 X 12	
M 14	139	59	0.191	6350570	42 X 14	
M 16	156	72	0.308	6350650	42 X 16	
M 18	178	81	0.333	6350730	42 X 18	

## 43 CRANKED SOCKET KEY

for multi-spline screws RIBE®

- > GEDORE vanadium steel 50CrV4, chromated
- > RIBE® = reg. trademark of Richard Bergner GmbH & Co. KG, Schwabach, Germany

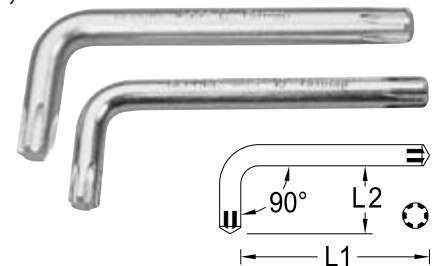

	M	L <sub>1</sub>	L <sub>2</sub>		Code	No.
M 5	71	25	0.016	6352270	43 5	
M 6	80	28	0.025	6352350	43 6	
M 8	90	32	0.049	6352430	43 8	
M 10	100	36	0.084	6352510	43 10	
M 12	112	40	0.135	6352780	43 12	
M 14	125	45	0.203	6352860	43 14	

## H 43 TX CRANKED SOCKET KEY SET

for recessed TORX® screws

- > In blue LDPE holder
- > Chrome-vanadium steel 50CrV4, gun-metal finish
- > TORX® = reg. trademark of Acument Intellectual Properties, LLC. USA

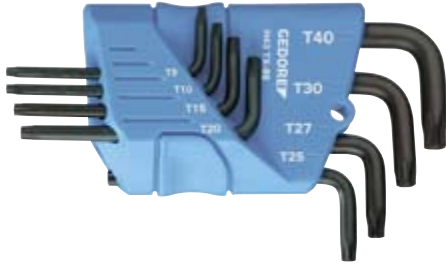

Contents	kg	Code	No.
43 TX T7 T8 T9 T10 T15 T20 T25 T30 T40	0.120	1531417	H 43 TX-09
43 TX T9 T10 T15 T20 T25 T27 T30 T40	0.129	1531425	H 43 TX-88
43 TX T10 T15 T20 T25 T27 T30 T40 T45	0.168	1531433	H 43 TX-08

## 43 TX-09 CRANKED SOCKET KEY SET

for recessed TORX® screws

- > In blue PVC wallet
- > Chrome-vanadium steel 50CrV4, gun-metal finish
- > TORX® = reg. trademark of Acument Intellectual Properties, LLC. USA



Contents	kg	Code	No.
43 TX T7 T8 T9 T10 T15 T20 T25 T30 T40	0.115	6360960	43 TX-09

## 43 TX CRANKED SOCKET KEY

for recessed TORX® screws

- > Chrome-vanadium steel 50CrV4, gun-metal finish
- > TORX® = reg. trademark of Acument Intellectual Properties, LLC. USA

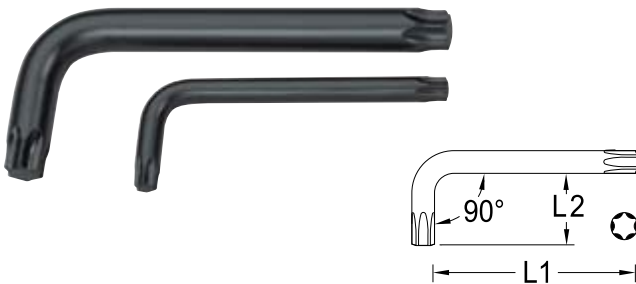

Code	M	mm	L <sub>1</sub>	L <sub>2</sub>	kg	Code	No.
T6	M2	1,69	42	16	0.003	6363550	43 TX T6
T7	M2,5	1,99	48	16	0.003	6363630	43 TX T7
T8	M2,5	2,31	48	16	0.004	6363710	43 TX T8
T9	M3	2,50	48	16	0.004	6363980	43 TX T9
T10	M3 - M3,5	2,74	51	17	0.005	6364010	43 TX T10
T15	M3,5 - M4	3,27	54	18	0.006	6364280	43 TX T15
T20	M4 - M5	3,86	57	19	0.008	6364360	43 TX T20
T25	M4,5 - M5	4,43	60	20	0.010	6364440	43 TX T25
T27	M4,5 - M6	4,99	64	21	0.016	6364520	43 TX T27
T30	M6 - M7	5,52	70	24	0.022	6364600	43 TX T30
T40	M7 - M8	6,65	76	26	0.031	6364790	43 TX T40
T45	M8 - M10	7,82	83	29	0.046	6364870	43 TX T45
T50	M10	8,83	95	32	0.060	6364950	43 TX T50
T55	M12	11,22	108	35	0.122	6365090	43 TX T55
T60	M14	13,25	120	38	0.187	6365170	43 TX T60

## H 43 KTX-07 CRANKED SOCKET KEY SET

for recessed TORX® screws

- > In blue LDPE holder
- > With ball end
- > Chrome-vanadium steel 50CrV4, gun-metal finish
- > TORX® = reg. trademark of Acument Intellectual Properties, LLC. USA



Contents	kg	Code	No.
43 KTX T10 T15 T20 T25 T27 T30 T40	0.169	1531441	H 43 KTX-07



# 43 KTX CRANKED SOCKET KEY

for recessed TORX® screws, with ball end

- > Working angle approx. 25°
- > Chrome-vanadium steel, gun-metal finish
- > TORX® = reg. trademark of Acument Intellectual Properties, LLC. USA

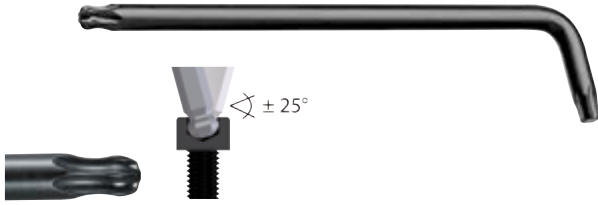

⊕	mm	mm	L <sub>1</sub>	L <sub>2</sub>	kg	Code	No.
T10	M3 - M3,5	2,74	73	17	0.006	6367110	43 KTX T10
T15	M3,5 - M4	3,27	83	17	0.009	6367380	43 KTX T15
T20	M4 - M5	3,86	94	18	0.012	6367460	43 KTX T20
T25	M4,5 - M5	4,43	96	18	0.015	6367540	43 KTX T25
T27	M4,5 - M6	4,99	106	20	0.024	6367620	43 KTX T27
T30	M6 - M7	5,52	119	24	0.033	6367700	43 KTX T30
T40	M7 - M8	6,65	132	26	0.049	6367890	43 KTX T40

# 708 TORX® GAUGE

- > Easy identification of TORX® sizes, internal E4-E16, external T10-T60
- > TORX® = reg. trademark of Acument Intellectual Properties, LLC. USA



Contents	kg	Code	No.
⊕ E4 - E16	0.022	1394428	708
⊕ T10 - T60			

# 173 CRANKED SCREWDRIVER

for slotted head screws

- > Acc. to DIN 5200, blade tips acc. to DIN ISO 2380-2
- > Chrome-vanadium steel, matt nickel-plated



mm	mm	mm	kg	Code	No.
3.5	0.6	90	0.010	6437180	173 3,5
4.0	0.8	100	0.013	6437850	173 4
5.5	1.0	125	0.025	6436100	173 5,5
8.0	1.2	150	0.050	6436370	173 8
10.0	1.6	175	0.087	6437930	173 10
12.0	2.0	200	0.127	6436530	173 12

# 174 CRANKED SCREWDRIVER

for cross-head screws PH

- > Acc. to DIN 5208, tips acc. to DIN ISO 8764-1 PH
- > Chrome-vanadium steel, matt nickel-plated

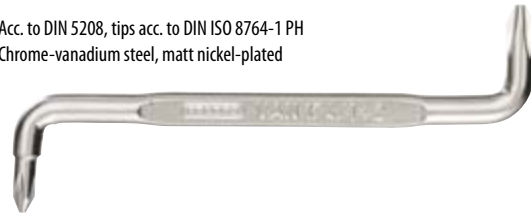

⊕ PH	mm	mm	kg	Code	No.
1-2	M2 - M5	100	0.029	6436880	174 1
3-4	M6 - M10	200	0.121	6436960	174 3

## VARIOUS

# 149 MAGNETIZER AND DEMAGNETIZER

- > Magnetizes or demagnetizes screwdrivers, tweezers and similar tools made from steel
- > Blue housing, made from high-quality plastic, unbreakable, cadmium-free



L	H	W	kg	Code	No.
52	26	50	0.088	6416500	149

# 156 S SQUARE BLADED AWL

- > Blue handle with hanging hole
- > Blade bright nickel-plated



mm	mm	kg	Code	No.
100	200	0.084	6424520	156 S



8133-180  
GEDORE  
Made in Austria

0.5-2.5<sup>2</sup>

CRIMP

GED

# PLIERS

COMBINATION PLIERS  
>370



SIDE CUTTERS /  
END CUTTING NIPPERS  
>373



FLAT NOSE /  
ROUND NOSE PLIERS  
>376



MECHANICS PLIERS  
>379



BOWDEN CABLE CUTTER /  
CABLE SHEARS  
>380



WIRE-STRIPPING PLIERS  
>382



ELECTRONIC PLIERS / ACCES-  
SORIES, STRIPPING TOOLS  
>383



CRIMPING PLIERS  
>393



CIRCLIP PLIERS  
>400



GRIP WRENCHES  
>407



PIPE WRENCHES /  
SPECIAL PLIERS  
>411



WATER PUMP /  
UNIVERSAL PLIERS  
>415



BOLT CUTTERS  
>419



BLACKSMITH'S TONGS  
>420



PLIERS ASSORTMENTS  
>421



# FEEL THE MARKED DIFFERENCE WITH THE GEDORE PLIER HANDLES

## Everything handled securely

- › Use of the best-possible steels, most up-to-date machinery and environmentally-friendly production processes
- › Our tool specialists vouch for exactness in processing and continuous refinements
- › Unique manufacturing processes and special tool treatment bring about the best in results
- › Stringent quality checks after each production step ensure a constantly high level
- › Professional service up to the development of special customised tools

## Precision, dimensioned accuracy and exactness of fitting

- › High-grade industrial quality for the toughest forms of continuous use and safety in everyday work
- › High bending stiffness thanks to GEDORE special hardened and tempered steel
- › GEDORE pliers do not fracture or splinter when overloaded but deform under incorrect use, therefore posing a lower risk of injury to the user
- › GEDORE pliers rest comfortably in the hand (M/XL/XXL) - the most important requirement, in fact, for non-taxing and safe working

## Intelligently designed or the MIN-MAX principle

- › Benefits in practical application from optimum utilization made of the laws of leverage.
- › Maximum power transfer of the pliers with a minimum effort required
- › For the pliers this means: optimum transfer of power - very high cutting performance
- › For those using the pliers this means: precise, fatigue-free and ergonomic working
- › The specially developed "power pliers" stands up well particularly in hard continuous operations (higher clamping forces with up to 35 % less effort exerted)



## Powerful gripping made easy

- › Fitted with anti-slip nubs and finger protection - for a firm grip
- › Ergonomically ideally placed hard and soft elements ensure fatigue-free working
- › Kind-to-hands feel, extensive hand contact surface
- › Anti-slip nubs support thumb gripping
- › They provide thumb with the right hold and ensure reliable plier guidance
- › This is true particularly for pulling or rotating movements with the pliers



# MANUFACTURING PROCESS FOR 8250 COMBINATION PLIERS



**1**  
Blank cropped to size from C50 hardened and tempered steel.



**2**  
Hot forged in the double forging die. The excess burr is removed under an eccentric press.



**3**  
The blanks are "normalised" to obtain an even finer-grain, more uniform structure with optimum strength. After descaling, the blanks are calibrated for the following work steps.



**4**  
The head is machined in a CNC-controlled machining centre. The rivet hole is drilled and counter-bored. The joint clearance and the outer contour are milled. The geometry of the joint area and the coarse and fine toothing are broached.



**5**  
The joint faces are precision milled. The pliers head takes on its final form.



**6**  
The moving and fixed pliers legs are riveted together. A smooth-moving joint with no play is the essential requirement for safe one-handed operation.



**7**  
In a chamber hardening kiln, the pliers are hardened in a protective gas atmosphere, quenched in oil and finally annealed. The design of the hardening kiln ensures that the process gases are uniformly distributed, which has a positive effect on the desired material properties.



**8**  
The cutting edges of GEDORE pliers are once again induction hardened. The additional hardness that this achieves ensures a good cutting performance and a long life between sharpening.



**9**  
The pliers head is ground to achieve a flush geometry.



**10**  
The surface is cleaned by sand blasting. The removal of scale and grease is necessary for the follow-on electroplating process.



**11**  
Nickel-plated and matt-chrome-plated to prevent dazzle. The electrolytically deposited nickel coating provides the corrosion protection. The electroplated chrome improves the look and gives the pliers a perfect finish.



**12**  
TL pliers are painted black by a robot, using water soluble paint.



**13**  
The 2-component handles are pressed on and bonded.



**14**  
The plastic coating on the handles is built up by multiple dipping in liquid immersion compound.

## The complete range: form and function perfection

- > Extremely wide selection in sizes, finish and grip designs for specialists and non-specialists alike
- > Model JC = chrome-plated, 2-component handle protectors
- > Model TL = black with blue dipped handle protector
- > Available individually or in practical sets, in the module or in assortments



On request also available with SB pack (plastic hanging clip, Euro perforation for self-service display wallboard)

VDE TOOLS

>570



# POWER PLIERS



Maximum cutting performance yet with a low level of effort expended thanks to an optimum interaction of cutting geometry, eccentric rivet bearing and ergonomic handle design.

The pliers are hot-forged from high-grade GEDORE special steel and then oil-hardened.

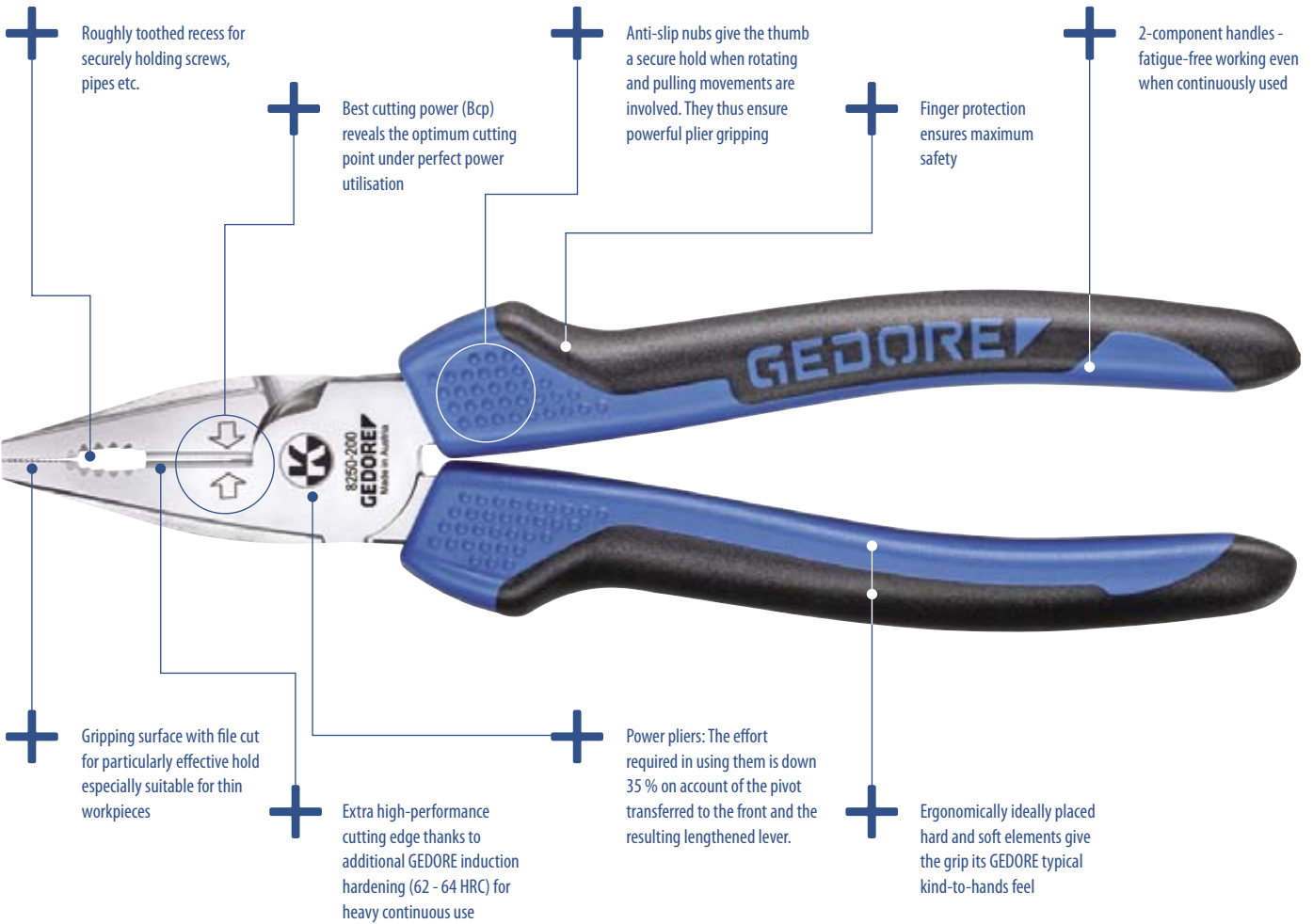

## Force equation

$$\Sigma M (\text{rivet}) = 0 = F(\text{hand}) \times L(\text{hand}) = F(\text{cutting edges}) \times L(\text{optimum cutting edge distance})$$

The eccentric pivot point ensures that the hand torque (force x path) applied over the rivet (fulcrum) is effectively and positively translated into cutting force.

$$F(\text{cutting edges}) = \frac{F(\text{hand}) \times L(\text{hand})}{L(\text{optimum cutting edge distance})}$$

The greatly improved effective length of this design achieves increased cutting force. Optimised lever ratios bring a 35% reduction in the effort required.

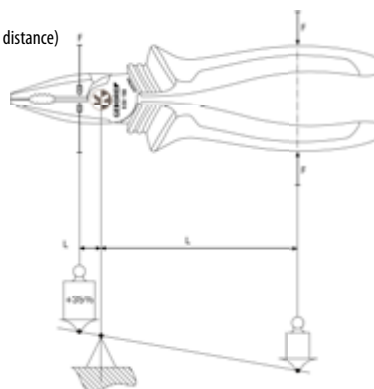

## Working principle POWER PLIERS

"K" identifies the GEDORE Power Pliers range, offering increased cutting and gripping force with up to 35% less effort.





## Cutting forms as per DIN ISO 5742

### Cutting without cutting bevel (without chamfer)

For flush cutting of plastics.

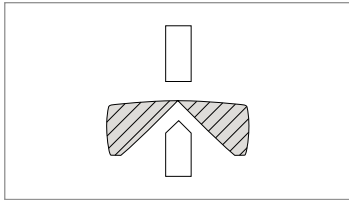

### Cutting with a slight cutting bevel (small degree of chamfer)

Especially for the electronics field.

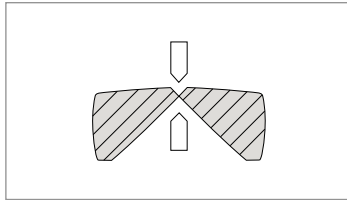

### Cutting with cutting bevel (with chamfer)

Especially for steel wire, piano wire and springs. The large chamfer ensures a long service life of the cutting edge.

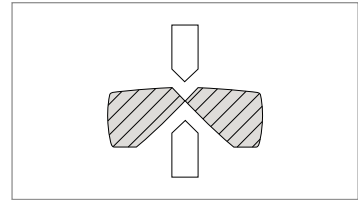

## Joint types

### lap joint

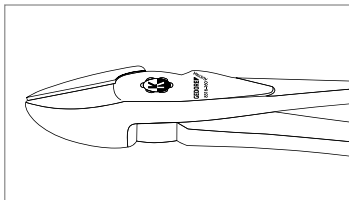

### inserted joint

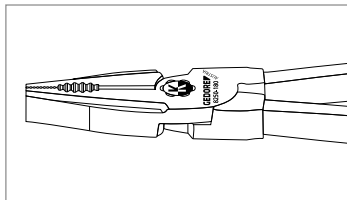

### safety-box joint

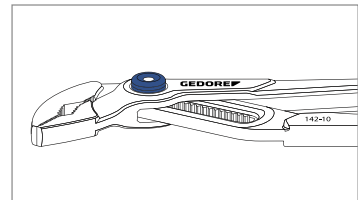

## Basic jaw forms

### flat jaws

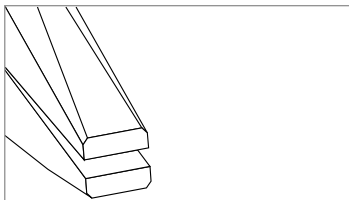



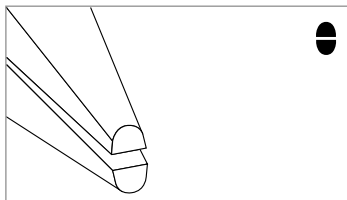

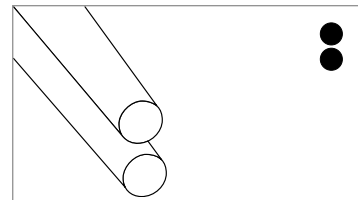

### flat/round jaws



### round jaws



## Wire categories to DIN ISO 5744

Material examples	Wire hardness	Tensile strength N/mm <sup>2</sup>	
 Nail, wire nail, bronze wire	soft	approx. 600	
 Wire rope fibre, steel wire	medium-hard	approx. 1600	
 Spring-steel wire	hard/Piano wire	approx. 2300	

### SAFETY NOTES PLIERS

> 642



## Combination Pliers

# 8248 ANGLED COMBINATION PLIERS

- > For the toughest of demands
- > Optimum utilisation of the power in one's hands
- > No forced positioning of the hand
- > Fatigue-free working over a long period made possible
- > High-grade GEDORE special hardened and tempered steel for high cutting performance and a long service life

- > Induction-hardened precision cutting edges, hardness 63 - 65 HRC
- > For all wires including piano wire, 1.6 mm
- > Hot-drop forged
- > JC = chrome-plated, with 2-component handles
- > TL = steel-grey, with blue dipped non-slip handles



JC

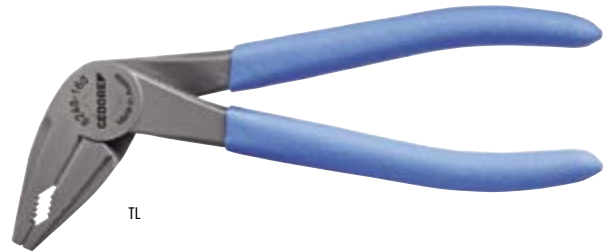

TL

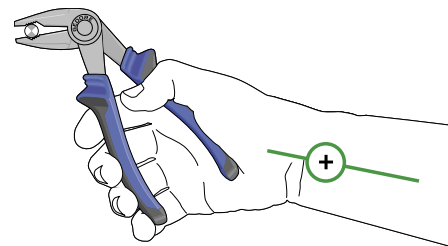

+ A pliers head angled at 60° goes easy on your joints and tendons. And you keep the workpiece in view at the same time

### TRADITIONAL COMBINATION PLIERS

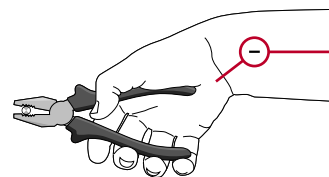

- Traditional gripping faces with standard gripping on pipes and screws

+ Specially offset teeth in the grip surfaces for best-possible gripping on pipes and screws

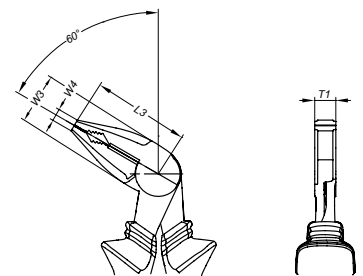

## 8248 ANGLED COMBINATION PLIERS

L	L <sub>2</sub>	W <sub>2</sub>	W <sub>1</sub>	T <sub>1</sub>		Code	No.
165	46	24	6	10	0.245	2276585	8248-160 JC
165	46	24	6	10	0.220	2276763	8248-160 TL



# 8200 COMBINATION PLIERS

- > Practical small combination pliers especially for confined spaces or as car-boot tool
- > For flat and round material
- > For medium-hard wire, 1.6 mm

- > Similar to DIN ISO 5746
- > GEDORE special hardened and tempered steel, drop-forged, oil-hardened and annealed
- > JC = chrome-plated, with 2-component handles

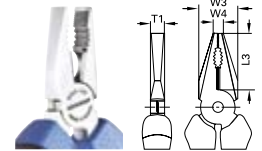

L	L <sub>3</sub>	W <sub>3</sub>	W <sub>4</sub>	T <sub>1</sub>		Code	No.
125	25	16	3.2	7.6	0.117	6730480	8200-125 JC

# 8210 COMBINATION PLIERS

German pattern

- > Acc. to DIN ISO 5746
- > Reinforced type, for tough continuous operations
- > Lay-on cutter box
- > For flat and round material
- > For medium-hard wire, 1.6 mm
- > Induction-hardened precision cutting edges, hardness 62 - 64 HRC
- > GEDORE special hardened and tempered steel, drop-forged, oil-hardened and annealed
- > JC = chrome-plated, with 2-component handles
- > TL = steel-grey, with blue dipped non-slip handles

# 8245 COMBINATION PLIERS

Euro pattern

- > Acc. to DIN ISO 5746
- > Universal model with slimline head, ideal for confined spaces
- > Induction-hardened precision cutting edges, hardness 62 - 64 HRC
- > For flat and round material
- > For medium-hard wire, 1.6 mm
- > GEDORE special hardened and tempered steel, drop-forged, oil-hardened and annealed
- > JC = chrome-plated, with 2-component handles
- > TL = steel-grey, with blue dipped non-slip handles



JC



JC

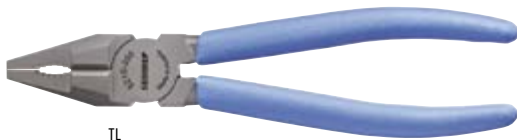

TL



TL

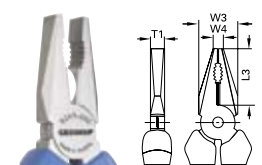
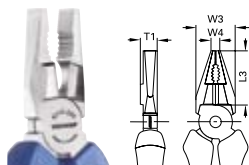

L	L <sub>3</sub>	W <sub>3</sub>	W <sub>4</sub>	T <sub>1</sub>		Code	No.
160	34	23.0	5.8	10.8	0.217	6731100	8210-160 JC
160	34	23.0	5.8	10.8	0.173	6711340	8210-160 TL
180	38	27.0	6.4	11.8	0.284	6731530	8210-180 JC
180	38	27.0	6.4	11.8	0.227	6711420	8210-180 TL
200	42	29.5	7.4	12.5	0.356	6732180	8210-200 JC
200	42	29.5	7.4	12.5	0.296	6711850	8210-200 TL

L	L <sub>3</sub>	W <sub>3</sub>	W <sub>4</sub>	T <sub>1</sub>		Code	No.
160	34	23.0	5.8	8.8	0.218	6733070	8245-160 JC
160	34	23.0	5.8	8.8	0.174	6730050	8245-160 TL
180	38	27.0	6.4	9.8	0.280	6733150	8245-180 JC
180	38	27.0	6.4	9.8	0.230	6730210	8245-180 TL
200	42	29.5	7.4	10.5	0.363	6733230	8245-200 JC
200	42	29.5	7.4	10.5	0.297	6730720	8245-200 TL



# 8250 POWER COMBINATION PLIERS

- > Acc. to DIN ISO 5746
- > For heavy continuous use
- > Good lever action for easy cutting
- > For flat and round material

- > To cut all wire types including piano wire, 1.6 mm
- > GEDORE special hardened and tempered steel, drop-forged, oil-hardened and annealed
- > JC = chrome-plated, with 2-component handles
- > TL = steel-grey, with blue dipped non-slip handles



JC

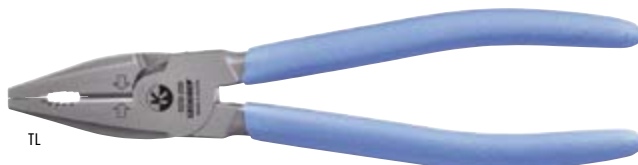

TL



> Power pliers: The effort required in using them is down 35 % on account of the pivot transferred to the front and the resulting lengthened lever.

Inductively hardened cutting edges (62 - 64 HRC) ensure constant cutting power over a long time span.

High-grade 2-component handles with finger protection enable work to be done ergonomically and to the exclusion of tiredness



Gripping surface with file-cut for a particularly effective hold

Roughly toothed gripping surfaces for securely holding screws, pipes etc.

Maximum cutting performance yet with a low level of effort expended thanks to an optimum interaction of cutting geometry, eccentric rivet bearing and ergonomic handle design.

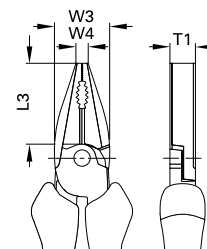

## 8250 POWER COMBINATION PLIERS

L	L <sub>2</sub>	W <sub>3</sub>	W <sub>4</sub>	T <sub>1</sub>		Code	No.
160	35.0	22.8	5.8	10.4	0.225	1429566	8250-160 JC
160	35.0	22.8	5.8	10.4	0.180	1429574	8250-160 TL
180	38.5	25.6	6.5	11.0	0.282	6707070	8250-180 JC
180	38.5	25.6	6.5	11.0	0.227	6707660	8250-180 TL
200	39.5	27.0	6.5	12.4	0.360	6707310	8250-200 JC
200	39.5	27.0	6.5	12.4	0.288	6707740	8250-200 TL

## 8250-225 TL POWER COMBINATION PLIERS

**NEW**

> Convex handle shape for a high force build-up\*

\* Crowned surfaces/handles - i.e. which are hardly rounded - prevent unfavourable, punctual peak forces. As a result, the force is evenly spread across your hand.

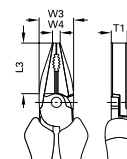

L	L <sub>2</sub>	W <sub>3</sub>	W <sub>4</sub>	T <sub>1</sub>		Code	No.
225	42.2	27.7	6.5	13.0	0.351	6708040	8250-225 TL

VDE 8250 / VDE 8250 H

>582



1500 CT1-142

>111



## Side Cutters / End Cutting Nippers

8313  
SIDE CUTTER

for plastic

- > Without cutting edge bevel, for flush cutting of plastic parts or similar soft materials
- > Black, cutting faces flat-ground, with compression spring for automatic opening
- > With blue dipped non-slip handles (TL)

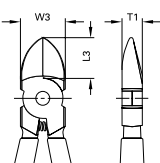
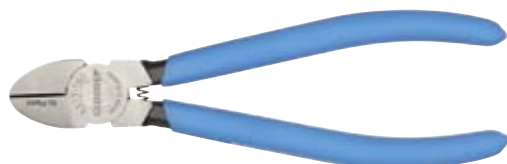

L	L <sub>3</sub>	W <sub>3</sub>	T <sub>1</sub>		Code	No.
125	16.0	17.0	8.5	0.116	6745910	8313-125 TL
140	18.5	18.5	9.5	0.131	6746050	8313-140 TL
160	19.0	22.0	10.0	0.184	6746130	8313-160 TL

8314  
SIDE CUTTER

Swedish pattern

- > Acc. to DIN ISO 5749
- > With slender head - ideal for confined spaces
- > Induction-hardened precision cutting edges, hardness 63 - 65 HRC
- > For medium-hard wire, 1.6 mm
- > GEDORE special hardened and tempered steel, drop-forged, oil-hardened and annealed
- > JC = chrome-plated, with 2-component handles
- > TL = steel-grey, with blue dipped non-slip handles

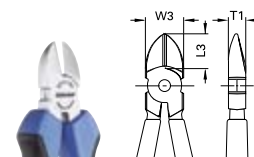
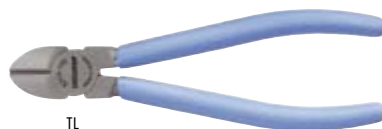

L	L <sub>3</sub>	W <sub>3</sub>	T <sub>1</sub>	Ø		Code	No.
125	16.0	17.0	8.5	1,6	0.146	6742300	8314-125 JC
125	16.0	17.0	8.5	1,6	0.107	6740870	8314-125 TL
140	18.5	18.5	9.5	1,6	0.176	6742730	8314-140 JC
140	18.5	18.5	9.5	1,6	0.129	6740950	8314-140 TL
160	19.0	22.0	10.0	1,6	0.230	6743380	8314-160 JC
160	19.0	22.0	10.0	1,6	0.173	6741090	8314-160 TL

8315  
ELECTRICIANS' SIDE CUTTER

- > Double-function electricians' side cutters: for cutting and stripping wire
- > Stripping notches for single- and multi-core wire, 1.5 mm<sup>2</sup> and 2.5 mm<sup>2</sup> conductor cross-section
- > Induction-hardened precision cutting edges, hardness 61 - 63 HRC
- > GEDORE special hardened and tempered steel, drop-forged, oil-hardened and annealed
- > JC = chrome-plated, with 2-component handles

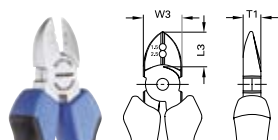

L	L <sub>3</sub>	W <sub>3</sub>	T <sub>1</sub>	mm <sup>2</sup>		Code	No.
160	19	22	10	1,5 / 2,5	0.235	1396722	8315-160 JC

8314-180  
POWER SIDE CUTTER

Swedish pattern

- > Convex handle shape for a high force build-up\*
- > Acc. to DIN ISO 5749
- > With slender head - ideal for confined spaces
- > Induction-hardened precision cutting edges, hardness 63 - 65 HRC
- > For hard wire/piano wire
- > Max. cutting capacity Ø 1.6 - 2.0 mm
- > GEDORE special hardened and tempered steel, drop-forged, oil-hardened and annealed
- > JC = chrome-plated, with 2-component handles
- > TL = steel-grey, with blue dipped non-slip handles
- \* Crowned surfaces/handles - i.e. which are hardly rounded - prevent unfavourable, punctual peak forces. As a result, the force is evenly spread across your hand.

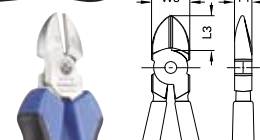

L	L <sub>3</sub>	W <sub>3</sub>	T <sub>1</sub>	Ø		Code	No.
185	25.0	26.0	11.0	1,6	0.300	2910934	8314-180 JC
185	25.0	26.0	11.0	1,6	0.243	2910926	8314-180 TL



- > Power pliers: The effort required in using them is down 35 % on account of the pivot transferred to the front and the resulting lengthened lever.
- > High-grade 2-component handles with finger protection enable work to be done ergonomically and to the exclusion of tiredness



# 8316 POWER SIDE CUTTER

- > Acc. to DIN ISO 5749
- > Good lever action for easy cutting
- > For hard wire/piano wire
- > Max. cutting capacity  $\varnothing$  1.4 - 2.0 mm

- > GEDORE special hardened and tempered steel, drop-forged, oil-hardened and annealed
- > JC = chrome-plated, with 2-component handles
- > TL = steel-grey, with blue dipped non-slip handles



JC

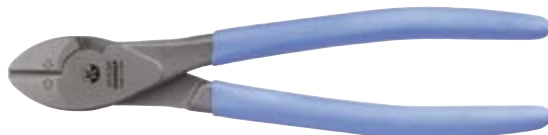

TL

Inductively hardened cutting edges (63 - 65 HRC) ensure constant cutting power over a long time span.

Maximum cutting performance yet with a low level of effort expended thanks to an optimum interaction of cutting geometry, eccentric rivet bearing and ergonomic handle design.

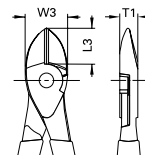

## 8316 POWER SIDE CUTTER

American pattern

L	L <sub>2</sub>	W <sub>3</sub>	T <sub>1</sub>	∅	kg	Code	No.
140	17.0	22.0	9.5	1,4	0.175	6744190	8316-140 JC
140	17.0	22.0	9.5	1,4	0.146	6711930	8316-140 TL
160	19.0	24.5	10.0	1,6	0.236	6744510	8316-160 JC
160	19.0	24.5	10.0	1,6	0.195	6712070	8316-160 TL

L	L <sub>2</sub>	W <sub>3</sub>	T <sub>1</sub>	∅	kg	Code	No.
180	22.6	26.0	11.0	1,8	0.265	1439588	8316-180 JC
180	22.6	26.0	11.0	1,8	0.225	1439596	8316-180 TL
200	22.0	28.0	11.0	2,0	0.340	6745080	8316-200 JC
200	22.0	28.0	11.0	2,0	0.270	6712150	8316-200 TL

VDE 8316 / VDE 8316 H >584

S 8303 JC >422



## 8318

### LEVER-ACTION SIDE CUTTER

- > For hard wire/piano wire 1.6 mm
- > Double-jointed for maximum cutting performance
- > Head and joint made from special steel, head gun-metal finished
- > Handles chrome-plated and PVC coated



Ø	↳ mm ▷	↳ "inch ▷	⚖ kg	Code	No.
1,6	160	6.1/2	0.213	6745590	8318-160 TL

## 8370

### LEVER-ACTION END CUTTING NIPPER

- > Acc. to DIN ISO 5748
- > For hard wire/piano wire - values see table
- > Double-lever mechanism for maximum cutting performance
- > C65 tool steel, fully forged
- > GEDORE blue varnished
- \* not standardised



Ø	↳ mm ▷	↳ "inch ▷	⚖ kg	Code	No.
2	180	7	0.460	6750830	8370-180
2	210	8.1/2	0.610	6751050	8370-210
2,5	*	235	9.1/4	6751210	8370-235

## 8367

### END CUTTING NIPPER POWER

- > Acc. to DIN ISO 5748
- > Good lever action for easy cutting
- > Induction-hardened precision cutting edges, hardness 63 - 65 HRC
- > For hard wire/piano wire 1.6 mm
- > GEDORE special hardened and tempered steel, drop-forged, oil-hardened and annealed
- > JC = chrome-plated, with 2-component handles
- > TL = steel-grey, with blue dipped non-slip handles

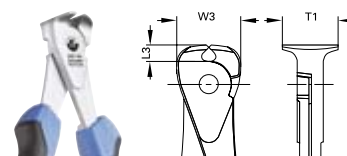
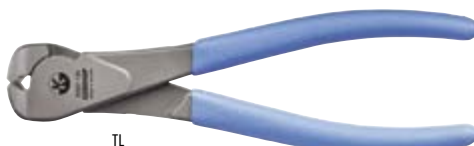

L	L <sub>2</sub>	W <sub>2</sub>	T <sub>1</sub>	Ø	⚖ kg	Code	No.
160	6.9	27	23.5	1,6	0.254	6749150	8367-160 JC
160	6.9	27	23.5	1,6	0.242	6712230	8367-160 TL

## 8380

### TOWER PINCER

- > Heavy-duty wire braid and mesh-cutting pincers
- > Acc. to DIN ISO 9242, Form A
- > Induction-hardened precision cutting edges, hardness 61 - 63 HRC
- > For medium-hard wire, 1.6 mm
- > Heads ground, steel-grey, with blue dipped non-slip handles (TL)
- > Geometrically optimised head and handle areas for ergonomic use
- > In high-quality tool steel

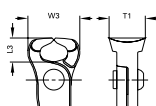

L	L <sub>2</sub>	W <sub>2</sub>	T <sub>1</sub>	⚖ kg	Code	No.
230	16	31	22	0.358	6752020	8380-225 TL
250	16	35	25	0.423	6752100	8380-250 TL
280	16	35	25	0.541	6752290	8380-280 TL

## 8381

### PINCER

- > Standard heavy-duty pincers
- > Acc. to DIN ISO 9243, Form A
- > Induction-hardened precision cutting edges, hardness 61 - 63 HRC
- > Heads ground, steel-grey, with blue dipped non-slip handles (TL)
- > In high-quality tool steel

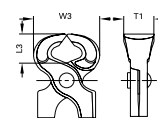

L	L <sub>2</sub>	W <sub>2</sub>	T <sub>1</sub>	⚖ kg	Code	No.
160	21.0	48	20	0.258	6752370	8381-160 TL
180	21.0	50	23	0.362	6751800	8381-180 TL
200	23.5	55	26	0.442	6751990	8381-200 TL
225	23.5	55	25	0.514	6752450	8381-225 TL
250	23.5	58	27	0.586	6752530	8381-250 TL

## Flat Nose / Round Nose Pliers

### 8110 FLAT NOSE PLIERS

without cutting edge, serrated

- > Acc. to DIN ISO 5745
- > Short jaws, serrated gripping faces
- > For holding and bending
- > GEDORE special hardened and tempered steel, drop-forged, oil-hardened and annealed
- > JC = chrome-plated, with 2-component handles
- > TL = steel-grey, with blue dipped non-slip handles

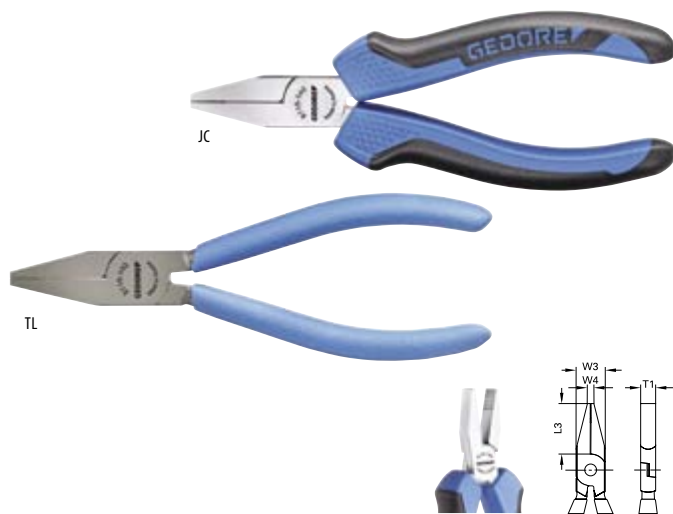

L	L <sub>3</sub>	W <sub>3</sub>	W <sub>4</sub>	T <sub>1</sub>		Code	No.
140	28.5	16.5	3.6	8.5	0.154	6711690	8110-140 JC
140	28.5	16.5	3.6	8.5	0.118	6711500	8110-140 TL

### 8120 FLAT NOSE PLIERS

without cutting edge, serrated

- > Acc. to DIN ISO 5745
- > Long jaws, serrated gripping faces
- > For holding and bending
- > GEDORE special hardened and tempered steel, drop-forged, oil-hardened and annealed
- > JC = chrome-plated, with 2-component handles
- > TL = steel-grey, with blue dipped non-slip handles



L	L <sub>3</sub>	W <sub>3</sub>	W <sub>4</sub>	T <sub>1</sub>		Code	No.
160	51	16.5	3.4	9	0.170	6715170	8120-160 JC
160	51	16.5	3.4	9	0.133	6710370	8120-160 TL

### 8112 ROUND NOSE PLIERS

serrated

- > Similar to DIN ISO 5745
- > Short jaws, serrated gripping faces
- > For gripping and bending
- > GEDORE special hardened and tempered steel, drop-forged, oil-hardened and annealed
- > JC = chrome-plated, with 2-component handles
- > TL = steel-grey, with blue dipped non-slip handles

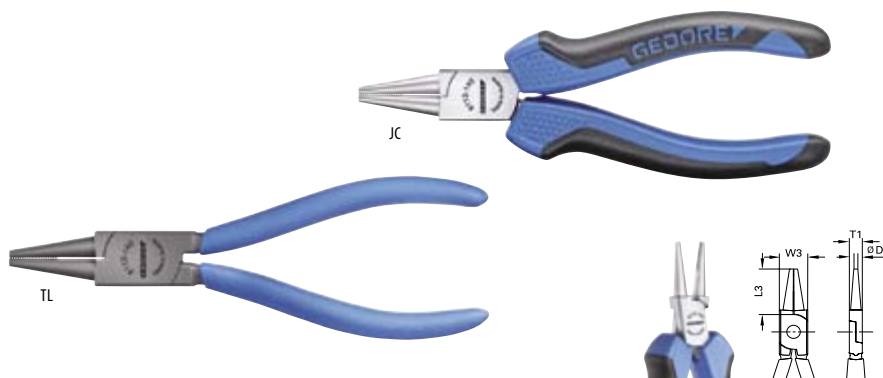

L	L <sub>3</sub>	W <sub>3</sub>	D <sub>1</sub>	T <sub>1</sub>		Code	No.
140	29.0	17.0	2.5	8.5	0.146	6713390	8112-140 JC
140	28.5	16.5	2.5	8.5	0.110	6713200	8112-140 TL

VDE 8120 / VDE 8120 H

>585

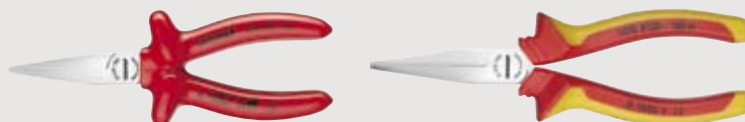

## 8122

### ROUND NOSE PLIERS

serrated

- > Acc. to DIN ISO 5745
- > Long jaws, serrated gripping faces
- > For gripping and bending
- > GEDORE special hardened and tempered steel, drop-forged, oil-hardened and annealed
- > JC = chrome-plated, with 2-component handles
- > TL = steel-grey, with blue dipped non-slip handles

L	L <sub>3</sub>	W <sub>3</sub>	D <sub>1</sub>	T <sub>1</sub>		Code	No.
160	48	16.5	2.5	8.7	0.150	6716810	8122-160 JC
160	48	16.5	2.5	8.7	0.114	6710530	8122-160 TL

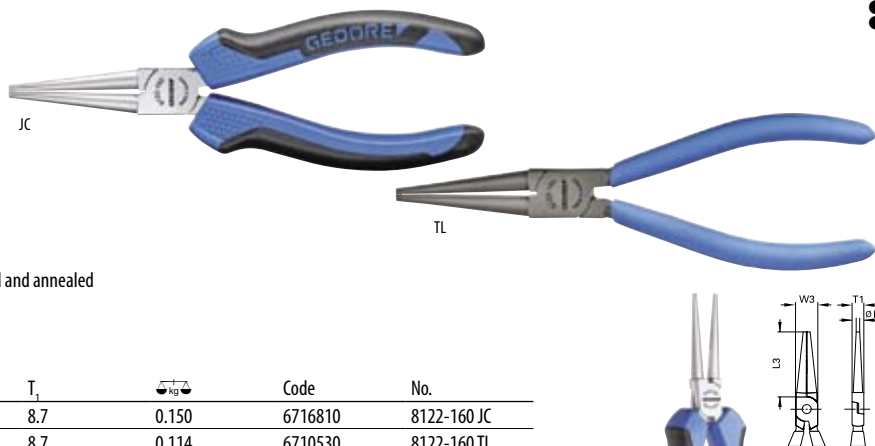

## 8132

### TELEPHONE PLIERS

with cutting edge, serrated, straight pattern

- > Acc. to DIN ISO 5745
- > Long, flat-round jaws, straight gripping faces, serrated
- > For holding, gripping, bending and cutting
- > Induction-hardened precision cutting edges, hardness 61 - 63 HRC
- > GEDORE special hardened and tempered steel, drop-forged, oil-hardened and annealed
- > JC = chrome-plated, with 2-component handles
- > TL = steel-grey, with blue dipped non-slip handles

L	L <sub>3</sub>	W <sub>3</sub>	W <sub>4</sub>	T <sub>1</sub>	T <sub>2</sub>		Code	No.
140	42.0	15.0	2.5	7.8	2.0	0.125	6718860	8132-140 JC
140	42.0	15.0	2.5	7.8	2.0	0.104	6710610	8132-140 TL
160	50.0	16.5	3.2	9.0	2.5	0.166	6719240	8132-160 JC
160	50.0	16.5	3.2	9.0	2.5	0.129	6710880	8132-160 TL
200	75.7	18.5	3.7	9.5	2.8	0.225	6719670	8132-200 JC
200	75.7	18.5	3.7	9.5	2.8	0.186	6710960	8132-200 TL

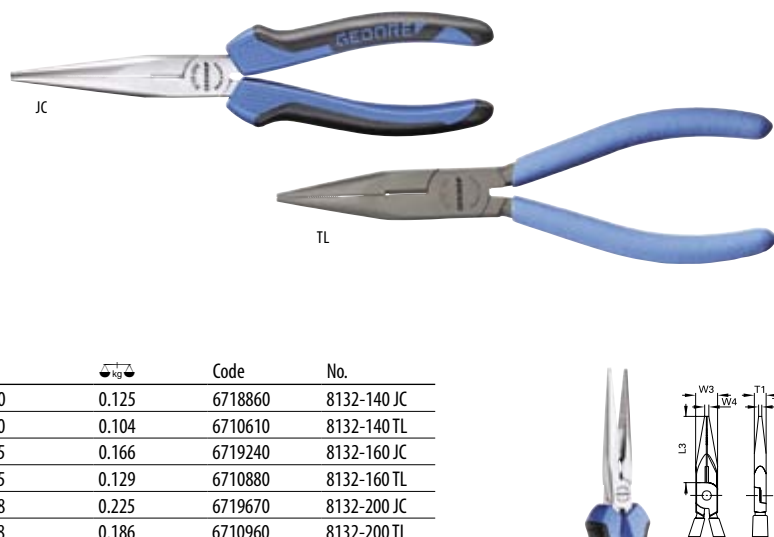

## 8132 AB

### BENT NOSE TELEPHONE PLIERS

with cutting edge, serrated, angled pattern

- > Similar to DIN ISO 5745
- > Long, flat-round jaws, angled gripping surfaces, serrated
- > 45° angled tips make gripping round the corner possible
- > Induction-hardened precision cutting edges, hardness 61 - 63 HRC
- > GEDORE special hardened and tempered steel, drop-forged, oil-hardened and annealed
- > JC = chrome-plated, with 2-component handles
- > TL = steel-grey, with blue dipped non-slip handles

L	L <sub>3</sub>	W <sub>3</sub>	W <sub>4</sub>	T <sub>1</sub>	T <sub>2</sub>		Code	No.
160	46.0	16.5	3.2	9.0	2.5	0.163	6720920	8132 AB-160 JC
160	46.0	16.5	3.2	9.0	2.5	0.125	6711180	8132 AB-160 TL
200	70.5	18.5	3.7	9.5	2.8	0.225	6721300	8132 AB-200 JC
200	70.5	18.5	3.7	9.5	2.8	0.190	6711260	8132 AB-200 TL

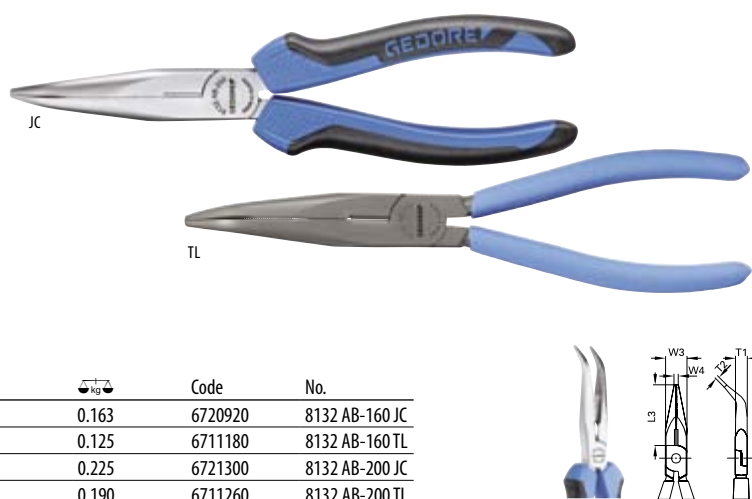

VDE 8122 / VDE 8122 H

>585



VDE 8132 / VDE 8132 H

>586



VDE 8132 AB / VDE 8132 AB H >586



# 8133 MULTIPLE PLIERS

- > Multifunctional pliers for the mechanical and electronic fields
- > Holding, cutting, insulation-stripping, crimping, squeezing
- > Flat-round jaws, straight gripping faces, serrated
- > For medium-hard wire, 1.6 mm
- > GEDORE special hardened and tempered steel, drop-forged, oil-hardened and annealed

- > JC = chrome-plated, with 2-component handles
- > TL = steel-grey, with blue dipped non-slip handles

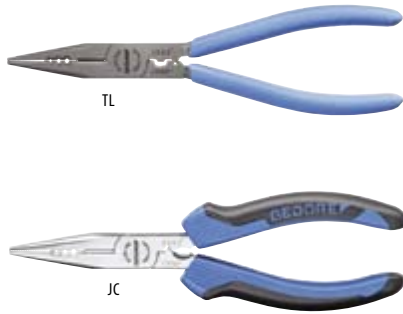

Stripping of wire sizes  
0.5/1.5/2.5 mm<sup>2</sup>

Crimping of conductor end-  
sleeves 0.5-2.5 mm<sup>2</sup>



## 8133 MULTIPLE PLIERS

with cutting edge, serrated, straight pattern

↳ mm ▶	⚖️	Code	No.
180	0.180	6722110	8133-180 JC
200	0.200	2676079	8133-200 JC
180	0.160	1997394	8133-180 TL
200	0.180	2676087	8133-200 TL

## 8135 TELEPHONE PLIERS

without cutting edge, serrated, straight pattern

- > Acc. to DIN ISO 5745, straight pattern
- > Flat-round tapered jaws, cross-hatched gripping surfaces and fine-tipped nose
- > Also suitable as needle nose soldering pliers
- > GEDORE special hardened and tempered steel, drop-forged, oil-hardened and annealed
- > JC = chrome-plated, with 2-component handles
- > TL = steel-grey, with blue dipped non-slip handles

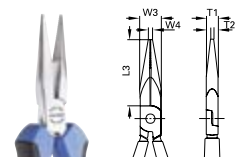
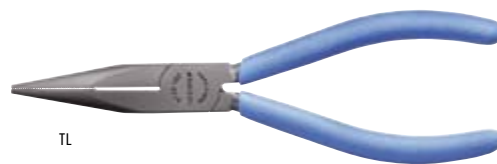

L	L <sub>1</sub>	W <sub>3</sub>	W <sub>4</sub>	T <sub>1</sub>	T <sub>2</sub>	⚖️	Code	No.
140	42	15.0	2.5	7.8	2.0	0.108	6722460	8135-140 TL
160	50	16.5	3.2	9.0	2.5	0.166	6722540	8135-160 JC
160	50	16.5	3.2	9.0	2.5	0.142	6722620	8135-160 TL

## Mechanics Pliers

### 8136 MECHANICS PLIERS

without wire cutter, straight pattern

- > Acc. to DIN ISO 5745
- > Flat-round tapered jaws, cross-hatched gripping surfaces
- > For holding, gripping and bending
- > Fine-tipped nose, for safe work in confined spaces
- > GEDORE special hardened and tempered steel, drop-forged, oil-hardened and annealed

- > JC = chrome-plated, with 2-component handles
- > TL = steel-grey, with blue dipped non-slip handles



JC



TL

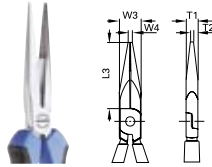

L	L <sub>2</sub>	W <sub>3</sub>	W <sub>4</sub>	T <sub>1</sub>	T <sub>2</sub>		Code	No.
200	75.7	18.5	3.7	9.5	2.8	0.241	6722700	8136-200 JC
200	75.7	18.5	3.7	9.5	2.8	0.201	6722890	8136-200 TL

### 8136 AB MECHANICS PLIERS

without wire cutter, angled pattern

- > Similar to DIN ISO 5745
- > Flat-round tapered jaws, cross-hatched gripping surfaces
- > 45° angled tips make gripping round the corner possible
- > Fine-tipped nose, for safe work in confined spaces
- > GEDORE special hardened and tempered steel, drop-forged, oil-hardened and annealed

- > JC = chrome-plated, with 2-component handles
- > TL = steel-grey, with blue dipped non-slip handles



JC

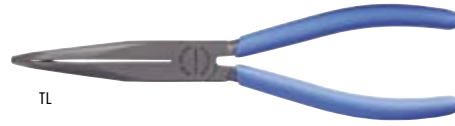

TL

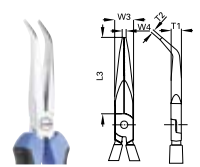

L	L <sub>2</sub>	W <sub>3</sub>	W <sub>4</sub>	T <sub>1</sub>	T <sub>2</sub>		Code	No.
200	70	18.5	3.7	9.5	2.8	0.239	6722970	8136 AB-200 JC
200	70	18.5	3.7	9.5	2.8	0.201	6723000	8136 AB-200 TL

### 8137 MECHANICS PLIERS

without wire cutter, offset pattern

- > Flat-round tapered jaws, cross-hatched gripping surfaces
- > Fine-tipped nose
- > Gently-curved jaws enable holding and gripping to be done in inaccessible places
- > GEDORE special hardened and tempered steel, drop-forged, oil-hardened and annealed
- > JC = chrome-plated, with 2-component handles

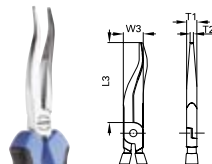

L	L <sub>2</sub>	W <sub>3</sub>	T <sub>1</sub>	T <sub>2</sub>		Code	No.
200	74	18.5	9.5	2.8	0.231	6723190	8137-200 JC

### 8138 MECHANICS PLIERS

without wire cutter, 30° angled

- > 30° angled flat-round tapered, hooked jaws, cross-hatched gripping surfaces 30°, fine-tipped nose
- > For safe gripping, positioning and loosening of round, oval and angular parts
- > Ideal for spark plug connectors and all kinds of hoses (e.g. radiator hoses)
- > GEDORE special hardened and tempered steel, drop-forged, oil-hardened and annealed
- > JC = chrome-plated, with 2-component handles

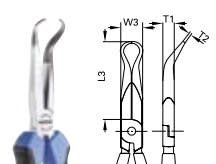

L	L <sub>2</sub>	W <sub>3</sub>	T <sub>1</sub>	T <sub>2</sub>		Code	No.
200	68	18.5	9.5	2.8	0.234	6723350	8138-200 JC



## Cable cutter

8317

## BOWDEN CABLE CUTTER/WIRE ROPE CUTTER



- > Crimping of bowden-cable sleeves and end-sleeves 1.5 mm and 2 mm
- > For cutting wire rope up to 2 mm diameter and bowden-cable sleeves up to 5 mm diameter as well as for medium-hard wire
- > With opening spring, transport lock and width adjustment
- > Induction-hardened cutting edges

- > Innovative GEDORE cutting form produces a precision cut
- > Low overall weight

l-mm		Code	No.
170	0.150	2011638	8317-160 JC

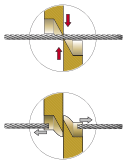
GEDORE  
WIRE ROPE CUTTER

- > Shearing cut - the cutting plates slide past each other and in this way dissect the material.
- > The wire rope is cleanly cut and retains its circular cross-section. It does not fan out.

## BOLT CUTTER

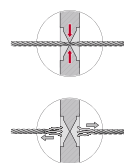

- > Notch cut; the cutters press into the material and create a notch. The material is compacted and thus separated.
- > The wire rope is compressed and thus loses its circular cross-section at the cut. The wire rope fans out as a result.

**Splicing:**

- > The old seafaring ability to separate the rope into its individual strands so as to then braid them into a loop or lengthen the rope with another rope without knotting.

**Fanning out:**

- > Fanning out - that is separating off into individual strands - is not wanted when cutting wire ropes. It is a very laborious business to splice wire ropes. That is why more up-to-date ways are available to incorporate loops in wire ropes. However, they require a smooth cut without any spliced strands.

8320 JC  
WIRE ROPE CUTTER**Execution:**

- > Easy-to-change cutting plates
- > Cutting plates of powder metallurgical high-speed steel (HSS). Manufactured in the MIM process (Metal Injection Molding)
- > Extremely high durability compared to traditional wire rope cutters
- > Extremely soft shearing cut reliably prevents the wire rope from fanning out
- > Tip: Can be operated with one hand of an average size up to a 5 mm Ø. Therefore optimally suited as shears in an emergency at sea.

**Jaws/Cutting edges:**

- > Specially arched cutting edges
- > Easy to replace cutting plates if worn
- > Hardness 62 - 65 HRC
- > Low force needed due to the optimum cutting-edge geometry
- > Two integrated press profiles for Bowden cable terminal sleeves and cable end sleeves

**Cutting performance:**

- > Wire ropes up to 1800 N/mm<sup>2</sup> with max. 6 mm Ø
- > (e.g. stainless steel wire ropes, wire ropes with steel and textile cores, Bowden cables, shears)
- > Wire up to 750 N/mm<sup>2</sup> with max. 4 mm Ø
- > (e.g. nails/wire nails, screws, bolts, ceiling banners)
- > Single- and multi-core copper and aluminium cables with max. 6 mm Ø

**Joint:**

- > Adjustable joint for precise cutting plate guidance
- > Latch to prevent unwanted opening

**Handles:**

- > JC = with 2-component handles

**Material/Finish:**

- > Plier body hot drop-forged
- > Chrome-plated



l-mm		Code	No.
200	0.480	2788799	8320-200 JC

E-8320

## SET OF SPARES FOR WIRE ROPE CUTTER

- > Consisting of: 2 cutting plates, 2 screws, 1 TORX® cranked socket key

Code	No.
2830779	E-8320-200



## Cable Shears

**NEW**

### 8090 CABLE SHEARS

- > For cutting single, multiple and fine-wire copper and aluminium cables up to  $\varnothing$  15 mm / 50 mm<sup>2</sup>
- > An easy precision-type cut
- > One-handed operation
- > No cable squeezing or deformation
- > Not suitable for steel wire, wire rope and hard-drawn copper wire
- > Opening spring for fatigue-free working
- > Cutting edges additionally inductively hardened
- > Precision ground for optimum action, new cutting-edge geometry
- > Adjustable screw joint with finger protection
- > Special hardened and tempered steel, forged, gun-metal finish, with dipped handle grips



mm <sup>2</sup>	∅	↳ mm	↳ inch	↳ kg	Code	No.
50	15	170	6.3/4	0.210	2959720	8090-170 TL

### 8092 CABLE SHEARS

- > Max. cutting capacity  $\varnothing$  10 mm<sup>2</sup>
- > For cutting multi-core copper and aluminium cables up to  $\varnothing$  10 mm
- > Precision ground for optimum action, new cutting-edge geometry
- > Not suitable for steel wire and hard copper
- > Hardness 55 HRC
- > Special hardened and tempered steel, forged, ground, with dipped handle grips



mm <sup>2</sup>	∅	↳ mm	↳ inch	↳ kg	Code	No.
10/50	10	160	6.1/2	0.180	2878356	8092-160 TL

### 8093 CABLE SHEARS

- > For cutting multi-core copper and aluminium cables up to  $\varnothing$  27 mm
- > Not suitable for wire ropes and steel wire
- > New cutting-edge geometry for a clean, smooth cut
- > Optimum lever action requires less effort
- > Compact design, low weight
- > Cutter head made from forged special tool steel
- > High-strength tubular aluminium handles, powder-enamelled, with rubber grips



∅	mm <sup>2</sup>	↳ mm	↳ inch	↳ kg	Code	No.
27	150	505	20	1.056	6724830	8093

### 8094 CABLE SHEARS

- > For cutting multi-core copper and aluminium cables up to  $\varnothing$  20 mm
- > When using first and final cuts, the diameter increases to  $\varnothing$  25 mm
- > The handle width remains within the range of ergonomic single-hand operation
- > First cut: Use the front blade to cut the cable sheath
- > Final cut: Place the cable in the back blade and separate the wire(s)
- > Cutting edges additionally inductively hardened
- > Precision ground for optimum action, new cutting-edge geometry
- > Adjustable screw joint with finger protection
- > Not suitable for steel wire or hard-drawn copper wire
- > Special hardened and tempered steel, forged, gun-metal finish, with dipped handle grips



∅	mm <sup>2</sup>	↳ mm	↳ inch	↳ kg	Code	No.
20	70	200	8.1/2	0.329	6724910	8094

VDE 8094

>580



### 8095 CABLE SHEARS

- > Shear's head in stainless steel, opens automatically
- > With impact-resistant plastic handles
- > With practical closure
- > For wire up to 10 mm<sup>2</sup>



mm <sup>2</sup>	↳ mm	↳ inch	↳ kg	Code	No.
10	160	6.1/2	0.134	6707820	8095-160



## Stripping Pliers

### 8097 STRIPPING PLIERS

automatic

- > With V-shaped cutting knife
- > For stripping single-strand conductors 0.2 - 6.0 mm<sup>2</sup>
- > Adjustable stripping length
- > With wire cutter up to 2 mm



L mm	L inch	mm <sup>2</sup>	kg	Code	No.
200	8	0,2-6	0.193	6702940	8097

### 8098 STRIPPING PLIERS

- > Opens automatically, with spring and adjusting screw
- > V-shaped cutting jaws for stripping the plastic insulation of single- and multi-core conductors
- > Adjuster and counter screws for easy setting to the desired wire or flex diameter
- > For 0.8 - 6.0 mm wires<sup>2</sup>
- > GEDORE special hardened and tempered steel, drop-forged, oil-hardened and annealed
- > JC = chrome-plated, with 2-component handles
- > TL = steel-grey, with blue dipped non-slip handles

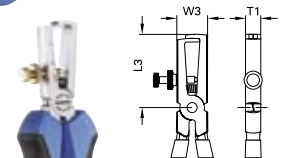

L	L <sub>1</sub>	W <sub>1</sub>	T <sub>1</sub>	mm <sup>2</sup>	kg	Code	No.
160	43.5	18.5	8.5	0,8-6	0.198	6708630	8098-160 JC
160	43.5	18.5	8.5	0,8-6	0.153	6710020	8098-160 TL

### 8099 STRIPPING PLIERS STRIP-FIX

- > Self-adjusting, for wires 0.5 - 5.0 mm<sup>2</sup>
- > V-shaped cutting jaws for stripping the plastic insulation of single and multi-core conductors
- > GEDORE special hardened and tempered steel, drop-forged, oil-hardened and annealed
- > JC = chrome-plated, with 2-component handles
- > Pair of spare knives no. E-8099



L mm	L inch	mm <sup>2</sup>	kg	Code	No.
160	6.1/2	0,5-5	0.217	6709520	8099-160 JC

### E-8099 PAIR OF SPARE KNIVES

for stripping pliers STRIP-FIX

kg	Code	No.
0.012	5709580	E-8099

VDE 8099 / VDE 8099 H

>581



## Electronic Pliers

# ELECTRONIC PLIERS

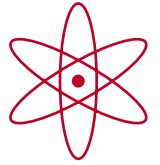

- > For bending, straightening and assembly work in the electronic and precision mechanical sector
- > GEDORE ESD-electronic-pliers dissipate electrostatic energy in a slow, controlled manner
- > Surfaces: Ground-steel - no flaking chrome parts to cause faults in electronic circuitry

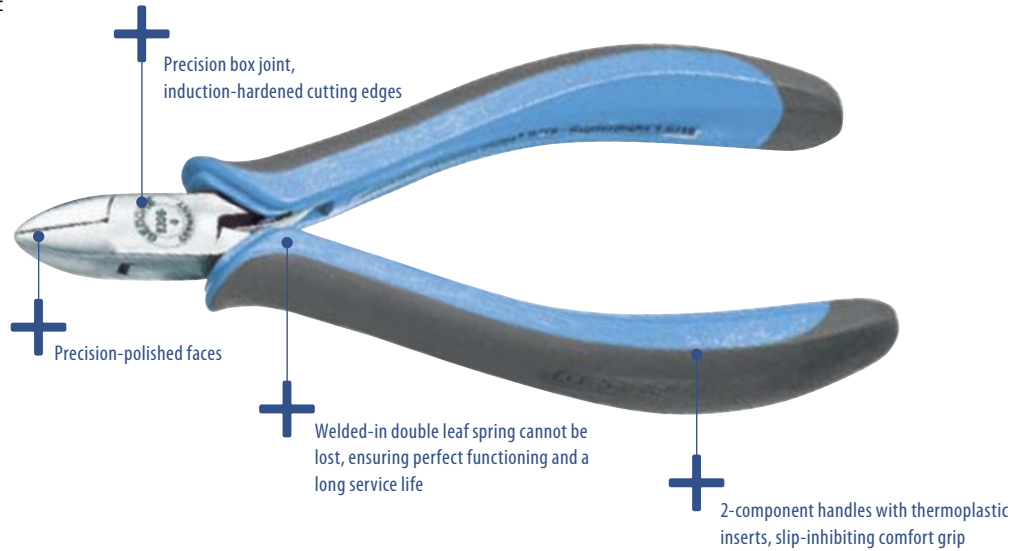

ESD = electrostatic discharge protection  
BL [JL] = Jaw length  
SL [CL] = Cutting edge length

## ATTENTION! SAFETY NOTE!

- > Due to the conductivity of the ESD 2-component handles, these tools must not be brought into contact with live conductors passing a voltage sufficient to cause an electric shock.



## CARE REGULATION

- > For safety reasons ESD pliers are not coated with chrome.
- > The surface of the pliers is of polished steel and therefore is at the mercy of corrosion.
- > As such, the surfaces of these pliers must be cleaned with a cloth at least 1x a day either during or after the work.
- > We would recommend our 8305 MT microfibre cloth

## S 8305 ESD ELECTRONIC PLIERS SET

6 pieces

- > Dimensions: L 230 x W 165 x H 55 mm
- > With microfibre cloth 8305 MT



Contents

8305-9  
8306-6  
8307-3

8307-4  
8306-1

8308-1  
E-8305 MT

0,680

Code  
1955551

No.  
S 8305 ESD

## Electronic side cutters

Induction-hardened precision cutting edges, 61-63 HRC

### 8306-1 ELECTRONIC SIDE CUTTER

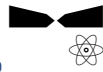

- > Oval head, with bevel
- > Induction-hardened precision cutting edges, 61 - 63 HRC

**Cutting values:**

- > Hard wire: 0.4 mm/AWG 26
- > Soft steel: 1.0 mm/AWG 18
- > Copper wire: 1.5 mm/AWG 15

> ESD = electrostatic discharge protection

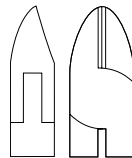
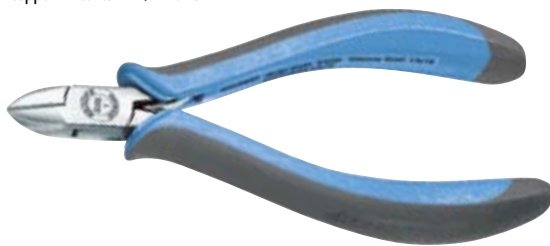

CL	mm	kg	Code	No.
12	125	0.080	6726450	8306-1

### 8306-2 MINIATURE ELECTRONIC SIDE CUTTER

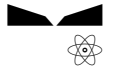

- > Short, oval head, with fine bevel
- > Induction-hardened precision cutting edges, 61 - 63 HRC

**Cutting values:**

- > Soft steel: 0.6 mm/AWG 22
- > Copper wire: 1.2 mm/AWG 16

> ESD = electrostatic discharge protection

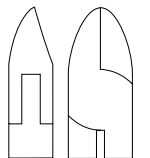
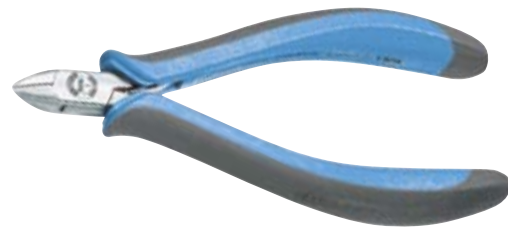

CL	mm	kg	Code	No.
9	120	0.071	6726530	8306-2

### 8306-4 ELECTRONIC SIDE CUTTER



- > Oval head, with fine bevel
- > Induction-hardened precision cutting edges, 61 - 63 HRC

**Cutting values:**

- > Soft steel: 1.0 mm/AWG 18
- > Copper wire: 1.5 mm/AWG 15

> ESD = electrostatic discharge protection

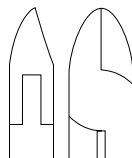

CL	mm	kg	Code	No.
14	125	0.081	6727180	8306-4

### 8306-5 MINIATURE ELECTRONIC SIDE CUTTER

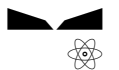

- > Pointed head, with fine bevel
- > Induction-hardened precision cutting edges, 61 - 63 HRC

**Cutting values:**

- > Hard wire: 0.4 mm/AWG 26
- > Soft steel: 1.0 mm/AWG 18
- > Copper wire: 1.2 mm/AWG 16

> ESD = electrostatic discharge protection

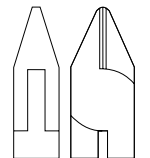
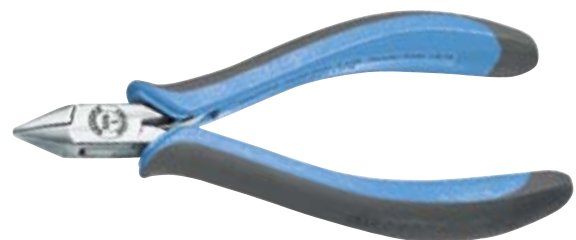

CL	mm	kg	Code	No.
12	125	0.079	6727340	8306-5

## 8306-6 MINIATURE ELECTRONIC SIDE CUTTER



- > Short, head pointed and flattened (relief-milled), with fine bevel
- > Induction-hardened precision cutting edges, 61 - 63 HRC
- Cutting values:**
- > Soft steel: 0.6 mm/AWG 22
- > Copper wire: 1.0 mm/AWG 18

> ESD = electrostatic discharge protection



CL	l mm	kg	Code	No.
10	120	0.072	6727500	8306-6

## 8306-8 MINIATURE ELECTRONIC SIDE CUTTER

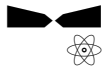

- > With wire gripper
- > Oval head, with bevel
- > Induction-hardened precision cutting edges, 61 - 63 HRC
- Cutting values:**
- > Hard wire: 0.4 mm/AWG 26
- > Soft steel: 1.0 mm/AWG 18
- > Copper wire: 1.5 mm/AWG 15

> ESD = electrostatic discharge protection

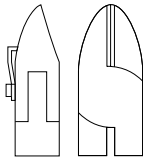

CL	l mm	kg	Code	No.
13	125	0.076	6727930	8306-8

### Electronic side cutter carbide

Tungsten-carbide cutting edges induction-hardened, 84-86 HRA

## 8306-7 ELECTRONIC SIDE CUTTER CARBIDE

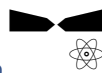

- > Oval head, with bevel
- > Tungsten-carbide cutting edges for an extremely long service life
- > Hardness 84 - 86 HRA
- Cutting values:**
- > Piano wire: 0.6 mm/AWG 22
- > Hard steel: 1.0 mm/AWG 18
- > Nickel wire: 1.2 mm/AWG 16

> ESD = electrostatic discharge protection

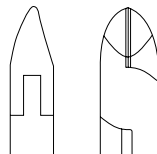
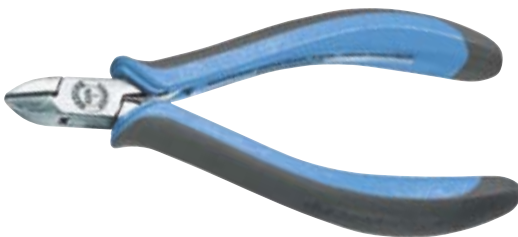

CL	l mm	kg	Code	No.
11	125	0.076	6727770	8306-7

## 8306-9 ELECTRONIC SIDE CUTTER CARBIDE

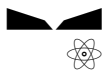

- > Tungsten-carbide cutting edges for an extremely long service life
- > Hardness 84 - 86 HRA
- > Pointed, slim head for work in confined spaces
- > Without bevel
- Cutting values:**
- > Piano wire: 0.3 mm
- > Hard steel: 0.5 mm
- > Nickel wire: 0.6 mm
- > Especially for cutting SMD components
- > With opening spring
- > ESD = electrostatic discharge protection

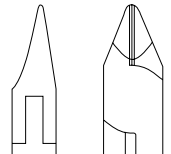

CL	l mm	kg	Code	No.
11	125	0.076	1743414	8306-9



# 8306-10

## ELECTRONIC SIDE CUTTER

### CARBIDE

- > Oval head, with special bevel, especially suitable for cutting glass fibre and Kevlar®
- > Tungsten-carbide cutting edges for an extremely long service life
- > Hardness 84 - 86 HRA
- > With opening spring
- > ESD = electrostatic discharge protection
- > Kevlar® is a registered trademark of the company DuPont

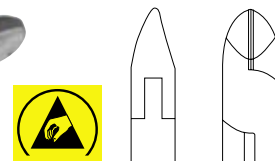

CL	↳ mm ↳	⚖️	Code	No.
11	125	0.077	1743422	8306-10

## Electronic diagonal cutters and end nippers

# 8308-1

## ELECTRONIC MINI DIAGONAL CUTTER

- > Pointed head, cutting edges angled 55°, with fine bevel
  - > For working in confined spaces
  - > Induction-hardened precision cutting edges, hardness 61 - 63 HRC
  - > With opening spring
  - > ESD = electrostatic discharge protection
- Cutting values:**
- > Hard steel: 0.4 mm/AWG 26
  - > Soft steel: 1.0 mm/AWG 18
  - > Copper wire: 1.2 mm/AWG 16

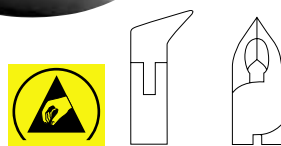

CL	↳ mm ↳	⚖️	Code	No.
12	125	0.076	1743600	8308-1

# 8308-3

## ELECTRONIC DIAGONAL CUTTER

- > Wide head and long cutting faces, with fine bevel
  - > Cutting edges angled 55°
  - > Head ground to a point on one side
  - > For working in confined spaces
  - > Induction-hardened precision cutting edges, hardness 61 - 63 HRC
- Cutting values:**
- > Hard steel: 0.4 mm/AWG 26
  - > Soft steel: 1.0 mm/AWG 18
  - > Copper wire: 1.5 mm/AWG 15
  - > With opening spring
  - > ESD = electrostatic discharge protection



CL	↳ mm ↳	⚖️	Code	No.
15	135	0.094	1743627	8308-3

# 8308-4

## ELECTRONIC END CUTTING NIPPER

- > Wide head and long cutting faces, with fine bevel
  - > High cutting performance
  - > Induction-hardened precision cutting edges, hardness 61 - 63 HRC
  - > With opening spring
  - > ESD = electrostatic discharge protection
- Cutting values:**
- > Hard steel: 0.4 mm/AWG 26
  - > Soft steel: 1.0 mm/AWG 18
  - > Copper wire: 1.5 mm/AWG 15



CL	↳ mm ↳	⚖️	Code	No.
15	135	0.098	1743635	8308-4



## Needle nose electronic pliers

### 8305-2 NEEDLE NOSE ELECTRONIC PLIERS

- > Extra long, half-round jaws, with file-cut surface
- > ESD = electrostatic discharge protection



JL	mm	kg	Code	No.
39	165	0.111	6725480	8305-2

### 8307-4 NEEDLE NOSE ELECTRONIC PLIERS

- > Slim, narrow, flat-round tapered jaws
- > Smooth-ground gripping faces
- > With opening spring
- > ESD = electrostatic discharge protection

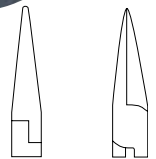

JL	mm	kg	Code	No.
31	145	0.074	1743562	8307-4

### 8305-6 FINE NEEDLE NOSE ELECTRONIC PLIERS

- > Extra slim jaws and fine point
- > Without file-cut
- > ESD = electrostatic discharge protection

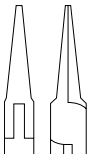

JL	mm	kg	Code	No.
40	160	0.101	6725720	8305-6

## Needle nose electronic pliers 45° angled

### 8307-3 NEEDLE NOSE ELECTRONIC PLIERS

- > Slim, narrow, flat-round tapered jaws, angled 45°
- > Gripping faces with fine file cut
- > With opening spring
- > ESD = electrostatic discharge protection

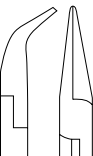

JL	mm	kg	Code	No.
22	140	0.081	1743554	8307-3

### 8307-7 LONG NOSE ELECTRONIC PLIERS

- > Extra long, flat-round tapered jaws, angled 45°
- > For bending and straightening jobs
- > Smooth-ground gripping faces
- > With opening spring
- > ESD = electrostatic discharge protection

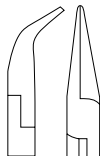

JL	mm	kg	Code	No.
35	165	0.113	1743597	8307-7

## Special electronic pliers

### 8305-7 ELECTRONIC DIAGONAL CUTTER

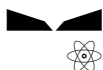

- > 30° angled cutting edges, with fine bevel
- > With slim head for confined spaces
- Cutting values:**
- > Soft steel: 0.6 mm/AWG 22
- > Copper wire: 0.8 mm/AWG 20
- > ESD = electrostatic discharge protection

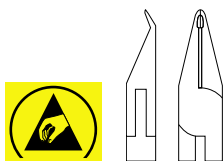
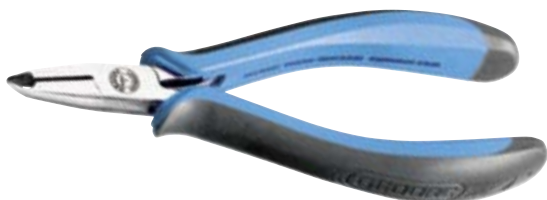

CL	mm	kg	Code	No.
6	135	0.073	6725990	8305-7

### 8305-9 FLAT NOSE ELECTRONIC PLIERS



- > Straight pattern
- > Without file-cut
- > ESD = electrostatic discharge protection

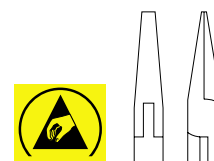

JL	mm	kg	Code	No.
23	135	0.073	6726370	8305-9

### 8308-6 ROUND NOSE ELECTRONIC PLIERS



- > For delicate work in the electronic sector, suitable for Kevlar®
- > Long service life
- > Tips tapering to Ø 1 mm, without file-cut
- > ESD = electrostatic discharge protection
- > Kevlar® is a registered trademark of the company DuPont

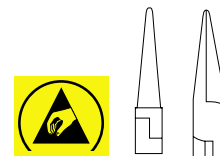

JL	mm	kg	Code	No.
20	135	0.078	1743651	8308-6

## Miniature Electronic Pliers

Made from high-performance hardened and tempered steel  
Induction-rehardened cutting edges, 59-61 HRC, faces phosphated

With opening spring  
2-component handles with secure-grip hand protection

### 8350-2 MINIATURE ELECTRONIC SIDE CUTTER

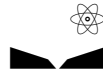

- > Sharp, narrow needle-point head
- > Cutting edges angled 21°, without bevel

**Cutting values:**  
> Copper wire: max. 0.8 mm / AWG 20



CL	mm	kg	Code	No.
8	132	0.073	1828967	8350-2

### 8350-3 MINIATURE ELECTRONIC SIDE CUTTER

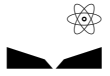

- > Sharp, narrow needle-point head
- > With wire-grip clamp
- > Cutting edges angled 21°, without bevel

**Cutting values:**  
> Copper wire: max. 1.0 mm / AWG 18



CL	mm	kg	Code	No.
8	132	0.082	1828975	8350-3

### 8350-5 MINIATURE ELECTRONIC DIAGONAL END CUTTING NIPPERS

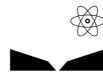

- > Wide, needle-point head
- > Cutting edges angled 48°, without bevel

**Cutting values:**  
> Copper wire: max. 1.3 mm / AWG 16



CL	mm	kg	Code	No.
8	136	0.085	1828991	8350-5

### 8350-6 MINIATURE ELECTRONIC SIDE CUTTER

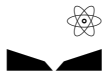

- > Wide, needle-point head
- > Cutting edges angled 21°, without bevel

**Cutting values:**  
> Copper wire: max. 1.3 mm / AWG 16  
> Medium-hard wire: max. 1.0 mm / AWG 18



CL	mm	kg	Code	No.
8	138	0.094	1829009	8350-6

### 8350-7 MINIATURE ELECTRONIC SIDE CUTTER

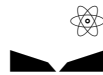

- > Wide, needle-point head
- > Cutting edges angled 21°, without bevel

**Cutting values:**  
> Copper wire: max. 1.3 mm / AWG 16



CL	mm	kg	Code	No.
8	138	0.086	1829017	8350-7

### 8350-8 MINIATURE ELECTRONIC SIDE CUTTER

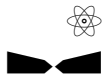

Power Line

- > Fabric insert for increased strength
- > Wide, needle-point head
- > Cutting edges angled 21°, with fine bevel

**Cutting values:**  
> Copper wire: max. 2.0 mm / AWG 12  
> Medium-hard wire: max. 1.6 mm / AWG 14



CL	mm	kg	Code	No.
12	140	0.110	1829025	8350-8



## 8350-9 MINIATURE ELECTRONIC SIDE CUTTER

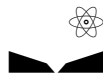

- > Wide, needle-point head
- > With wire-grip spring
- > Cutting edges angled 21°, without bevel

- Cutting values:**
- > Copper wire: max. 1.3 mm / AWG 16
  - > Medium-hard wire: max. 1.0 mm / AWG 18



CL	↳ mm	⚖️	Code	No.
10	138	0.094	1829033	8350-9

## 8351-1 MINIATURE ELECTRONIC SIDE CUTTER

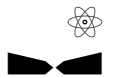

Power Line

- > Tungsten-carbide technology for heavy continuous use
- > Cutting edges angled 21°, with fine bevel, hardness 62 HRC

- Cutting values:**
- > Copper wire: max. 2.0 mm / AWG 12
  - > Medium-hard wire: max. 1.6 mm / AWG 14
  - > Piano wire: max. 0.6 mm / AWG 22



CL	↳ mm	⚖️	Code	No.
8	137	0.109	1829041	8351-1

## 8352-1 MINIATURE ELECTRONIC NEEDLE NOSE PLIERS



- > Short, narrow, smooth jaws
- > Surface phosphated



JL	↳ mm	⚖️	Code	No.
20	145	0.090	1829068	8352-1

## 8352-2 MINIATURE ELECTRONIC FLAT NOSE PLIERS



- > Long, narrow, smooth jaws



JL	↳ mm	⚖️	Code	No.
32	158	0.094	1829076	8352-2

## 8352-3 MINIATURE ELECTRONIC NEEDLE NOSE PLIERS



- > Long, narrow, serrated jaws
- > Cutting edges angled 45°



JL	↳ mm	⚖️	Code	No.
35	152	0.092	1829084	8352-3

## 8353-1 MINIATURE ELECTRONIC WIRE STRIPPING PLIERS

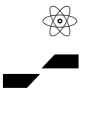

- > Multipurpose tool for cutting, stripping and terminal crimping



JL	↳ mm	mm <sup>2</sup>	AWG	⚖️	Code	No.
40	175	0,25-0,81	30-20	0.126	1829092	8353-1

## Accessories

### 8353-2

## INSULATING VARNISH STRIPPER

- > For removing insulating varnish
- > Plastic handles
- > Strips wires 0.6 mm<sup>2</sup> / AWG 22

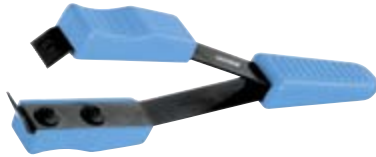

↳ mm ↳	mm <sup>2</sup>	AWG	⚖️	Code	No.
125	0,6	22	0.047	1828924	8353-2

### 8353-3

## WIRE STRIPPING KNIFE

- > For cable sizes 4-16 mm



∅	↳ mm ↳	⚖️	Code	No.
4-16	140	0.087	1828932	8353-3

### 8354-1

## DE-SOLDER TOOL

- > With suction action for removing solder residues when de-soldering electronic components



↳ mm ↳	⚖️	Code	No.
220	0.096	1828940	8354-1

## Stripping Tools

### 8147

## HEAVY-DUTY CABLE STRIPPING TOOL

- > Professional wire stripping tool with 2 cable hooks
- > Compact and user-friendly, even in the most difficult conditions
- > For cables (up to 40 mm ∅) with any kind of insulation
- > Blade can be locked in one of three positions (circular, straight or spiral cuts)
- > Cable capacity: 4.5 - 40 mm ∅
- > Insulation thickness: up to 4.5 mm

#### Dimensions:

- > with small cable hook: 150 x 42 x 30.5 mm
- > with large cable hook: 167 x 52 x 30.5 mm
- > E-8147 = Spare blade



∅	⚖️	Code	No.
4,5-40	0.196	1830856	8147

⚖️	Code	No.
0.002	1884719	E-8147



# 8146 STRIPPING PLIERS

with exchangeable module inserts, self-adjusting

- > Self-adjusting cutting and stripping tool (No. 8146) for modern electrical installations and equipment circuitry (90 % of all wires can be stripped without any adjustment of the tool)
- > The use of easily exchangeable module inserts allows accurate stripping of a wide range of insulation materials, including PVC and PTFE, with just one tool
- > Flat blade included in delivery
- > Dimensions: 191 x 123 x 20 mm

**Stripping capacity:**

- > 8146-1 with flat blade: 0.02-10 mm<sup>2</sup> / AWG 34-8 (for PVC insulation)
- > 8146-2 with round blade: 4-16 mm<sup>2</sup> / AWG 10-5
- > 8146-3 with V blade: PTFE 0.1-4 mm<sup>2</sup> / AWG 28-12 (for all types of insulation)

**Cutting values:**

- > Flexible wires up to 10 mm<sup>2</sup> / AWG 8
- > Rigid wires up to 1.5 mm<sup>2</sup> / AWG 16



8146



8146-1



8146-2



8146-3

Description	mm <sup>2</sup>	AWG		Code	No.
<b>Stripping pliers incl. module insert 8146-1</b>	0,02-10	34-8	0.180	1830805	8146
<b>Module insert with flat blade</b>	0,02-10	34-8	0.015	1830813	8146-1
<b>Module insert with round blade</b>	4-16	10-5	0.016	1830821	8146-2
<b>Module insert with V-blade</b>	0,1-4	28-12	0.016	1830848	8146-3

# 8139 CABLE END-SLEEVE PLIERS

- > For the simple pressing of conductor end-sleeves as per DIN 46228
- > With a V-block for stripping and cutting soft wire
- > In heat-treated steel as per DIN
- > TL = chrome-plated, with blue dipped handle protectors



mm <sup>2</sup>	↳ mm	↳ inch		Code	No.
<b>0,25-2,5</b>	155	6	0.186	6723510	8139-155TC
<b>0,5-16</b>	220	8.1/2	0.314	6723780	8139-220TC

# 8148 PRECISION STRIPPING TOOL

for data cables

- > User-friendly, easy to handle, all-round cut
- > Precision adjustment of cutting depth (adjuster wheel with 9 positions)
- > Replaceable blade
- > Safe, rounded, pocket design
- > Stripping capacity: 2.5 - 11 mm
- > Insulation thickness: up to 1.0 mm

**Dimensions:**

- > 90.5 x 39.5 x 19 mm
- > E-8148 = Spare blade

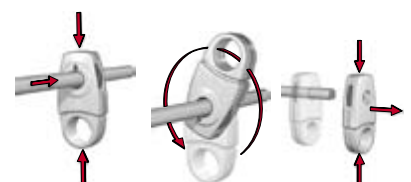

∅		Code	No.
<b>2,5-11</b>	0.043	1830864	8148

	Code	No.
<b>0.002</b>	1884727	E-8148



## Precision Crimp Wrenches

### 8141 PRECISION CRIMP WRENCH

for conductor end-sleeves

- > Flexible and lightweight
- > For right and left-handers
- > Positive locking to ensure crimping completion
- > Releasing mechanism to remove incorrect crimping and blockades
- > Precision eccentric setting for constant crimp quality and calibrating function

**Field of application:**

- > Self-adjusting from 0.5 to 6 mm<sup>2</sup> / AWG 22- AWG 10



mm <sup>2</sup>	↳ mm ↳	↳ inch ↳	⚖️ kg	Code	No.
0,5-6	197	7,75	0.423	1830759	8141

### 8142 PRECISION CRIMP WRENCH

for insulated terminals

- > Unique mechanism ensures a marked reduction of hand force as against other crimping tools
- > Flexible and lightweight
- > For right and left-handers
- > Positive locking to ensure crimping completion
- > Releasing mechanism to remove incorrect crimping and blockades
- > Precision eccentric setting for constant crimp quality and calibrating function

**Field of application:**

- > 1: 0.5-1.0 mm<sup>2</sup> / 20-18 AWG
- > 2: 1.5-2.5 mm<sup>2</sup> / 16-14 AWG
- > 3: 4.0-6.0 mm<sup>2</sup> / 12-10 AWG



mm <sup>2</sup>	↳ mm ↳	↳ inch ↳	⚖️ kg	Code	No.
0,5-6	255	10,04	0.626	1830767	8142

### 8152 - 8153 CRIMP WRENCH

for big terminals

- > Ratchet mechanism developed for uniform, reliable crimping of non-insulated crimp lug terminals to conductors and to secure completed crimping cycles and positive locking
- > Assymetrical press inserts for optimal termination
- > The press inserts mark the connector, to allow the correct use of the tool to be checked
- > Long handles enable double-handed use and effortless crimping



8152



8153



mm <sup>2</sup>	AWG	↳ mm ↳	⚖️ kg	Code	No.
4-25	12-3	300	0.650	2010313	8152
10-75	7-2/0	500	2.800	2010321	8153



## Crimping Pliers

### 8155 CRIMP WRENCH

for insulated connector

- > For red, blue and yellow insulated connectors, such as cable terminals, pin cable terminals, flat plugs, flat sockets, round plugs, round sockets, push connectors and parallel connectors
- > Easy to handle
- > Releasable positive locking
- > Kind-to-hands formed handles
- > GEDORE special steel, gun-metal finish

**Field of application:**

- > 1: 0.5-1.0 mm<sup>2</sup> / 20-18 AWG
- > 2: 1.5-2.5 mm<sup>2</sup> / 16-14 AWG
- > 3: 4.0-6.0 mm<sup>2</sup> / 12-10 AWG



mm <sup>2</sup>	AWG	L	W		Code	No.
0,5-6	20-10	220	80	0.480	2836823	8155

### 8156 CRIMP WRENCH

for non-insulated contacts

- > For non-insulated contacts with open crimping sleeve, such as flat plugs F 2.8; F4.8; F6.3 and F 9.5
- > Easy to handle
- > Releasable positive locking
- > Kind-to-hands formed handles
- > GEDORE special steel, gun-metal finish

**Field of application:**

- > 1: 0.25-0.5 mm<sup>2</sup> / 24-20 AWG
- > 2: 0.5-1.0 mm<sup>2</sup> / 20-18 AWG
- > 3: 4.0-6.0 mm<sup>2</sup> / 12-10 AWG
- > 4: 1.5-2.5 mm<sup>2</sup> / 16-14 AWG



mm <sup>2</sup>	AWG	L	W		Code	No.
0,25-6	24-10	220	80	0.510	2836831	8156

### 8157 CRIMP WRENCH

for cable lugs

- > For non-insulated contacts with closed crimping sleeve (W pressing) up to 16 mm<sup>2</sup> / AWG 6 and tubular cable lugs up to 10 mm<sup>2</sup> / AWG 6
- > Easy to handle
- > Releasable positive locking
- > Kind-to-hands formed handles
- > GEDORE special steel, gun-metal finish

**Field of application:**

- > 1: 0.1-0.35 mm<sup>2</sup> / 26-22 AWG
- > 2: 0.5-1.0 mm<sup>2</sup> / 20-18 AWG
- > 3: 1.5-2.5 mm<sup>2</sup> / 16-14 AWG
- > 4: 4.0-6.0 mm<sup>2</sup> / 12-10 AWG
- > 5: 10.0-16.00 mm<sup>2</sup> / 8-6 AWG



mm <sup>2</sup>	AWG	L	W		Code	No.
0,1-16	26-6	220	80	0.470	2836858	8157

## Crimp Wrench modular



### ADVANTAGES:

- › Reliable: parallel action ensures precision crimping
- › Easy to handle: components kept in view throughout the crimping process, easily accessible release function allows quick change of insert modules without the use of additional tools
- › Comfortable: lightweight, plastic-sheathed tool frame for comfort grip - even at low temperatures
- › Practical: insert modules, easy to change and clearly labelled, supplied in pairs on a pin in a storage box to prevent loss (storage boxes interconnect - like in a jigsaw puzzle)
- › Versatile and economical: just one tool base frame can be used with all the various insert modules to carry out a wide range of crimping processes, including heavy plug and socket connectors, coaxial connectors, optic fibres and RJ45 plugs.



### CHANGING OF THE CRIMPING INSERTS

- › By pressing the release of the crimping insert you can easily remove the crimping insert.
- › Remove the crimping insert and put in the required crimping insert while pressing down the release.



## 8140 MODULAR CRIMP WRENCH

- › Professional ratchet crimping pliers for most types of mechanical, electrical and electronic connectors
- › Dimensions: L 234 x H 64 x W 24 mm
- › Just one tool base frame (No. 8140) can be used with all insert modules
- › Module inserts changeable without tools



↳ mm ↳

234

kg

0.557

Code

1830546

No.

8140



## 8140-01/-02 MODULE INSERT

for insulated terminals

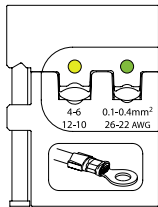

8140-01

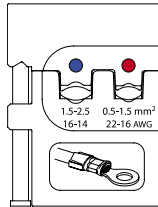

8140-02



mm <sup>2</sup>	AWG		Code	No.
<b>0,1-0,4 + 4-6</b>	26-22 + 12-10	0.075	1830554	8140-01
<b>0,5-1,5 + 1,5-2,5</b>	22-16 + 16-14	0.068	1830562	8140-02

## 8140-03/-04/-05 MODULE INSERT

for non-insulated terminals

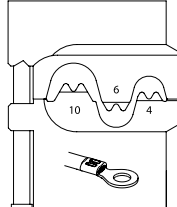

8140-03

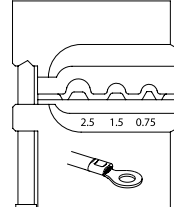

8140-04

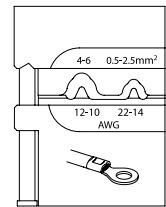

8140-05



mm <sup>2</sup>	AWG		Code	No.
<b>4-6-10</b>	12-10-8	0.056	1830570	8140-03
<b>0,75-1,5-2,5</b>		0.076	1830589	8140-04
<b>0,5-2,5 + 4-6</b>	22-14 + 12-10	0.056	1830597	8140-05

## 8140-06/-07/-08 MODULE INSERT

for conductor end-sleeves

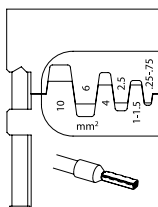

8140-06

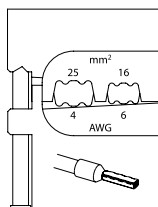

8140-07

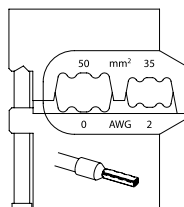

8140-08



mm <sup>2</sup>	AWG		Code	No.
<b>0,25-10</b>		0.056	1830600	8140-06
<b>16-25</b>	6-4	0.056	1830619	8140-07
<b>35-50</b>	2-0	0.056	1830627	8140-08

## 8140-09/-10/-11 MODULE INSERT

for flat plugs

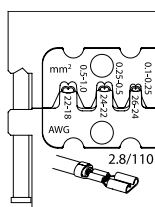

8140-09

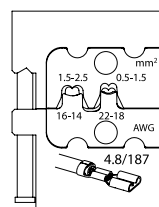

8140-10

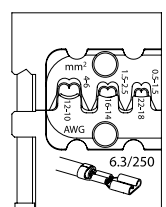

8140-11



Connector type	mm <sup>2</sup>	AWG		Code	No.
<b>2,8</b>	0,1-1	26-18	0.072	1830635	8140-09
<b>4,8</b>	0,5-2,5	22-14	0.056	1830643	8140-10
<b>6,3</b>	0,5-6	22-10	0.080	1830651	8140-11

## 8140-12 MODULE INSERT

for optical waveguides

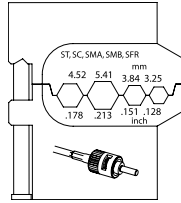

Ø	kg	Code	No.
4,52 5,41 3,84 3,25 mm .178 .213 .151 .128 in	0.056	1830678	8140-12

## 8140-14 MODULE INSERT

for coax cables

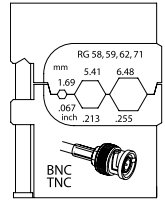

Connector type	Ø	kg	Code	No.
RG 58, 59, 62, 71	1,69 5,41 6,48 mm .067 .213 .255 in	0.056	1830694	8140-14

## 8140-16/-17 MODULE INSERT

for modular plugs

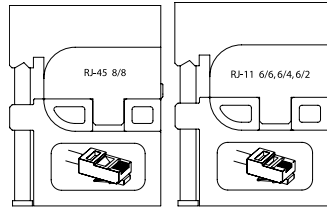

Connector type	kg	Code	No.
RJ-45, 8P/8C	0.050	1830716	8140-16
RJ-11, 6P/6C - 6P/4C - 6P/2C	0.048	1830724	8140-17

## 8140-18 MODULE INSERT

for heavy connectors

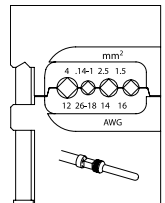

mm <sup>2</sup>	AWG	kg	Code	No.
0,14-4	26-12	0.056	1830732	8140-18

## 8140-20 MODULE INSERT

for lamellar contacts

> With seals 0.5 - 3.0 mm<sup>2</sup>

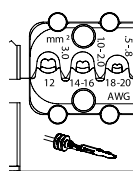

mm <sup>2</sup>	AWG	kg	Code	No.
0,5-3,0	20-12	0.056	1963384	8140-20

## 8140-21/-22 MODULE INSERT

for Dura Seal contacts

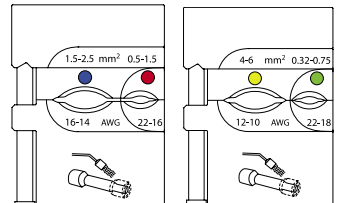

mm <sup>2</sup>	AWG	kg	Code	No.
0,5 - 1,5 / 1,5 - 2,5	22 - 16 / 16 - 14	0.080	1963392	8140-21
0,32 - 0,75 / 4 - 6	22 - 18 / 12 - 10	0.080	1963406	8140-22

## 8140-23 MODULE INSERT

for Solarlok®

> Suitable for Tyco Solarlok®: 2.5 - 4 - 6 mm<sup>2</sup>

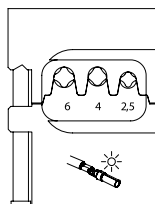

mm <sup>2</sup>	kg	Code	No.
2,5 - 4 - 6	0.086	2078082	8140-23

## 8140-24/-25 MODULE INSERT

for Multi Contact

> Suitable for Multi Contact MC 3 / MC 4: 2.5 - 4 - 6 mm<sup>2</sup>

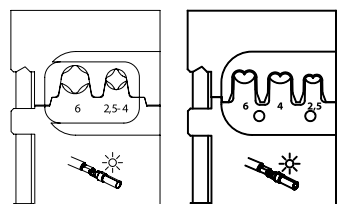

Connector type	kg	Code	No.
Multi Contact MC 3	0.056	2078090	8140-24
Multi Contact MC 4	0.700	2078104	8140-25



## Crimp Wrench Sets

### S 8140 A CRIMPING PLIERS SET AUTOMOTIVE

4 pieces

- > Practical set made up for specific requirements in automotive engineering
- > Ideal for high-standard crimping
- > Can be individually upgraded by purchasing additional module inserts
- > Module inserts changeable without tools
- > In practical blister packaging



S 8140 A

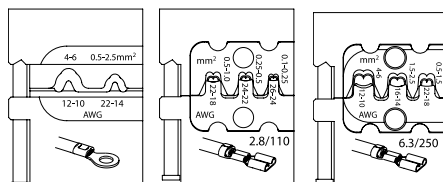

8140-05

8140-09

8140-11

Contents		Code	No.
<b>8140</b> 8140-09 -05 -11	0.754	1830910	S 8140 A

### S 8140 D CRIMPING PLIERS SET DATA COM

4 pieces

- > Practical set made up for specific requirements in data-communications installations
- > Ideal for high-standard crimping
- > Can be individually upgraded by purchasing additional module inserts
- > Module inserts changeable without tools
- > In practical blister packaging



S 8140 D

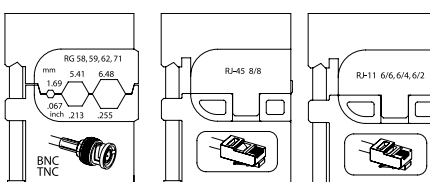

8140-14

8140-16

8140-17

Contents		Code	No.
<b>8140</b> 8140-14 -16 -17	0.711	1830937	S 8140 D

### S 8140 E CRIMPING PLIERS SET ELECTRONIC

4 pieces

- > Practical set made up for specific requirements for electricians
- > Ideal for high-standard crimping
- > Can be individually upgraded by purchasing additional module inserts
- > Module inserts changeable without tools
- > In practical blister packaging



S 8140 E

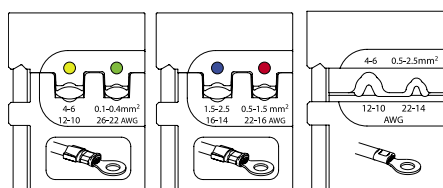

8140-01

8140-02

8140-05

Contents		Code	No.
<b>8140</b> 8140-01 -02 -05	0.760	1830899	S 8140 E

### S 8140 J CRIMPING PLIERS SET INDUSTRIAL

4 pieces

- > Practical set made up for specific requirements in industrial maintenance
- > Ideal for high-standard crimping
- > Can be individually upgraded by purchasing additional module inserts
- > Module inserts changeable without tools
- > In practical blister packaging



S 8140 J

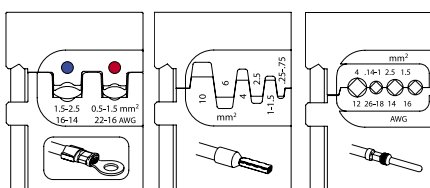

8140-02

8140-06

8140-18

Contents		Code	No.
<b>8140</b> 8140-02 -06 -18	0.752	1830929	S 8140 J



# S 8140 PN

## CRIMPING PLIERS SET STARTER

in plastic case

- > Without module inserts for individual composition
- > In practical plastic case



8140



S 8140 PN

Contents	 kg	Code	No.
<b>8140</b>	1.589	1963279	S 8140 PN

# RZB1-18CR

## PLIERS SET

2 pieces + accessories

- > In rugged plastic case



Contents	 kg	Code	No.
<b>8141</b>	1.480	1895249	RZB1-18CR
<b>8146</b>			
<b>End-sleeves</b>			
<b>0.50 0.75 1.00 1.50</b>			
<b>2.50 4.00 6.00</b>			

## Circlip pliers for external retaining rings (shafts)

### 8000 AE

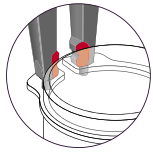

Flattened tip mounting makes it easier to get at the safety ring eyelets

Secure tip thanks to keyed press-fixing in the pliers head

With no retaining groove in the tips, the safety ring cannot be inadvertently bent and it remains absolutely flat. In addition no weakening of the tips from a retaining groove (notching-induced rated breaking point).

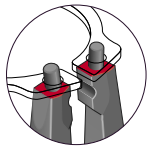

Large contact surface for the safety ring stops it becoming twisted

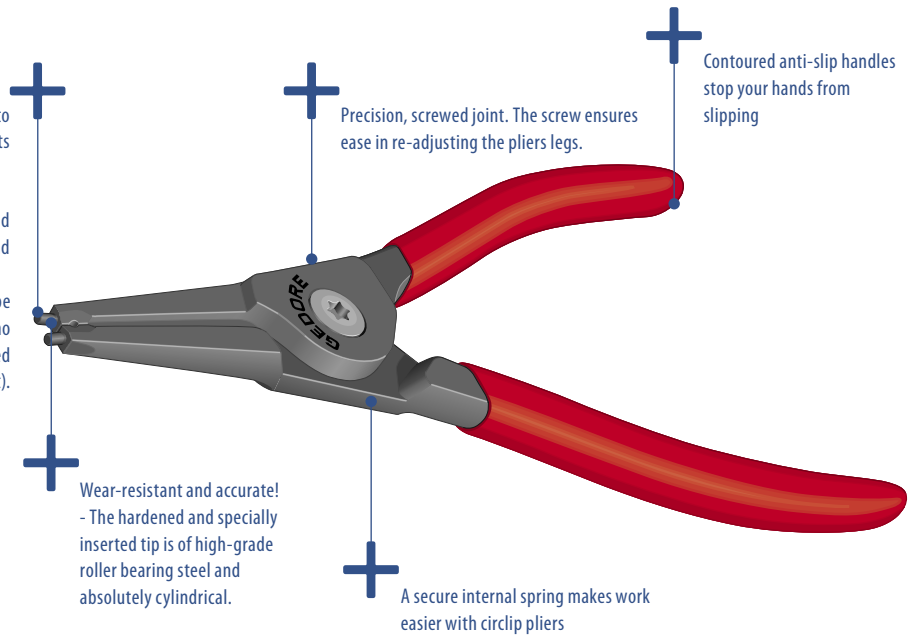

### TIP

**This thus lessens safety ring twisting!**

- > Always ensure that the fitting side is the right one when installing safety rings.
- > The safety ring "eyelets" are stamped and thus they are slightly conical.
- > To stop any ring twisting, the narrower side of the eyelets\* should rest on the pliers.

\* The bevel-free side is also the narrower side of the eyelets.

## 8000 AE 0 - AE 4 CIRCLIP PLIERS FOR EXTERNAL RETAINING RINGS

**NEW**

Form A

- > For safety rings as per DIN 471, DIN 983
- > DIN 5254 Form A
- > Straight jaws
- > Inside-positioned opening spring
- > Pliers basic body in GEDORE chrome-vanadium special steel
- > Pressed-in tips of highly wear-resistant roller bearing steel
- > Twisting-impeding tip geometry
- > Screwed joint connection
- > Steel-grey with red-dipped anti-slip handles



● mm	● inch	L	L <sub>1</sub>	d	⚖	Code	No.
3-10	5/32-3/8	144	39	0.9	0.090	2930633	8000 AE 0
10-25	3/8-1	145	39	1.3	0.095	2930668	8000 AE 1
19-60	3/4-2.3/8	183	57	1.8	0.180	2923602	8000 AE 2
40-100	1.5/8-4	230	68	2.3	0.310	2930676	8000 AE 3
85-140	3.3/8-5.1/2	332	95	3.2	0.590	2930684	8000 AE 4

# 8000 AE 01 - AE 41 CIRCLIP PLIERS FOR EXTERNAL RETAINING RINGS

**NEW**

Form B

- > For safety rings as per DIN 471, DIN 983
- > DIN 5254 Form B
- > 90° angled jaws
- > Inside-positioned opening spring
- > Pliers basic body in GEDORE chrome-vanadium special steel
- > Pressed-in tips of highly wear-resistant roller bearing steel
- > Twisting-impeding tip geometry
- > Screwed joint connection
- > Steel-grey with red-dipped anti-slip handles



● mm	● inch	L	L <sub>2</sub>	d	⚖ kg	Code	No.
3-10	5/32-3/8	133	27	0.9	0.090	2930692	8000 AE 01
10-25	3/8-1	133	27	1.3	0.095	2930706	8000 AE 11
19-60	3/4-2.3/8	170	44	1.8	0.180	2930714	8000 AE 21
40-100	1.5/8-4	217	54	2.3	0.310	2930730	8000 AE 31
85-140	3.3/8-5.1/2	311	74	3.2	0.590	2930749	8000 AE 41

# 8000 A 0G - A 2G CIRCLIP PLIERS FOR EXTERNAL RETAINING RINGS

- > For shafts without groove
- > For retaining rings Seeger as well as Benzing
- > Similar to DIN 5254 Form A
- > A 0G - A 1G = tips angled 30°
- > A 2G = straight tips
- > With opening spring and adjusting screw to limit opening
- > High degree of assembly reliability, the limit opening rules out any over-tensioning of the smallest of retaining rings
- > Forged GEDORE chrome-vanadium special hardened and tempered steel
- > Precision machined, oil hardened and annealed
- > Black, with red dipped handles

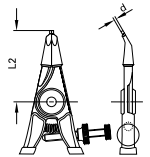
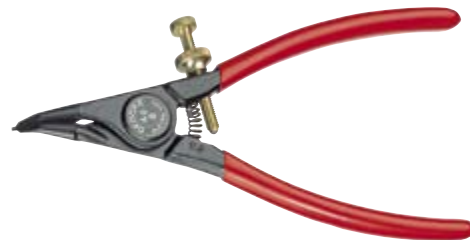

for Seeger circlips ● mm	for Benzing clamping circlips ● mm	L	L <sub>2</sub>	d	⚖ kg	Code	No.
1,5-3,5	1,5-3,5	140	40	0.7	0.099	6700140	8000 A 0G
4,0-9,0	3,0-11,0	140	40	1.1	0.098	6700220	8000 A 1G
10,0-15,0	12,0-16,0	182	57	1.8	0.189	6700300	8000 A 2G

# 8000 A 01G - A 21G CIRCLIP PLIERS FOR EXTERNAL RETAINING RINGS

- > For shafts without groove
- > For retaining rings Seeger as well as Benzing
- > Similar to DIN 5254 Form B
- > 90° angled tips
- > With opening spring and adjusting screw to limit opening
- > High degree of assembly reliability, the limit opening rules out any over-tensioning of the smallest of retaining rings
- > Forged GEDORE chrome-vanadium special hardened and tempered steel
- > Precision machined, oil hardened and annealed
- > Black, with red dipped handles

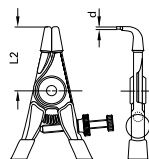
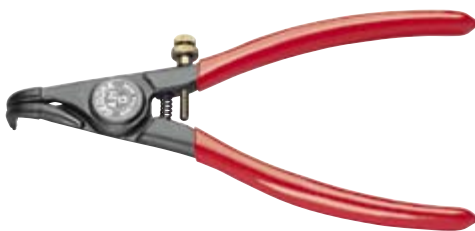

for Seeger circlips ● mm	for Benzing clamping circlips ● mm	L	L <sub>2</sub>	d	⚖ kg	Code	No.
1,5-3,5	1,5-3,5	134	33	0.7	0.100	6700650	8000 A 01G
4,0-9,0	3,0-11,0	134	33	1.1	0.099	6700730	8000 A 11G
10,0-15,0	12,0-16,0	170	45	1.8	0.184	6700810	8000 A 21G

# 8000 A 0 - A 4 CIRCLIP PLIERS FOR EXTERNAL RETAINING RINGS

Form A

- > For retaining rings as per DIN 471, DIN 983
- > DIN 5254 Form A
- > Straight tips
- > With opening spring
- > With clamping protection
- > Forged GEDORE chrome-vanadium special hardened and tempered steel
- > Precision machined, oil hardened and annealed
- > Black, with red dipped handles

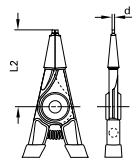
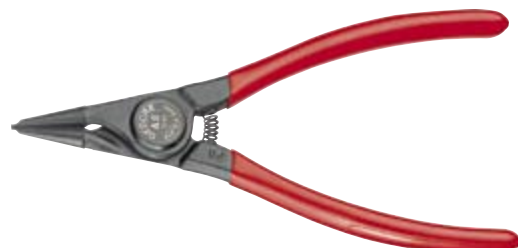

● mm	● inch	L	L <sub>2</sub>	d	⚖ kg	Code	No.
3-10	5/32-3/8	141	40.0	0.9	0.096	6701380	8000 A 0
10-25	3/8-1	141	40.0	1.3	0.098	6701460	8000 A 1
19-60	3/4-2.3/8	182	54.0	1.8	0.186	6701540	8000 A 2
40-100	1.5/8-4	230	69.0	2.3	0.310	6701620	8000 A 3
85-140	3.3/8-5.1/2	320	85.5	3.2	0.555	6701700	8000 A 4



## 8000 A 01 - A 41

### CIRCLIP PLIERS FOR EXTERNAL RETAINING RINGS



Form B

- > For retaining rings as per DIN 471, DIN 983
- > DIN 5254 Form B
- > 90° angled tips
- > With opening spring
- > With clamping protection
- > Forged GEDORE chrome-vanadium special hardened and tempered steel
- > Precision machined, oil hardened and annealed
- > Black, with red dipped handles

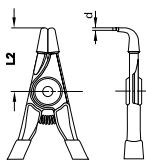
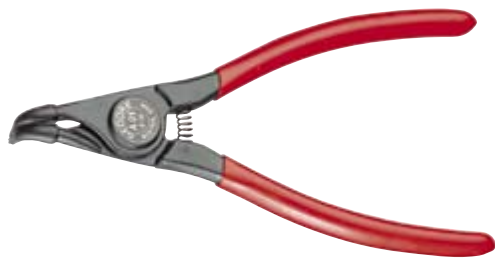

● mm	● inch	L	L <sub>1</sub>	d	⚖ kg	Code	No.
3-10	5/32-3/8	130	29	0.9	0.097	6702270	8000 A 01
10-25	3/8-1	130	29	1.3	0.097	6702350	8000 A 11
19-60	3/4-2.3/8	170	43	1.8	0.182	6702430	8000 A 21
40-100	1.5/8-4	210	53	2.3	0.317	6702510	8000 A 31
85-140	3.3/8-5.1/2	305	64	3.2	0.563	6702780	8000 A 41

## 8000 A 02 - A 42

### CIRCLIP PLIERS FOR EXTERNAL RETAINING RINGS



- > Similar to DIN 5254 Form B
- > 45° angled tips
- > With opening spring
- > With clamping protection
- > Forged GEDORE chrome-vanadium special hardened and tempered steel
- > Precision machined, oil hardened and annealed
- > Black, with red dipped handles



● mm	● inch	L	L <sub>1</sub>	d	⚖ kg	Code	No.
3-10	5/32-3/8	139	38.0	0.9	0.097	2015021	8000 A 02
10-25	3/8-1	139	38.0	1.3	0.097	2015048	8000 A 12
19-60	3/4-2.3/8	179	51.0	1.8	0.182	2015056	8000 A 22
40-100	1.5/8-4	226	65.0	2.3	0.317	2015064	8000 A 32
85-140	3.3/8-5.1/2	315	80.5	3.2	0.568	2015072	8000 A 42

## 8000 A 4 - A 6

### CIRCLIP PLIERS FOR EXTERNAL RETAINING RINGS



- > Straight tips
- > Black, tips and lock lever zinc-plated
- > The toothed bracket stops the pliers legs from straddling beyond the permitted working area
- > This ensures safe working even in hidden fitting positions
- > Locking pin can be replaced
- > Non-crush type release-lever with handle recesses, red dip-insulated
- > Precision machined, oil hardened and annealed
- > E-8000 A = pair of spare tips

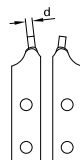

● mm	● inch	d	↳ mm	⚖ kg	Code	No.
85-140	3.3/8-5.1/2	3.2	550	1.921	2011778	8000 A 4 EL
122-300	4.13/16-11.7/8	3.5	550	1.921	6701890	8000 A 5
252-400	9.15/16-15.13/16	4.5	586	1.922	6701970	8000 A 6

d	⚖ kg	Code	No.
3.2	0.072	2011670	E-8000 A 4 EL
3.5	0.072	5701840	E-8000 A 5
4.5	0.112	5701920	E-8000 A 6

## 8000 A 41 - A 61

### CIRCLIP PLIERS FOR EXTERNAL RETAINING RINGS



- > 90° angled tips
- > Tips and lock lever zinc-plated
- > Lever handle-end red dip-insulated
- > Finger protection
- > Reinforced safety arms
- > Precision machined, oil hardened and annealed
- > E-8000 A = pair of spare tips

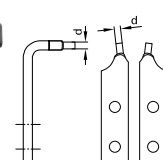

● mm	● inch	d	↳ mm	⚖ kg	Code	No.
85-140	3.3/8-5.1/2	3.2	560	1.898	2011786	8000 A 41 EL
122-300	4.13/16-11.7/8	3.5	560	1.898	6702860	8000 A 51
252-400	9.15/16-15.13/16	4.5	585	1.953	6718430	8000 A 61

d	⚖ kg	Code	No.
3.2	0.072	2011697	E-8000 A 41 EL
3.5	0.112	5702810	E-8000 A 51
4.5	0.140	5701760	E-8000 A 61

5 8028

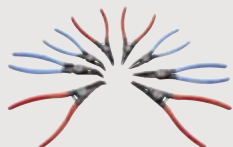

>425

1500 ES-8000



>103

Circlip pliers for internal retaining rings (bores)

**NEW**

**8000 JE 0 - JE 4**  
CIRCLIP PLIERS FOR  
INTERNAL RETAINING RINGS



Form C

- > For safety rings as per DIN 472, DIN 984
- > DIN 5256 Form C
- > Straight jaws
- > Pliers basic body in GEDORE chrome-vanadium special steel
- > Pressed-in tips of highly wear-resistant roller bearing steel
- > Twisting-impeding tip geometry
- > Screwed joint connection
- > Steel-grey with blue-dipped anti-slip handles



Ø mm	Ø inch	L	L <sub>2</sub>	d	⚖️	Code	No.
8-13	3/8-9/16	139	41	0.9	0.090	2930757	8000 JE 0
12-25	3/8-1	139	41	1.3	0.090	2930765	8000 JE 1
19-60	3/4-2.3/8	182	54	1.8	0.160	2930773	8000 JE 2
40-100	1.5/8-4	230	68	2.3	0.280	2930781	8000 JE 3
85-140	3.3/8-5.1/2	324	86	3.2	0.550	2930803	8000 JE 4

**NEW**

**8000 JE 01 - JE 41**  
CIRCLIP PLIERS FOR  
INTERNAL RETAINING RINGS



Form D

- > For safety rings as per DIN 472, DIN 984
- > DIN 5256 Form D
- > 90° angled jaws
- > Pliers basic body in GEDORE chrome-vanadium special steel
- > Pressed-in tips of highly wear-resistant roller bearing steel
- > Twisting-impeding tip geometry
- > Screwed joint connection
- > Steel-grey with blue-dipped anti-slip handles



Ø mm	Ø inch	L	L <sub>2</sub>	d	⚖️	Code	No.
8-13	3/8-9/16	129	30	0.9	0.090	2930811	8000 JE 01
12-25	3/8-1	129	30	1.3	0.090	2930838	8000 JE 11
19-60	3/4-2.3/8	170	43	1.8	0.160	2930846	8000 JE 21
40-100	1.5/8-4	217	53	2.3	0.280	2930854	8000 JE 31
85-140	3.3/8-5.1/2	310	70	3.2	0.550	2930862	8000 JE 41

**8000 J 0 - J 4**  
CIRCLIP PLIERS FOR  
INTERNAL RETAINING RINGS



Form C

- > For retaining rings as per DIN 472, DIN 984
- > DIN 5256 Form C
- > Straight tips
- > Forged GEDORE chrome-vanadium special hardened and tempered steel
- > Precision machined, oil hardened and annealed
- > Black, with blue dipped handles

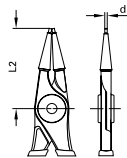

Ø mm	Ø inch	L	L <sub>2</sub>	d	⚖️	Code	No.
8-13	3/8-9/16	141	41.0	0.9	0.080	6703240	8000 J 0
12-25	3/8-1	141	41.0	1.3	0.081	6703320	8000 J 1
19-60	3/4-2.3/8	183	54.0	1.8	0.164	6703400	8000 J 2
40-100	1.5/8-4	230	68.0	2.3	0.281	6703590	8000 J 3
85-140	3.3/8-5.1/2	322	84.5	3.2	0.472	6703670	8000 J 4

**8000 J 01 - J 41**  
CIRCLIP PLIERS FOR  
INTERNAL RETAINING RINGS



Form D

- > For retaining rings as per DIN 472, DIN 984
- > DIN 5256 Form D
- > 90° angled tips
- > Forged GEDORE chrome-vanadium special hardened and tempered steel
- > Precision machined, oil hardened and annealed
- > Black, with blue dipped handles

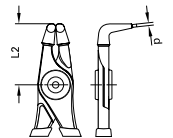

Ø mm	Ø inch	L	L <sub>2</sub>	d	⚖️	Code	No.
8-13	3/8-9/16	129	28	0.9	0.080	6704130	8000 J 01
12-25	3/8-1	129	28	1.3	0.082	6704210	8000 J 11
19-60	3/4-2.3/8	169	41	1.8	0.161	6704480	8000 J 21
40-100	1.5/8-4	214	50	2.3	0.279	6704560	8000 J 31
85-140	3.3/8-5.1/2	292	65	3.2	0.484	6704640	8000 J 41

1500 CT1-8000



>111

# 8000 J 02 - J 42

## CIRCLIP PLIERS FOR INTERNAL RETAINING RINGS



- > Similar to DIN 5256 Form D
- > 45° angled tips
- > Forged GEDORE chrome-vanadium special hardened and tempered steel
- > Precision machined, oil hardened and annealed
- > Black, with blue dipped handles

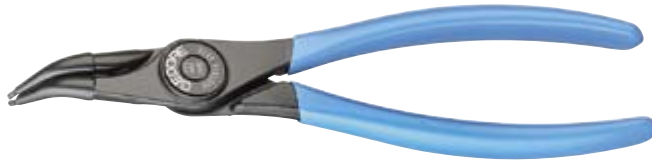

Ø mm	Ø inch	L	L <sub>2</sub>	d	⚖️	Code	No.
8-13	3/8-9/16	139	39.0	0.9	0.080	2014963	8000 J 02
12-25	3/8-1	139	39.0	1.3	0.080	2014971	8000 J 12
19-60	3/4-2.3/8	180	52.0	1.8	0.161	2014998	8000 J 22
40-100	1.5/8-4	226	64.0	2.3	0.279	2015005	8000 J 32
85-140	3.3/8-5.1/2	316	78.5	3.2	0.484	2015013	8000 J 42

# 8000 J 4 - J 6

## CIRCLIP PLIERS FOR INTERNAL RETAINING RINGS

- > Straight tips
- > Black, tips and lock lever zinc-plated
- > The toothed bracket stops the pliers legs from straddling beyond the permitted working area
- > This ensures safe working even in hidden fitting positions

- > Locking pin can be replaced
- > Non-crush type release-lever with handle recesses, blue dip-insulated
- > Precision machined, oil hardened and annealed
- > E-8000 J = pair of spare tips

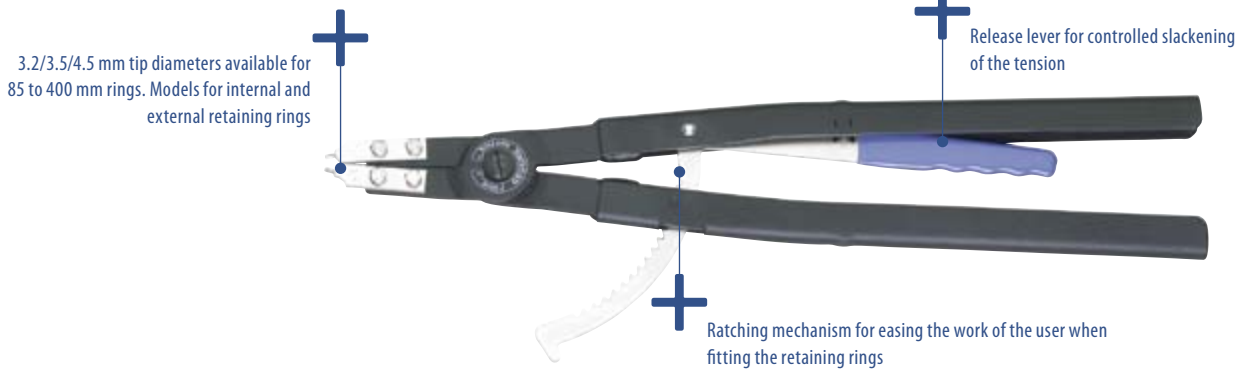

# 8000 J 4 - J 6

## CIRCLIP PLIERS FOR INTERNAL RETAINING RINGS



# 8000 J 41 - J 61

## CIRCLIP PLIERS FOR INTERNAL RETAINING RINGS



- > 90° angled tips
- > Black, tips and lock lever zinc-plated
- > Lever handle-end blue dip-insulated
- > Finger protection
- > Reinforced safety arms
- > Precision machined, oil hardened and annealed
- > E-8000 J = pair of spare tips

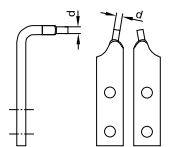
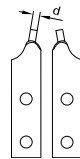

Ø mm	Ø inch	d	↳ mm ↳	⚖️	Code	No.
85-140	3.3/8-5.1/2	3.2	565	1.835	2011794	8000 J 4 EL
122-300	4.13/16-11.7/8	3.5	565	1.836	6703750	8000 J 5
252-400	9.15/16-15.13/16	4.5	575	1.846	6703830	8000 J 6

d	⚖️	Code	No.
3.2	0.072	2011700	E-8000 J 4 EL
3.5	0.072	5703700	E-8000 J 5
4.5	0.082	5703890	E-8000 J 6

Ø mm	Ø inch	d	↳ mm ↳	⚖️	Code	No.
85-140	3.3/8-5.1/2	3.2	575	1.953	2011808	8000 J 41 EL
122-300	4.13/16-11.7/8	3.5	575	1.953	6704720	8000 J 51
252-400	9.15/16-15.13/16	4.5	579	1.934	6718510	8000 J 61

d	⚖️	Code	No.
3.2	0.072	2011719	E-8000 J 41 EL
3.5	0.116	5704780	E-8000 J 51
4.5	0.116	5702730	E-8000 J 61



## Circlip pliers for retaining rings (parallel)

# 8005 A PLIERS FOR EXTERNAL RETAINING RINGS

- > For shafts
- > Supplied with four different clamping tips

- > The circlip is securely clamped before removal by choosing a suitable distance between the clamping tips. This means that unnecessary plier movement is avoided, and the circlip may be opened completely. The special parallel movement of the clamping tips and their recesses in the direction of the pressure applied ensure that the circlip will be clamped firmly.



## 8005 A CIRCLIP PLIERS FOR EXTERNAL RETAINING RINGS



mm	ε mm	mm	mm	kg	Code	No.
305-500	4.5	5,9	665	3.520	6707150	8005 A

## E-8005 A SPARE TIPS

for external retaining rings (per piece)

### Selection aid:

- > The spacing of holes for non-tensioned circlips is normally between 20 mm and 50 mm
- > The tips used to spread the rings are fitted to match the opening width of the non-tensioned circlip
- > Opening widths 18-28 mm:  
Combination tips E-8005 1 A and E-8005 2 A
- > Opening widths 29-39 mm:  
Combination tips E-8005 1 A and E-8005 4 A
- > Opening widths 40-50 mm:  
Combination tips E-8005 3 A and E-8005 4 A

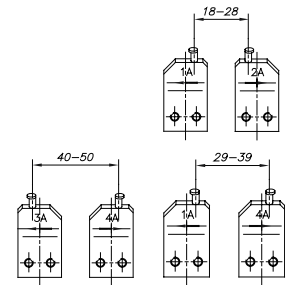

kg	Code	No.	kg	Code	No.
0.068	5700790	E-8005 1 A	0.068	5702300	E-8005 3 A
0.068	5702220	E-8005 2 A	0.068	5702490	E-8005 4 A

## E-8005 J SPARE TIPS

for internal retaining rings (per piece)

### Selection aid:

- > The spacing of holes for non-tensioned circlips is normally between 80 mm and 140 mm
- > The tips used to spread the rings are fitted to match the opening width of the non-tensioned circlip
- > Opening widths 140-125 mm:  
Combination tips E-8005 1 J and E-8005 2 J
- > Opening widths 125-110 mm:  
Combination tips E-8005 1 J and E-8005 4 J
- > Opening widths 110-95 mm:  
Combination tips E-8005 3 J and E-8005 4 J
- > Opening widths 95-80 mm:  
Combination tips E-8005 5 J and E-8005 6 J

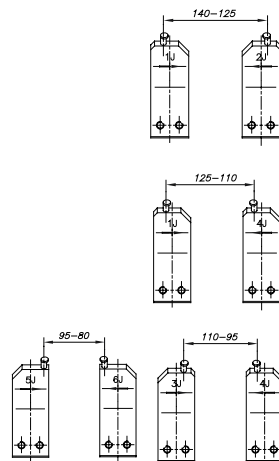

kg	Code	No.	kg	Code	No.
0.116	5703380	E-8005 1 J	0.116	5703620	E-8005 5 J
0.116	5703460	E-8005 2 J	0.116	5703970	E-8005 6 J
0.116	5704190	E-8005 3 J			
0.113	5703540	E-8005 4 J			

## 8005 J CIRCLIP PLIERS FOR INTERNAL RETAINING RINGS

- > For bores
- > Supplied with six different clamping tips
- > The circlip is securely clamped before removal by choosing a suitable distance between the clamping tips. This means that unnecessary plier movement is avoided, and the circlip may be opened completely. The special parallel movement of the clamping tips and their recesses in the direction of the pressure applied ensure that the circlip will be clamped firmly.



mm	ε mm	mm	mm	kg	Code	No.
305-500	4.5	5,9	705	3.885	6707230	8005 J

## Circlip pliers X-GRIP

### 8006 X-GRIP

#### Particularly versatile:

- > Universal circlip pliers for risk-free gripping and fitting of internal and external circlips (DIN 471/472) from 252 to 1000 mm diameter
- > Particularly suited for working in confined spaces. Instead of using a long lever, the required force is transmitted by a threaded spindle. This ensures safe, fatigue-free gripping. Operated by a 15 mm open ended spanner or a 3/8" ratchet (e.g. 3093 Z-94)
- > Solid, hardened sliding bar ensures parallel tip action
- > Stop lugs reliably prevent circlips slipping off
- > Quick changeover between internal and external circlips by rotating tips through 180°
- > Tips made from tempering steel, carefully hardened and annealed, easy to replace

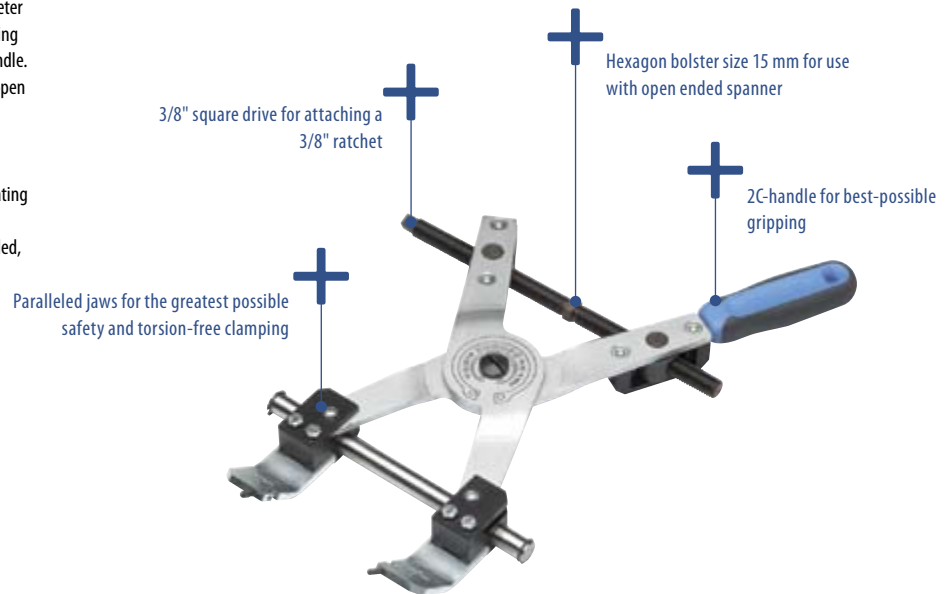

## 8006 X-GRIP CIRCLIP PLIERS

mm	mm	mm		Code	No.
252-1000	4.5	5,9	3.040	1394401	8006

## S 8006 X-GRIP CIRCLIP PLIERS SET

- > Universal circlip pliers for risk-free gripping and fitting of internal and external circlips (DIN 471/472) from 252 to 1000 mm diameter
- > Plier with adaptor, basic body - no. 1/2 + tip Ø 5.9 mm and no. 3/4 + tip Ø 4.5 mm

#### Special tools for changing tips and adaptors:

- > Single open ended spanner no. 894 10 + 894 15
- > Hexagon socket key no. 42 2 mm
- > 4 Spare threaded pins M4x4
- > Ratchet no. 3093 Z-94 (for quick adjustment)
- > Plastic box E-1000 P
- > Rugged sheet steel case with foam insert



	Code	No.
7.3	1896237	S 8006

## E-8006 X-GRIP PARTS

Description		Code	No.
<b>Basic body no. 1 with spare tip 5.9 mm Ø</b>	0.080	1575333	E-8006 1
<b>Basic body no. 2 with spare tip 5.9 mm Ø</b>	0.080	1575341	E-8006 2
<b>Basic body no. 3 with spare tip 4.5 mm Ø</b>	0.117	1896245	E-8006 3
<b>Basic body no. 4 with spare tip 4.5 mm Ø</b>	0.117	1896253	E-8006 4
<b>Spare tip 4.5 mm Ø</b>	0.005	1896369	E-8006 X 4,5
<b>Spare tip 5.9 mm Ø</b>	0.005	1896350	E-8006 X 5,9
<b>Spindle with spindle bearing, 265 mm long</b>	0.470	1910620	E-8006 X

## Grip Wrenches

# THE TOGGLE LEVER - A GIANT AMONG THE JOINTS

- > Similar in construction to the human leg and consisting of hip, knee and ankle joints
- > The knee joint's intelligent power management is its unbeatable advantage:
- > Clever utilization of the physical lever laws \*)
- > Rapid and powerful even with a reduced operating force
- > Ideal for optimum pressure and clamping operations
- > Maximum pressing/clamping force with knee lever extended – even with automatic locking effect i.e. self-clamping effect (e.g. with grip pliers) relieved by operating the releasing lever
- > Constant high quality of work

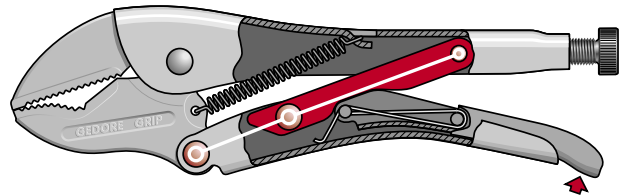
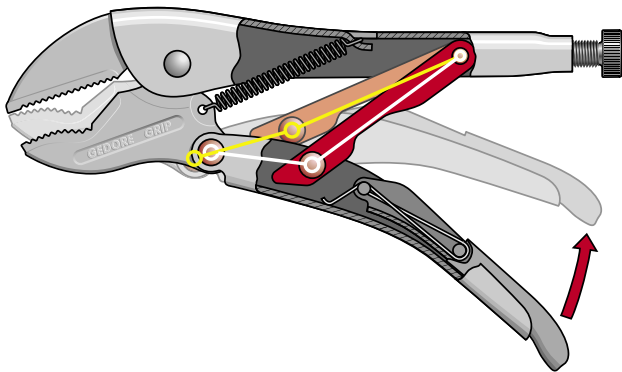

Self-clamping effect – can only be cancelled by operating the releasing lever!

\*) Considerable paths are rapidly bridged involving little hand power. Just before "stretching", a short path is covered with an exceptional lever force. That is why it is used everywhere where considerable paths need to be initially covered without any noticeable force used and where the real "work" needs to be done over the last few millimetres. This is the case, for instance, with bolt cutters and crimping/grip pliers.

## 137 GRIP WRENCH

- > With adjusting screw and release lever, model 137 10 with blue dip-insulated lever
- > Forged, tempered jaws and special jaw shape for secure gripping, clamping and holding
- > GEDORE vanadium steel 31CrV3, nickel-plated
- > Jaw body in high-tensile sheet steel
- > Automatically welded upper jaw - absolutely firm connection with the sheet steel body
- > Well-conceived jaw design guarantees a three-point contact with all material cross-sections
- > Threaded bore welded at bottom
- > No widening under most extreme loading
- > Safe release
- > Release lever under constant pressure of special spring



137



137 10

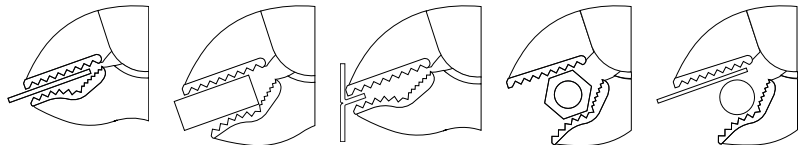

↳ mm ↵	↳ "inch ↵	mm ↵	"inch ↵	↵ kg	Code	No.
185	7	25	1	0.288	6406620	137 7
230	10	32	1.1/4	0.526	6406700	137 10
260	11	45	1.3/4	0.790	6407270	137 11
300	12	45	1.3/4	1.042	6406890	137 12

1500 ES-137



> 103

# 137 GRIP WRENCH

The difference comes from the special profile and shape.

› Positive fit joint to the screw/nut is down to the special design of the plier jaw\*

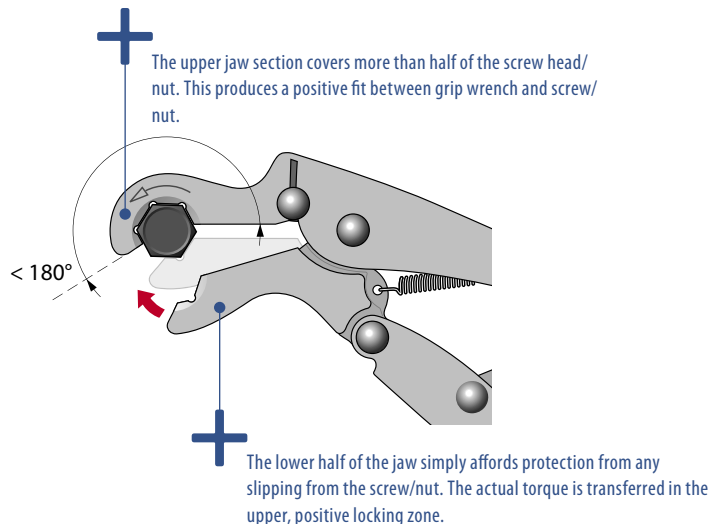

## GEDORE

- › Off-centre hexagonal division
- › positive fit

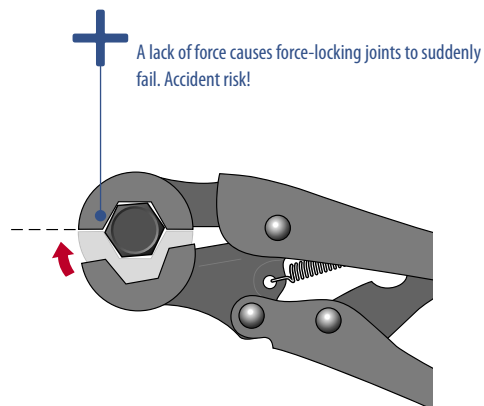

## COMPETING COMPANY

- › Centre hexagonal division
- › force locking

\* Positive fit joints are not suddenly released. They need, in fact, to change their geometric form; a visible change in form quasi announces their failure.



## A GEDORE SAFETY "EXTRA"

# 137 GRIP WRENCH

- › For working in confined spaces
- › For worn bolted connections which otherwise could only be opened with extreme difficulty

- › Problem-solver for vehicles and industrial purposes
- › Particularly suitable for brake lines, adjustment of track rods, etc.



Ø mm	Ø AF	l< mm >l		Code	No.
10		190	0.324	2325314	137 7-10
11	7/16	190	0.321	2325322	137 7-11
12		195	0.329	2325330	137 7-12
13		195	0.326	2325349	137 7-13
14		198	0.343	2325357	137 7-14
15	19/32	198	0.346	2325365	137 7-15
16	5/8	250	0.591	2325373	137 10-16
17		250	0.587	2325381	137 10-17

Ø mm	Ø AF	l< mm >l		Code	No.
18		255	0.607	2325403	137 10-18
19	3/4	255	0.600	2325411	137 10-19
20	25/32	258	0.623	2325438	137 10-20
21		258	0.620	2325446	137 10-21
22		260	0.630	2325454	137 10-22
24		253	0.642	2788349	137 10-24
27		258	0.645	2788357	137 10-27

## 139 SPECIAL GRIP WRENCH

- > With movable lower jaw for clamping over a large area
- > Release lever blue dip-insulated
- > Nickel-plated



↳ mm	↳ inch	mm	inch	kg	Code	No.
250	10	45	1.3/4	0.577	6407940	139

## 137 KR GRIP WRENCH, LONG JAWS

- > With narrow jaws
- > For working in confined spaces
- > For clamping air and brake lines up to Ø 10 mm, copper lines Ø 12 mm
- > Nickel-plated



↳ mm	kg	Code	No.
210	0.292	1954113	137 KR-7
255	0.540	1868039	137 KR-10

## 137 P PARALLEL JAW GRIP WRENCH

- > With parallel jaws
- > Opening: 50 mm
- > With adjustment screw
- > Release lever under constant pressure of special spring
- > Body from sheet steel
- > Nickel-plated



↳ mm	↳ inch	mm	inch	kg	Code	No.
250	10	50	2	0.701	6407000	137 P

## 137 MSP MACHINE WORKBENCH CLAMP

- > For fast, secure clamping of a variety of workpieces
- > Suitable for tenon blocks threaded M8, M10 or M12
- > GEDORE special vanadium steel, nickel-plated
- > Release lever blue dip-insulated
- > Tenon block not included

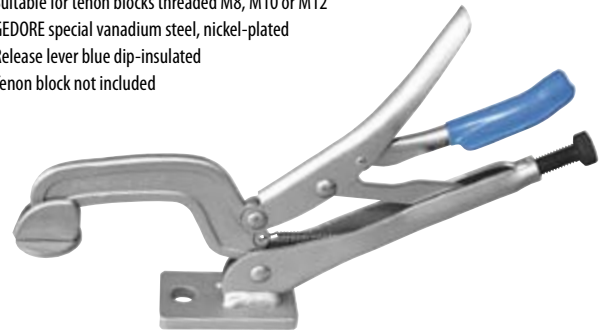

↳ mm	↳ inch	mm	inch	kg	Code	No.
280	11	100	4	0.790	6408080	137 MSP

## 136 BM WIDE JAW GRIP WRENCH

- > For clamping edges and surfaces
- > 80 mm jaw width
- > Nickel-plated



↳ mm	↳ inch	mm	inch	kg	Code	No.
200	8	30	1.1/4	0.416	6406030	136 BM

## 137 T GRIP WRENCH FOR GLUEING

- > For clamping lengthwise or corner joints of extremely long bases and surrounds, lintels, banisters and frames, arched windows, worktops, corner benches, etc.
- > Release lever blue dip-insulated
- > Nickel-plated
- > The workpieces to be glued are placed

together, with the grip open, the drill holes for the clamping pins are marked, and 9 - 10 mm Ø holes drilled. Glue is applied, the wrench pushed into the holes, the pieces aligned and the clamping lever closed - the work is finished



↳ mm	↳ inch	mm	inch	kg	Code	No.
220	9	30-60	1.1/4-2.1/2	0.494	6403600	137 T



# 138 WELDER'S GRIP WRENCH

- > For clamping strips and profile sections when welding
- > Cast steel jaws

- > Nickel-plated
- > Release lever blue dip-insulated

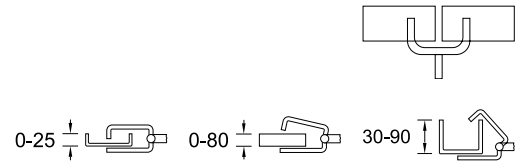

mm	inch	kg	Code	No.
280	11	0.960	6407350	138

# 138 X WELDER'S GRIP WRENCH FOR TUBES

- > For clamping tubes and round stock when welding
- > Cast steel jaws

- > Nickel-plated
- > Release lever blue dip-insulated

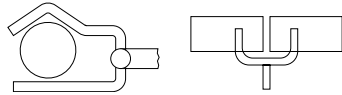
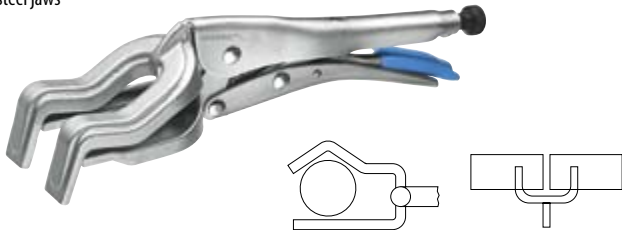

mm	inch	mm	inch	kg	Code	No.
280	11	10-90	3/8-3.1/2	0.967	6407510	138 X

# 138 Y PROFILE-SECTION GRIP WRENCH

- > For clamping bulky profile and angle sections
- > Strong forged jaws

- > GEDORE special chrome-vanadium steel, nickel-plated
- > Release lever blue dip-insulated



mm	inch	mm	inch	mm	inch	kg	Code	No.
280	11	95	3.3/4	75	3	0.763	6407860	138 Y

# 138 Z PROFILE-SECTION GRIP WRENCH

- > For clamping extremely bulky profile sections
- > Jaws made from forged and welded GEDORE special chrome-vanadium steel
- > Particularly great clamping depth
- > Nickel-plated
- > Release lever blue dip-insulated



mm	inch	mm	inch	mm	inch	kg	Code	No.
460	18	280	11	250	10	1.164	6410730	138 Z-460
600	24	400	16	400	16	1.428	6410810	138 Z-600

# 136 K CHAIN GRIP WRENCH

- > Particularly suited for clamping geometrically problematical cross-sections
- > With No. 136 K-105 the legs of various pullers - following locking - can be spanned with the chain at the component to be extracted and tightened. This stops the legs bending outwards and slipping. Pulling is still possible even if the legs have a very restricted contact surface

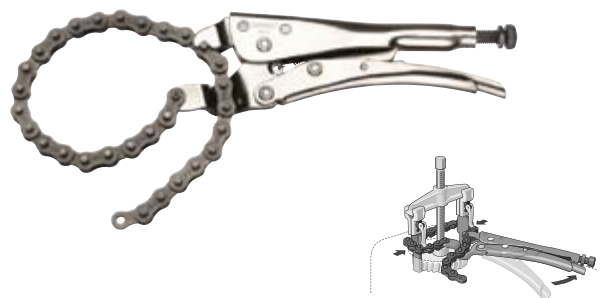

max. Ø	mm	kg	Code	No.
330	1050	1.5	2307227	136 K-105



# GEDORE PIPE WRENCHES

## TOP QUALITY TO MEET MAXIMUM REQUIREMENTS

- › Use of the most up-to-date machinery and environmentally-friendly production processes
- › Everything is based on tightly controlled and selected materials
- › Experienced and reliable specialists vouch for precision-like processing
- › Stringent quality checks after each production step ensure a constantly high level
- › High-grade industrial quality for the toughest forms of continuous use and safety in everyday work

### Everything handled down to a tee

The absence of Chrome 6 in the tools is simply a matter of course for us and has been so for many years. Best-possible results are down to the unique manufacturing processes and special treatment for tools

### Pipe wrenches subject to full hardening/tempering

All GEDORE Swedish pipe wrenches **are hardened and tempered** across their entire length and cross-section.

### Serrated face flame-hardening

All GEDORE Swedish pipe wrenches are additionally flame-hardened at the teeth by a hardness unit developed by our Special Machinery Construction section. A uniform distribution of temperature across the entire jaw surface ensures a stress-relieved additional hardening of the surface of the teeth. The DIN specified hardness values are surpassed with ease by GEDORE pipe wrenches. The grip holds up for years even under the rough and tough daily routine.

### Round thread with undetachable adjusting nut

A non-detachable adjusting nut with round thread ensures a width adjustment. A round thread stands up better than other thread types to mechanical damage and soiling. It allows the adjusting nut on the pliers shaft to run rapidly, evenly and precisely.

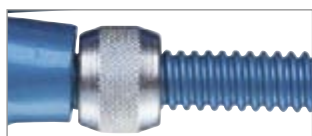

### Self-clamping serrated face

The self-clamping serrated face grips reliably and firmly and this is intensified as the turning resistance is increased. There is no need to press the handles together. GEDORE Swedish pipe wrenches have that non-slip grip - even on smooth pipes.



# ECK-SCHWEDE-SNAP® - THE SWEDISH

Tried and tested bestseller with a powerful grip for more than 50 years



(1) The special, supplementary flame hardening of the teeth increases and improves the grip and durability of the snap®

(2) Force is always applied by snap® simultaneously at three points, ensuring a secure grip with low hand pressure

(3) Hook and leg made from drop-forged GEDORE special chrome-vanadium steel, hardened and tempered

(4) Stove enamelling guarantees long-life protection

(5) The mouth of the jaw opening is always narrower than the pipe diameter, reliably preventing the workpiece from slipping out. Securely grips pipes and screw couplings

## WORKING PRINCIPLE



The jaw form of the snap® reliably prevents the workpiece slipping out, and ensures maximum freedom of movement in confined spaces

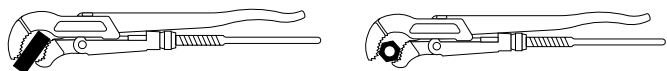



The curvature of the jaws adapts ideally to different profiles, enabling the snap® to grip hexagonal nuts - gently and securely

## 100 PIPE WRENCH ECK-SCHWEDE-SNAP®

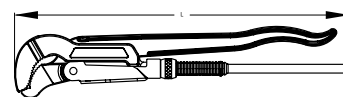
- > Acc. to DIN 5234, Form C
- > Heavy-duty pipe wrench with three-point grip
- > For working in confined spaces
- > GEDORE special chrome-vanadium steel
- > Drop forged
- > Tempered, teeth additionally hardened
- > Self-gripping by teeth offset against direction of rotation
- > Roller secured against loss
- > Stove enamelled blue, head ground



Size	mm 	L		Code	No.
1/2	35	245	0.380	4500060	100 1/2
1	48	320	0.800	4500140	100 1
1.1/2	60	420	1.400	4500220	100 1.1/2
2	80	550	2.240	4500300	100 2
3	110	630	3.580	4500490	100 3

## 175 PIPE WRENCH

Swedish pattern

- > Acc. to DIN 5234 Form A
- > Especially sturdy type for heavy use
- > Head angled 85°
- > GEDORE special chrome-vanadium steel
- > Drop forged
- > Tempered, teeth additionally hardened
- > Self-gripping by teeth offset against direction of rotation
- > Roller secured against loss
- > Stove enamelled blue

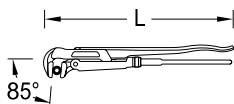

Size	mm	L		Code	No.
3/4	38	280	0.505	6437260	175 3/4
1	44	320	0.695	6437340	175 1
1.1/2	62	430	1.470	6437420	175 1.1/2
2	76	580	2.550	6437500	175 2
3	105	670	3.780	6437690	175 3
4	130	760	5.635	6437770	175 4

## 176 ELBOW PIPE WRENCH ECK-SCHWEDE®

- > Acc. to DIN 5234 Form B
- > For working in confined spaces
- > Narrow head, multi-grip jaw pattern, angled 52°
- > GEDORE special chrome-vanadium steel
- > Drop forged
- > Tempered, teeth additionally hardened
- > Self-gripping by teeth offset against direction of rotation
- > Roller secured against loss
- > Stove enamelled blue

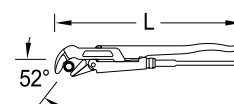

Size	mm	L		Code	No.
3/4	38	280	0.445	6438070	176 3/4
1	44	320	0.775	6438150	176 1
1.1/2	62	430	1.405	6438230	176 1.1/2
2	76	580	2.570	6438310	176 2
3	105	670	3.640	6438580	176 3

## 9100 2K PIPE WRENCH

- > Acc. to DIN 5234, Form C
- > For working in confined spaces
- > GEDORE special chrome-vanadium steel
- > Drop forged
- > Tempered, teeth additionally hardened
- > Self-gripping by teeth offset against direction of rotation

- > Non-slip surfaces, in sizes 1" and 1.1/2" with 2-component handles
- > Roller secured against loss
- > Stove enamelled blue



1 / 1.1/2



1/2 / 2 / 3

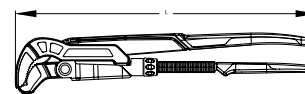
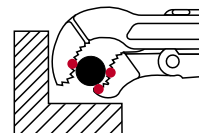
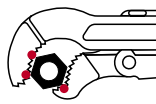
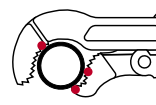
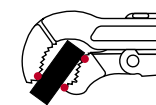

Size	2C-handle	mm	L		Code	No.
1/2		35	245	0.400	2530252	9100 2K 1/2
1	X	48	320	0.800	2530260	9100 2K 1
1.1/2	X	60	420	1.400	2530279	9100 2K 1.1/2
2		80	550	2.200	2530287	9100 2K 2
3		110	630	3.600	2530295	9100 2K 3



## E-100 / E-175 / E-9100 SET OF SPARES

- > A = Roller / Adjuster screw
- > B = Circlip



No. 100	No. 175	No. 176	No. 9100		Code	No.
1/2				0.010	2133792	E-100 A 1/2
1	1			0.030	1682938	E-100 A 1
1.1/2	1.1/2			0.040	1737597	E-100 A 1.1/2
2 + 3	2			0.070	1628984	E-100 A 2
	3/4	3/4		0.010	5435000	E-175 A 3/4
	1			0.030	5435190	E-175 A 1
	1.1/2			0.040	5435270	E-175 A 1.1/2

No. 100	No. 175	No. 176	No. 9100		Code	No.
2				0.070	5435350	E-175 A 2
3	3			0.070	5435430	E-175 A 3
4				0.080	1391607	E-175 A 4
			1/2	0.003	2601028	E-9100 A 1/2
			1	0.010	2601273	E-9100 A 1
			1.1/2	0.012	2601281	E-9100 A 1.1/2
			2 + 3	0.025	2601311	E-9100 A 2
1/2	3/4 + 1	3/4	1/2	0.001	5436240	E-100 B 1/2
1	1.1/2	1	1	0.002	5436400	E-100 B 1
1.1/2	2	1.1/2	1.1/2	0.001	5436590	E-100 B 1.1/2
2 + 3	3 + 4	2 + 3	2 + 3	0.020	5436670	E-100 B 2

## 225 PIPE WRENCH

NEW

- > Stillson type
- > Hot-drop forged
- > Forged parts tempered
- > Self-gripping by teeth offset against direction of rotation
- > GEDORE special hardened and tempered steel



L mm	L" inch	mm	"inch	Ø"inch		Code	No.
250	10	33.5	1.3/8	1	0.480	2964813	225 10
300	12	42.0	1.3/4	1.1/4	0.680	2964821	225 12
350	14	48.0	1.7/8	1.1/2	0.940	2964848	225 14
450	18	60.0	2.3/8	2	1.550	2964856	225 18
600	24	75.5	3	2.1/2	2.480	2964864	225 24
900	36	102.0	4	3.1/2	4.820	2964872	225 36

## 227 PIPE WRENCH

American pattern

- > Extra heavy type
- > Forged parts tempered
- > Teeth offset against direction of rotation and induction-hardened
- > Handle made from malleable cast iron, stove enamelled
- > GEDORE special hardened and tempered steel, ground



L mm	L" inch	mm	"inch	Ø"inch		Code	No.
190	8	38	1.1/2	1	0.440	6453030	227 8
245	10	48	1.7/8	1.1/2	0.850	6453110	227 10
325	14	60	2.3/8	2	1.751	6453460	227 14
415	18	76	3	2.1/2	2.701	6453540	227 18
560	24	89	3.1/2	3	4.280	6453620	227 24

## 152 HIGH-SPEED PIPE WRENCH

with screw adjuster

- > GEDORE blue powder-coated
- > Forged components
- > Induction-rehardened serrated faces

- > Quick and easy setting with screw adjuster - single-hand adjustment
- > Gripping faces selfinhbiting

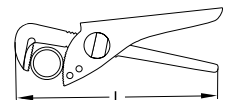

L	L"	mm	"inch	Pipes	Sockets		Code	No.
178	7	35	1.3/8	1"	3/4"	0.300	6419280	152 7
228	9	42	1.5/8	1.1/4"	1"	0.531	6419360	152 9
281	11	61	2.3/8	2"	1.3/4"	0.851	6419440	152 11

L	L"	mm	"inch	Pipes	Sockets		Code	No.
315	12	74	3	2.1/2"	2"	1.038	6419520	152 12
360	14	90	3.9/16	3"	-	1.656	6419600	152 14

## Water Pump / Universal Pliers

142  
UNIVERSAL PLIERS

- > Acc. to DIN ISO 8976 Form C
- > With safety box joint and protection against blocking
- > Fine adjustment
- > 142 7 = 17 settings
- > 142 10 = 15 settings
- > 142 12 = 17 settings
- > Single-hand push-button adjustment
- > Slender pliers head for places that are hard to access
- > Long slim jaws
- > Offset gripping faces for self-gripping of nuts and pipes
- > GEDORE special chrome-vanadium steel
- > Induction-rehardened serrated faces
- > Model C = slim handles with forged serrations
- > Model TL = steel-grey, with blue dipped handle protectors
- > Model JC = chrome-plated, with 2-component handles



L <sub>1</sub>	L <sub>2</sub>	b	h	mm	kg	Code	No.	L <sub>1</sub>	L <sub>2</sub>	b	h	mm	kg	Code	No.
180	32	6.5	40	37	0.183	2668211	142 7 TL	260	39	7.5	48	38	0.417	6416340	142 10 JC
180	32	6.5	40	37	0.173	2668238	142 7 C	309	43	8.5	55	44	0.550	1995413	142 12 TL
255	39	7.5	48	38	0.371	6416180	142 10 TL	300	43	8.5	55	44	0.530	1995553	142 12 C
250	39	7.5	48	38	0.380	6416260	142 10 C								

143  
UNIVERSAL PLIERS

6 settings

- > Acc. to DIN ISO 8976 Form B
- > Slim head
- > Forged twin-groove lay-on slip joint and toothed recess
- > Offset gripping faces for self-gripping of nuts and pipes
- > With finger protection
- > For pipes up to 1.1/2" and nuts up to 38 mm
- > GEDORE special chrome-vanadium steel, chrome-plated
- > Induction-rehardened serrated faces
- > Model C = slim handles with forged serrations
- > Model JC = chrome-plated, with 2-component handles

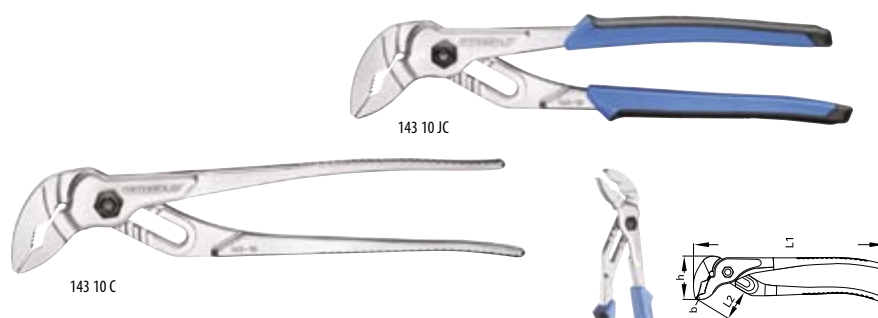

L <sub>1</sub>	L <sub>2</sub>	b	h	mm	kg	Code	No.
256	40	10.6	56	38	0.340	6410650	143 10 C
262	40	10.6	56	38	0.390	6415880	143 10 JC

144  
MECHANICS PLIERS

7 settings

- > Acc. to DIN ISO 8976 Form A
- > Lay-on slip joint and straight, serrated jaws
- > GEDORE special chrome-vanadium steel
- > Induction-rehardened serrated faces



L <sub>1</sub>	L <sub>2</sub>	b	h	mm	kg	Code	No.
113	13	3.8	23	16	0.042	6411110	144 4.1/2 C
175	22	5.5	35	26	0.138	6411380	144 7 C

# 145 WATER PUMP PLIERS

- > Acc. to DIN ISO 8976 Form A
  - > Lay-on slip joint and toothed recess
  - > Induction-rehardened serrated faces, with finger protection
  - > Clamps automatically on pipes and nuts
  - > GEDORE special chrome-vanadium steel, chrome-plated
- > Model C = handles cross-hatched
  - > Model JC = with 2-component handles
  - > 145 10 = 7 settings, with extra narrow jaws
  - > 145 15 = 9 settings
  - > 145 20 = 11 settings

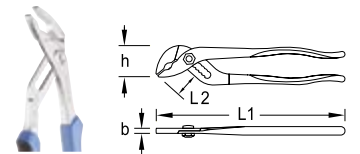

L <sub>1</sub>	L <sub>2</sub>	b	h	mm		Code	No.
250	41	7.8	47	39	0.365	6412000	145 10 C
260	41	7.8	47	39	0.425	6415610	145 10 JC
375	46	10.4	72	50	0.854	6412190	145 15 C
500	55	13.8	98	65	1.747	6412270	145 20 C

# 146 UNIVERSAL PLIERS

7 settings

- > Acc. to DIN ISO 8976 Form C
  - > With safety box joint and finger protection
  - > Automatic clamping with offset gripping surfaces
  - > GEDORE special chrome-vanadium steel, chrome-plated, with polished surface
- > Induction-rehardened serrated faces
  - > Model C = slim handles with forged serrations
  - > Model JC = chrome-plated, with 2-component handles

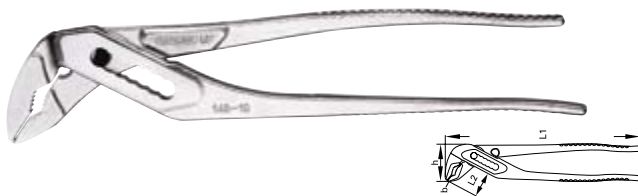

L <sub>1</sub>	L <sub>2</sub>	b	h	mm		Code	No.
250	32.5	4.8	48	31	0.335	6413240	146 10 C
250	32.5	4.8	48	31	0.400	2672626	146 10 JC

# 146 B SPECIAL WATER PUMP PLIERS

5 settings

- > Acc. to DIN ISO 8976 Form C
  - > With fast adjustment and tooth-lock box joint and toothed aperture
  - > Absolutely safe - no slipping out of adjustment during work
- > With finger protection
  - > GEDORE special chrome-vanadium steel, chrome-plated, polished



L <sub>1</sub>	L <sub>2</sub>	b	h	mm		Code	No.
250	45	8	55	50	0.485	6412510	146 B 10

# 9144 WATER PUMP PLIERS

- > Acc. to DIN ISO 8976
- > Chrome-vanadium steel
- > With box joint
- > Drop forged

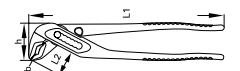

L <sub>1</sub>	L <sub>2</sub>	b	h	mm		Code	No.
175	28	7.0	33	26	0.150	4533230	914417
240	35	7.5	40	33	0.290	4533310	914424
300	40	9.0	60	45	0.480	4533580	914430



## Chain Pipe Wrenches

### 120 CHAIN PIPE WRENCH BOSS

- > Ideal for use in areas with restricted access
- > Ratchet-type operation
- > Plastic grip prevents hand from slipping off
- > Handle in GEDORE special chrome-vanadium steel



- > Drop forged
- > Tempered, teeth additionally hardened
- > Stove enamelled blue

### E 120 SPARE CHAIN BOSS



Size	Ø mm	l mm	W kg	Code	No.
3/8-4	17-114	355	0.840	4502350	120000

l mm	W kg	Code	No.
450	0.320	4535280	120200

### 122 CHAIN PIPE WRENCH

American pattern

- > High efficiency due to maximum-possible lever action
- > Tempered steel acc. to EN 10083
- > With hardened exchangeable jaws, toothed on both sides
- > Stove enamelled blue



### E 122 SPARE CHAIN



Size	l mm	W kg	Code	No.
1/8-2	380	0.725	4548500	122202
1/4-3	490	0.950	4548690	122203
3/4-4	610	1.410	4548770	122204
1-6	850	2.200	4548850	122206
1.1/2-8	1080	3.300	4548930	122208
2-12	1450	5.740	4549070	122212

### E 122 SPARE JAWS (PAIR)



Size	Ø mm	l inch	l mm	W kg	Code	No.
1/8-2	10-60	20	510	2.5	4535360	122002
1/4-3	13-89	28	710	4.0	4535440	122003
3/4-4	27-114	37	940	6.6	4502430	122004
1-6	33-168	43	1090	9.1	4502510	122006
1.1/2-8	48-219	50	1275	13.0	4548340	122008
2-12	60-324	63	1600	22.1	4548420	122012

Size	W kg	Code	No.
1/8-2	0.340	4549150	122302
1/4-3	1.030	4549230	122303
3/4-4	1.520	4549310	122304
1-6	2.100	4549580	122306
1.1/2-8	2.640	4549660	122308
2-12	4.450	4549740	122312



## Special Pliers

### 8385 WIRE TWISTING PLIERS

- > For twisting and cutting
- > GEDORE special hardened and tempered steel, gun-metal finish
- > Angled by 45°
- > Extra narrow head shape
- > Cross-hatched gripping face for better "wire grip"
- > Twists wires from 0.5 to 1.6 mm Ø
- > Clockwise or counterclockwise twisting, adjustable by turning handle
- > Automatic resetting
- > Cutting edge with FOD (= No Foreign Object Damage). The special red plastic coating securely holds the rest of the cut wire. This rules out the wire being accidentally lost.



mm	inch	kg	Code	No.
229	9	0.400	1979957	8385

### 8386 CONNECTOR PLIERS

- > With lap joint
- > 3 settings
- > Protects sensitive surfaces
- > Particularly suitable for Canon-Connectors or other screw connectors
- > Plastic jaws bolted and replaceable (No. E-8386), jaw width 11 mm
- > GEDORE high-performance hardened and tempered steel, chrome-plated
- > Handles dip-insulated



mm	kg	Code	No.
20-60	0.300	2003481	8386
	0.010	2003694	E-8386

### 304 SEAMING PLIERS

straight pattern

- > Straight pattern
- > Forged



mm	mm	kg	Code	No.
60	265	0.590	4508550	304060

### 305 SEAMING PLIERS

bent pattern

- > Bent pattern, bending angle 45°
- > Forged



mm	mm	kg	Code	No.
60	265	0.630	4508630	305060

## Bolt Cutters

### 8340 / 8340 Z BOLT CUTTERS



- > Compact power bolt cutter with a particularly effective cutting performance
- > Optimum lever action requires less effort
- > Wear-free rotating/thrust block bolt to reduce sliding friction when cutting
- > Force optimised, joint-near cutting is guaranteed

- > The effective force multiplication ratio of 1:30 results of the joint-near use of the cutting edge
- > Here the lever ratio of hand to cutting force is optimal
- > A gliding ahead from this cutting position is prevented by the micro-grooves resp. the additional cutting edge

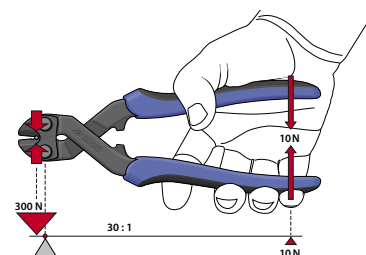

#### 8340

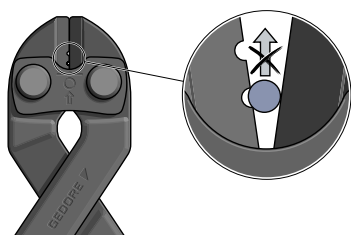

- > With a cut soft, medium-hard or hard wires up to 4 mm Ø are separated
- > The gliding ahead of the cutting material is prevented by two one-sided micro-grooves and thus is always stays in optimal cutting position

#### 8340 Z

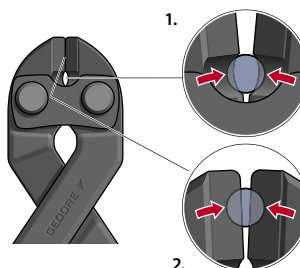

- > With two cuts soft, medium-hard or hard wires from 4 to 6 mm Ø are separated
- > The extra cutting edge (1) serves as first cut for thick bolts and engraves them deeply
- > In the second step, the main cutting edge (2) cuts through the bolt completely

### 8340 BOLT CUTTER

- > Compact power bolt cutter with a particularly effective cutting performance
- > Optimum lever action requires less effort
- > Wear-free rotating/thrust block bolt to reduce sliding friction when cutting
- > Cutting edges additionally inductively hardened (63 - 65 HRC)
- > The gliding ahead of the cutting material is prevented by two one-sided micro-grooves and thus is always stays in optimal cutting position
- > Precision cutting edges for soft wire up to Ø 6.0 mm, hard and piano wire up to Ø 3.8 mm
- > Model JL = steel-grey
- > Model TL = steel-grey, with blue dipped handle protectors

### 8340 Z BOLT CUTTER

- > Compact power bolt cutter with a particularly effective cutting performance
- > Optimum lever action requires less effort
- > Wear-free rotating/thrust block bolt to reduce sliding friction when cutting
- > Cutting edges additionally inductively hardened (63 - 65 HRC)
- > Double-sided recess cutting with extra cutting edge, near the joint, ensures optimum lever conditions for large wire diameters
- > The extra cutting edge serves as first cut for thick bolts and engraves them deeply
- > In the second step, the main cutting edge cuts through the bolt completely
- > Precision cutting edges for soft wire up to Ø 6.0 mm, hard wire up to Ø 5.5 mm and piano wire up to Ø 3.8 mm
- > Model JL = steel-grey
- > Model TL = steel-grey, with blue dipped handle protectors



8340-200 JL



8340 Z-200 JL



8340-200 TL



8340 Z-200 TL

l - mm ▶	kg	Code	No.
200	0.389	2541300	8340-200 JL
200	0.338	2541289	8340-200 TL

l - mm ▶	kg	Code	No.
200	0.389	2666324	8340 Z-200 JL
200	0.338	2666316	8340 Z-200 TL



## 8178 BOLT CUTTER

- > Acc. to DIN ISO 5743
- > Double cam bolt adjustment
- > Cutting head replaceable
- > Cutting heads from chrome-vanadium steel
- > Max. cutting performance 44 HRC



max. $\bullet$ mm	mm	inch	kg	Code	No.
5	460	18	1.680	2675137	8178 460
7	620	24	2.460	2675145	8178 620
8	780	30	4.700	2675153	8178 780
9	900	36	5.000	2675161	8178 900

## E-8178 SPARE CUTTING HEAD

kg	Code	No.
0.440	2675196	E-8178 460
0.800	2675218	E-8178 620
1.460	2675226	E-8178 780
1.470	2675234	E-8178 900

## 8179 CONCRETE MESH AND BOLT CUTTER

- > Acc. to DIN ISO 5743
- > Double cam bolt adjustment
- > Cutting head replaceable
- > Cutters from chrome-vanadium steel
- > Max. cutting performance in round stock 40 HRC, 9 mm or 2 x 8 mm



max. $\bullet$ mm	mm	kg	Code	No.
9/2x8	900	3.500	2675188	8179 900

## E-8179 SPARE CUTTING HEAD

kg	Code	No.
0.980	2675242	E-8179 900

### Blacksmith's tongs

## 230 BLACKSMITH'S TONGS

- > Flat nosed



mm	for workpieces	kg	Code	No.
300	6 mm	0.500	8842510	230-300
400	8 mm	0.860	8842780	230-400
500	10 mm	1.240	8842860	230-500
600	14 mm	1.710	8842940	230-600

## 231 BLACKSMITH'S TONGS

- > Round nosed



mm	for workpieces	kg	Code	No.
400	12 mm	0.870	8843590	231-400
500	16 mm	1.220	8843670	231-500

## 233 BLACKSMITH'S TONGS

- > Wolf's jaw



mm	for workpieces	kg	Code	No.
300	6 mm	0.610	8845100	233-300
400	8 - 10 mm	0.930	8845290	233-400
500	12 mm	1.320	8845370	233-500

## Plier assortments

- › Produced in-house by GEDORE Austria
- › Combination, flat-nosed, round-nosed and mechanics pliers made from GEDORE special hardened and tempered steel
- › Side cutters and end cutting nippers made from GEDORE high-performance hardened and tempered steel
- › JC = chrome-plated, 2-component handle protectors
- › TL = clear varnished, with blue dipped non-slip handles
- › Hot-forged tempered steel
- › Precision machined, oil-hardened and annealed
- › Induction-rehardened cutting edges
- › Protective nickel and chrome plating
- › Optimum transfer of force
- › High cutting performance
- › Fatigue-free, even in constant use
- › Guaranteed GEDORE quality

### S 8003 JC PLIERS SET

3 pieces

- › Practical set composition in environmentally-friendly cardboard box
- › JC = chrome-plated, with 2-component handles





### S 8003 TL PLIERS SET

3 pieces

- › Practical set composition in environmentally-friendly cardboard box
- › TL = steel-grey, with blue dipped non-slip handles



Contents		Code	No.
8132-160 JC	0.766	6701110	S 8003 JC
8250-180 JC			
8316-160 JC			

Contents		Code	No.
8132-160 TL	0.642	6755470	S 8003 TL
8250-180 TL			
8316-160 TL			

#### VDE S 8003 H

›587



#### VDE S 8003

›587



## S 8200 JC PLIERS SET

4 pieces

- > Practical set composition in environmentally-friendly cardboard box
- > JC = chrome-plated, with 2-component handles



Contents		kg	Code	No.
8098-160 JC	8250-180 JC	0,927	6730800	S 8200 JC
8132-160 JC	8314-160 JC			

## S 8303 JC PLIERS SET

3 pieces

- > Practical set composition in environmentally-friendly cardboard box
- > JC = chrome-plated, with 2-component handles



Contents	kg	Code	No.
142 10 JC	1.005	6703160	S 8303 JC
8250-180 JC			
8316-160 JC			

## S 8303 TL PLIERS SET

3 pieces

- > Practical set composition in environmentally-friendly cardboard box
- > TL = steel-grey, with blue dipped non-slip handles



Contents	kg	Code	No.
142 10 TL	0.880	6703910	S 8303 TL
8250-180 TL			
8316-160 TL			

1101-142-2150

>59



1102 L

>63





# 1101-002 PLIERS SET

**NEW**

6 pieces

- > Practical set composition in sturdy plastic case
- > JC = chrome-plated, with 2-component handles
- > In GEDORE i-BOXX® 72 no. 1101 L
- > Dimensions: W 367 x D 316 x H 72 mm



Contents		kg	Code	No.
8098-160 JC	8132-160 JC	1,740	1708155	1101-002
8120-160 JC	8250-180 JC			
8122-160 JC	8316-180 JC			

# 1102-003 PLIERS SET

**NEW**

3 pieces

- > Practical set composition
- > JC = chrome-plated, with 2-component handles
- > In GEDORE L-BOXX® Mini, incl. divider set
- > Dimensions: W 260 x D 155 x H 63 mm



Contents		kg	Code	No.
8132-160 JC		0,940	1692305	1102-003
8250-180 JC				
8316-160 JC				

# 1102-007 PLIERS SET

**NEW**

3 pieces

- > Practical set composition
- > In GEDORE L-BOXX® Mini, incl. divider set
- > Dimensions: W 260 x D 155 x H 63 mm



Contents		kg	Code	No.
8132-200 JC		1.201	2951789	1102-007
8314-180 JC				
142 10 TL				

# 1102-008 PLIERS SET

**NEW**

3 pieces

- > Practical set composition
- > In GEDORE L-BOXX® Mini, incl. divider set
- > Dimensions: W 260 x D 155 x H 63 mm



Contents		kg	Code	No.
8316-160 JC		0.977	2951797	1102-008
8133-200 JC				
142 7 TL				



## Circlip pliers sets

### S 8000 SET OF CIRCLIP PLIERS

4 pieces

- > Most popular sizes, packed in environmentally-friendly cardboard box
- > Particularly suitable for barely accessible places
- > For internal and external circlip rings
- > With straight and 90° angled tips



Contents	kg	Code	No.
8000 A 2 A 21	0.756	6701030	S 8000
8000 J 2 J 21			



### S 8008 SET OF CIRCLIP PLIERS

8 pieces

- > Most popular sizes, packed in environmentally-friendly cardboard box
- > Particularly suitable for barely accessible places
- > For internal and external circlip rings
- > With straight and 90° angled tips



Contents	kg	Code	No.
8000 A 1 A 11 A 2 A 21	1.082	6700490	S 8008
8000 J 1 J 11 J 2 J 21			



### S 8100 SET OF CIRCLIP PLIERS

4 pieces

- > Most popular sizes, packed in environmentally-friendly cardboard box
- > Particularly suitable for barely accessible places
- > For internal and external circlip rings
- > With straight and 90° angled tips



Contents	kg	Code	No.
8000 A 1 A 2	0.597	6703080	S 8100
8000 J 1 J 2			



### S 8024 SET OF CIRCLIP PLIERS

4 pieces

- > Most popular sizes, packed in environmentally-friendly cardboard box
- > For automotive use
- > Particularly suitable for barely accessible places
- > For internal and external circlip rings
- > With straight and 45° angled tips



Contents	kg	Code	No.
8000 A 2 A 22	0.756	2148684	S 8024
8000 J 2 J 22			



# 5 8028 SET OF CIRCLIP PLIERS

8 pieces

- > Most popular sizes, packed in environmentally-friendly cardboard box
- > For automotive use
- > Particularly suitable for barely accessible places
- > For internal and external circlip rings
- > With straight and 45° angled tips



Contents		Code	No.
8000 A 1 A 2 A 12 A 22	1.082	2148692	S 8028
8000 J 1 J 2 J 12 J 22			



# 1101-001 SET OF CIRCLIP PLIERS

8 pieces

- > Usual type of tool set packed in sturdy plastic case
- > Particularly suitable for barely accessible places
- > For internal and external circlip rings
- > With straight and 90° angled tips
- > In GEDORE i-BOXX® 72, with transparent cover for getting an immediate impression
- > Dimensions: W 367 x D 316 x H 72 mm

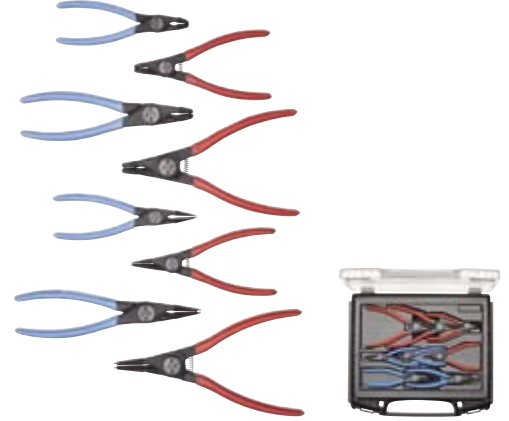

Contents		Code	No.
8000 A 1 A 11 A 2 A 21	1.550	1692275	1101-001
8000 J 1 J 11 J 2 J 21			



# 1102-001 SET OF CIRCLIP PLIERS

4 pieces

- > Usual type of tool set
- > Particularly suitable for barely accessible places
- > For internal and external circlip rings
- > With straight and 90° angled tips
- > In GEDORE L-BOXX® Mini, incl. divider set
- > Dimensions: W 260 x D 155 x H 63 mm

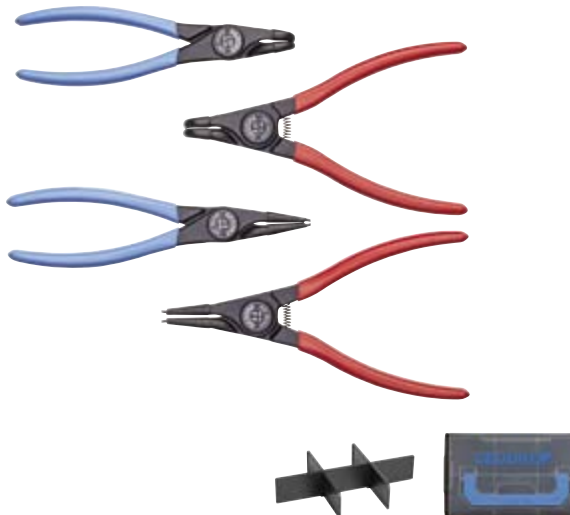

Contents		Code	No.
8000 A 2 A 21	1.220	1692283	1102-001
8000 J 2 J 21			



# 1101-004 SET OF CIRCLIP PLIERS

8 pieces

- > Particularly suitable for barely accessible places
- > With straight and 45° angled tips
- > For the safe installation and removal of internal and external retaining rings up to a size of 60 mm
- > In GEDORE i-BOXX® 72, with transparent cover for getting an immediate impression
- > Dimensions: W 367 x D 316 x H 72 mm

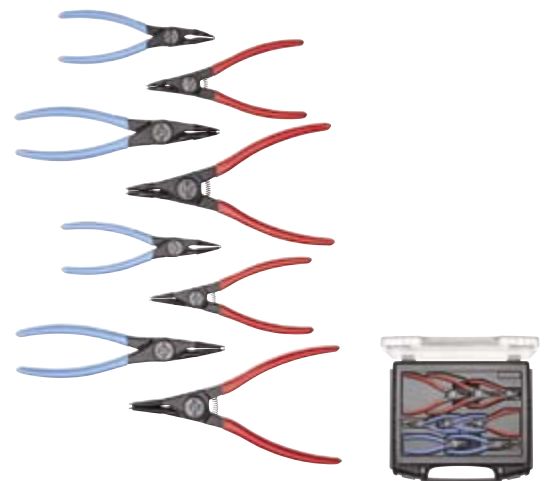

Contents		Code	No.
8000 A 1 A 12 A 2 A 22	1.550	2148706	1101-004
8000 J 1 J 12 J 2 J 22			



NEW





# PULLERS

2-/3-ARM UNIVERSAL  
EXTERNAL+INTERNAL  
PULLERS  
>433



2-/3-ARM UNIVERSAL  
EXTERNAL+INTERNAL PULLER  
SETS  
>437



SUMMARY OF PULLER LEGS  
>450



SPINDLE SUMMARY  
>452



BEARING ASSEMBLY  
>455



2-/3-ARM FAN / BATTERY-  
TERMINAL PULLERS  
>457



HYDRAULIC IMPLEMENTS  
>469



SEPARATORS  
>472



BALL BEARING EXTRACTORS  
>475



INTERNAL EXTRACTORS  
>480



SLIDING HAMMER  
>483



SPECIAL AUTOMOTIVE TOOLS  
>488



NUT SPLITTERS  
>491



THREADED INSERTS  
>492



ADD-ON SYSTEMS  
>493



# MANUFACTURING PROCESS OF A 2-ARM 1.06 PULLER

## CROSS-BEAM

**1**  
**Blank**  
from hard and tempered steel cut from the bar.



**2**  
**"Pre-upsetting"**  
Mighty hammer blows drop-forged the cut-to-length forging into the hot "pre-form".



**3**  
**Rough-forging**  
Powerful drop-hammer blows contour the cross-beam in the first die-sinking.



**4**  
**Final forging**  
The cross-beam obtains its ultimate shape in the second die-sinking.



**5**  
**De-burring**  
Excess burr is removed under an eccentric press.



**6**  
**Forged blank**  
Ready for further processing and finishing.



**7**  
**Calibrating**  
The width of the leg guide is calibrated and sand-blasted. Important for the following operations.



**8**  
**Grinding**  
Grinding the cross-beam on all sides.



**9**  
**Milling the leg guide**  
The height of the leg guide is milled to size.



**10**  
**Drilling**  
Tapped hole is drilled.



**11**  
**Cutting**  
The thread for the spindle is cut.



**12**  
**Zinc-plating**  
Electro-galvanized for corrosion protection.



**13**  
**Stamping**  
Manufacturer and Item No. are stamped on in a permanent fashion.



**14**  
**Lasering**  
The check-tool marking is lasered.



## SPINDLE

**1**  
**Blank**  
from hard and tempered steel cut from the bar.



**2**  
**Turning + drilling**  
Turn the spindle to measure and the drill hole for the spindle tip is inserted.



**3**  
**Rolling**  
The fine thread is rolled.



**4**  
**Nitro-carburating**  
Edge-layer hardening of the thread. The spindle is toughened at the edge and thus resistant to wear. The core remains "soft" and flexible and resiliently absorbs any stresses arising.



**5**  
**Riveting**  
Either the firm spindle tip is permanently riveted or the replaceable spindle tip inserted.





In line with the requirement, we hot-form the ideal steel for each puller sub-assembly.

## CLAMPING PARTS

**1**  
**Blank**  
made of hard and tempered steel and cut to size from the bar.



**2**  
**Upsetting**  
Mighty hammer blows drop-forged the cut-to-length forging into the hot "pre-form".



**3**  
**Rough-forging**  
Powerful drop-hammer blows contour the clamping parts in the first die-sinking.



**4**  
**Final forging**  
The clamping parts obtain their ultimate shape in the second die-sinking.



**5**  
**Hot de-burring**  
Still hot excess burr is removed under an eccentric press.



**6**  
**Forged blank**  
Ready for further processing and finishing.



**7**  
**Calibrating**  
The clamping part is calibrated and sand-blasted.



**8**  
**Perforating**  
The two holes for connection with the leg are cold-holed.



**9**  
**Zinc-plating**  
Electro-galvanizing protects the clamping part from corrosion.



**10**  
**Mounting**  
A pin and a screw and/or the quick-release clamp are for connecting two clamping parts to the leg.



## LEGS

**1**  
**Blank**  
made of 31CrV3 and cut to size from the bar.



**2**  
**Forging**  
Hot, drop-forged.



**3**  
**De-burring**  
Excess burr is removed under an eccentric press.



**4**  
**Calibrating**  
The leg is calibrated and sand-blasted.



**5**  
**Drilling**  
The holes for the clamps are drilled.



**6**  
**Milling**  
Milling provides the leg base with its optimum form.



**7**  
**Tempering**  
A special thermal treatment involving inert gas gives the leg its extreme hardness and toughness. Hardening ensures the required hardness and the annealing which follows imparts that toughness to the legs. Hardening and annealing together are referred to as tempering.



**8**  
**Sand-blasting**  
Sand-blasting is made use of to clean the surface before processing continues.



**9**  
**Zinc-plating**  
Electro-galvanizing protects the leg from corrosion.



**10**  
**Pressing-in**  
The connecting pin for the two clamping parts is pressed in.



# GEDORE PULLERS

The right tool for every demand placed

For maximum performance - even under a multi-ton load

- > High-grade industrial quality for the toughest forms of continuous use and safety in everyday work
- > Our innovative force over the past few years, which has given rise to numerous patents and utility models, is very much a reflection of our extensive track record in the development and production of puller tools.
- > Effortless moving of multi-ton loads
- > Ideal for the controlled use of force and a vital requirement for safe working: puller in association with a torque wrench

Intelligent designs - well thought-out components

- > The refined GEDORE pullers impress as much through their quality as they do through their user-friendliness and superiority in detail:
- > A lasered scale on the 2-arm cross-beam enable the legs to be symmetrically aligned
- > Leg brake and quick-release clamp are those rapid and assured ways of locking and fastening the puller legs
- > Both the nitro-carburised mechanical and hydraulic spindles have properties that make work considerably easier and safer.

Best-possible quality for your safety

- > Maximum value is attached to the safety of the puller when selecting the material and manufacturing process for each individual component part beforehand.
- > Any overloading of drop-forged components, such as 2-arm cross-beams, legs and clamping parts, is revealed through deformation - on account of the course of their fibres - rather than through fracturing and/or splintering.
- > Thermo-chemical treatment bestows a hardness on the components meeting the demands placed.
- > Strict quality checks ensure a constant high level

Flexibility and specialization

- > Irrespective as to whether the same pulling operations are repeated or whether you are confronted each time with new pulling challenges, special or flexible all-purpose pullers - saving both on time and force - are there to meet your individual demands
- > The 1.06 and 1.07 series provide that unsurpassed flexibility. 2 and 3-arm cross-beams of various sizes, legs in the most varied of shapes and lengths, various fastening systems and the scope to replace the mechanical spindle by a hydraulic one all give rise to a modular system with which you can extensively retrofit and update your puller - thus making it applicable for all sorts of pulling situations.
- > Appropriate ranges for varied fields of work - including the workshop, industry and agricultural/constructional machinery repairs.
- > From the incidental parts to the heavy-duty puller, GEDORE provides tools for external, internal and ball bearing pullers and special-purpose tools. Should you still not find the right tool, then do contact us as to possible customised manufacturing.



# YOUR PATH TO THE RIGHT PULLER

- A How can the component to be extracted be gripped?
- B Is a support possible either externally or internally?
- C Which clamping spread/reach has to be obtained?

## 1. EXTERNAL PULLING

>433

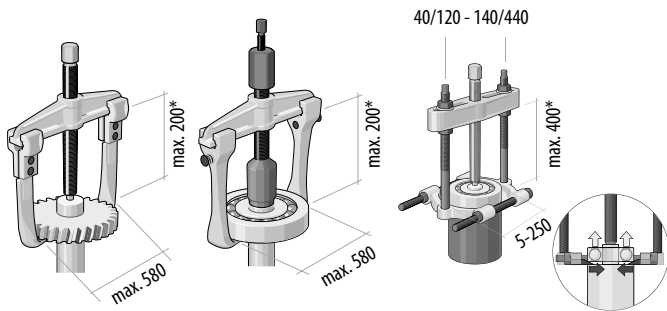

- > The component to be extracted can only be gripped externally
- > The centre axle is for supporting purposes
- > The component to be extracted is well set into, thus ruling out the use of pulling legs
- > The centre axle is for supporting purposes

## 2. INTERNAL PULLING

>480

- > The component to be extracted can only be gripped internally
- > Centre axle supporting is not possible

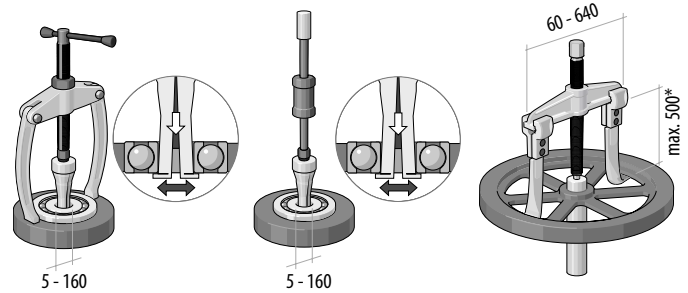

- > Supporting possible outside of the component
- > No support possible - thus the use of extracting aids
- > Centre axle supporting is possible

## 3. BALL BEARING EXTRACTION

>475

The ball bearing to be pulled is fitted on a shaft and in a housing and, as such, can neither be internally or externally gripped

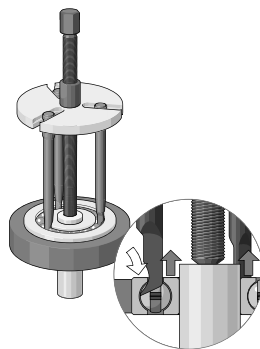

## 4. EXTRACTION USING A SPECIAL-PURPOSE TOOL

>486

- > Automotive tool for
- > Ball joints
- > Oil filters /cartridges
- > Steering wheel
- > Springs
- > Wheel hubs etc.

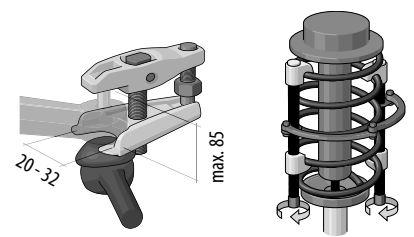

- > Supporting possible outside of the component

### SAFETY NOTES FOR PULLERS

>640

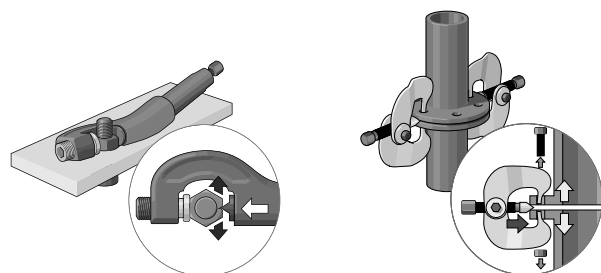
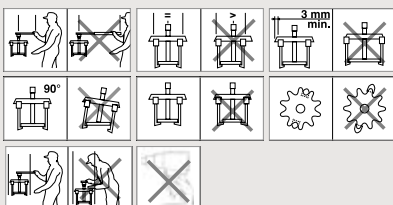

- > Nut splitters
- > Stud extractors
- > Flange separators
- > Threaded inserts



# 1.04 - A THOROUGHLY SUPERIOR TYPE OF PULLER



The legs of the 1.04 puller series have a T-profile. This ensures a positive fit between leg and cross-beam. The T-profile transfers the tensile force of the hooks via the clamping parts to the cross-beam - with no losses involved. The quick-release adjuster makes for trouble-free setting and readjustment.



Reinforced cross-beam - the additional arching at the top of the crossbar produces an H-profile which, in turn, raises the load capacity as against the flexural torque.

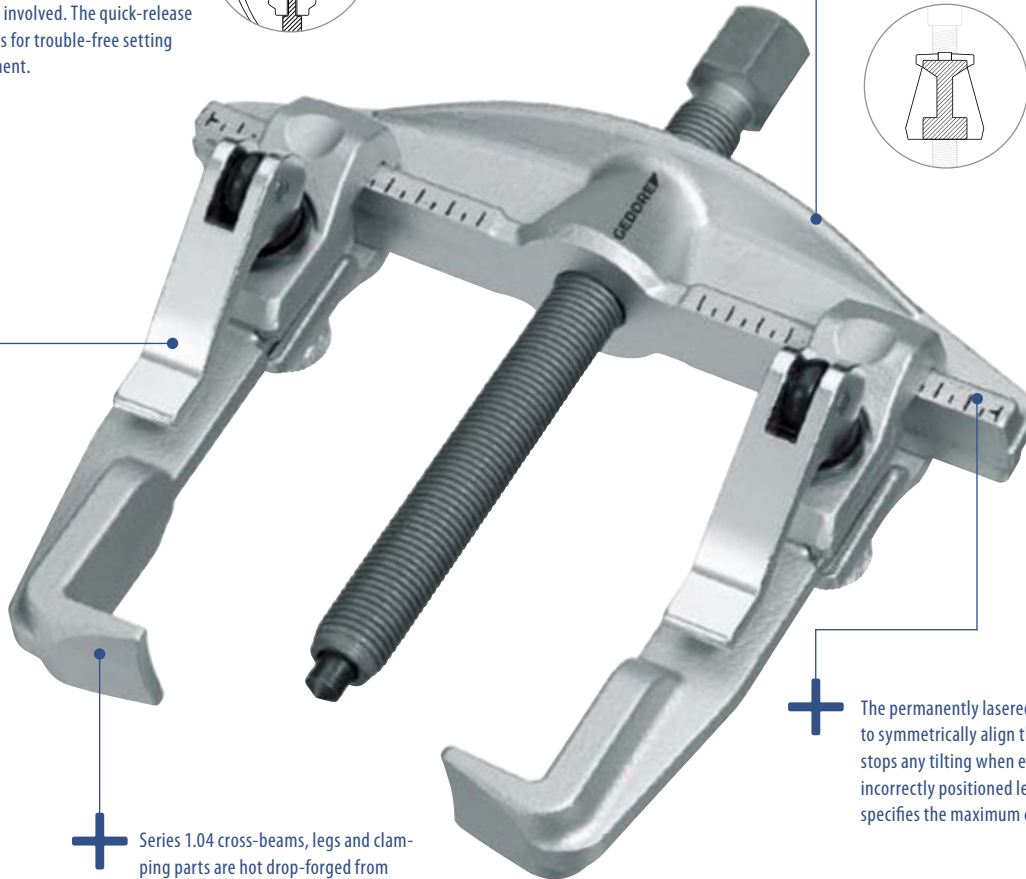
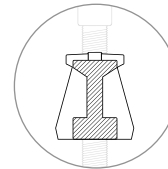

Series 1.04 cross-beams, legs and clamping parts are hot drop-forged from hardened and tempered steel, giving them all the benefits of drop-forged components.



The permanently lasered scale makes it easier to symmetrically align the legs. This effectively stops any tilting when extracting caused by incorrectly positioned legs. A final marking specifies the maximum clamping spread.

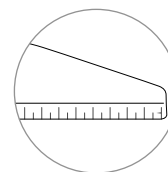

## GEDORE spindles

> Comprise turned hardened and tempered steel. The fine thread is then rolled - this additional strengthening of the steel gives rolled thread a higher strength than a thread produced by cutting.

- > Have a fine thread which stops any unintended slackening from vibrations.
- > Are thermo-chemically treated. Nitro-carburating gives the spindle a high degree of wear and corrosion resistance. Oils and greases are not needed and, as such, the thread stays clean and smooth much longer.
- > Are fitted out with a replaceable spindle tip which is equally suitable for both centred and non-centred shafts.



### Safety-relevant

Forces amounting to several tons in weight act on the puller during the extracting operation! Drop-forged components "announce" possible overloading by bending. This is due to the fibre course of the material during forging permitting a certain flexibility of the components ahead of fracturing - an extremely "healthy" property, in fact!





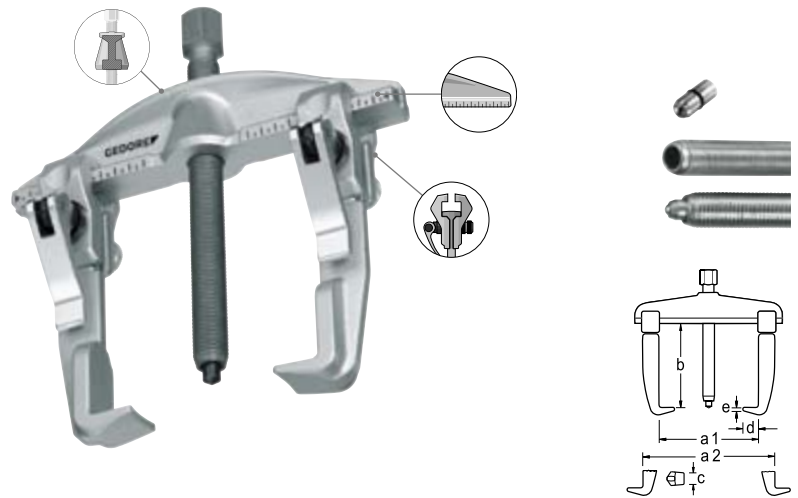

# 1.04 UNIVERSAL PULLER

## 2-arm pattern

- > For the safe and quick removal of pulleys, wheels, ball bearings, etc.
- > Strong drop forged pattern
- > Due to the bending-moment reinforcement on its back face, the energy-saving design of the cross-beam means even stronger and safer pulling work
- > Scale for uniform adjustment of the puller legs. Allows centred pulling, with optimised application of force, even when extremely high pulling forces are required
- > The quick-action adjustment feature supports the energy-saving and fast operation
- > Spindle with replaceable ball and tip point
- > Upgradeable with hydraulic spindle (see table)







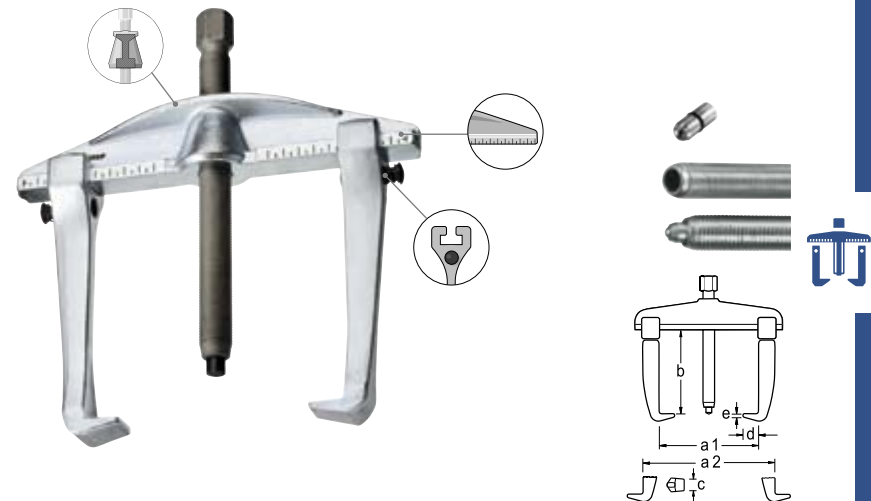

a <sub>1</sub>	a <sub>2 min</sub>	a <sub>2 max</sub>	b	max. t		optional 	c	d	e			Code	No.	
130	70	170	100	3.0	M 14x1,5 x 140	17	–	22	12	3.0	x	1.2	1307703	1.04/1A
200	110	260	150	5.0	G 1/2 x 210	22	1.06/HSP1	30	18	3.5	x	3.4	1307827	1.04/2A
350	150	420	200	7.5	G 3/4 x 280	27	1.06/HSP2	36	28	6.5	x	7.7	1307940	1.04/3A

# 1.04/B UNIVERSAL PULLER

## 2-arm pattern, rigid legs with leg brake

- > Due to the bending-moment reinforcement on its back face, the energy-saving design of the cross-beam means even stronger and safer pulling work
- > Strong drop forged pattern
- > Rigid legs forged from one piece
- > The legs clamp automatically when under tension
- > Leg brake - prevents unintentional leg slipping. The leg can be slid along the cross-beam at the push of a button
- > By reversing the legs, this tool can be used as an internal or external puller
- > Scale for uniform adjustment of the puller legs. Allows centred pulling, with optimised application of force, even when extremely high pulling forces are required
- > Spindle with replaceable ball and tip
- > Spindle thermo-chemically hardened
- > Upgradeable with hydraulic spindle (see table)



a <sub>1</sub>	a <sub>2 min</sub>	a <sub>2 max</sub>	b	max. t		 mm optional 	c	d	e			Code	No.	
130	70	170	100	3.0	M 14x1,5 x 140	17	–	22	15	3.0	x	1.2	1981110	1.04/1A-B
200	110	260	150	5.0	G 1/2 x 210	22	1.06/HSP1	30	24	3.5	x	3.4	1981129	1.04/2A-B
350	150	420	200	7.5	G 3/4 x 280	27	1.06/HSP2	36	33	5.0	x	7.7	1981137	1.04/3A-B

### SUMMARY OF PULLER LEGS



>450

# 1.04 HIGH POWER - THE POWER PACK

- Reinforced cross-beam - the additional arching at the top of the crossbar produces an H-profile which, in turn, raises the load capacity as against the flexural torque.
- In the HP version the cross-beam is additionally hardened and tempered. This brings about practically a doubling of the loading limit!

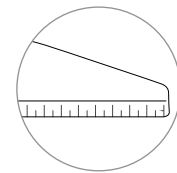
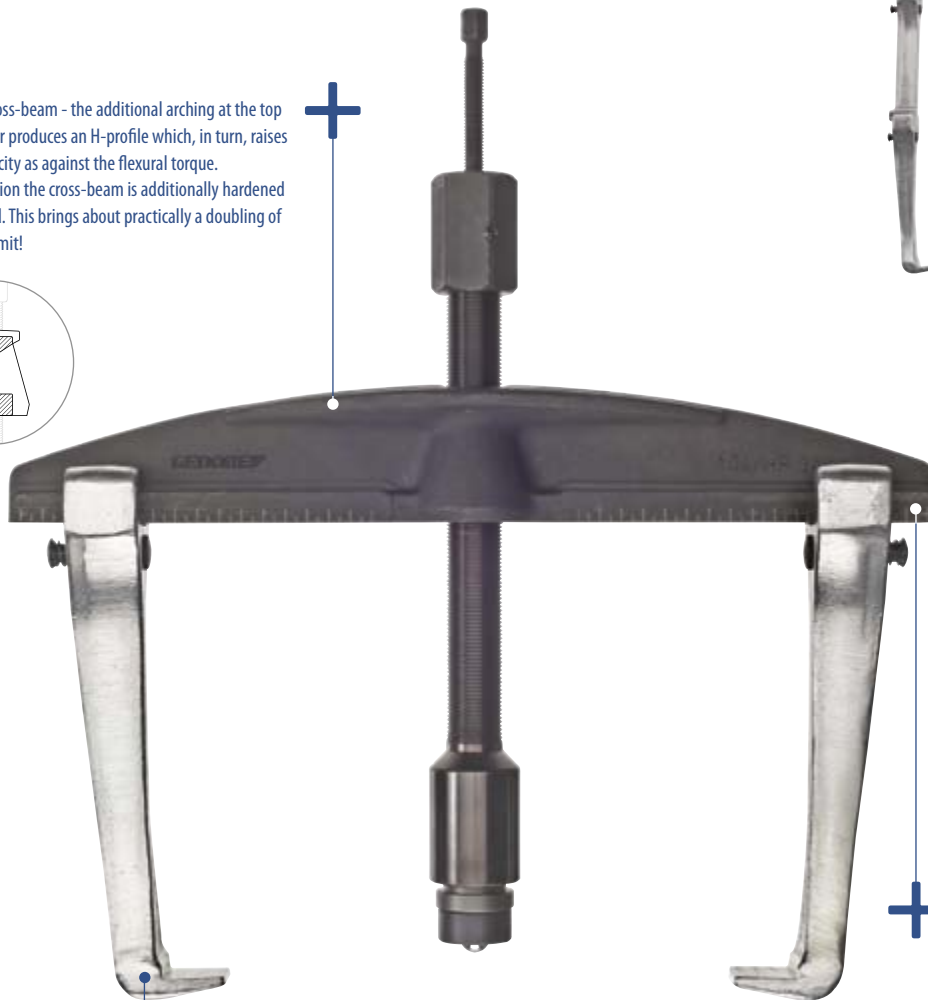
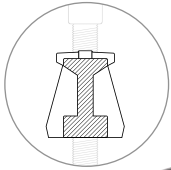

- The permanently lasered scale makes it easier to symmetrically align the legs. This effectively stops any tilting when extracting caused by incorrectly positioned legs. A final marking specifies the maximum clamping spread.

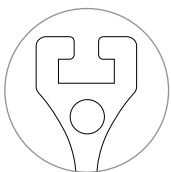

- The all-in steel legs are hot forged in one piece from 31CrV3 steel and hardened/tempered. They provide a positive-locking connection to the cross-beam.
- The leg brake secures the hooks from unintentional motions.
- Pressing the release button unlatches the locking - the leg can be moved on the cross-beam. Releasing the button causes the leg to jam tight on the cross-beam with slipping ruled out.

## Hydraulic spindles

- Hydraulic spindles simplify the work - less force and time needed for a pulling operation
- The hydraulic spindle principle is both straightforward and ingenious at the same time. The effect of screwing in the clamping bolt is to compress the grease inside the hydraulic piston - the extending piston acts on the part to be extracted with a force many times greater than that manually applied at the top.
- This controlled operation provides for working safely with the hydraulic spindle and is recommended, in particular, for high levels of force.
- In the 1.04 series a hydraulic spindle can be used upwards of puller size 2A. The pressure piece can be replaced by a tip and lengthened by 35, 85 or 135 mm. The small pressure spindle is secured with an unscrewing lock to stop any accidental withdrawal.



## Safety-relevant

Forces amounting to several tons in weight act on the puller during the extracting operation! Drop-forged components "announce" possible overloading by bending. This is due to the fibre course of the material during forging permitting a certain flexibility of the components ahead of fracturing - an extremely "healthy" property, in fact !





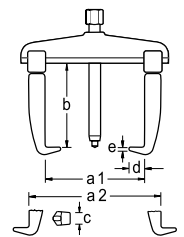
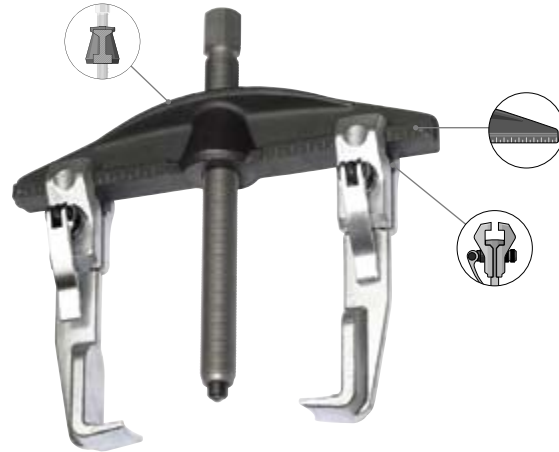

# 1.04/HP UNIVERSAL PULLER HIGH POWER

## 2-arm pattern

- > Cross-beam especially hardened and tempered allows safe application of extremely high pulling forces and doubles the tensile force capability
- > Strong drop forged pattern
- > By reversing the legs, this tool can be used as an internal or external puller
- > Scale for uniform adjustment of the puller legs. Allows centred pulling, with optimised application of force, even when extremely high pulling forces are required
- > Integral legs, with quick-release
- > Spindle with replaceable ball and tip
- > Spindle thermo-chemically hardened
- > Upgradeable with hydraulic spindle (see table)







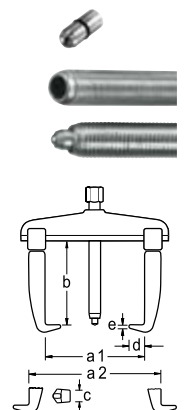
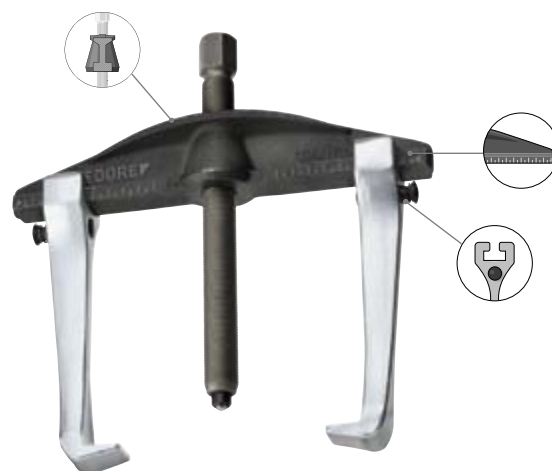

$a_1$	$a_{2\min}$	$a_{2\max}$	b	max. t		 mm optional 	c	d	e			Code	No.	
130	70	170	100	5.0	M 14x1,5 x 140	17	—	22	12	3.0	x	1.2	1868152	1.04/HP1A
200	110	260	150	10.0	G 1/2 x 210	22	1.06/HSP1	30	18	3.5	x	3.4	1868160	1.04/HP2A
350	150	420	200	15.0	G 3/4 x 280	27	1.06/HSP2	36	28	6.5	x	7.7	1868179	1.04/HP3A

# 1.04/HP-B UNIVERSAL PULLER HIGH POWER

## 2-arm pattern, rigid legs with leg brake

- > Cross-beam especially hardened and tempered allows safe application of extremely high pulling forces and doubles the tensile force capability
- > Strong drop forged pattern
- > Rigid legs forged from one piece
- > Leg brake - prevents unintentional leg slipping. The leg can be slid along the cross-beam at the push of a button
- > By reversing the legs, this tool can be used as an internal or external puller
- > Scale for uniform adjustment of the puller legs. Allows centred pulling, with optimised application of force, even when extremely high pulling forces are required
- > Upgradeable with hydraulic spindle (see table)



$a_1$	$a_{2\min}$	$a_{2\max}$	b	max. t		 mm optional 	c	d	e			Code	No.	
130	70	170	100	5.0	M 14x1,5 x 140	17	—	22	15	3.0	x	1.2	1981145	1.04/HP1A-B
200	110	260	150	10.0	G 1/2 x 210	22	1.06/HSP1	30	24	3.5	x	3.4	1981153	1.04/HP2A-B
350	150	420	200	15.0	G 3/4 x 280	27	1.06/HSP2	36	32	5.0	x	7.7	1981161	1.04/HP3A-B



# 1.04/HP-B-HSP UNIVERSAL PULLER HIGH POWER

hydraulic, 2-arm pattern, solid steel legs with leg brake

- > Cross-beam especially hardened and tempered allows safe application of extremely high pulling forces and doubles the tensile force capability
- > Strong drop forged pattern
- > Rigid legs forged from one piece
- > Leg brake - prevents unintentional leg slipping. The leg can be slid along the cross-beam at the push of a button
- > By reversing the legs, this tool can be used as an internal or external puller
- > Scale for uniform adjustment of the puller legs. Allows centred pulling, with optimised application of force, even when extremely high pulling forces are required
- > With the hydraulic spindle, a controlled and safe pulling action is possible at all times
- > Also available with standard spindle - Model 1.04/HP-B



1.04/HP3A-B-HSP2

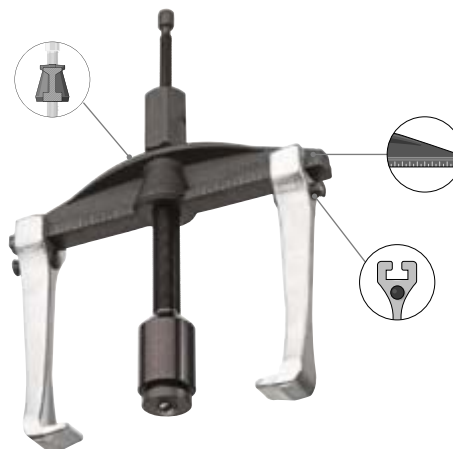

1.04/HP2A-B-HSP1

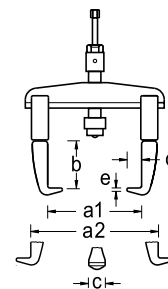

a <sub>1</sub>	a <sub>2 min</sub>	a <sub>2 max</sub>	b	max. t	max. N·m		c	d	e			Code	No.
200	110	260	70	10.0	17	1.06/HSP1	30	24	3.5	x	3.8	2016206	1.04/HP2A-B-HSP1
350	150	420	120	12.0	19	1.06/HSP2	36	32	5.0	x	7.8	2300036	1.04/HP3A-B-HSP2

# 1.04/ST PULLER SET

with stand

- > Consisting of 3 pullers each in different sizes
- > Strong drop forged pattern
- > Due to the bending-moment reinforcement on its back face, the energy-saving design of the cross-beam means even stronger and safer pulling work
- > Scale for uniform adjustment of the puller legs. Allows centred pulling, with optimised application of force, even when extremely high pulling forces are required
- > The quick-action adjustment feature supports the energy-saving and fast operation
- > Spindle with replaceable ball and tip point
- > Upgradeable with hydraulic spindle (see table)

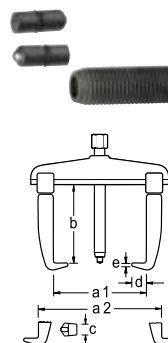
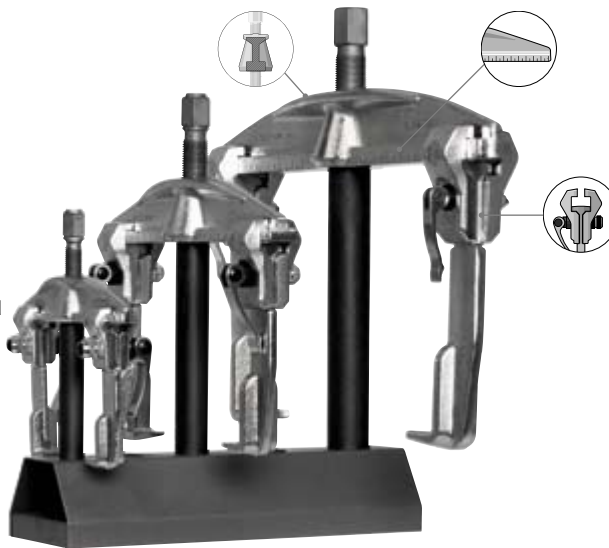

## CONTENTS

		Code	No.
1.04/1A	15.2	1675982	1.04/ST
1.04/2A			
1.04/3A			

## SPECIFICATIONS

No.	Code	a <sub>1</sub>	a <sub>2 min</sub>	a <sub>2 max</sub>	b	max. t			optional	c	d	e		
1.04/1A	1307703	130	70	170	100	3.0	M 14x1,5 x 140	17	-	22	12	3.0	x	1.2
1.04/2A	1307827	200	110	260	150	5.0	G 1/2 x 210	22	1.06/HSP1	30	18	3.5	x	3.4
1.04/3A	1307940	350	150	420	200	7.5	G 3/4 x 280	27	1.06/HSP2	36	28	6.5	x	7.7

# 1.04/ST-HP-B PULLER SET

with stand

- > Consisting of 3 pullers in different sizes and stand
- > Cross-beam especially hardened and tempered allows safe application of extremely high pulling forces and doubles the tensile force capability
- > Strong drop forged pattern
- > Rigid legs forged from one piece
- > Leg brake - prevents unintentional leg slipping. The leg can be slid along the cross-beam at the push of a button
- > By reversing the legs, this tool can be used as an internal or external puller
- > Scale for uniform adjustment of the puller legs. Allows centred pulling, with optimised application of force, even when extremely high pulling forces are required
- > Upgradeable with hydraulic spindle (see table)



## CONTENTS

		Code	No.
1.04/HP1A-B	15.2	2300044	1.04/ST-HP-B
1.04/HP2A-B			
1.04/HP3A-B			

## SPECIFICATIONS

No.	Code	a <sub>1</sub>	a <sub>2 min</sub>	a <sub>2 max</sub>	b	max. t			optional	c	d	e		
1.04/HP1A-B	1981145	130	70	170	100	5.0	M 14x1,5 x 140	17	-	22	15	3.0	x	1.2
1.04/HP2A-B	1981153	200	110	260	150	10.0	G 1/2 x 210	22	1.06/HSP1	30	24	3.5	x	3.4
1.04/HP3A-B	1981161	350	150	420	200	15.0	G 3/4 x 280	27	1.06/HSP2	36	32	5.0	x	7.7

# 1100-1.04 UNIVERSAL PULLER SET

in L-BOXX® 136

- > Max. capacity up to 5 t
- > 2- and 3-arm cross-beam
- > With rigid and slim legs and extensions
- > Extra-slim pulling legs for cramped spaces are attached for self-mounting
- > The forged leg feet are very slim particularly suitable for barely accessible places
- > 12 different pullers can be combined
- > External Ø up to 130 mm, internal Ø up to 170 mm with a 200 mm clamping reach
- > 1100 CT2-1.04 to retrofit existing L-BOXX®es 136
- > With Check-Tool insert for quick check of completeness
- > As tools are fully sunk in the foam, the equipped insert can be stacked
- > Insert for use in drawers with min. dimensions 400 x 310 x 60 mm



1100-1.04



1100 CT2-1.04

	Code	No.
6.3	2838362	1100-1.04
4.1	2836068	1100 CT2-1.04

Description		Code	No.
Foam insert 2/2 L-BOXX 136, empty	0.200	2836076	EI-1100 CT2-1.04



# 1100-1.04/12A

## PULLER SET INTERNAL/EXTERNAL

in L-BOXX® 136

- > Max. capacity 3 and 5 t
- > For clamping depths up to Ø 200 mm external, Ø 70-260 mm internal, and clamping reach up to 300 mm
- > In 3 of 4 spindles the spindle tip (ball/tip) can be rotated
- > Quick-release pulling legs with integral T-profile for a better transmission of force
- > The forged leg feet are very slim particularly suitable for barely accessible places
- > 2 rigid extensions each 100 and 150 mm with leg brake for quick adjustment of the legs
- > 1100 CT2-1.04/12A to retrofit existing L-BOXX®es 136
- > With Check-Tool insert for quick check of completeness
- > As tools are fully sunk in the foam, the equipped insert can be stacked
- > Insert for use in drawers with min. dimensions 400 x 310 x 90 mm



1100-1.04/12A



1100 CT2-1.04/12A

	Code	No.
9.6	2927241	1100-1.04/12A
7.4	2927268	1100 CT2-1.04/12A

Description	W	D	H		Code	No.
Foam insert 2/2 L-BOXX 136, empty	400	310	90	0.200	2927276	EI-1100 CT2-1.04/12A





# 1.06

## UNIVERSAL PULLER

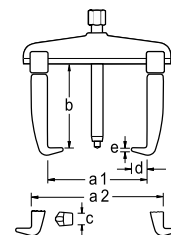
2-arm pattern

- > The tried and tested model for the safe and quick removal of pulleys, wheels, ball bearings, etc.
- > Strong drop forged design
- > Scale for uniform adjustment of the puller legs. Allows centred pulling, with optimised application of force, even when extremely high pulling forces are required
- > By reversing the legs, this tool can be used as an internal or external puller
- > Extra or replacement legs increase versatility
- > Upgradeable with hydraulic spindle (see table)







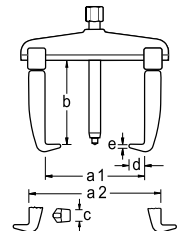

a <sub>1</sub>	a <sub>2 min</sub>	a <sub>2 max</sub>	b	max. t		 mm	optional 	c	d	e			Code	No.
90	60	140	100	3.0	M 14x1,5 x 140	17	-	22	12	3.0	x	1.1	8000230	1.06/1
130	70	180	100	3.0	M 14x1,5 x 140	17	-	22	12	3.0	x	1.3	8000310	1.06/1A
160	80	220	150	5.0	G 1/2 x 210	22	1.06/HSP1	30	18	3.5	x	3.0	8000580	1.06/2
200	90	260	150	5.0	G 1/2 x 210	22	1.06/HSP1	30	18	3.5	x	3.5	8000660	1.06/2A
250	125	330	200	7.5	G 3/4 x 280	27	1.06/HSP2	36	28	6.5	x	7.2	8000740	1.06/3
350	125	420	200	7.5	G 3/4 x 280	27	1.06/HSP2	36	28	6.5	x	8.2	8000820	1.06/3A
520	185	600	200	10.0	G 1 x 310	36	1.06/HSP3	36	28	6.5	-	13.7	8000900	1.06/4

# 1.06 UNIVERSAL PULLER

2-arm pattern, with extended legs

- > Strong drop forged design
- > Scale for uniform adjustment of the puller legs. Allows centred pulling, with optimised application of force, even when extremely high pulling forces are required
- > Extended legs
- > By reversing the legs, this tool can be used as an internal or external puller
- > Extra or replacement legs increase versatility
- > Upgradeable with hydraulic spindle (see table)







$a_1$	$a_{2min}$	$a_{2max}$	b	max. t		 mm	optional 	c	d	e			Code	No.
90	60	140	200	3.0	M 14x1,5 x 140	17	–	22	12	3.0	x	1.5	8108350	1.06/1-2
130	70	180	200	3.0	M 14x1,5 x 140	17	–	22	12	3.0	x	1.6	8108430	1.06/1A-2
160	80	220	300	5.0	G 1/2 x 210	22	1.06/HSP1	30	18	3.5	x	4.1	8108510	1.06/2-3
200	90	260	300	5.0	G 1/2 x 210	22	1.06/HSP1	30	18	3.5	x	4.5	8108780	1.06/2A-3
250	125	330	300	7.5	G 3/4 x 280	27	1.06/HSP2	36	28	6.5	x	9.1	8001200	1.06/3-3
350	125	420	300	7.5	G 3/4 x 280	27	1.06/HSP2	36	28	6.5	x	9.8	8108860	1.06/3A-3
520	185	600	300	10.0	G 1 x 310	36	1.06/HSP3	36	28	6.5	x	15.2	8108940	1.06/4-3
250	125	330	400	7.5	G 3/4 x 280	27	1.06/HSP2	36	28	6.5	x	10.0	8109080	1.06/3-4
350	125	420	400	7.5	G 3/4 x 280	27	1.06/HSP2	36	28	6.5	x	11.1	8109160	1.06/3A-4
520	185	600	400	10.0	G 1 x 310	36	1.06/HSP3	36	28	6.5	-	16.4	8109240	1.06/4-4
250	125	330	500	7.5	G 3/4 x 280	27	1.06/HSP2	36	28	6.5	x	11.3	8109320	1.06/3-5
350	125	420	500	7.5	G 3/4 x 280	27	1.06/HSP2	36	28	6.5	x	12.2	8112380	1.06/3A-5
520	185	600	500	10.0	G 1 x 310	36	1.06/HSP3	36	28	6.5	-	19.0	8112460	1.06/4-5

# 1.06/B UNIVERSAL PULLER

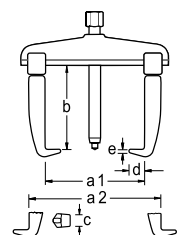
2-arm pattern, rigid legs with leg brake

- > Strong drop forged design
- > Rigid legs forged from one piece
- > Leg brake - prevents unintentional leg slipping. The leg can be slid along the cross-beam at the push of a button
- > Scale for uniform adjustment of the puller legs. Allows centred pulling, with optimised application of force, even when extremely high pulling forces are required
- > By reversing the legs, this tool can be used as an internal or external puller
- > Extra or replacement legs increase versatility
- > Upgradeable with hydraulic spindle (see table)



$a_1$	$a_{2min}$	$a_{2max}$	b	max. t		 mm	optional	c	d	e			Code	No.
100	50	140	100	3.0	M 14x1,5 x 140	17	–	22	15	3.0	x	0.9	1956337	1.06/11-B
140	60	180	100	3.0	M 14x1,5 x 140	17	–	22	15	3.0	x	1.3	1956345	1.06/1A1-B
170	80	220	150	5.0	G 1/2 x 210	22	1.06/HSP1	30	24	3.5	x	2.8	1956353	1.06/21-B
210	90	260	150	5.0	G 1/2 x 210	22	1.06/HSP1	30	24	3.5	x	3.3	1956361	1.06/2A1-B
250	125	340	200	7.5	G 3/4 x 280	27	1.06/HSP2	36	32	5.0	x	6.7	1956388	1.06/31-B
340	125	430	200	7.5	G 3/4 x 280	27	1.06/HSP2	36	32	5.0	x	7.5	1956396	1.06/3A1-B
520	185	610	200	10.0	G 1 x 310	36	1.06/HSP3	36	32	5.0	-	14.0	1958399	1.06/41-B





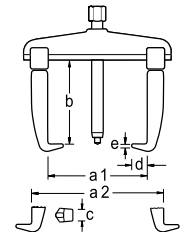

# 1.06/E QUICK-RELEASE PULLER

2-arm pattern

- > The tried and tested model for the safe and quick removal of pulleys, wheels, ball bearings, etc.
- > Strong drop forged pattern
- > Scale for uniform adjustment of the puller legs. Allows centred pulling, with optimised application of force, even when extremely high pulling forces are required
- > By reversing the legs, this tool can be used as an internal or external puller
- > Exchangeable legs for several clamping reaches available as accessories
- > Quick release legs for fast, easy set-up and adjustment
- > Upgradeable with hydraulic spindle (see table)







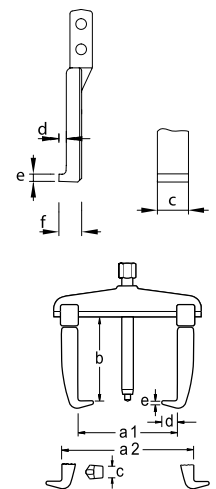

a <sub>1</sub>	a <sub>2 min</sub>	a <sub>2 max</sub>	b	max. t		 mm	optional 	c	d	e		 kg	Code	No.
90	60	140	100	3.0	M 14x1,5 x 140	17	–	22	12	3.0	x	1.1	1213830	1.06/1-E
130	70	180	100	3.0	M 14x1,5 x 140	17	–	22	12	3.0	x	1.3	1215140	1.06/1A-E
160	80	220	150	5.0	G 1/2 x 210	22	1.06/HSP1	30	18	3.5	x	3.0	1216570	1.06/2-E
200	90	260	150	5.0	G 1/2 x 210	22	1.06/HSP1	30	18	3.5	x	3.5	1217720	1.06/2A-E
250	125	330	200	7.5	G 3/4 x 280	27	1.06/HSP2	36	28	6.5	x	7.1	1218980	1.06/3-E
350	125	420	200	7.5	G 3/4 x 280	27	1.06/HSP2	36	28	6.5	x	8.2	1220160	1.06/3A-E

# 1.06/S-E QUICK-RELEASE PULLER

2-arm pattern, with slim legs

- > The forged leg feet are very slim
- > Particularly suitable for barely accessible places
- > Scale for uniform adjustment of the puller legs. Allows centred pulling, with optimised application of force, even when extremely high pulling forces are required
- > Quick release legs for fast, easy set-up and adjustment



a	b	max. t		 mm	optional 	c	d	e	f		 kg	Code	No.
100	100	2.0	M 14x1,5 x 140	17	–	29.8	7.5	3.7	13.5	x	1.0	2015706	1.06/S1-E
140	100	2.5	M 14x1,5 x 140	17	–	29.8	7.5	3.7	13.5	x	1.1	2015714	1.06/S1A-E
160	150	5.0	G 1/2 x 210	22	1.06/HSP1	40.0	7.0	5.0	15.0	x	2.9	2015722	1.06/S2-E
200	150	5.0	G 1/2 x 210	22	1.06/HSP1	40.0	7.0	5.0	15.0	x	3.2	2015730	1.06/S2A-E

5.10

>455



Remember the safety cover!

SPINDLE / LEGS

>452





# 1.06/HSP-B UNIVERSAL PULLER

hydraulic, 2-arm pattern, rigid legs with leg brake

- > Strong drop forged pattern
- > Scale for uniform adjustment of the puller legs. Allows centred pulling, with optimised application of force, even when extremely high pulling forces are required
- > Rigid legs forged from one piece
- > Leg brake - prevents unintentional leg slipping. The leg can be slid along the cross-beam at the push of a button
- > By reversing the legs, this tool can be used as an internal or external puller
- > With the hydraulic spindle, a controlled and safe pulling action is possible at all times
- > The pressure piece can be replaced by a tip and lengthened, as required.
- > The small pressure spindle is secured with an unscrewing lock to stop any accidental withdrawal.
- > Also available with standard spindle - Model 1.06/B

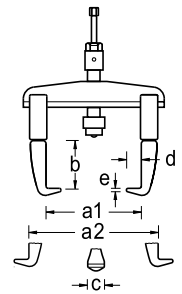

a <sub>1</sub>	a <sub>2</sub>	b	max. t	max. N·m		c	d	e		kg	Code	No.
170	220	70	5.0	9	1.06/HSP1	30	24	3.5	x	3.3	1957899	1.06/21-B-HSP1
210	260	70	5.0	9	1.06/HSP1	30	24	3.5	x	3.4	1957902	1.06/2A1-B-HSP1
250	340	120	7.5	13	1.06/HSP2	36	32	5.0	x	7.2	1957910	1.06/31-B-HSP2
340	430	120	7.5	13	1.06/HSP2	36	32	5.0	x	8.3	1957929	1.06/3A1-B-HSP2
520	610	75	10.0	25	1.06/HSP3	36	32	5.0	-	14.0	1957937	1.06/41-B-HSP3

# 1.06/AS PULLER SET

with 6 legs

- > 2-arm puller, with 6 slim legs in 3 lengths
- > Particularly suitable for barely accessible places

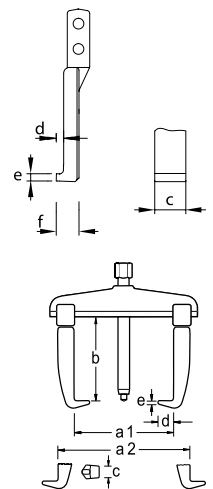

a	b	max. t		mm	optional	c	d	e	f		kg	Code	No.
130	100 / 200 / 250	2.5	M 14x1,5 x 140	17	-	29.5	7.5	3.7	13.5	x	3.4	8001710	1.06/AS
260	150 / 220 / 300	5.0	G 1/2 x 210	22	1.06/HSP1	40.0	7.0	5.0	15.0	x	8.1	1675974	1.06/AS-2

For longer spindles see spindle summary on page 452

# 1.06/ST PULLER SET

with stand

- > Consisting of 5 pullers each in different sizes with standard or quick-release pulling legs
- > Scale for uniform adjustment of the puller legs. Allows centred pulling, with optimised application of force, even when extremely high pulling forces are required
- > For clamping depths up to Ø 250 mm external, Ø 330 mm internal, and clamping reach up to 200 mm



1.06/ST



1.06/ST-E



1.06/ST1-B

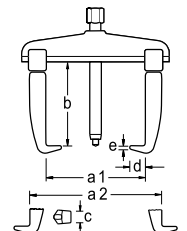

## CONTENTS

		Code	No.
1.06/1 1.06/1A 1.06/2 1.06/2A 1.06/3	19.0	8111570	1.06/ST
1.06/1-E 1.06/1A-E 1.06/2-E 1.06/2A-E 1.06/3-E	19.2	1322745	1.06/ST-E
1.06/11-B 1.06/1A1-B 1.06/21-B 1.06/2A1-B 1.06/31-B	17.2	2004569	1.06/ST1-B

## SPECIFICATIONS





No.	Code	a <sub>1</sub>	a <sub>2 min</sub>	a <sub>2 max</sub>	b	max. t		mm	optional	c	d	e		
1.06/1	8000230	90	60	140	100	3.0	M 14x1,5 x 140	17	–	22	12	3.0	x	1.1
1.06/1A	8000310	130	70	180	100	3.0	M 14x1,5 x 140	17	–	22	12	3.0	x	1.3
1.06/2	8000580	160	80	220	150	5.0	G 1/2 x 210	22	1.06/HSP1	30	18	3.5	x	3.0
1.06/2A	8000660	200	90	260	150	5.0	G 1/2 x 210	22	1.06/HSP1	30	18	3.5	x	3.5
1.06/3	8000740	250	125	330	200	7.5	G 3/4 x 280	27	1.06/HSP2	36	28	6.5	x	7.2
1.06/1-E	1213830	90	60	140	100	3.0	M 14x1,5 x 140	17	–	22	12	3.0	x	1.1
1.06/1A-E	1215140	130	70	180	100	3.0	M 14x1,5 x 140	17	–	22	12	3.0	x	1.3
1.06/2-E	1216570	160	80	220	150	5.0	G 1/2 x 210	22	1.06/HSP1	30	18	3.5	x	3.0
1.06/2A-E	1217720	200	90	260	150	5.0	G 1/2 x 210	22	1.06/HSP1	30	18	3.5	x	3.5
1.06/3-E	1218980	250	125	330	200	7.5	G 3/4 x 280	27	1.06/HSP2	36	28	6.5	x	7.1
1.06/11-B	1956337	100	50	140	100	3.0	M 14x1,5 x 140	17	–	22	15	3.0	x	0.9
1.06/1A1-B	1956345	140	60	180	100	3.0	M 14x1,5 x 140	17	–	22	15	3.0	x	1.3
1.06/21-B	1956353	170	80	220	150	5.0	G 1/2 x 210	22	1.06/HSP1	30	24	3.5	x	2.8
1.06/2A1-B	1956361	210	90	260	150	5.0	G 1/2 x 210	22	1.06/HSP1	30	24	3.5	x	3.3
1.06/31-B	1956388	250	125	340	200	7.5	G 3/4 x 280	27	1.06/HSP2	36	32	5.0	x	6.7

# 1.07 UNIVERSAL PULLER

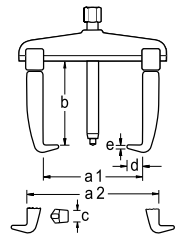
## 3-arm pattern

- > Even load distribution over 3 legs ensures secure grip and balanced pull
- > By reversing the legs, this tool can be used as an internal or external puller
- > Extra or replacement legs increase versatility
- > Upgradeable with hydraulic spindle (see table)







$a_1$	$a_{2\min}$	$a_{2\max}$	b	max. t		 mm	optional 	c	d	e		Code	No.
90	70	140	100	3.0	M 14x1,5 x 140	17	–	22	12	3.0	1.4	8113940	1.07/1
130	80	180	100	3.0	M 14x1,5 x 140	17	–	22	12	3.0	1.6	8114080	1.07/1A
160	100	220	150	5.0	G 1/2 x 210	22	1.06/HSP1	30	18	3.5	3.6	8114160	1.07/2
200	100	260	150	5.0	G 1/2 x 210	22	1.06/HSP1	30	18	3.5	4.2	8114240	1.07/2A
250	100	400	200	7.5	G 3/4 x 280	27	1.06/HSP2	36	28	6.5	9.3	1541757	1.07/3

# 1.07/B UNIVERSAL PULLER

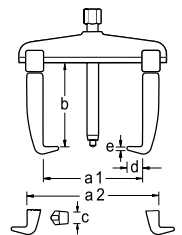
## 3-arm pattern, rigid legs with leg brake

- > Even load distribution over 3 legs ensures secure grip and balanced pull
- > Rigid legs forged from one piece
- > Leg brake - prevents unintentional leg slipping. The leg can be slid along the cross-beam at the push of a button
- > By reversing the legs, this tool can be used as an internal or external puller
- > Extra or replacement legs increase versatility
- > Upgradeable with hydraulic spindle (see table)



$a_1$	$a_{2\min}$	$a_{2\max}$	b	max. t		 mm	optional 	c	d	e		Code	No.
90	70	140	100	3.0	M 14x1,5 x 140	17	–	22	15	3.0	1.2	1957945	1.07/11-B
130	80	180	100	3.0	M 14x1,5 x 140	17	–	22	15	3.0	1.4	1957953	1.07/1A1-B
160	100	220	150	5.0	G 1/2 x 210	22	1.06/HSP1	30	24	3.5	3.5	1957961	1.07/21-B
200	100	260	150	5.0	G 1/2 x 210	22	1.06/HSP1	30	24	3.5	3.7	1957988	1.07/2A1-B
250	100	400	200	7.5	G 3/4 x 280	27	1.06/HSP2	36	28	6.5	8.0	1957996	1.07/31-B





# 1.07/E QUICK-RELEASE PULLER

3-arm pattern

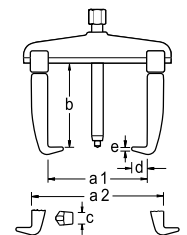
- > Quick release legs for fast, easy set-up and adjustment
- > By reversing the legs, this tool can be used as an internal or external puller
- > Upgradeable with hydraulic spindle (see table)







$a_1$	$a_{2\min}$	$a_{2\max}$	b	max. t		$\bullet$ mm	optional 	c	d	e		Code	No.
<b>90</b>	70	140	100	3.0	M 14x1,5 x 140	17	–	22	12	3.0	1.4	1222902	1.07/1-E
<b>130</b>	80	180	100	3.0	M 14x1,5 x 140	17	–	22	12	3.0	1.6	1225901	1.07/1A-E
<b>160</b>	100	220	150	5.0	G 1/2 x 210	22	1.06/HSP1	30	18	3.5	3.8	1227335	1.07/2-E
<b>200</b>	100	260	150	5.0	G 1/2 x 210	22	1.06/HSP1	30	18	3.5	4.0	1227459	1.07/2A-E
<b>250</b>	100	400	200	7.5	G 3/4 x 280	27	1.06/HSP2	36	28	6.5	9.2	1554751	1.07/3-E

# 1.07/S-E QUICK-RELEASE PULLER

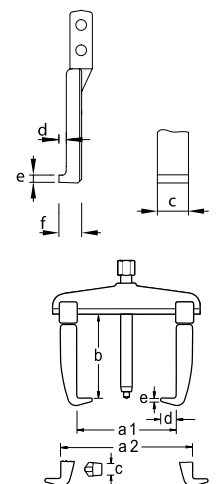
3-arm pattern, with slim legs

- > The forged leg feet are very slim
- > Particularly suitable for barely accessible places
- > Quick release legs for fast, easy set-up and adjustment





a	b	max. t		$\bullet$ mm	optional 	c	d	e	f		Code	No.
<b>90</b>	100	2.5	M 14x1,5 x 140	17	–	29.5	7.5	3.7	13.5	1.3	2016036	1.07/S1-E
<b>130</b>	100	2.5	M 14x1,5 x 140	17	–	29.5	7.5	3.7	13.5	1.4	2016044	1.07/S1A-E
<b>160</b>	150	5.0	G 1/2 x 210	22	1.06/HSP1	40.0	7.0	5.0	15.0	3.6	2016052	1.07/S2-E
<b>200</b>	150	5.0	G 1/2 x 210	22	1.06/HSP1	40.0	7.0	5.0	15.0	3.9	2016060	1.07/S2A-E

# 1.07/HSP-B UNIVERSAL PULLER

hydraulic, 3-arm pattern, rigid legs with leg brake

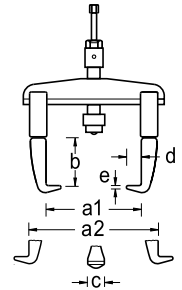
- > Even load distribution over 3 legs ensures secure grip and balanced pull
- > Rigid legs forged from one piece
- > Leg brake - prevents unintentional leg slipping. The leg can be slid along the cross-beam at the push of a button
- > By reversing the legs, this tool can be used as an internal or external puller
- > Extra or replacement legs increase versatility
- > The pressure piece can be replaced by a tip and lengthened, as required.
- > The small pressure spindle is secured with an unscrewing lock to stop any accidental withdrawal.
- > Also available with standard spindle - Model 1.07/B







$a_{1\max}$	$a_{1\min}$	$a_{2\max}$	$a_{2\min}$	b	max. t	max. N·m		c	d	e		Code	No.
160	20	220	140	70	5.0	9	1.06/HSP1	30	24	3.5	4.1	2546566	1.07/21-B-HSP1
200	20	260	140	70	5.0	9	1.06/HSP1	30	24	3.5	4.2	2079984	1.07/2A1-B-HSP1
250	25	340	220	120	7.5	13	1.06/HSP2	36	28	6.5	8.6	2545128	1.07/31-B-HSP2

# 1.07/4 UNIVERSAL PULLER

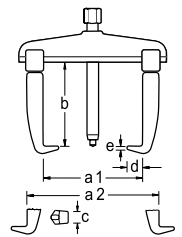
2-/3-arm pattern

- > Just like our standard model no. 1.06, this puller is designed for all branches of industry, but particularly for the construction of electric motors
- > It is also suitable for removing heavy, multistage V-belt pulley wheels, flywheels, gear wheels, etc.
- > Pins are used to lock the arms at 120 degrees to each other on the hub
- > Upgradeable with hydraulic spindle (see table)
- > This puller may also be used with the hydraulic aid no. 1.50 without requiring any reduction bushing
- > On request, this puller is also available with further legs and extendable up to 6 arms



$a_{1\max}$	$a_{1\min}$	$a_{2\max}$	$a_{2\min}$	b	max. t		 mm	optional 	c	d	e		Code	No.
450	150	530	270	200	10	G 1 x 360	36	1.06/HSP3	36	28	6.5	18.8	8002440	1.07/4
580	150	640	270	200	10	G 1 x 360	36	1.06/HSP3	36	28	6.5	22.0	1958003	1.07/4A
450	150	530	270	300	10	G 1 x 360	36	1.06/HSP3	36	28	6.5	21.0	1305085	1.07/4-3
450	150	530	270	500	10	G 1 x 360	36	1.06/HSP3	36	28	6.5	25.2	1305425	1.07/4-5
580	150	640	270	400	10	G 1 x 360	36	1.06/HSP3	36	28	6.5	25.8	2302802	1.07/4A-4
580	150	640	270	500	10	G 1 x 360	36	1.06/HSP3	36	28	6.5	28.4	2302810	1.07/4A-5

1.50

>469







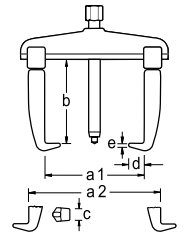

# 1.07/4-B UNIVERSAL PULLER

2-/3-arm pattern, rigid legs with leg brake

- > Just like our standard model no. 1.06, this puller is designed for all branches of industry, but particularly for the construction of electric motors
- > It is also suitable for removing heavy, multistage V-belt pulley wheels, flywheels, gear wheels, etc.
- > Pins are used to lock the arms at 120 degrees to each other on the hub
- > Rigid legs forged from one piece
- > Leg brake - prevents unintentional leg slipping. The leg can be slid along the cross-beam at the push of a button
- > By reversing the legs, this tool can be used as an internal or external puller
- > Upgradeable with hydraulic spindle (see table)
- > This puller may also be used with the hydraulic aid no. 1.50 without requiring any reduction bushing
- > On request, this puller is also available with further legs and extendable up to 6 arms







a <sub>1</sub> max	a <sub>1</sub> min	a <sub>2</sub> max	a <sub>2</sub> min	b	max. t		 mm	optional 	c	d	e		Code	No.
450	150	530	270	200	10		36	1.06/HSP3	36	28	6.5	18.8	2546531	1.07/41-B
580	150	640	270	200	10		36	1.06/HSP3	36	28	6.5	22.0	2546558	1.07/4A1-B

# 1.07/4-HSP-B UNIVERSAL PULLER

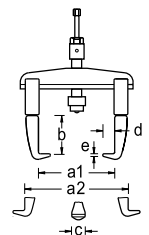
hydraulic, 2-/3-arm pattern, rigid legs with leg brake

- > Just like our standard model no. 1.06, this puller is designed for all branches of industry, but particularly for the construction of electric motors
- > It is also suitable for removing heavy, multistage V-belt pulley wheels, flywheels, gear wheels, etc.
- > Pins are used to lock the arms at 120 degrees to each other on the hub
- > Rigid legs forged from one piece
- > Leg brake - prevents unintentional leg slipping. The leg can be slid along the cross-beam at the push of a button
- > By reversing the legs, this tool can be used as an internal or external puller
- > This puller may also be used with the hydraulic aid no. 1.50 without requiring any reduction bushing
- > On request, this puller is also available with further legs and extendable up to 6 arms
- > The pressure piece can be replaced by a tip and lengthened, as required.
- > The small pressure spindle is secured with an unscrewing lock to stop any accidental withdrawal.
- > Also available with standard spindle - Model 1.07/4-B



a <sub>1</sub> max	a <sub>1</sub> min	a <sub>2</sub> max	a <sub>2</sub> min	b	max. t	max. N·m		c	d	e		Code	No.
450	150	530	270	140	10	25		36	28	6.5	19.9	2546574	1.07/41-B-HSP3
580	150	640	270	140	10	25		36	28	6.5	23.1	2546582	1.07/4A1-B-HSP3





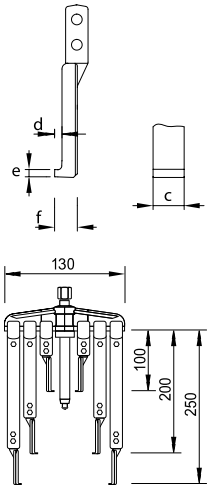

# 1.07/AS PULLER SET

with 9 legs

- > 3-arm puller, with 9 slim legs in 3 lengths
- > Particularly suitable for barely accessible places



a	b	max. t		 mm	optional 	c	d	e	f	 kg	Code	No.
130	100 / 200 / 250	2.5	M 14x1,5 x 140	17	–	29.5	7.5	3.7	13.5	4.8	8117260	1.07/AS
200	150 / 220 / 300	5.0	G 1/2 x 210	22	1.06/HSP1	40.0	7.0	5.0	15.0	11.5	1675990	1.07/AS-2





# 1.07/K PULLER SET

with 9 legs

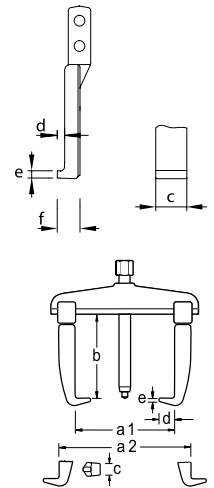
- > In plastic case
- > Contents: 1 spindle, 1 cross-beam each 2- and 3-arm pattern and 9 slim pulling legs in 3 lengths
- > Second spindle in the set 1.07/K saves working time
- > 1.07/K-2 insert with nubs on both sides

1.07/K



a	b	max. t		 mm	optional 	c	d	e	 kg	Code	No.
130	100 / 200 / 250	2.5	M 14x1,5 x 140	17	–	27	7.5	3.7	5.8	8117340	1.07/K
200	150 / 220 / 300	5.0	G 1/2 x 210	22	1.06/HSP1	40	7.0	5.0	13.5	1676008	1.07/K-2





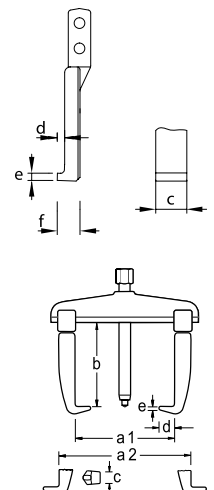

# 1.07/K-SE PULLER SET

with 3 legs

- > In plastic case
- > Contents: 1 spindle, 1 cross-beam each 2- and 3-arm pattern and 3 quick-release pulling legs
- > Second spindle in the set 1.07/K-1-SE saves working time



a <sub>1</sub>	b	max. t		 mm	optional 	c	d	e	 kg	Code	No.
90	100	2.5	M 14x1,5 x 140	17	–	27	7.5	3.7	2.2	1438484	1.07/K-1-SE
160	150	5.0	G 1/2 x 210	22	1.06/HSP1	40	7.0	5.0	5.5	1645455	1.07/K-2-SE

# 1.07/K-SE 5 PULLER SET

with 6 legs

- > In plastic case
- > The forged leg feet are very slim particularly suitable for barely accessible places
- > Quick release legs for fast, easy set-up and adjustment
- > Contents: 2 spindles, 1 cross-beam each 2- and 3-arm pattern, and 6 slim quick-release pulling legs in 2 lengths
- > Clamping reach 100 mm = thickness of hooked foot at tip (e) 3.7 mm, max. 2.5 t
- > Clamping reach 200 mm = thickness of hooked foot at tip (e) 2.0 mm, max. 2.0 t

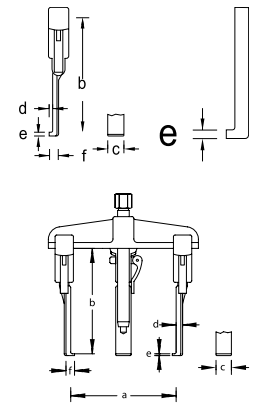





a	b		 mm	c	d		Code	No.
90	100 / 200	M 14x1,5 x 140	17	27	7.5	4.2	1745158	1.07/K-1-SE 200 S

# 1.07/K-HSP PULLER SET

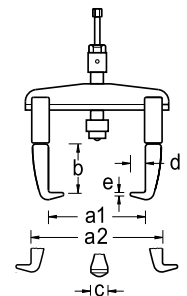
with 3 legs

- > For internal and external use, for hard, everyday use, for industrial use, or on cars and trucks
- > In plastic case
- > Contents: 1 hydraulic spindle, 1 cross-beam each 2- and 3-arm pattern and 3 quick-release pulling legs
- > The pressure piece can be replaced by a tip and lengthened, as required.
- > The small pressure spindle is secured with an unscrewing lock to stop any accidental withdrawal.







a <sub>1</sub>	a <sub>2</sub>	b	max. t	max. N-m		 mm	c	d	e		Code	No.
160	220	70	5.0	9	1.06/HSP1	32	30	18	3.5	7.2	1438492	1.07/K-2-E-HSP1

# 1.07/K-B PULLER SET

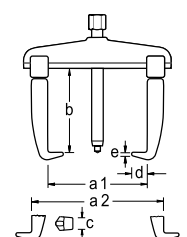
with 3 legs, with leg brake

- > In plastic case
- > Contents: 2 spindles, 1 cross-beam each 2- and 3-arm pattern and 3 rigid legs with leg brake
- > Prevents unintentional leg slipping. The leg can be slid along the cross-beam at the push of a button
- > By reversing the legs, this tool can be used as an internal or external puller
- > Extra spindle supplied for convenience







a	b	max. t		 mm	c	d	e		Code	No.
140	100	3.0	M 14x1,5 x 140	17	22	15	3.0	2.9	2224097	1.07/K-1A-B

# 1.08 UNIVERSAL PULLER

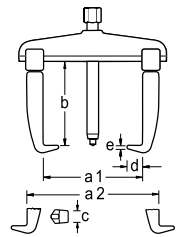
2-arm pattern, with fast spindle adjustment

- > Twice as fast and twice as simple
- > With the fast spindle adjustment feature, the spindle can be set the desired range in a moment. When the clamping yoke is released, the 4-part internal thread closes, and takes the full working pressure



$a_1$	$a_{2\min}$	$a_{2\max}$	b	max. t			c	d	e		Code	No.
200	110	260	150	5.0	G 1/2 x 210	22	30	18	3.5	4.1	8000070	1.08/2A

1500 ES-1.07

>103



1100-1.04

>56



1100-1.30

>57



# SUMMARY OF PULLER LEGS

106/XX-YY-ZZ xx = Leg size (A-C) yy = Leg length (in mm) zz = Leg type

for 2-arm puller  
for 3-arm puller  
Mechanical replacement spindle  
Hydraulic replacement spindle

# A

1.04/1A... 1.04/HP1A...  
1.06/1... 1.06/1A...  
1.07/1... 1.07/1A...  
M14x1,5

## TE = THE PROVEN LEG

### 104/TE

> Quick-release pulling leg for 1.04

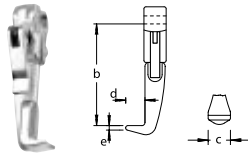

b	c	d	e		Code	No.
100	22	12	3.0	0.3	1499351	104/A-100-TE

## N = THE PROVEN LEG

### 106/N

> 1 leg incl. clamping parts with the reliable screw connection in various lengths

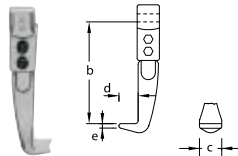

b	c	d	e		Code	No.
100	22	12	3.0	0.260	1120514	106/A-100-N
200	22	12	3.0	0.440	1120522	106/A-200-N

## B = THE STURDY LEG

### 106/B

> 1 leg with leg brake, secured against unintentional slipping, movement of the leg on the cross-beam at the touch of a button, forged from one piece

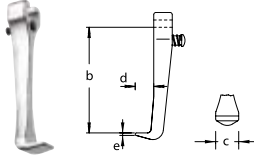

b	c	d	e		Code	No.
100	22	15	3.0	0.240	1970534	106/A-100-B

## E = THE QUICK USE LEG

### 106/E

> leg incl. clamping parts with quick-release adjustment, for fast and uncomplicated setting and adjustment

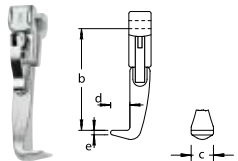

b	c	d	e		Code	No.
100	22	12	3.0	0.280	1178199	106/A-100-E

## SE = THE SLENDER LEG

### 106/SE

> 1 slim leg incl. clamping parts with quick-release adjustment, for fast and uncomplicated setting and adjustment

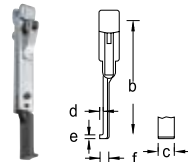

b	c	d	e	f		Code	No.
100	27	7.5	3.7	13.5	0.280	1438514	106/A-100-SE
200	27	7.5	3.7	13.5	0.440	2015757	106/A-200-SE
250	27	7.5	3.7	13.5	0.580	2015773	106/A-250-SE
100	27	7.5	2.0	13.5	0.280	2015781	106/A-100-SSE
200	27	7.5	2.0	13.5	0.460	2015811	106/A-200-SSE
250	27	7.5	2.0	13.5	0.580	2015846	106/A-250-SSE

## XSE = THE SOPHISTICATED LEG 106/XSE

> 1 extra slim leg incl. clamping parts with quick-release adjustment, for fast and uncomplicated setting and adjustment  
> Particularly suitable for barely accessible places, e.g. gear maintenance

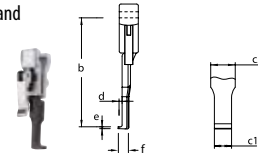

b	c <sub>1</sub>	c <sub>2</sub>	d	e	f		Code	No.
100	16.0	25	5.0	3.7	9.6	0.240	2018748	106/A-100-XSE

## VB = THE FLEXI LEG

### 106/VB

with leg brake

> Using the extension between cross-beam and leg the clamping reach can be extended indefinitely  
> Forged from one piece  
> Leg brake for more safety

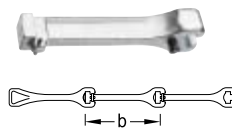

b		Code	No.
100	0.236	2329034	106/A-100-VB

## THE SLIM FIT LEG

### 106/S - 108/XS

> The small black  
> 1 slim leg foot for use in confined spaces

\*S = Spare foot for THE SLIM

\*\*XS = Spare foot for THE FILIGREE

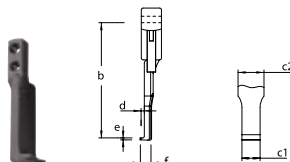

c	d	e	f		Code	No.
27	7.5	3.7	14.5	0.100	1076957	106/S101
27	7.5	2.0	14.5	0.110	1495607	106/S101-S

c <sub>1</sub>	c <sub>2</sub>	d	e	f		Code	No.
16.0	25	5.0	3.7	9.6	0.102	2013681	106/XS101

# B

1.04/2A... 1.04/HP2A...  
1.06/2... 1.06/2A...  
1.07/2... 1.07/2A...  
G1/2"  
1.06/HSP1

# C

1.04/3A... 1.04/HP3A...  
1.06/3... 1.06/3A... 1.06/4...  
1.07/3... 1.07/4... 1.07/4A...  
G3/4"  
1.06/HSP2 1.06/HSP3

b	c	d	e		Code	No.
150	30	18	3.5	0.7	1499378	104/B-150-TE

b	c	d	e		Code	No.
200	36	28	6.5	2.9	1499386	104/C-200-TE

b	c	d	e		Code	No.
150	30	18	3.5	0.700	1120530	106/B-150-N
300	30	18	3.5	1.250	1123947	106/B-300-N

b	c	d	e		Code	No.
200	36	28	6.5	1.560	1120549	106/C-200-N
300	36	28	6.5	2.360	1120557	106/C-300-N
400	36	28	6.5	2.940	1120565	106/C-400-N
500	36	28	6.5	3.500	1120573	106/C-500-N

b	c	d	e		Code	No.
150	30	24	3.5	0.580	1970542	106/B-150-B

b	c	d	e		Code	No.
200	36	32	5.0	1.160	1970550	106/C-200-B

b	c	d	e		Code	No.
150	30	18	3.5	0.720	1178253	106/B-150-E

b	c	d	e		Code	No.
200	36	28	6.5	1.520	1178350	106/C-200-E

b	c	d	e	f		Code	No.
150	40	7.0	5.0	15.0	0.700	1671499	106/B-150-SE
220	40	7.0	5.0	15.0	0.980	2015862	106/B-220-SE
300	40	7.0	5.0	15.0	1.230	2015870	106/B-300-SE

b	c <sub>1</sub>	c <sub>2</sub>	d	e	f		Code	No.
150	17.5	32	5.5	3.5	11.0	0.620	2018756	106/B-150-XSE

b		Code	No.
150	0.560	2329042	106/B-150-VB

b		Code	No.
200	1.320	2329050	106/C-200-VB

c	d	e	f		Code	No.
40	7.0	5.0	15.5	0.330	1671898	108/S201

c <sub>1</sub>	c <sub>2</sub>	d	e	f		Code	No.
17.5	32	5.5	3.5	11.0	0.230	2013711	108/XS201



## Spindle summary

# GEDORE SPINDLES ...

- › ... **require no maintenance!**
- › ... comprise turned hardened and tempered steel. The fine thread is then rolled - this additional strengthening of the steel gives rolled thread a higher strength than a thread produced by cutting.
- › ... have a fine thread which stops any unintended slackening from vibrations.
- › ... are thermo-chemically treated. Nitro-carburating makes the spindle extremely wear-resistant and corrosion-proof. Nitro-carburated surfaces have excellent sliding properties.
- › ... **Oiling and greasing is not needed and**, as such, the thread stays clean and smooth much longer. (Resinated, used oil attracts dirt and chips like magic. The thread pitches clog and turning the thread is not easy - in the final resort, this results in ruination of the thread. Not to speak of that irksome task of regularly filling up with oil.)
- › ... are fitted out with a replaceable spindle tip which is equally suitable for both centred and non-centred shafts\*.

\* As standard with extractors Nos. 1.04 and No.1.09

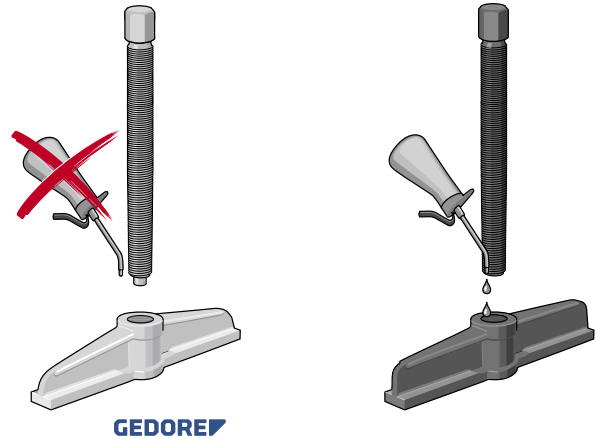

## SPINDLE SUMMARY

- › KS = ball tip, exchangeable
- \* Pull spindle



Threads	usable length	Size/Drive	Ball	Tip	⚖️	Code	No.
M 10x1,5	160	14	x		0.100	1084739	129.106
M 12x1,5	110	14		x	0.100	1084445	1.1206110
M 14x1,5	50	17		x	0.009	1084453	1.1406050
M 14x1,5	125	17	x		0.170	1084461	1.1406125
M 14x1,5	140	17		x	0.180	1084488	1.1406140
M 14x1,5	140	17	x	x	0.180	1546821	<b>1.1406140KS</b>
M 14x1,5	150	17		x	0.009	1084798	144.15006
M 14x1,5	155	17		x	0.009	1084518	1.1406155
M 14x1,5	200	17	x		0.220	1576224	1.1406200
M 14x2,0	210	17	x		0.250	1084755	129.306
M 18x1,5	80	19		x	0.185	1084526	1.1806080
M 18x1,5	130	19		x	0.280	1084542	1.1806130
M 18x1,5	170	19		x	0.345	1084550	1.1806170
M 18x1,5	200	19		x	0.009	1084569	1.1806200
M 18x2,5	230	19	x		0.500	1084763	129.406
G 1/2"	110	22	x		0.340	1084577	1.2106110
G 1/2"	160	22		x	0.455	1084585	1.2106160

Threads	usable length	Size/Drive	Ball	Tip	⚖️	Code	No.
G 1/2"	175	22		x	0.009	1084623	1.2106175
G 1/2"	210	22		x	0.590	1084593	1.2106210
G 1/2"	210	22	x	x	0.180	1546872	1.2106210KS
G 1/2"	250	22		x	0.680	1084631	1.2106250
G 1/2"	250	22	x	x	0.680	1795112	1.2106250KS
G 1/2"	350	22			0.009	1084658	1.2106350
G 1/2"	350	22	x	x	0.010	1806564	1.2106350KS
G 1/2"	400	16			1.100	*1076132	1/2106400
M 20x2,5	235	22	x		0.500	1084771	129.506
G 3/4"	200	27		x	0.980	1084666	1.2606180
G 3/4"	280	27		x	1.200	1084674	1.2606280
G 3/4"	280	27	x	x	1.300	1546910	1.2606280KS
G 1"	310	36		x	2.238	1084690	1.3306310
G 1"	360	36		x	2.540	1084704	1.3306360
G 1"	500	36		x	3.600	1084712	1.3306500
G 1.1/4"	270	41		x	3.160	1084720	1.4206270

## Spindles - Mechanical spindle, hydraulic spindle or hydraulic press?



- › The GEDORE puller mechanical spindles provide plenty of benefits: made of hardened and tempered steel, rolled fine thread and thermo-chemically treated - hence they are especially both wear and corrosion resistant.
- › Particularly with high forces, using a hydraulic spindle can be both time and effort-saving. The hydraulic spindle principle is both straightforward and ingenious at the same time. The effect of screwing in the clamping bolt is to compress the grease inside the hydraulic piston - the extending piston acts on the part to be extracted with a force many times greater than that

- manually applied at the top. This controlled operation provides for working safely with the hydraulic spindle and is recommended, in particular, for high levels of force.
- › The hydraulic press represents an alternative to the hydraulic spindle. It is attached between the mechanical spindle and shaft and through hydraulic force supports the spindle.
- › As the puller cannot be rotated during extraction, pulling with the assistance of hydraulic aids saves both on time and the effort needed.



# 1.06/HSP HYDRAULIC PRESSURE SPINDLE

- > For controlled and safe pulling work
- > Set up for a pressure of 10 t, 12 t or 15 t
- > The pressure piece can be replaced by a tip and lengthened, as required.
- > The small pressure spindle is secured with an unscrewing lock to stop any accidental withdrawal.

**Preparation for use:**

1. Before using, check whether the pressure spindle is screwed far enough out of the cap, so that the pressure pad is in the initial position in the hydraulic cylinder.
2. Unscrew the cap from the spindle body. For this purpose, first slacken off the grub screw.
3. Screw the spindle body from beneath into the cross piece of the puller until the body protrudes approx. 60 mm from the cross piece.
4. Screw the cap onto the spindle body until the stop, and then fix it in position by turning in the grub screw.

**Use and operation: e.g. HSP3**

5. Place the puller into position and pre-tension the spindle body using a size 41 mm wrench.
6. Screw the pressure spindle size 17 mm into the cap. The hydraulic effect will come into use. The stroke of the pressure pad in the hydraulic cylinder is max. 12 mm. The workpiece that has been loosened by the hydraulic force may be pulled off completely by turning the spindle body with the cap size 41 mm.
7. Following its use, the pressure spindle (size 17 mm) is turned back into its initial position and the pressure pad pushed into the hydraulic cylinder.



optional

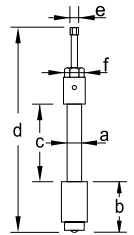

a	max. t	max. N-m	b	c	d	e	f	Stroke		Code	No.
<b>G 1/2"</b>	10	17	80	135	350	12	32	12	1.1	8116100	1.06/HSP1
<b>G 3/4"</b>	12	19	80	205	420	12	36	12	1.8	8116290	1.06/HSP2
<b>G 1"</b>	15	33	125	165	465	17	41	12	3.3	8116370	1.06/HSP3

# 1.06/HSP-V EXTENSION FOR HYDRAULIC SPINDLE



1.06/HSP-35V / -85V / -135V

usable length	↳mm↲		Code	No.
<b>35</b>	60	0.250	2824787	1.06/HSP-35V
<b>85</b>	110	0.600	2824841	1.06/HSP-85V
<b>135</b>	160	0.950	2824868	1.06/HSP-135V

# 1.06/HSP-D THRUST-CARRYING MEMBER FOR HYDRAULIC SPINDLE



DSK / DK / DS

Execution		Code	No.
<b>with ball</b>	0.170	2824876	1.06/HSP12-DK
<b>with tip</b>	0.130	2824884	1.06/HSP12-DS
<b>with tip, short</b>	0.070	2824892	1.06/HSP12-DSK
<b>with tip</b>	0.200	2824906	1.06/HSP3-DS

# 1.55 HYDRAULIC PRESS

- > This piece of auxiliary equipment considerably increases the capability of the standard pressure spindle
- > Operation: With pressure released, the press is placed between the pressure spindle and the end of the shaft. The pressure spindle is then tightened firmly. Care must be taken that the centreline of the shaft, the hydraulic press, and the pressure spindle are exactly in alignment. Then the hydraulic spindle is screwed inwards.
- > **Important note:** Release the hydraulic press after use



max. t	Stroke height	Installation height		Code	No.
<b>8</b>	10	75	1.0	8024090	1.55/1
<b>15</b>	15	90	1.8	8024170	1.55/2





## Spindle pressure pads

# 1.80 SPINDLE PRESSURE PADS

for axle bores (hollow shafts)

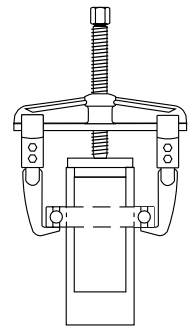
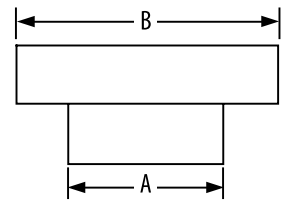
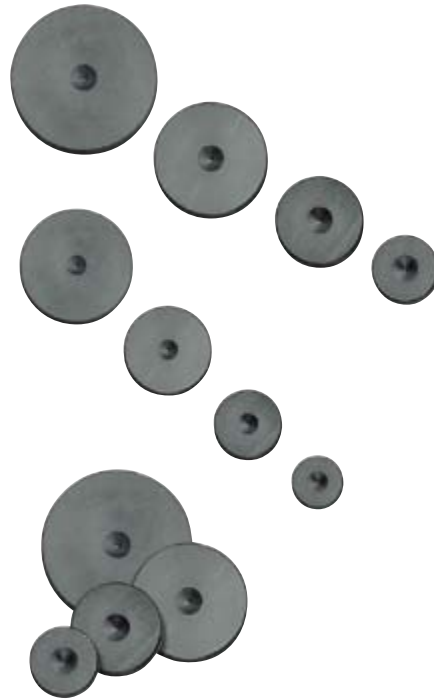
- › For the removal of bearings and gear wheels that are mounted on hollow shafts or in housings
- › The spindle pressure pad serves as a counter-axis to the puller, where the spindle now transfers the force to the pressure pad



A Holder Ø	B Plate Ø	 kg	Code	No.
19	25	2.3	1120697	1.80/1
22	28			
25	32			
28	35			
32	41			
35	44			
38	48			
41	50			
44	54			
48	60			
50	64			
54	67	2.4	1120700	1.80/2
57	70			
60	73			
64	78			
70	83			
76	90			
32	41	4.3	1120719	1.80/3
35	44			
38	48			
41	50			
44	54			
48	60			
50	64			
54	67			
57	70			
60	73			
64	78			
70	83			
76	90			

## Bearing assembly

### 1.85/1 PROFESSIONAL PLASTIC BEARING INSTALLATION SET

- > The impact-resistant plastic is handily light, but just as robust as the metal variants
- > The impact rings are now secured on the pipe
- > Using this bearing installation set more than 200 types of bearings may be re-installed effortlessly and without damage
- > In a strong plastic case, dimensions 450 x 360 x 140 mm



Contents		Code	No.
<b>33 impact rings, 10-50 mm for external Ø 26-110 mm</b>	5.2	1120778	1.85/1
<b>3 aluminium impact sleeves</b>			
<b>1 recoil-free bodywork hammer with nylon heads (1.2 kg)</b>			

## Safety cover

### 5.10 SAFETY COVER SIZE 1



- > At pulling forces of 18 t, these PVC safety covers provide maximum active-safety protection from suddenly detaching ball bearings, driving pinions or small parts. The safety covers are extremely flexible, making them suitable for all situations.
- > Dimensions 510 x 915 mm
- > Double-ply welded = double safety (total thickness at 0.5 mm = 1.0 mm)
- > Tear strength: longitudinal 23 N/mm<sup>2</sup> - lateral 21 N/mm<sup>2</sup>
- > Two straps for variable adjustment
- > Press stud fasteners for added safety - no flapping ends
- > UV resistant
- > Temperature resistant at -25 °C to +50 °C
- > Storage in the supplied carry bag guarantees long service life

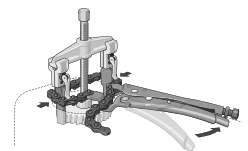

### 136 K CHAIN GRIP WRENCH

- > Particularly suited for clamping geometrically problematical cross-sections
- > With No. 136 K-105 the legs of various pullers - following locking - can be spanned with the chain at the component to be extracted and tightened. This stops the legs bending outwards and slipping. Pulling is still possible even if the legs have a very restricted contact surface.
- > As the chain is 1050 mm long up to a 330 mm circumference is possible



	Code	No.	max. Ø	↳ mm ↳		Code	No.
1.5	1868195	5.10	330	1050	1.5	2307227	136 K-105



## 3-arm External Puller Twist + Pull

### 1.09 PULLER TWIST & PULL

Easy, quick and safe

#### Advantages:

- > No setting-up or readjusting of the legs
- > Maintenance-free due to encapsulated mechanics

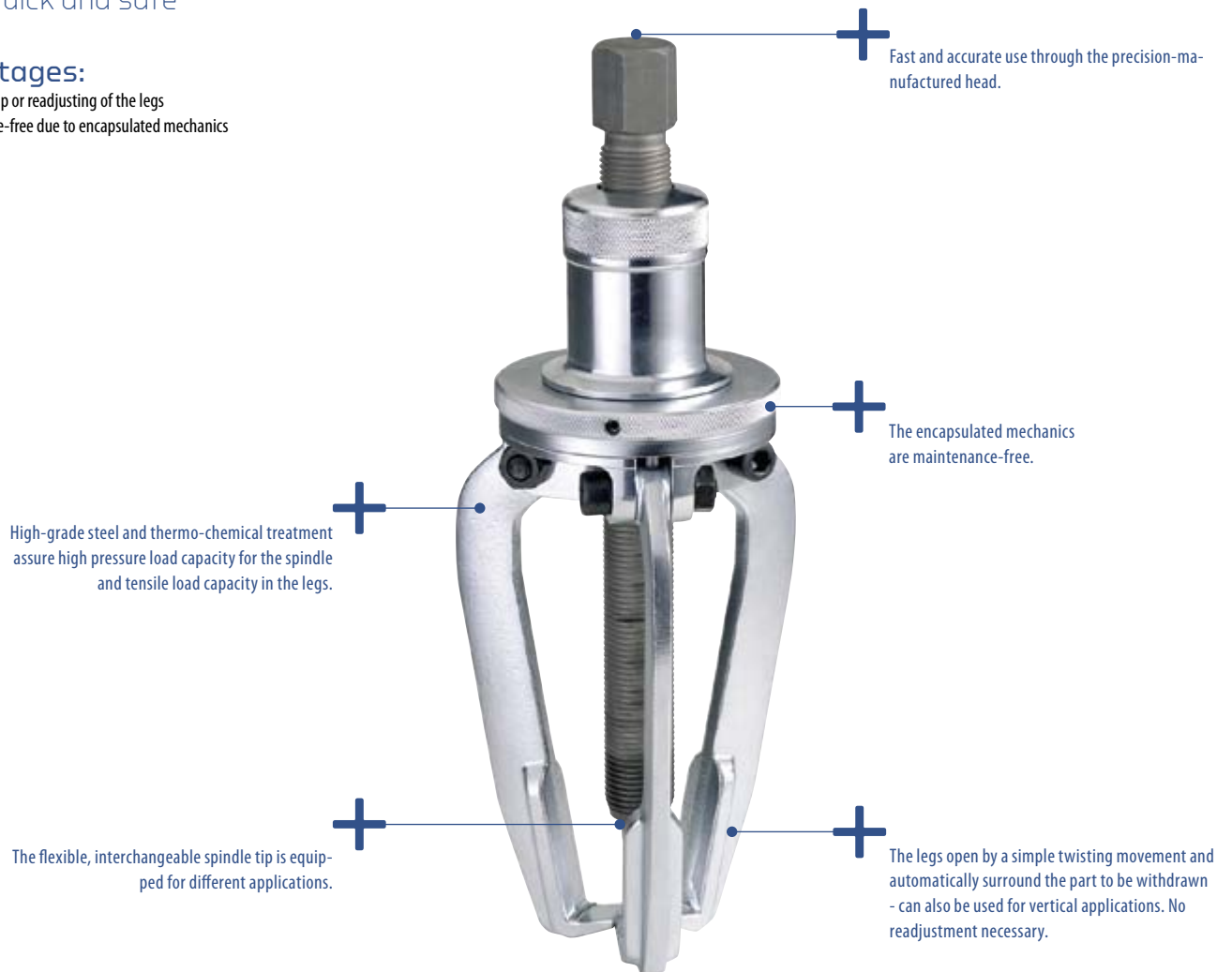



### 1.09 PULLER TWIST + PULL

3-arm pattern, with rotating adjustment

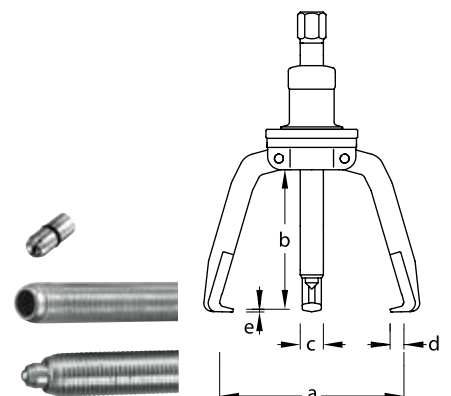
- > The precise manufactured head allows fast and exact use
- > The legs open by simple rotation and enclose automatically the part to be removed
- > No more time-consuming set-up and readjusting of the legs
- > High-quality steel and thermo-chemical treatment guarantee highest toughness of the spindle and the legs
- > Ball or tip can easily be exchanged



a <sub>min</sub>	a <sub>max</sub>	b		 mm	c	d	e	max. t		Code	No.
30	150	130	G 1/2 x 250	22	17	12	3.0	6.5	2.5	1748173	1.09/1
80	250	250	G 1/2 x 350	22	24	12	3.0	6.5	4.2	1748181	1.09/2





# 1.12 BATTERY-TERMINAL PULLER

2-arm pattern

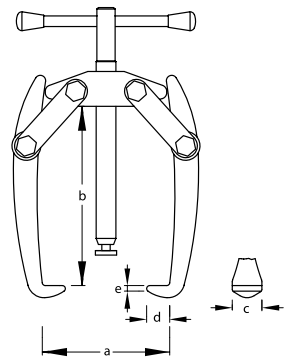
- > Ideal for removing small parts such as battery terminals, pulleys, wheels, ball bearings, etc.
- > The legs grip automatically





a <sub>max</sub>	b	max. t		c	d	e		Code	No.
60	40	0.5	M 10x1,5 x 60	10	5	2	0.160	8003840	1.12/02
60	60	0.5	M 10x1,5 x 80	10	5	2	0.180	8003760	1.12/01
70	80	0.5	M 10x1,5 x 100	14	8	2	0.300	1628402	1.12/00

# 1.13 BATTERY-TERMINAL PULLER

3-arm pattern

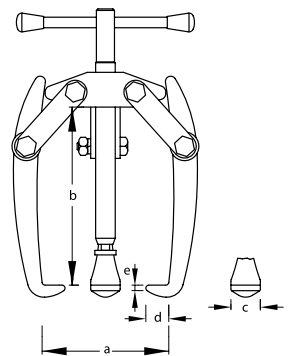
- > Ideal for removing small parts such as battery terminals, pulleys, wheels, ball bearings, etc.
- > The legs grip automatically





a <sub>max</sub>	b	max. t		c	d	e		Code	No.
60	40	0.75	M 10x1,5 x 60	10	5	2	0.200	8004650	1.13/02
60	60	0.75	M 10x1,5 x 80	10	5	2	0.200	8004570	1.13/01
70	80	1.0	M 10x1,5 x 100	14	8	2	0.400	1628410	1.13/00

# 112 PULLING LEG

- > Complete with clips and screws



	b	c	d	e		Code	No.
1.12/02 + 1.13/02	40	10	5	2	0.050	2303132	112/02-040
1.12/01 + 1.13/01	60	10	5	2	0.050	2303140	112/01-060
1.12/00 + 1.13/00	80	14	8	2	0.100	2303159	112/00-080





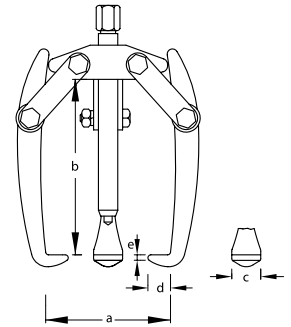

## 1.12 PULLER

### 2-arm pattern

- > Handy robust model for the removal of pulleys, wheels, ball bearings, etc.
- > Inexpensive economy model
- > The legs grip automatically







a <sub>max</sub>	b	max. t		 mm	optional 	c	d	e		Code	No.
70	80	1.0	M 12x1,5 x 110	14	–	14	8	2	0.4	8003250	1.12/0
90	120	2.0	M 14x1,5 x 155	17	–	18	11	2	0.8	8003330	1.12/1
130	160	5.0	M 18x1,5 x 200	19	–	25	14	3	1.9	8003410	1.12/2
180	200	8.0	G 1/2 x 250	22	1.06/HSP1	32	20	4	3.7	8003680	1.12/3

## 1.13 PULLER

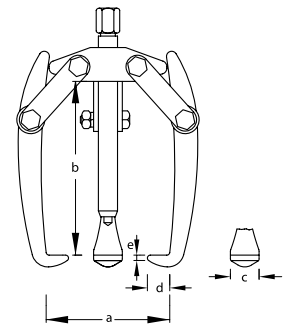
### 3-arm pattern

- > Handy robust model for the removal of pulleys, wheels, ball bearings, etc.
- > Inexpensive economy model
- > The legs grip automatically





a <sub>max</sub>	b	max. t		 mm	optional 	c	d	e		Code	No.
70	80	2.0	M 12x1,5 x 110	14	–	14	8	2	0.5	8004140	1.13/0
90	120	3.0	M 14x1,5 x 155	17	–	18	11	2	1.5	8004220	1.13/1
130	160	7.5	M 18x1,5 x 200	19	–	25	14	3	2.5	8004300	1.13/2
180	200	12.0	G 1/2 x 250	22	1.06/HSP1	32	20	4	5.3	8004490	1.13/3

## 112 PULLING LEG

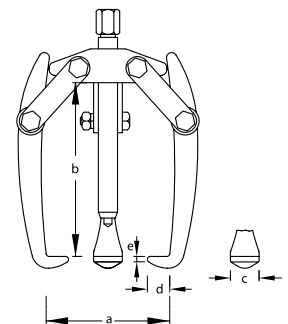
- > Complete with clips and screws



	b	c	d	e		Code	No.
1.12/0 + 1.13/0	80	14	8	2	0.095	2303167	112/0-080
1.12/1 + 1.13/1	120	18	11	2	0.205	2303175	112/1-120
1.12/2 + 1.13/2	160	25	14	3	0.550	2303183	112/2-160
1.12/3 + 1.13/3	200	32	20	4	1.070	2303191	112/3-200





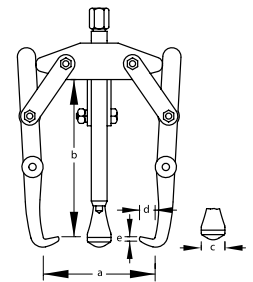

# 1.14 PULLER

## 2-arm pattern

- > The reliable, extra-strong model for the removal of pulleys, wheels, ball bearings, etc.
- > With technical and economical benefits due to the variable clamping reach and automatic grip of the legs
- > Especially suited to removing V-belt pulley wheels and flywheels mounted on longer shafts
- > Upgradeable with hydraulic spindle (see table)







a <sub>max</sub>	b	max. t		 mm	optional 	c	d	e		Code	No.
90	100	1.0	M 12x1,5 x 110	14	–	14	9	2.0	0.4	8004810	1.14/0
130	140	2.0	M 14x1,5 x 140	17	–	18	11	2.0	0.9	8005030	1.14/1
200	210	5.0	M 18x1,5 x 200	19	–	25	16	3.0	2.2	8005380	1.14/2
250	260	8.0	G 1/2 x 250	22	1.06/HSP1	32	18	3.5	4.4	8005460	1.14/3
280	390	8.0	G 1/2 x 250	22	1.06/HSP1	32	20	3.5	5.1	8005540	1.14/4
420	480	8.0	G 1/2 x 350	22	1.06/HSP1	32	20	3.5	6.0	8005620	1.14/5

# 1.15 PULLER

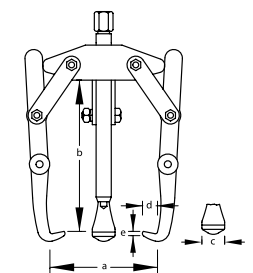
## 3-arm pattern

- > The reliable, extra-strong model for the removal of pulleys, wheels, ball bearings, etc.
- > With technical and economical benefits due to the variable clamping reach and automatic grip of the legs
- > Especially suited to removing V-belt pulley wheels and flywheels mounted on longer shafts
- > Upgradeable with hydraulic spindle (see table)







a <sub>max</sub>	b	max. t		 mm	optional 	c	d	e		Code	No.
90	100	2.0	M 12x1,5 x 110	14	–	14	9	2.0	0.5	8006000	1.15/0
130	140	3.0	M 14x1,5 x 140	17	–	18	11	2.0	1.2	8006190	1.15/1
200	210	7.5	M 18x1,5 x 200	19	–	25	16	3.0	3.3	8006350	1.15/2
250	260	12.0	G 1/2 x 250	22	1.06/HSP1	32	18	3.5	6.3	8006430	1.15/3
280	390	12.0	G 1/2 x 250	22	1.06/HSP1	32	20	3.5	7.7	8006510	1.15/4
420	480	12.0	G 1/2 x 350	22	1.06/HSP1	32	20	3.5	8.9	8006780	1.15/5

# 1.15/HSP PULLER

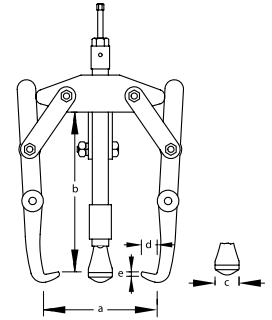
hydraulic, 3-arm pattern

- > The reliable, extra-strong model for the removal of pulleys, wheels, ball bearings, etc.
- > With technical and economical benefits due to the variable clamping reach and automatic grip of the legs
- > Especially suited to removing V-belt pulley wheels and flywheels mounted on longer shafts
- > With the hydraulic spindle, a controlled and safe pulling action is possible at all times
- > Also available with standard spindle - Model 1.15





a <sub>max</sub>	b	max. t	max. N-m			c	d	e		Code	No.
250	180	10	17	1.06/HSP1	32	32	18	3.5	6.6	1392956	1.15/3-HSP1
280	310	10	17	1.06/HSP1	32	32	20	3.5	8.1	1392980	1.15/4-HSP1

# 114 PULLING LEG

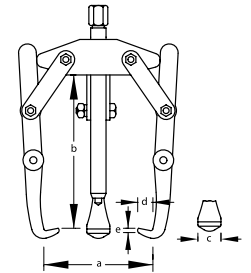
- > With variable clamping reach
- > Complete with clips and screws







	b	c	d	e		Code	No.
1.14/0 + 1.15/0	100	14	9	2.0	0.100	2303213	114/0-100
1.14/1 + 1.15/1	140	18	11	2.0	0.250	2303221	114/1-140
1.14/2 + 1.15/2	210	25	16	3.0	0.750	2303248	114/2-210
1.14/3 + 1.15/3	260	32	18	3.5	1.470	2303256	114/3-260
1.15/3-HSP1							
1.14/4 + 1.15/4	390	32	20	3.5	1.750	2303264	114/4-390
1.15/4-HSP1							
1.14/5 + 1.15/5	480	32	20	3.5	2.150	2303272	114/5-480

# 1.14/L FAN PULLER

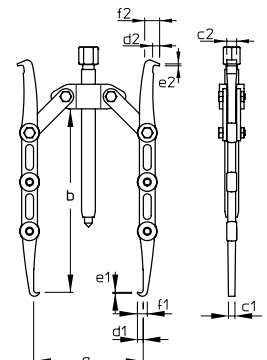
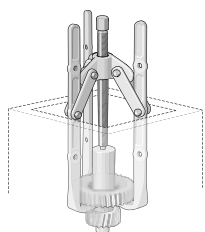
2-arm pattern

- > Especially slender legs will each adjust to 3 clamping positions
- > The double leg ends, wide or narrow, clamp automatically when under tension
- > For use on fans with 2-holes up from Ø 10 mm



a <sub>max</sub>	b	max. t			c <sub>1</sub>	c <sub>2</sub>	d	e <sub>1</sub>	e <sub>2</sub>	f <sub>1</sub>	f <sub>2</sub>		Code	No.
150	100-200	1.0	M 14x1,5 x 155	17	6.6	10	6	1	2	10	16.5	0.9	8005110	1.14/1L



# 1.15/L FAN PULLER

## 3-arm pattern

- > Especially slender legs will each adjust to 3 clamping positions
- > The double leg ends, wide or narrow, clamp automatically when under tension
- > For use on fans with 3-holes up from Ø 10 mm

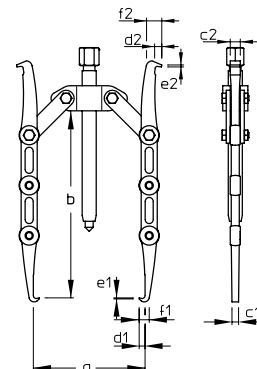
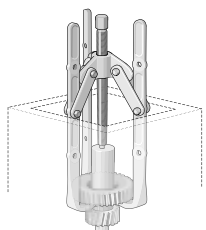

$a_{max}$	b	max. t			$c_1$	$c_2$	d	$e_1$	$e_2$	$f_1$	$f_2$		Code	No.
150	100-200	1.5	M 14x1,5 x 155	17	6.6	10	6	1	2	10	16.5	1.3	8006270	1.15/1L

# 114/L PULLING LEG

- > Especially slender leg will adjust to 3 clamping positions
- > Complete with 2 clips and 2 screws

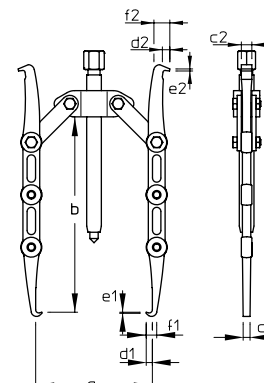

	b	$c_1$	$c_2$	d	$e_1$	$e_2$	$f_1$	$f_2$		Code	No.
1.14/1L + 1.15/1L	100 / 150 / 200	6.6	10	6	1	2	10	16.5	0.3	2303310	114/1-200-L

# 1.16 PULLER

## 2-arm pattern

- > Very strong
- > Made for industrial applications and for use on heavy agricultural and construction machines
- > The legs grip automatically
- > Upgradeable with hydraulic spindle (see table)
- > Can be extended to 3 arms by additionally buying a large hook no. 116

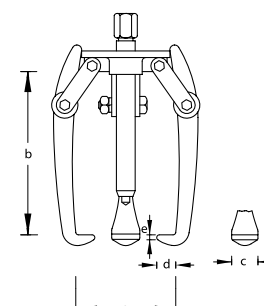





$a_{max}$	b	max. t			optional	c	d	e		Code	No.
300	300	8.0	G 1 x 360	36	1.06/HSP3	32	19	3.0	8.4	8007080	1.16/1
450	420	8.0	G 1 x 500	36	1.06/HSP3	32	22	3.0	10.0	8007160	1.16/2

# 1.17 PULLER

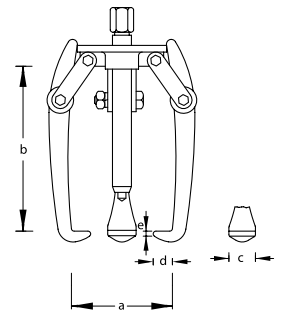
## 3-arm pattern

- > Very strong
- > Made for industrial applications and for use on heavy agricultural and construction machines
- > The legs grip automatically
- > Upgradeable with hydraulic spindle (see table)
- > For the assembly of a 2- or 3-arm puller







a <sub>max</sub>	b	max. t		 mm	optional 	c	d	e		Code	No.
300	300	12.0	G 1 x 360	36	1.06/HSP3	32	19	3.0	10.5	8007320	1.17/1
450	420	12.0	G 1 x 500	36	1.06/HSP3	32	22	3.0	12.7	8007400	1.17/2

# 1.17/HSP PULLER

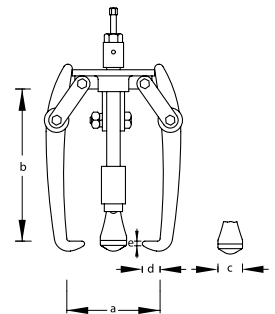
## hydraulic, 3-arm pattern

- > Very strong
- > Made for industrial applications and for use on heavy agricultural and construction machines
- > The legs grip automatically
- > With the hydraulic spindle, a controlled and safe pulling action is possible at all times
- > Also available with standard spindle - Model 1.17





a <sub>max</sub>	b	max. t	max. N-m		 mm	c	d	e		Code	No.
300	190	12.0	29	1.06/HSP3	41	32	19	3.0	11.4	8014290	1.17/1-HSP3
450	295	12.0	29	1.06/HSP3	41	32	22	3.0	12.6	8014370	1.17/2-HSP3

# 116 PULLING LEG

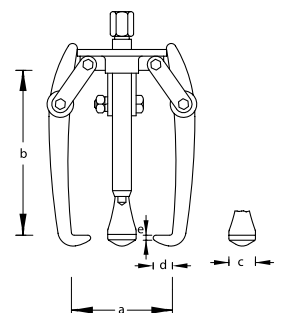
- > Very strong
- > Complete with clips and screws



	b	c	d	e		Code	No.
1.16/1 + 1.17/1 1.16/1-HSP3 + 1.17/1-HSP3	300	32	19	3	1.8	2303280	116/1-300
1.16/2 + 1.17/2 1.16/2-HSP3 + 1.17/2-HSP3	420	32	22	3	2.2	2303299	116/2-420







## 2-/3-arm External Pullers

### 1.18 PULLER

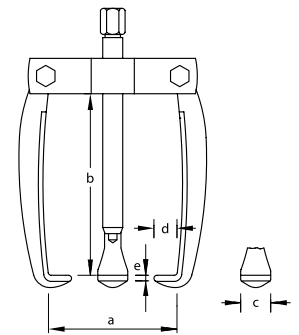
2-arm pattern

> The tried and tested range for economical bearing removal







$a_{max}$	b	max. t		 mm	optional 	c	d	e		Code	No.
<b>110</b>	110	2.0	M 14x1,5 x 163	17	–	17	18	5.0	1.0	1464965	1.18/1
<b>160</b>	140	3.0	M 18x1,5 x 215	19	–	21	20	6.5	2.1	1464973	1.18/2
<b>200</b>	200	5.0	G 1/2 x 282	22	1.06/HSP1	22	22	7.5	3.4	1464981	1.18/3

### 1.19 PULLER

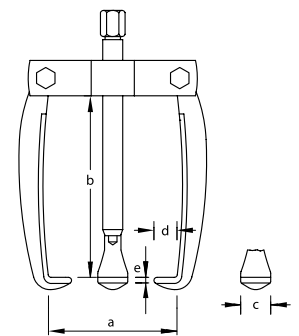
3-arm pattern

> The tried and tested range for economical bearing removal



$a_{max}$	b	max. t		 mm	optional 	c	d	e		Code	No.
<b>110</b>	110	2.0	M 14x1,5 x 163	17	–	17	18	5.0	1.4	1465007	1.19/1
<b>160</b>	140	3.0	M 18x1,5 x 215	19	–	21	20	6.5	2.7	1465015	1.19/2
<b>200</b>	200	5.0	G 1/2 x 282	22	1.06/HSP1	22	22	7.5	4.5	1465023	1.19/3

1.35/1A

>483



## 1.19/SH PULLER WITH SLIDING HAMMER

- > The tried and tested range for economical bearing removal, spindle not supplied
- > Impact weight: 700 g

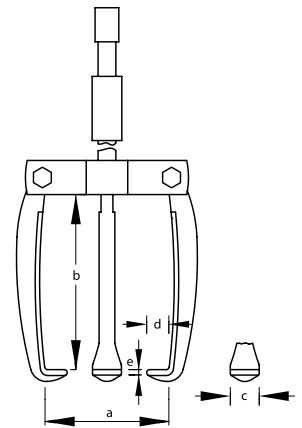

a <sub>max</sub>	b	max. t	c	d	e		Code	No.
70	70	1.0	12	10	3.0	1.2	2178001	1.19/01-SH1A

## 1.18 FAN PULLER

2-arm pattern

- > Removes bearings swiftly and cleanly
- > Can also be used with sliding hammer no. 1.35/1A

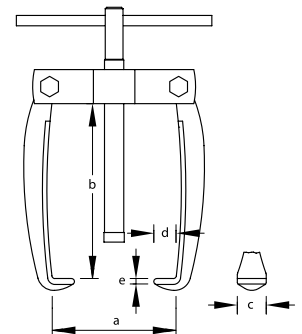

a <sub>max</sub>	b	max. t		c	d	e		Code	No.
65	50	1.0	M 10 x 115	12	10	3.0	0.230	1656996	1.18/02
70	70	1.0	M 10 x 115	12	10	3.0	0.240	1657089	1.18/01
80	80	1.0	M 10 x 115	12	10	3.0	0.240	1656937	1.18/0

## 1.19 FAN PULLER

3-arm pattern

- > Removes bearings swiftly and cleanly
- > Can also be used with sliding hammer no. 1.35/1A

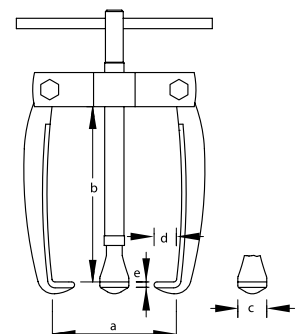

a <sub>max</sub>	b	max. t		c	d	e		Code	No.
65	50	1.0	M 10 x 115	12	10	3.0	0.280	1657054	1.19/02
70	70	1.0	M 10 x 115	12	10	3.0	0.300	1657046	1.19/01
80	80	1.0	M 10 x 115	12	10	3.0	0.300	1657011	1.19/0







# 1.18/XS PULLER

with extra slim legs

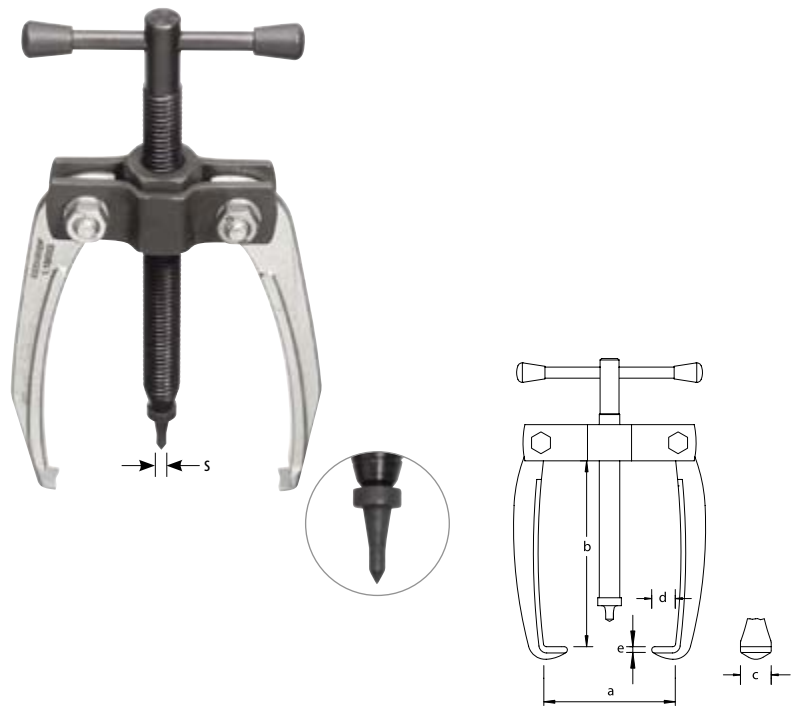
- > Very slim forged legs
- > Ideal for use in hard-to-reach places, e.g. work on electric motors





a <sub>max</sub>	b	max. t		c	d	e	s		Code	No.
50	70	0.5	M 10x1,5 x 100	8	3	2	2,9	0.240	2018594	1.18/0XS

# 1.19/XS PULLER

with extra slim legs

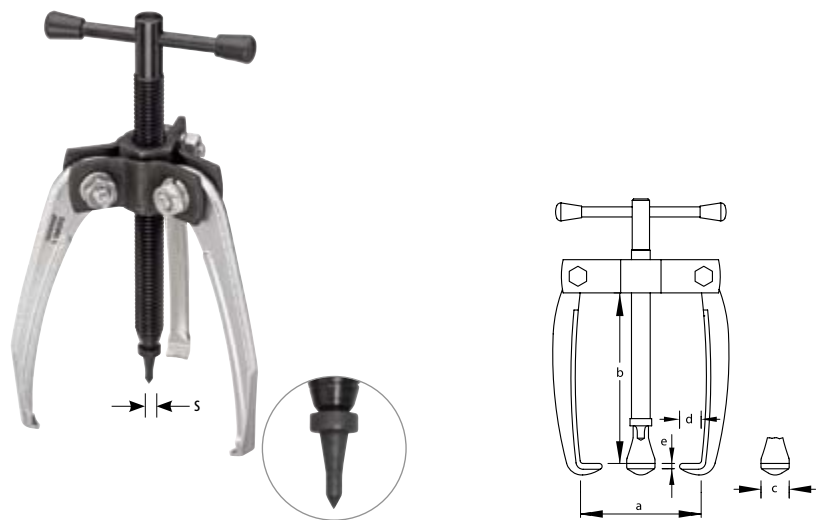
- > Very slim forged legs
- > Ideal for use in hard-to-reach places, e.g. work on electric motors



a <sub>max</sub>	b	max. t		c	d	e	s		Code	No.
50	70	0.8	M 10x1,5 x 100	8	3	2	2,9	0.300	2018608	1.19/0XS

# CLAMPING YOKE

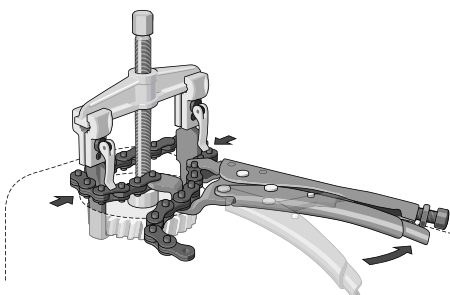

- > The clamping yokes stop the legs bending outwards under load and thus possibly slipping.
- > This can also be attained using the new GEDORE 136 K clamping chain - even with a very restricted contact surface of the legs extracting can still be done.



## Pullers with clamping yoke

### 1.23 PULLER

with slim legs

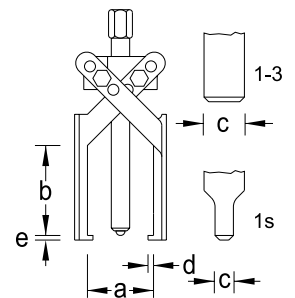
- > For removing bearings in confined spaces
- > The legs grip automatically
- > No. 1.23/S: particularly slim legs



a <sub>max</sub>	b	max. t			c	d	e		Code	No.
80	85	1.5	M 10 x 105	12	11	4	2.5	0.4	8084580	1.23/1S
80	85	2.0	M 10 x 105	12	23	4	2.5	0.4	8084310	1.23/1
120	120	3.5	M 14x1,5 x 130	17	31	5	3.5	0.8	8084660	1.23/2
120	150	3.5	M 14x1,5 x 205	17	31	5	3.5	1.1	8084740	1.23/3

### 1.23/XS PULLER

with extra slim legs

- > Very slim forged legs
- > Ideal for use in hard-to-reach places, e.g. work on electric motors
- > The legs grip automatically

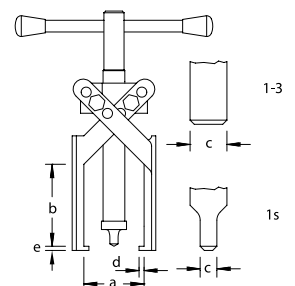

a <sub>max</sub>	b	max. t		c	d	e	s		Code	No.
80	85	0.7	M 10x1,5 x 100	9	3.5	2	2,9	0.330	2018578	1.23/1XS



# 1.20 PULLER

with clamping yoke

- > These pullers are mainly employed for removing car and truck steering arms
- > The clamping yoke applies firm pressure behind the part to be moved and keeps the puller firmly in the correct position

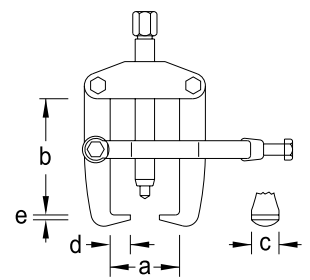

a <sub>max</sub>	b	max. t		mm	optional	c	d	e		Code	No.
90	85	5.0	M 18x1,5 x 130	19	–	22	12	3.0	1.6	8008050	1.20/1
90	100	5.0	M 18x1,5 x 130	19	–	24	15	3.0	1.7	8008130	1.20/2
150	140	7.5	G 1/2 x 175	22	1.06/HSP1	30	18	3.5	3.4	8008210	1.20/3

# 1.22 PULLER

with clamping yoke

- > Double-ended hooks
- > Particularly suitable for separating and removing flush-seated parts
- > Especially economical as it covers a range of different sizes

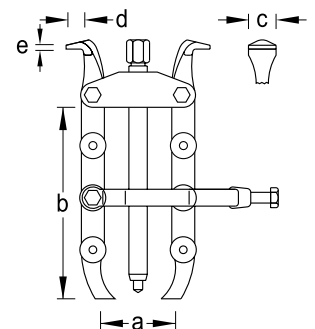

a <sub>max</sub>	b	max. t		mm	optional	c	d	e		Code	No.
110	170	5.0	M 18x1,5 x 200	19	–	25	14	3.5	2.2	8009020	1.22/1
160	260	7.5	G 1/2 x 350	22	1.06/HSP1	25	14	3.5	4.4	8009100	1.22/2
160	325	7.5	G 1/2 x 350	22	1.06/HSP1	25	14	3.5	4.6	8009290	1.22/3

## Hydraulic implements

### 1.50 HYDRAULIC IMPLEMENTS

- > Suitable for pressing, straightening, lifting, bending, and pulling
- > Consisting of hydraulic hand pump no. 1.50/1 and hydraulic cylinder no. 1.51
- > Simple oil filler - can be directly used



consisting of:	max. bar		Code	No.
<b>Hydraulic hand pump 1.50/1</b> <b>Hydraulic cylinder 1.51/10</b>	700	14.0	8110410	1.50/10
<b>Hydraulic hand pump 1.50/1</b> <b>Hydraulic cylinder 1.51/11</b>	700	15.0	8110680	1.50/11

### 1.50/1 HYDRAULIC HAND PUMP

- > Complete with 1.50 m high-pressure hose
- > To fit hydraulic cylinder 1.51
- > Incl. fitting and dust cover
- > Simple oil filler - can be directly used



for hydraulic cylinder	max. bar		Code	No.
<b>1.51/10 1.51/11</b>	700	8.3	8022710	1.50/1

# 1.51 HYDRAULIC CYLINDER

- > Connection of the coupling 3/8"
- > Incl. fitting and dust cover
- > Simple oil filler - can be directly used

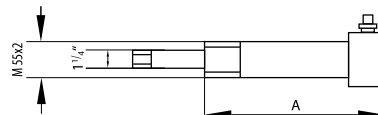

Stroke height	max. t	max. bar	A	kg	Code	No.
<b>150</b>	10	700	275	5.0	8023440	1.51/10
<b>230</b>	10	700	355	6.0	8110760	1.51/11

# 1.51/V EXTENSION FOR 1.51/10 + 11

- > 1.51/V015 are used to protect the cylinder/piston
- > The 1.51/V045, 1.51/V125 and 1.51/V205 extensions are attached to the hydraulic cylinder using adapter 1.51/A-2



Description	kg	Code	No.
<b>Extension and cylinder protection, 15 mm</b>	0.4	2065045	1.51/V015
<b>Extension for hydraulic cylinder, 45 mm</b>	0.5	2065053	1.51/V045
<b>Extension for hydraulic cylinder, 125 mm</b>	0.9	2065061	1.51/V125
<b>Extension for hydraulic cylinder, 205 mm</b>	1.3	2065088	1.51/V205
<b>Adaptor for 1.51/V045 - V205</b>	0.5	2065096	1.51/A-2

# HYDRAULIC IMPLEMENTS

- > As the puller cannot be rotated during extraction, pulling with the assistance of hydraulic aids - hydraulic implements, hydraulic spindle or hydraulic press - saves both on time and the effort needed.
- > The hydraulic implements can also be used with the 1.07/4 and 1.07/4A pullers.

5.10

>455





Remember the safety cover!

# 1.06/H PULLER

for hydraulic implement 1.50

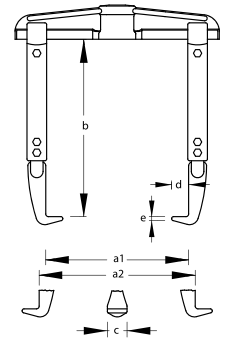
- > For the fast and damage-free removal of pulleys, wheels, ball bearings, etc.
- > Robust pattern, designed for rigidity and heavy duty use
- > By reversing the legs, this tool can be used as an internal or external puller
- > The reach may be increased both by using pulling legs in special lengths, and by using extensions





$a_1$	$a_{2min}$	$a_{2max}$	b	max. t	c	d	e		Code	No.
520	185	600	200	10.0	36	28	6.5	11.0	8112620	1.06/40

# 1.17/H PULLER

for hydraulic implement 1.50

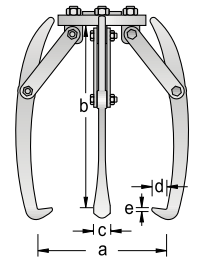
- > Heavy-duty pattern for the removal of gear wheels, spoked wheels, pulleys, etc
- > The legs grip automatically
- > For the assembly of a 2- or 3-arm puller





$a_{max}$	b	max. t	c	d	e		Code	No.
300	300	12	36	19	3.5	9.1	8007590	1.17/10
425	425	12	36	22	3.5	12.4	8109670	1.17/20

# 1.15/H PULLER

for hydraulic implement 1.50

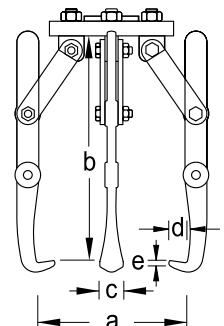
- > Heavy-duty pattern for the removal of gear wheels, spoked wheels, pulleys, etc.
- > The legs grip automatically
- > The adjustable reach means that this puller is very versatile
- > For the assembly of a 2- or 3-arm puller



$a_{max}$	b	max. t	c	d	e		Code	No.
250	260	12	32	18	3.5	9.0	8006860	1.15/30
280	390	12	32	20	3.5	9.2	8109590	1.15/40



## Separators

# SEPARATOR PULLERS 1.38 AND 1.40



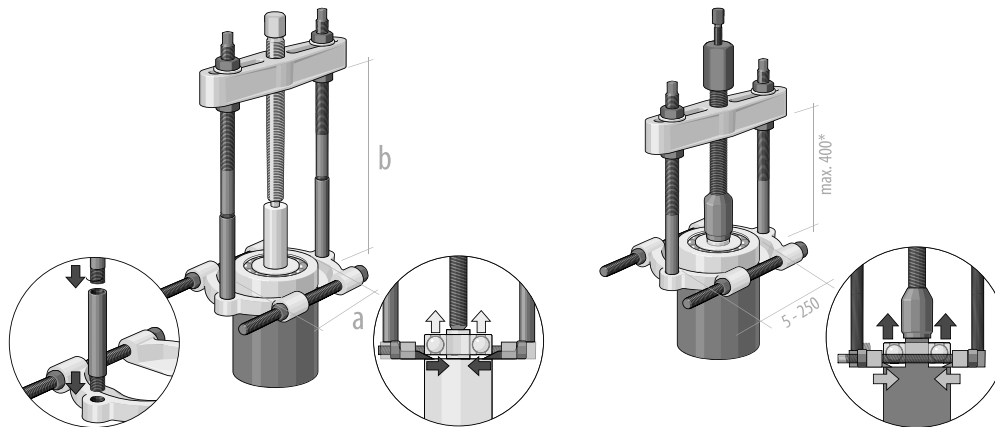

- > GEDORE separating blades are particularly suited for removing taper roller and ball bearings, inner bearing races and other tightly-seated or thin-walled parts.
- > To remove tightly-seated parts, the sharp edges of the separator blades are pressed behind the part to be removed which is then withdrawn using the correct 1.38 separator puller.
- > To avoid damage to delicate parts, the flat surfaces of the separator blades are used. This produces a large contact surface that prevents tilting.
- > The clamping reach can be enlarged with the aid of the 1.38/AV - FV tension bolt extensions.

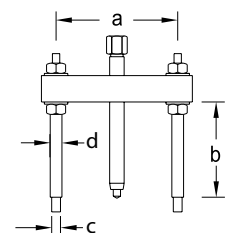

## 1.38 SEPARATOR PULLER

- > These separator pullers are used together with the bearing separators 1.40
- > The tension bolts are screwed into the threaded holes in the bearing separators



a	b	for separator		 mm	optional 	C / D		Code	No.
<b>40-120</b>	125	1.40/0	M 14 x 120	17	–	M10 / M12x1,5	1.0	8017550	1.38/0
<b>60-165</b>	180	1.40/1	M 18 x 170	19	–	M10 / M14x1,5	1.1	8017630	1.38/1
<b>70-215</b>	195	1.40/2	G 1/2 x 210	22	1.06/HSP1	M14x1,5 / M16x1,5	3.4	8017710	1.38/2
<b>90-300</b>	205	1.40/3	G 3/4 x 280	27	1.06/HSP2	M18x1,5 / M20x1,5	6.5	8017980	1.38/3
<b>125-380</b>	275	1.40/4	G 1 x 310	36	1.06/HSP3	M22x1,5 / M24x1,5	11.6	8018010	1.38/4
<b>140-440</b>	320	1.40/5	G 1 x 360	36	1.06/HSP3	M24x1,5 / M26x1,5	16.6	8018280	1.38/5



## 1.38/V EXTENSION ROD

› Extension rods for separator pullers 1.38



for separator	C	l mm	kg	Code	No.
<b>1.38/0 1.38/1</b>	M10	100	0.3	8018440	1.38/AV
<b>1.38/2</b>	M14x1,5	100	0.3	8018520	1.38/CV
<b>1.38/3</b>	M18x1,5	100	0.6	8018600	1.38/DV
<b>1.38/4</b>	M22x1,5	200	2.1	8018790	1.38/EV
<b>1.38/5</b>	M24x1,5	200	2.7	8018870	1.38/FV

## 1.40 SEPARATOR

- › For removing taper roller and ball bearings, inner bearing races, and other tightly-seated or thin-walled parts
- › Operation: To remove tightly-seated parts, the sharp edges of the separator blades are pressed behind the part and it is then withdrawn using the correct puller no. 1.38. To avoid damage to delicate parts, the flat surfaces of the separator blades are used. This produces a large support surface that prevents deformation.

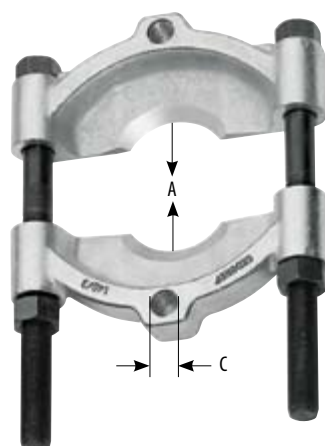

A mm	for puller	C	kg	Code	No.
<b>5-60</b>	1.38/0	M10	0.5	8019680	1.40/0
<b>12-75</b>	1.38/1	M10	0.9	8019760	1.40/1
<b>22-115</b>	1.38/2	M14x1,5	2.4	8019840	1.40/2
<b>30-155</b>	1.38/3	M18x1,5	4.7	8019920	1.40/3
<b>30-200</b>	1.38/4	M22x1,5	8.9	8020180	1.40/4
<b>30-250</b>	1.38/5	M24x1,5	15.3	8020260	1.40/5



# 1.41 SEPARATOR AND PULLER SET

- > Set comprising separator, puller, and extension rods
- > In sheet metal case

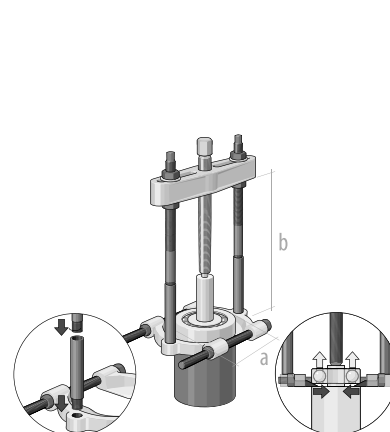

a	b	Contents		Code	No.
5-60	225	1.38/0 1.38/AV 1.40/0	2.8	8109750	1.41/0
12-75	280	1.38/1 1.38/AV 1.40/1	5.2	8109830	1.41/1
22-115	295	1.38/2 1.38/CV 1.40/2	9.0	8109910	1.41/2
30-155	305	1.38/3 1.38/DV 1.40/3	16.0	8110090	1.41/3
30-200	475	1.38/4 1.38/EV 1.40/4	28.6	8110170	1.41/4

**NEW**

# 1100-1.41/2A SEPARATOR AND PULLER SET

in L-BOXX® 136

- > For clamping depths from Ø 22 to 115 mm and clamping reach up to 295 mm
- > Incl. threaded inserts for internal threads M8-M18
- > For loosening and pulling tightly-seated parts e.g. taper roller bearings and inner bearing races
- > The clamping reach can be extended with extension rods 1.38/AV-FV from 195 to 295 mm
- > 1100 CT2-1.41/2A to retrofit existing L-BOXX®es 136
- > With Check-Tool insert for quick check of completeness
- > As tools are fully sunk in the foam, the equipped insert can be stacked
- > Insert for use in drawers with min. dimensions 400 x 310 x 60 mm



1100-1.41/2A



1100 CT2-1.41/2A

	Code	No.
11.5	2927284	1100-1.41/2A
7.9	2927292	1100 CT2-1.41/2A

Description		Code	No.
Foam insert 2/2 L-BOXX 136, empty	0.200	2927306	EI-1100 CT2-1.41/2A

## Ball bearing extractors

### 1.92 EXTRACTOR

Better solutions through innovative and precise technology

- > The solution for ball bearings, which are mounted on a shaft or in a housing, and thus cannot be extracted neither from the inside nor from the outside.
- > Extracting without drilling open the ball bearing! Therefore no risk of any chippings in machines.
- > In view of the different ball bearing constructions dependent on manufacturer, the table presented can only serve as an orientation guide in selecting the legs and heads.
- > The puller legs suggested in the tables are not mandatory. They only represent a recommendation based on the specifications of reputable ball bearing manufacturers.
- > **The "inner functioning" (cage, diameters of the rolling elements and their number) of a bearing is not standardized.**
- > If a hook does not fit, then choose the next larger / smaller hook.
- > Head sectioning is based on the number of rolling elements.
- > In practise this means that whilst a puller leg fits into bearing 6403 of manufacturer X, it does not with the same 6403 bearing of manufacturer Y. This is because manufacturer Y installs one ball more than manufacturer X.

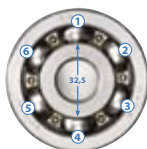

left 7 balls / right 6 balls

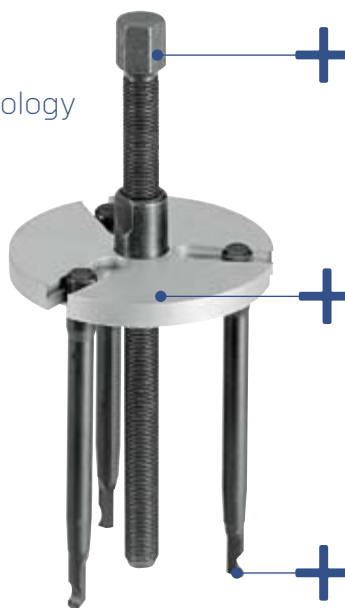

The innovative design with its maximum level of functionality in connection with simple handling provides a PLUS in effectivity and productivity.

The top plate is easy to use. The legs are fixed in the slot.

The self-locking system guarantees 100% force transmission and the maximum safety during withdrawal

#### FIELDS OF APPLICATION

Suitable for more than 40 standard ball bearings up to 6311



### 1.92 BALL BEARING EXTRACTOR PLUS

- > Using the ball bearing extractor, the removal of shaft-mounted ball bearings in a housing is now possible without any problems
- > Due to its great degree of functionality combined with the simplified handling, this design makes a PLUS in effectiveness and productivity possible
- > This tool is easy to use: The legs are fixed in the slot
- > The self-locking arrangement means that the force applied is 100 % utilised
- > Secure at all times against slipping off - and a straight pulling force for precise working
- > Suitable for more than 40 standard ball bearings up to 6311
- > 1.92/1 for bearings: 6000-6010, 6200-6205, 6300-6304
- > 1.92/2 for bearings: 6011-6012, 6206-6212, 6305-6311, 6403-6407
- > 1.92/12 for bearings: 6000-6012, 6200-6212, 6300-6311, 6403-6407

- \* with supporting ring 6309
- \*\* with supporting ring 6310
- \*\*\* with supporting ring 6311





Bearing	Leg	Head size		Code	No.
6000	1.92/10	192/1-7	2.3	1553534	1.92/1
6001	1.92/10	192/1-4			
6002	1.92/10	192/1-3			
6003	1.92/10	192/1-4			
6004	1.92/30	192/1-3			
6005	1.92/30	192/1-3			
6006	1.92/30	192/1-3			
6007	1.92/40	192/1-3			
6008	1.92/40	192/1-3			
6009	1.92/40	192/1-3			
6010	1.92/40	192/1-3			
6200	1.92/10	192/1-4			
6201	1.92/20	192/1-7			
6202	1.92/20	192/1-4			
6203	1.92/30	192/1-4			
6204	1.92/40	192/1-4			
6205	1.92/40	192/1-3			
6300	1.92/30	192/1-3			
6301	1.92/40	192/1-3			
6302	1.92/40	192/1-7			
6303	1.92/40	192/1-7			
6304	1.92/40	192/1-7			

Bearing	Leg	Head size		Code	No.
6011	1.92/50	192/2-3	5.2	1553542	1.92/2
6012	1.92/50	192/2-3			
6206	1.92/50	192/2-3			
6207	1.92/50	192/2-3			
6208	1.92/60	192/2-3			
6209	1.92/60	192/2-3			
6210	1.92/60	192/2-3			
6211	1.92/60	192/2-3			
6212	1.92/70	192/2-3			
6305	1.92/60	192/2-7			
6306	1.92/60	192/2-4			
6307	1.92/60	192/2-4			
6308	1.92/70	192/2-4			
6309	1.92/70	192/2-4			
6310***	1.92/70	192/2-4			
6311***	1.92/70	192/2-4			
6403	1.92/60	192/2-3			
6404	1.92/70	192/2-3			
6405	1.92/70	192/2-7			
6406	1.92/70	192/2-7			
6407*	1.92/60	192/2-7			
<b>Contents of set 1.92/1 and 1.92/2</b>			7.6	1553550	1.92/12

# 1.92 PARTS

- > Pulling legs No. 1.92/10 to 1.92/70 = set of 4 pieces
- > For spindle 1.1406200: please also order adaptor 192/A-2

Description		Code	No.
<b>Leg 120 mm</b>	0.170	1583263	1.92/10
<b>Leg 125 mm</b>	0.180	1583271	1.92/20
<b>Leg 130 mm</b>	0.190	1583298	1.92/30
<b>Leg 135 mm</b>	0.200	1583301	1.92/40
<b>Leg 140 mm</b>	0.310	1583328	1.92/50
<b>Leg 145 mm</b>	0.340	1583336	1.92/60
<b>Leg 150 mm</b>	0.470	1583344	1.92/70
<b>Head small 3 slots</b>	0.170	1574485	192/1-3

Description		Code	No.
<b>Head small 4 slots</b>	0.170	1574493	192/1-4
<b>Head small 3/7 slots</b>	0.170	1574507	192/1-7
<b>Head big 3 slots</b>	0.830	1574515	192/2-3
<b>Head big 4 slots</b>	0.800	1574523	192/2-4
<b>Head big 3/7 slots</b>	0.830	1574531	192/2-7
<b>Adaptor for head big 1.92/2</b>	0.048	1574566	192/A-2
<b>Spindle small for 1.92/1</b>	0.090	1576208	1.1006170
<b>Spindle big for 1.92/2</b>	0.220	1576224	1.1406200

# 1101-1.29/1K BALL BEARING EXTRACTOR SET

**NEW**

in i-BOXX® 72

- > Ball bearing extractor set for more than 30 ball bearings
- > For removing ball bearings that are both on a shaft and in a housing
- > Non-destructive removal of deep-groove ball bearings without dismantling the shaft; no necessity to drill open the bearing cage (no chippings)
- > With Check-Tool insert for quick check of completeness
- > Insert for use in drawers with min. dimensions 340 x 260 x 60 mm
- > In GEDORE i-BOXX® 72 No. 1101 L
- > Dimensions: W 367 x D 316 x H 72 mm



1101-1.29/1K

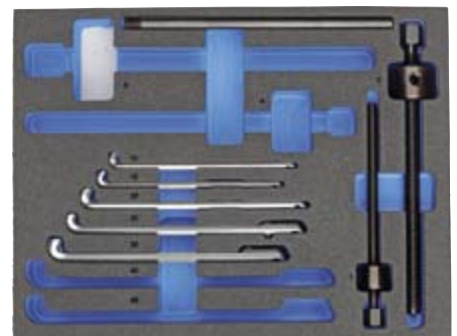

1101 CT-1.29/1K

for ball bearing No.	Contents		Code	No.
<b>6000 6001 6002 6003 6004 6005 6006 6007 6008 6009 6010 6011 6012 6200 6201 6202 6203 6204 6205 6206 6207 6300 6301 6302 6303 6304 6305 6306 6307 6403 6404</b>	2 Heads with spindle no. 1.29/1 + 1.29/3 5 Heads with spindle no. 1.29/10 - 1.29/35 1 Handle no. 1.29/0	2.610	2963485	1101-1.29/1K
	2 Heads with spindle no. 1.29/1 + 1.29/3 5 Heads with spindle no. 1.29/10 - 1.29/35 1 Handle no. 1.29/0	1.750	2964414	1101 CT-1.29/1K

Description		Code	No.
<b>Foam insert i-BOXX 72, empty</b>	0.110	2964449	EI-1101 CT-1.29/3K

**NEW**

# 1101-1.29/3K

## BALL BEARING EXTRACTOR SET

in i-BOXX® 72

- > Ball bearing extractor set for more than 40 ball bearings
- > For removing ball bearings that are both on a shaft and in a housing
- > Non-destructive removal of deep-groove ball bearings without dismantling the shaft; no necessity to drill open the bearing cage (no chippings)
- > With Check-Tool insert for quick check of completeness
- > Insert for use in drawers with min. dimensions 340 x 260 x 60 mm
- > In GEDORE i-BOXX® 72 No. 1101 L
- > Dimensions: W 367 x D 316 x H 72 mm



1101-1.29/3K

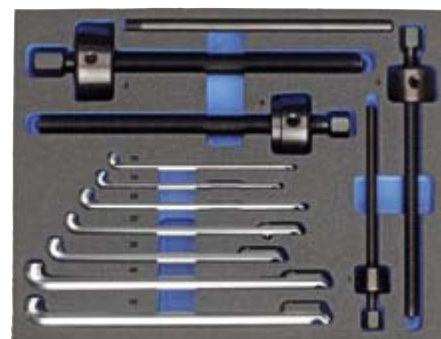

1101 CT-1.29/3K

for ball bearing No.	Contents	 kg	Code	No.
6000 6001 6002 6003 6004 6005 6006 6007 6008 6009 6010 6011 6012 6200 6201 6202 6203 6204 6205 6206 6207 6208 6209 6210 6211 6212 6213 6300 6301 6302 6303 6304 6305 6306 6307 6308 6309 6310 6311 6403 6404 6405 6406 6407	4 Heads with spindle no. 1.29/1 - 1.29/5 7 Heads with spindle no. 1.29/10 - 1.29/45 1 Handle no. 1.29/0	5.780	2964392	1101-1.29/3K
	4 Heads with spindle no. 1.29/1 - 1.29/5 7 Heads with spindle no. 1.29/10 - 1.29/45 1 Handle no. 1.29/0	4.920	2964430	1101 CT-1.29/3K



Description	 kg	Code	No.
Foam insert i-BOXX 72, empty	0.110	2964449	EI-1101 CT-1.29/3K

## 1.29

### BALL BEARING EXTRACTOR

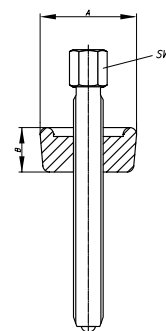
- > For removing ball bearings that are both on a shaft and in a housing
- > The legs selected using the table are inserted into the ball race, evenly distributed in the outer ring according to the number of balls
- > The support rings supplied for the ball bearings to be removed are placed on the bearings' inner races
- > The head with spindle is then placed on the centering depression of the shaft and the spindle put under tension with the legs
- > Delivery contains head and spindle. Please order suitable legs separately!



for leg	A	B		 mm	 kg	Code	No.
1.29/10-35	28	20	M 10 x 160	14	0.2	8011000	1.29/1
1.29/25-40	40	28	M 14 x 210	17	0.6	8011270	1.29/3
1.29/35-45	50	30	M 18 x 230	19	0.9	8011350	1.29/4
1.29/45	65	30	M 20 x 235	22	1.9	8011430	1.29/5



# 1.29 SET OF PULLING LEGS

4 pieces



1.29/10 - 1.29/25



1.29/30 - 1.29/45

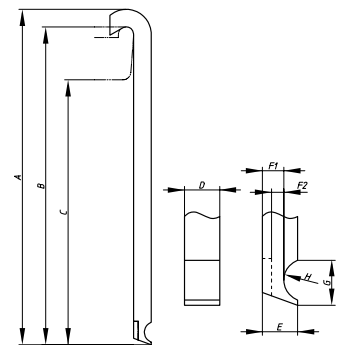

No.	Code	for ball bearing No.	for extractor	A	B	C	D	E	F1	F2	G	H	kg
<b>1.29/10</b>	8011510	6000 6001 6002 6003 6200	1.29/1	145	141	121	4.5	4	2,5	2,5	7.7	R4	0.062
<b>1.29/15</b>	8011780	6004 6005 6006 6201 6202 6300	1.29/1	145	140	120	5.7	5	3,0	3,0	8.8	R4	0.098
<b>1.29/25</b>	8011940	6204 6205 6301 6302 6007 6008 6300 6301 6302	1.29/1 1.29/3	176	170	150 142	6.7	6	3,7	3,7	9.8	R4	0.172
<b>1.29/30</b>	8012080	6303 6304 6009 6010 6011 6012 6204 6205 6206 6303 6304 6009 6010	1.29/1 1.29/3 1.29/4	186	179	159 151 149	7.9	7	4,4-6,1	4,4	10.3	R5	0.256
<b>1.29/35</b>	8012160	6305 6207 6305 6403 6011 6012	1.29/1 1.29/3 1.29/4 1.29/5	186	178	158 150 148 148	9.0	8	4,8-7,3	4,8	11.8	R5	0.342
<b>1.29/40</b>	8012240	6306 6307 6404 6208 6209 6210 6307	1.29/3 1.29/4	237	227	199 197	11.3	10	6,4-8,9	6,4	13.1	R6	0.646
<b>1.29/45</b>	8110250	6211 6308 6309 6405 6406 6407 6211 6212 6213 6309 6310 6311	1.29/4 1.29/5	237	227	197 197	11.3	10	6,1-11,6	6,1	14.7	R6	0.682

5.10

>455



Remember the safety cover!











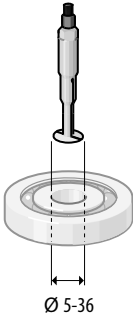
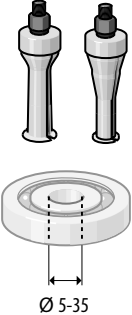
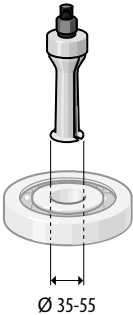
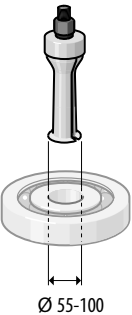
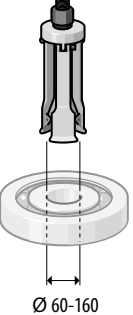

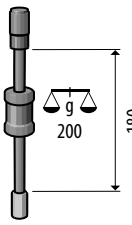



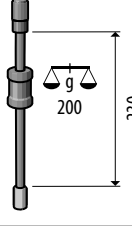



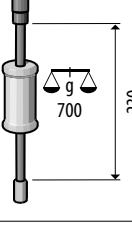





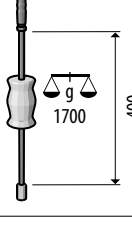

1101-1.29/3K

>60

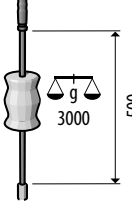

# INTERNAL EXTRACTOR OVERVIEW

with matching counter-stays and sliding hammers

	No. 1.34/1-4	No. 1.30/0-5 No. 1.30/2N-3N	No. 1.30/6-7	No. 1.30/8-9	No. 1.30/10 No. 1.30/10N	
						
						
No. 1.35/0 	 					 No. 1.36/1
No. 1.35/1 						 No. 1.36/2
No. 1.35/1A 			 			 No. 1.36/3
No. 1.35/2 			 	 		 No. 1.36/4
No. 1.35/3 					 + Adaptor 135/325-1 (Code: 1123750)	





## Internal extractors

### INTERNAL EXTRACTOR OVERVIEW

In a class of its own due to the precision manufacturing technology

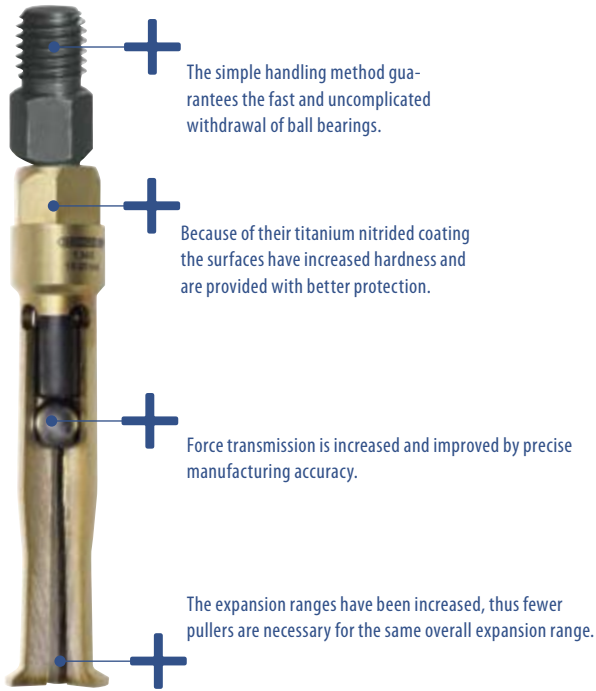

The simple handling method guarantees the fast and uncomplicated withdrawal of ball bearings.

Because of their titanium nitrided coating the surfaces have increased hardness and are provided with better protection.

Force transmission is increased and improved by precise manufacturing accuracy.

The expansion ranges have been increased, thus fewer pullers are necessary for the same overall expansion range.

> with matching counter-stays and sliding hammers

#### Contents:

- > 1.34/10 - 5-piece internal extractor set for closely-fitting ball bearings
- > Attractive set arrangement
- > Can be used with sliding hammer or counter-support brace



### FEATURES MATERIAL

#### Titanium nitrided surface

- > Harder
- > More wear-resistant
- > Better surface protection
- > More heat-resistant
- > Fine design
- > Fast compensation of temperature differences

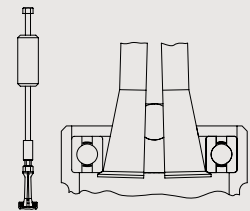

### 1.34/1 - 1.34/4 INTERNAL EXTRACTOR

- > For use with sliding hammer no. 1.35/0 or counter-support brace no. 1.36/1
- > Multiple wrench size (11 + 13 mm)



Ø mm	M	kg	Code	No.
5,0-8,5	M10	0.040	1638556	1.34/1
8,0-15,0	M10	0.060	1638564	1.34/2
15,0-25,0	M10	0.080	1638572	1.34/3
25,0-36,0	M10	0.100	1638580	1.34/4

### 1.34/10 INTERNAL EXTRACTOR SET

#### 5 pieces

- > For tightly-fitting ball bearings, bearing races, bushings and shaft seals
- > Titanium-nitrided surface
- > Multiple wrench size (11 + 13 mm)
- > M10 connecting thread
- > Operation: The internal extractor is inserted into the bearing and the spindle screwed in. The sharp turned-out shoulders of the pulling shell jaws will press outwards behind the part to be extracted. The counter-support brace or the sliding hammer is then added.
- > In plastic case

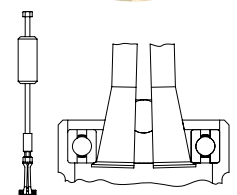

Contents	kg	Code	No.
1 internal extractor 5-8.5 mm, No. 1.34/1	1.3	1638629	1.34/10
1 internal extractor 8-15 mm, No. 1.34/2			
1 internal extractor 15-24 mm, No. 1.34/3			
1 internal extractor 25-36 mm, No. 1.34/4			
1 sliding hammer, No. 1.35/0			

## 1.30/0-9 INTERNAL EXTRACTOR

- > For extremely-tightly-packed ball bearings, bearing races, bushings, and shaft seals Simmering®
- > Operation: The internal extractor is inserted into the bearing and the spindle screwed in. The sharp turned-out shoulders of the pulling shell jaws will press outwards behind the part to be extracted. The counter-support brace is then added. Both feet must be aligned parallel to the spindle to ensure rigidity.
- > The design can vary from the image
- > Can be used with either sliding hammer or counter-support brace



⌀ mm min - max	M	● mm	⌘	Sliding hammer	⚖ kg	Code	No.
5-8	M10	10	1.36/1	1.35/1A	0.120	8012750	1.30/0
8-12	M10	10	1.36/1	1.35/1A	0.120	8012830	1.30/1
12-15	M10	10	1.36/1	1.35/1A	0.130	8012910	1.30/2
15-19	M10	13	1.36/1	1.35/1A	0.170	8013130	1.30/3
19-25	M10	13	1.36/1	1.35/2	0.200	8013480	1.30/4
25-30	M10	13	1.36/1	1.35/2	0.300	8013560	1.30/4A
30-35	M10	13	1.36/1	1.35/2	0.400	8013640	1.30/5
35-45	M14x1,5	17	1.36/2	1.35/2	0.650	8013720	1.30/6
45-55	M14x1,5	17	1.36/2	1.35/3	0.800	8013800	1.30/7
55-70	M14x1,5	19	1.36/3	1.35/3	1.800	8013990	1.30/8
70-100	M14x1,5	27	1.36/3	1.35/3	3.050	8014020	1.30/9

## 1.30/N INTERNAL EXTRACTOR

with reinforced shoulder

- > Especially suitable for the safe and trouble-free extraction of needle roller bearings, ball bearings and brass sleeves from crankshafts
- > Note: The shoulder of the shell jaw must be applied behind the bearing



⌀ mm	M	● mm	⚖ kg	Code	No.
12-14	M10	10	0.170	8013050	1.30/2N
14-19	M10	13	0.170	8013210	1.30/3N

1.35

>483



1.36

>483



# 1.30/10 INTERNAL EXTRACTOR

- > Suitable for removing large ball bearings and bearing outer races
- > Operation: The extraction jaws are spread by turning the nut. The newly-developed spreading system enables a simple, step-free and time-saving adjustment to the desired diameter to be made. The sharp-edged sections of the extraction jaws seat flush beneath when spread
- > Both internal extractors can be used with sliding hammer 1.35/3
- > Adapter 135/325-I M16x1,5 G 1/2" (Code 1123750) must also be ordered if sliding hammer 1.35/3 is used.



mm	M			mm	a	b	c	d	e	h1	h2	kg	Code	No.
60-160	G 1/2"	1.36/4	1.35/3	36	70	192	33	5	1	213	269	2.312	8014100	1.30/10
60-160	G 1/2"	1.36/4	1.35/3	36	70	187	33	5	6	213	269	2.312	2724804	1.30/10N

# 130/10 SPARE LEG FOR 1.30/10

- > One spare hook including screws
- > Suitable for 1.30/10 and 1.30/10N
- > Recommendation: In case of a broken hook, all three hooks should be replaced

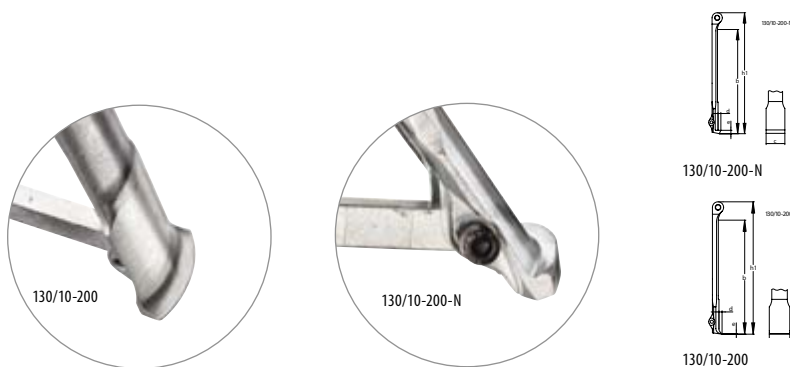

	b	c	d	e	h1	kg	Code	No.
1.30/10 1.30/10N	192	33	5	1	213	0.360	2827565	130/10-200
1.30/10N 1.30/10	187	33	5	6	213	0.360	2827573	130/10-200-N

1.81

>492



## 1.35 SLIDING HAMMER

- > Suited for the removal of small ball bearings since there is often not enough room for counter-support braces
- > Can also be used with threaded inserts no. 1.81



for internal extractors	M	with adaptor	mm	↳ mm	Sliding surface	Impact weight in g		Code	No.
1.34/1 - 1.34/4	M10	-	13	230	160	200	0.400	1958062	1.35/0
1.30/0 - 1.30/5	M10	-	13	270	200	200	0.450	8016070	1.35/1
1.34/1 - 1.34/4									
1.30/0 - 1.30/7	M10	M 14x1,5	13	270	200	700	0.950	1958070	1.35/1A
1.30/0 - 1.30/9	M 14x1,5	M10	24	520	340	1700	3.030	8039010	1.35/2
1.30/6 - 1.30/10	M 14x1,5	-	24	620	440	3000	4.200	1958089	1.35/3

## 1.36 COUNTER-SUPPORT BRACE

- > Operation: The counter-support brace is placed on the housing and the spindle screwed onto the spindle of the internal extractor. The toggle is held firmly, and the bearing extracted by tightening the nut.



for internal extractors	M	mm		Code	No.
1.30/0 - 1.30/5	M10	27	0.750	8016580	1.36/1
1.34/1 - 1.34/4					
1.30/6 - 1.30/7	M14x1,5	32	1.650	8016660	1.36/2
1.30/8 - 1.30/9	M14x1,5	32	3.000	8016740	1.36/3
1.30/10	G 1/2"	36	7.600	8016820	1.36/4

# 1.37/2 CYLINDER LINER PULLER

complete with support brace

- > Wet heavy-vehicle (e.g. Mercedes Benz, MAN) cylinder liners, automobile and stationary-engine liners, and other parts may be extracted using this puller
- > Operation: The spindle of the counter-support brace is screwed into the clamping nut of the puller, and the puller inserted into the liner. The counter-support brace is placed on to the cylinder block. Due to the newly-developed spreading system, when the spindle is turned, all three jaws spread quickly and without difficulty, until they are firmly seated beneath the edge of the liner. Then the nut of the counter-support brace is tightened.



mm	M	mm	kg	Code	No.
60-160	G 1/2"	36	6.8	8017200	1.37/2

# 1100-1.30 INTERNAL EXTRACTOR SET

in L-BOXX® 136, 7 pieces

- > For internal Ø 12 - 35 mm
- > For extremely-tightly-packed ball bearings, bearing races, bushings, and shaft seals Simmering®
- > Sliding hammer 1.7 kg and counter-support brace
- > 1100 CT2-1.30 to retrofit existing L-BOXX®es 136
- > With Check-Tool insert for quick check of completeness
- > As tools are fully sunk in the foam, the equipped insert can be stacked
- > Insert for use in drawers with min. dimensions 400 x 310 x 60 mm



1100 CT2-1.30



1100-1.30

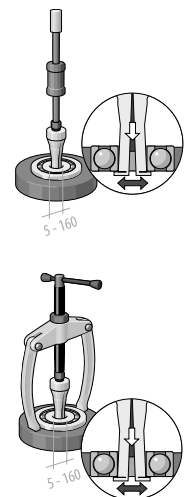

Contents	kg	Code	No.	Contents	kg	Code	No.
1.30/2	7.2	2836041	1100-1.30	1.30/2	5.0	2836025	1100 CT2-1.30
1.30/3				1.30/3			
1.30/4				1.30/4			
1.30/4A				1.30/4A			
1.30/5				1.30/5			
1.36/1				1.36/1			
1.35/2				1.35/2			
+ 1100 L							

Description	kg	Code	No.
Foam insert 2/2 L-BOXX 136, empty	0.200	2836033	EI-1100 CT2-1.30

## 1.31 INTERNAL EXTRACTOR SET

- > Sets comprise the most used extractor sizes for the removal of ball bearings, bearing races, bushings, shaft seals, etc.
- > In handy sheet metal case



1.31/0



1.31/2

Contents		Code	No.
<b>4 internal extractors 12-30 mm, No. 1.30/2 /3 /4 /4A</b> <b>1 counter-support brace No. 1.36/1</b>	2.6	8014530	1.31/0
<b>6 internal extractors 12-46 mm, No. 1.30/2 - /6</b> <b>2 counter-support braces No. 1.36/1 - /2</b>	6.4	8014610	1.31/1
<b>8 internal extractors 12-70 mm, No. 1.30/2 - /8</b> <b>2 counter-support braces No. 1.36/1 - /2</b>	9.2	8014880	1.31/2

## 1.32 SET OF INTERNAL AND EXTERNAL EXTRACTORS

- > The handy sheet metal case comprises internal extractors, support braces, pulling chucks, external extractors and stud extractors





1.32/1



1.32/2



1.32/2

Contents		Code	No.	Contents		Code	No.
<b>6 internal extractors 12-46 mm No. 1.30/2 - /6</b> <b>2 counter-support braces No. 1.36/1 - /2</b> <b>1 puller with extra slim legs No. 1.19/OXS</b> <b>1 battery-terminal puller No. 1.12/02</b> <b>1 puller, 2-arm pattern, No. 1.06/1</b>	10.4	8015260	1.32/1	<b>8 internal extractors 12-70 mm No. 1.30/2 - /8</b> <b>2 counter-support braces No. 1.36/1 - /2</b> <b>1 puller with extra slim legs No. 1.19/OXS</b> <b>1 battery-terminal puller No. 1.12/02</b> <b>2 pullers, 2-arm pattern, No. 1.06/1 1.06/2</b> <b>1 stud extractor No. 1.28/1</b>	19.0	8015340	1.32/2





## Wheel-hub Pullers

### 1.60 WHEEL-HUB PULLER

for cars and trucks

- > For wheel stud circles from 80 up to 225 mm
- > Easy to use
- > Upgradeable with hydraulic spindle no. 1.06/HSP2
- > No. 1.60/H = Spare leg



No. of legs		optional 		Code	No.
3	G 3/4 x 200	1.06/HSP2	4.3	8024840	1.60/3
4	G 3/4 x 200	1.06/HSP2	4.8	8110840	1.60/4
5	G 3/4 x 200	1.06/HSP2	5.3	8024920	1.60/5



Description		Code	No.
<b>Spare leg</b>	0.5	8110920	1.60/H

### 1.61 WHEEL-HUB PULLER

for cars and trucks

- > For wheel stud circles up to 250 mm
- > With wheel stud protection using rotating nut apertures that always lie flat to the hub for Ø 22 mm and suitable reduction bushing Ø 14 and 18 mm
- > Easy to use
- > Upgradeable with hydraulic spindle no. 1.06/HSP2
- > No. 1.61/H = Spare leg



No. of legs		optional 		Code	No.
3	G 3/4 x 200	1.06/HSP2	4.6	8111060	1.61/3
4	G 3/4 x 200	1.06/HSP2	5.2	8111140	1.61/4
5	G 3/4 x 200	1.06/HSP2	5.8	8025300	1.61/5





Description		Code	No.
<b>Spare leg</b>	0.6	8111220	1.61/H

### 1.62 WHEEL-HUB PULLER

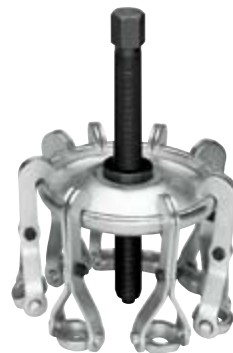
for trucks

- > For wheel stud circles from 150 up to 350 mm
- > With wheel stud protection using rotating nut apertures that always lie flat to the hub for Ø 22 mm and suitable reduction bushing Ø 14 and 18 mm
- > This tool may also be used with the hydraulic aid without requiring a reduction bushing
- > Upgradeable with hydraulic spindle no. 1.06/HSP3
- > No. 1.61/H = Spare leg



No. of legs			optional 		Code	No.
8	G 1 x 310	36	1.06/HSP3	12.6	8026030	1.62/8

Description		Code	No.
<b>Spare leg</b>	0.6	8111220	1.61/H

1.50

>469



1.06/HSP

>453





## Ball joint pullers

# BALL JOINT PULLER 1.73

Partner to rely on for your vehicle

- > Using the spindle, the ball joint puller is brought up to the required clamping height.
- > The set bolt applies that force needed to press out the ball joint. To withstand a load like this, the thread is rolled followed by hardening and tempering the spindle.
- > Body and lever of the 1.73 ball joint puller are drop-forged from 31CrV3 tempering steel and then hardened and tempered. In this way, the two major parts acquire the needed hardness and stability.
- > Article 1.73 comes in two sizes which together with their dimensions cover the most common pressure/force situations.
- > Other dimensions are covered by articles 1.72 and 1.74 - the compact 1.72 can be made use of, for instance, in extremely tight spots.

## SAFETY-RELEVANT



> Forces amounting to several tons in weight act on the puller during the extracting operation! Drop-forged components "announce" possible overloading by bending. This is due to the fibre

course of the material during forging permitting a certain flexibility of the components ahead of fracturing - an extremely "healthy" property, in fact!

## 1.72 BALL JOINT PULLER

- > For the simple and damage-free removal of ball pins on track rods and push rods





a	b	c				Code	No.
18	35	40	M 14x1,5 x 50	17	0.300	8030300	1.72/1
23	45	50	M 14x1,5 x 50	17	0.400	8030490	1.72/2
27	56	60	M 18x1,5 x 80	19	0.700	8030570	1.72/3
37	78	75	G 1/2 x 110	22	1.650	8030650	1.72/4
40	80	80	G 1/2 x 140	22	2.160	2183323	1.72/4A
46	100	90	G 3/4 x 160	27	2.780	2183331	1.72/5A

## 1.73 UNIVERSAL BALL JOINT PULLER

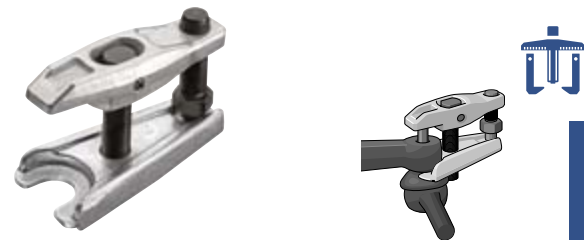
- > For removing ball joints on cars and trucks



	Clamping height	Fork depth		Code	No.
23	65	24	0.730	8030810	1.73/1
32	85	28	2.520	8033240	1.73/3

## 1.74 UNIVERSAL BALL JOINT PULLER

- > For removing the ball joint journals on track rods, stabilizers, etc.
- > Simple operation due to slender lower part and 2-stage lever position



1.74/1

1.74/2

	Clamping height	Fork depth		Code	No.
20	12-50	35	1.370	8085200	1.74/1
20	50-80	35	1.740	8085390	1.74/2

## Oil filter hook

### 1.75/1 OIL FILTER HOOK

3-arm pattern

- > For removing firmly seated oil filters and granulate cartridges of compressed air dryers with right-handed thread, e.g. Mercedes Benz, MAN
- > With 3/8" female square drive and adaptor 17 mm external



mm	kg	Code	No.
60-120	0.650	8117420	1.75/1

### 1.76/1 CARTRIDGE SPANNER

3-arm pattern

- > Especially suitable for removing firmly seated granulate cartridges of compressed air dryers on HGV, with right-handed or left-handed thread
- > Great clamping reach (from 95 to 165 mm)
- > The GEDORE cartridge spanner is also usable as oil filter key
- > Zinc-plated
- > Drive 1/2"



mm	"	mm	kg	Code	No.
95-165	1/2	12.5	1.420	1523651	1.76/1

## Special Automotive Tools

### 1.64 DRIVE SHAFT PULLER

- > Suitable for drive shafts with 4 or 5 apertures
- > For wheel stud circles 100-155 mm with 6 mm screws
- > For tapped holes up to max. M14
- > **Operation:** The puller is attached to the drive shaft flange using the nuts of the wheel bolts. By striking the spindle head with the sliding hammer, the shaft may be removed easily and without damage.



∅	kg	Code	No.
100-155	4.5	8026700	1.64/1

### 1.65 PULLING FLANGE

heavy-duty pattern

- > For wheels and discs with tapped holes up to M16
- > The flange is fitted with slots for hole pitches of 180, 120, and 90 degrees
- > Additional holes may be drilled to render the flange suitable for other pitches and aperture diameters
- > A very sturdy model for heavy parts and the highest requirements



G	kg	Code	No.
1.1/4 x 270	16.0	8027000	1.65/1

## 1.66 PULLING FLANGE

- > For wheels and discs with tapped holes up to M10
- > The flange is fitted with slots for hole pitches of 180 and 120 degrees
- > No. 1.66/1 plate and spindle without hooks
- > No. 1.66/11 with one pair each of long (135 mm) and short (85 mm) hooks and a protective cap for the thread of the steering column



Clamping reach				Code	No.
35-80	M 12 x 110	14	0.7	8027510	1.66/1
35-80	M 12 x 110	14	1.1	8027780	1.66/11

## 1.67 STEERING-WHEEL PULLER

for cars

- > Contains 1 pair of short legs, 1 pair of long legs, and a protective cap for the thread of the steering column



Clamping reach	Leg length up to				Code	No.
35-90	135	M 14x1,5 x 150	17	0.9	8028240	1.67/1

## 1.68 STEERING-WHEEL PULLER

- > Featuring 1 pulling ring each with 100 mm and 150 mm diameter for 3-spoke and 4-spoke steering wheels
- > To protect the steering-wheels, the pulling rings are fitted with sliding rubber sleeves



Leg length				Code	No.
120	M 18 x 170	19	2.0	8028750	1.68/1

## 1.70 DISMANTLING AND ASSEMBLY FORK

- > For fast removal of track rod and push rod ends, steering arms, and other steering parts
- > Also suitable for removing shock absorbers and other separating and dismantling work
- > The forks are suitable for use in the most confined spaces
- > Hammer blows on the handle ends are used to separate the parts

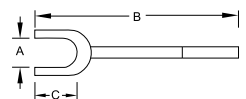

A	B	C		Code	No.
18	340	80	0.8	8029210	1.70/1
23	340	80	0.9	8029480	1.70/2
29	350	90	1.1	8029560	1.70/3
40	350	90	1.2	8029640	1.70/4
45	355	95	1.2	8085040	1.70/5



## Track alignment gauge

### 3.01 TRACK ALIGNMENT GAUGE

- › For inside measurement
- › With simple, telescopic length adjustment
- › Immediate track-difference readings may be taken from the millimetre scale
- › Extensive measurement range from 835 to 1500 mm, and with extensions up to 2100 mm
- › Track difference measurable from 0-35 mm
- › Notes on Use: The vehicle to be tested must be standing on level ground. The front wheels must be set for running straight ahead and have the same tyre pressure. The play in the steering linkage must be removed by pressing the front wheels apart. The track alignment gauge must be set roughly at the axle centre-line between the front tyres in such a manner that the two chain ends contact the ground. The scale is set a "0". The car is allowed to roll forward approx. one half turn of the wheel, until the chain ends again contact the ground. The track difference may then be read off on the scale.

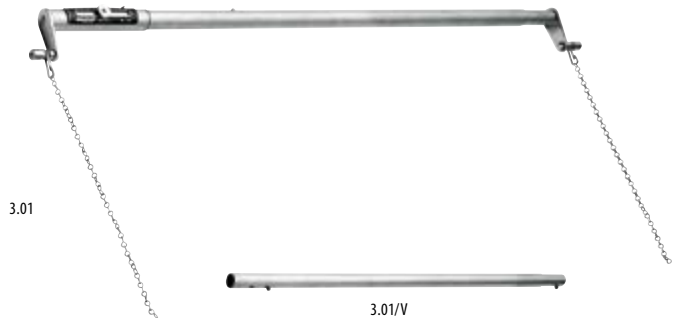

Description	Measurement range mm		Code	No.
<b>Track alignment gauge 835-1500 mm</b>	835-1.500	1.900	8033080	3.01
<b>Extension for track alignment gauge 1500-2100 mm</b>	1.500-2.100	0.570	8033160	3.01/V

## Spring compressor

### 1.78/S SAFETY COIL SPRING COMPRESSOR

- › For the safe installation and removal of coil springs with a diameter of 110-180 mm
- › **Safety note:** When the spindles are tightened evenly, the clamping heads grip the coils tightly, rendering sideways slip impossible
- › VPA-GS-tested safety

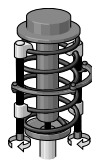

Clamping reach		Code	No.
<b>240</b>	2.2	8031380	1.78/S2
<b>340</b>	2.6	8031460	1.78/S3

### 1.78/P UNIVERSAL COIL SPRING COMPRESSOR

- › For MacPherson suspension strut and transverse link axles with spring diameters of 110-180 mm
- › The hooks are drop forged
- › The wide support rests are matched to the coil spring pitch
- › VPA-GS-tested safety
- › PK = with plastic cap



1.78/P1



1.78/PK1



Clamping reach	max. t		Code	No.
<b>240</b>	3.5	2.6	8111300	1.78/P1
<b>240</b>	3.5	2.5	8031030	1.78/PK1

### 1.79 SPRING SPREADER

- › Especially designed for VAG exhaust installations, where the pipe is not held by bolts to the exhaust manifold, but clamped on using springs



	Code	No.
<b>0.4</b>	8112540	1.79/1

### 1.91 TYRE REMOVING TOOL

- › For breaking the adhesion between truck tyres and wheel rims



$\text{H mm}$		Code	No.
<b>300</b>	2.0	8032270	1.91

## Accessories

### 1.26 NUT SPLITTER

- > For splitting jammed or stripped nuts without damaging the bolt thread
- > Suitable for nuts up to property class 6
- > With chisel stopper



for nuts		mm		Code	No.
<b>10-17 mm, M6-M10</b>	M 14x1,5 x 37	17	0.270	8009880	1.26/1
<b>17-24 mm, M10-M16</b>	M 14x1,5 x 37	17	0.300	8009610	1.26/2
<b>24-36 mm, M16-M24</b>	M 22x1,5 x 70	24	1.130	8010030	1.26/3

Description		Code	No.
<b>Spare chisel for 1.26/1 + /2</b>	0.040	2017016	1.26/M1
<b>Spare chisel for 1.26/3</b>	0.050	2017024	1.26/M3

### 1.26/HYD NUT SPLITTER

hydraulic

- > With strong chisel, additionally induction hardened
- > At the cutting edge for breakage resistance
- > The chamfer at the chisel's edge improves the splitting effect and prevents breakage
- > With smooth chisel function
- > Channel walls rolled, thus mirror-smooth and wear resistant
- > For nuts up to property class 10
- > Chisel replaceable



1.26/1 HYD



1.26/2 HYD

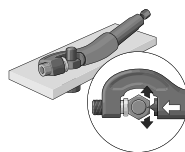

for nuts	mm	max. t		Code	No.
<b>7-22 mm, M4-M14</b>	12	5.0	0.800	8009450	1.26/1 HYD
<b>22-36 mm, M14-M24</b>	12	13.0	3.400	8009530	1.26/2 HYD

Description		Code	No.
<b>Spare chisel for 1.26/1 HYD</b>	0.020	2018586	1.26/M1 HYD
<b>Spare chisel for 1.26/2 HYD</b>	0.112	2043920	1.26/M2 HYD

### 1.90 FLANGE SEPARATORS

(pair)

- > For separating DIN standard flanges on pipes when changing seals and doing maintenance work
- > For Ø 80-250 mm and screw threads M16-M24
- > Use: Always use the separators in pairs and attach them to opposite sides of the flange. When the two spindles are turned alternately, the flanges will be separated from one another evenly. When the spindles are turned back alternately, this guarantees a perfect fitting of the flanges in their original position. Always use in pairs! Press in opposite directions at 180°!

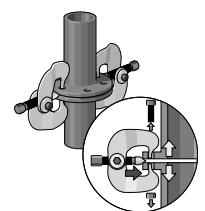

Ø	for screw threads		Code	No.
<b>80-250</b>	M16 - M24	5.5	1596403	1.90/1

### 1.26/K NUT SPLITTER SET

- > For nuts from size 10 mm (M6) to size 36 mm (M24), including spare chisel
- > With chisel stopper
- > In plastic case with Check-Tool insert



Contents		Code	No.
<b>1 nut splitter 10-17 mm, M6-M10, No. 1.26/1</b>	2.460	2017008	1.26/K-3
<b>1 nut splitter 17-24 mm, M10-M16, No. 1.26/2</b>			
<b>1 nut splitter 24-36 mm, M16-M24, No. 1.26/3</b>			
<b>1 spare chisel for 1.26/1 + /2, No. 1.26/M1</b>			
<b>1 spare chisel for 1.26/3, No. 1.26/M3</b>			

### 1.28 STUD EXTRACTOR

- > For removing damaged studs with right-handed or left-handed thread
- > Even suitable for extremely short stud ends



1.28/1 - 1.28/3



1.28/4

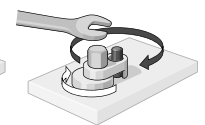
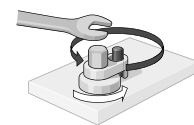

Ø-Stud	mm		Code	No.
<b>6-13</b>	19	0.230	8010620	1.28/1
<b>8-19</b>	19	0.300	8010700	1.28/2
<b>19-25</b>	19	0.400	8010890	1.28/3
<b>5-26</b>	19	0.600	1465031	1.28/4



# 1.81/1 + 2

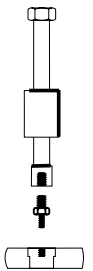

## SET OF THREADED INSERTS

for 1-hole uses

- > The threaded inserts make the removal of threaded caps, for example, possible, when these possess one threaded hole
- > No. 1.81/1: For sliding hammers 1.35/1, 1.35/2, counter-support brace 1.36/1
- > No. 1.81/2: For sliding hammers 1.35/2, 1.36/2, counter-support brace 1.36/3



Connecting thread 		Code	No.
<b>M10 - M4</b>	0.340	1120727	1.81/1
<b>M10 - M5</b>			
<b>M10 - M6</b>			
<b>M10 - M8</b>			
<b>M10 - M10</b>			
<b>M10 - M12</b>			

Connecting thread 		Code	No.
<b>M14x1,5 - M8</b>	0.490	1120743	1.81/2
<b>M14x1,5 - M10</b>			
<b>M14x1,5 - M12</b>			
<b>M14x1,5 - M14</b>			
<b>M14x1,5 - M16</b>			
<b>M14x1,5 - M18</b>			



# 1.81/10 + 20

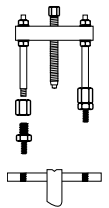
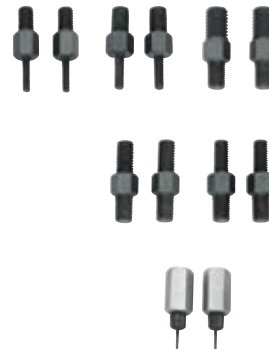

## SET OF THREADED INSERTS

for 1-hole and 2-hole uses, 2 each

- > The threaded inserts make the removal of threaded caps, for example, possible, when these possess one or two threaded holes
- > No. 1.81/10: For separator puller 1.38/0, 1.38/1
- > No. 1.81/20: For separator puller 1.38/2



Connecting thread 		Code	No.
<b>M10 - M4</b>	0.670	1120735	1.81/10
<b>M10 - M5</b>			
<b>M10 - M6</b>			
<b>M10 - M8</b>			
<b>M10 - M10</b>			
<b>M10 - M12</b>			

Connecting thread 		Code	No.
<b>M14x1,5 - M8</b>	1.222	1120751	1.81/20
<b>M14x1,5 - M10</b>			
<b>M14x1,5 - M12</b>			
<b>M14x1,5 - M14</b>			
<b>M14x1,5 - M16</b>			
<b>M14x1,5 - M18</b>			

# 1.81/K

## SET OF THREADED INSERTS

for 1-hole uses

- > The threaded inserts make the removal of threaded caps, for example, possible, when these possess one threaded hole
- > No. 1.81/K-1: With sliding hammer 1.35/1, rod 230 mm and impact weight 200 g
- > No. 1.81/K-12: With sliding hammer 1.35/1A, rod 230 mm and impact weight 700 g, adaptor M14x1,5
- > In robust plastic case, 275 x 229 x 83 mm







1.81/K-1

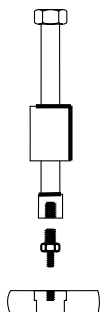

1.81/K-12



Connecting thread 		Code	No.
<b>M10 - M4</b>	1.000	1936549	1.81/K-1
<b>M10 - M5</b>			
<b>M10 - M6</b>			
<b>M10 - M8</b>			
<b>M10 - M10</b>			
<b>M10 - M12</b>			

Connecting thread 		Code	No.
<b>M10 - M4</b>	1.830	1936557	1.81/K-12
<b>M10 - M5</b>			
<b>M10 - M6</b>			
<b>M10 - M8</b>			
<b>M10 - M10</b>			
<b>M10 - M12</b>			
<b>M14x1,5 - M14</b>			
<b>M14x1,5 - M16</b>			
<b>M14x1,5 - M18</b>			

## Add-on systems

### 1.18/1.19 PULLER SET

- > This perforated panel offers place for 12 pullers of the series 1.18 and 1.19
- > For clamping depths up to  $\varnothing$  200 mm and clamping reach up to 200 mm
- > Delivery includes perforated panel



Contents			Code	No.
<b>2-arm Puller</b> 1.18/1 1.18/2 1.18/3	<b>2-arm-Fan puller</b> 1.18/0 1.18/01 1.18/02	21.0	1824007	1.18/1.19
<b>3-arm Puller</b> 1.19/1 1.19/2 1.19/3	<b>3-arm Fan puller</b> 1.19/0 1.19/01 1.19/02			

### 2.10 AUTOMOBILE WORKSHOP SET

#### Add-on system

- > 2- and 3-arm puller set
- > Clearly arranged module system
- > Everything at hand on perforated wall-board





Contents			Code	No.
<b>1 cross-beam, 2-arm pattern 140 mm, No. 106/103</b> <b>1 cross-beam, 3-arm pattern 140 mm, No. 107/103</b> <b>1 spindle 17 mm, M14x1.5, 140 mm, No. 1.1406140</b> <b>3 pulling legs 100 mm, No. 106/A-100-N</b> <b>3 pulling legs slim pattern 100 mm, No. 106/A-100-S</b>	<b>1 battery-terminal puller, 2-arm pattern 60x40 mm, No. 1.12/02</b> <b>1 nut splitter 17-24 mm, M10-M16, No. 1.26/2</b> <b>1 stud extractor 8-19 mm, No. 1.28/2</b> <b>1 dismantling and assembly fork 23 mm, No. 1.70/2</b> <b>1 universal ball joint puller 65x23 mm, No. 1.73/1</b> <b>1 oil filter hook 3-arm pattern 60-120 mm, No. 1.75/1</b>	13.3	1088696	2.10

### 2.20 TRUCK WORKSHOP SET

#### Add-on system

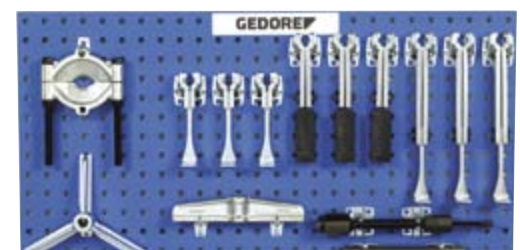
- > 2- and 3-arm puller set incl. separator
- > Clearly arranged module system
- > For clamping depths up to  $\varnothing$  200 mm external,  $\varnothing$  260 mm internal, and clamping reach up to 300 mm
- > With this set, you will be able to assemble 12 of the usual versions including hydraulic spindle, in seconds
- > 2-arm cross-beams with scale for uniform adjustment of the puller legs. Allows centred pulling, with optimised application of force, even when extremely high pulling forces are required
- > Everything at hand on perforated wall-board



Contents			Code	No.
<b>1 cross-beam, 2-arm pattern 260 mm, No. 106/2A03</b> <b>1 cross-beam, 3-arm pattern 260 mm, No. 107/2A03</b> <b>1 spindle 22 mm, G 1/2", 210 mm, No. 1.2106210</b> <b>1 hydraulic pressure spindle 10 t, No. 1.06/HSP1</b>	<b>3 pulling legs 150 mm, No. 106/B-150-N</b> <b>3 pulling legs slim pattern 220 mm, No. 106/B-220-S</b> <b>3 pulling legs slim pattern 220 mm, No. 106/B-220-S</b> <b>1 bearing separator 22-115 mm, No. 1.40/2</b>	23,3	1088718	2.20





## 2.30 INDUSTRIAL PULLING SET

### Add-on system

- > 2- and 3-arm puller set
- > For the assembly of the tried and tested 1.06 and 1.07 versions
- > For clamping depths up to Ø 200 mm external, Ø 260 mm internal, and clamping reach up to 150 mm
- > 2-arm cross-beams with scale for uniform adjustment of the puller legs. Allows centred pulling, with optimised application of force, even when extremely high pulling forces are required
- > Using this set, you will be able to assemble 12 of the usual versions with high-speed clamping legs, including hydraulic spindle, in seconds
- > Everything at hand on perforated wall-board



Contents			Code	No.
1 cross-beam, 2-arm pattern 140 mm, No. 106/103	1 spindle 17 mm, M14x1.5, 140 mm, No. 1.1406140	19.4	1393014	2.30
1 cross-beam, 2-arm pattern 180 mm, No. 106/1A03				
1 cross-beam, 2-arm pattern 220 mm, No. 106/203	1 spindle 22 mm, G 1/2", 210 mm, No. 1.2106210			
1 cross-beam, 2-arm pattern 260 mm, No. 106/2A03	1 hydraulic pressure spindle 10 t, No. 1.06/HSP1			
1 cross-beam, 3-arm pattern 140 mm, No. 107/103	3 quick-release pulling legs 100 mm, No. 106/A-100-E			
1 cross-beam, 3-arm pattern 180 mm, No. 107/1A03				
1 cross-beam, 3-arm pattern 220 mm, No. 107/203	3 quick-release pulling legs 150 mm, No. 106/B-150-E			
1 cross-beam, 3-arm pattern 260 mm, No. 107/2A03				

## 2.30-B INDUSTRIAL PULLING SET WITH LEG BRAKE

### Add-on system

- > 2- and 3-arm puller set
- > For the assembly of the tried and tested 1.06 and 1.07 versions
- > For clamping depths up to Ø 210 mm external as well Ø 260 mm internal, and clamping reach up to 150 mm
- > With this set, you will be able to assemble 12 of the usual versions with high-speed clamping legs, including hydraulic spindle, in seconds
- > 2-arm cross-beams with scale for uniform adjustment of the puller legs. Allows centred pulling, with optimised application of force, even when extremely high pulling forces are required
- > Leg brake prevents unintentional leg slipping. The leg can be slid along the cross-beam at the push of a button
- > Everything at hand on perforated wall-board



Contents			Code	No.
1 cross-beam, 2-arm pattern 140 mm, No. 106/103	1 spindle 17 mm, M14x1.5, 140 mm, No. 1.1406140	19.4	2017032	2.30-B
1 cross-beam, 2-arm pattern 180 mm, No. 106/1A03	1 spindle 22 mm, G 1/2", 210 mm, No. 1.2106210			
1 cross-beam, 2-arm pattern 220 mm, No. 106/203	1 hydraulic pressure spindle 10 t, No. 1.06/HSP1			
1 cross-beam, 2-arm pattern 260 mm, No. 106/2A03	3 pulling legs, all steel, leg brake 100 mm, No. 106/A-100-B			
1 cross-beam, 3-arm pattern 140 mm, No. 107/103				
1 cross-beam, 3-arm pattern 180 mm, No. 107/1A03	3 pulling legs, all steel, leg brake 150 mm, No. 106/B-150-B			
1 cross-beam, 3-arm pattern 220 mm, No. 107/203				
1 cross-beam, 3-arm pattern 260 mm, No. 107/2A03				

## 2.40 PULLING SET FOR CONSTRUCTION MACHINES

### Add-on system

- > 2- and 3-arm puller set
- > For the assembly of the robust and handy strap-pattern pulling tools 1.14 and 1.15
- > For clamping depths up to Ø 280 mm and clamping reach up to 390 mm
- > With this set, you will be able to assemble 10 of the usual flexible strap-pattern pulling tools from the range 1.14/1.15, including the new hydraulic spindle
- > Everything at hand on perforated wall-board



Inhalt			Code	No.
1 head 2-arm pattern No. 114/204	1 hydraulic pressure spindle 10 t, No. 1.06/HSP1	24,3	1393030	2.40
1 head 2-arm pattern No. 114/304	3 pulling legs 210 mm, No. 114/201			
1 head 3-arm pattern No. 115/204	3 pulling legs 260 mm, No. 114/301			
1 head 3-arm pattern No. 115/304	3 pulling legs 390 mm, No. 114/401			
1 spindle 19 mm, M18x1.5, 200 mm, No. 1.1806200	6 straps No. 114/208			
1 spindle 22 mm, G 1/2", 250 mm, No. 1.2106250	12 straps No. 114/308			

## 2.50

# SET OF INTERNAL AND EXTERNAL EXTRACTORS

- › Suitable for various applications of external or internal extraction
- › Internal extractors for bores with  $\varnothing$  5 - 55 mm. To use in connection with sliding hammer or counter-support braces
- › External extractors with various clamping depths up to 130 mm
- › Separators and pullers incl. extension rods, ideal for removing tightly-seated or thin-walled parts for outer diameter 5 - 115 mm
- › Everything at hand on perforated wall-board



Contents	 kg	Code	No.
1 internal extractor 5-8 mm, No. 1.30/0	29.0	2017040	2.50
1 internal extractor 8-12 mm, No. 1.30/1			
1 internal extractor 12-15 mm, No. 1.30/2			
1 internal extractor 15-19 mm, No. 1.30/3			
1 internal extractor 19-25 mm, No. 1.30/4			
1 internal extractor 25-30 mm, No. 1.30/4A			
1 internal extractor 30-35 mm, No. 1.30/5			
1 internal extractor 35-45 mm, No. 1.30/6			
1 internal extractor 45-55 mm, No. 1.30/7			
1 sliding hammer 230 mm, 700 g, No. 1.35/1A			
1 sliding hammer 500 mm, 1,7 kg, No. 1.35/2			
1 counter-support brace for 1.30/0 - 1.30/5, No. 1.36/1			
1 counter-support brace for 1.30/6 - 1.30/7, No. 1.36/2			
1 universal puller HIGH POWER 2-arm pattern 130x100 mm, No. 1.04/HP1A			
1 battery-terminal puller, 3-arm pattern 70x80 mm, No. 1.13/00			
1 puller 80x85 mm, No. 1.23/1S			
1 separator puller 40-120 mm, No. 1.38/0			
1 separator puller 70-215 mm, No. 1.38/2			
1 extension rod M10, No. 1.38/AV			
1 extension rod M14x1.5, No. 1.38/CV			
1 bearing separator 5-60 mm, No. 1.40/0			
1 bearing separator 22-115 mm, No. 1.40/2			

INDIVIDUAL WALL-BOARDS AVAILABLE ON REQUEST!



## SAFETY NOTES

### PULLERS

- › Read the operating instructions!
- › Use only original spare parts and accessories for your GEDORE puller. Never use worn, modified or defective spare parts or accessories.
- › Wear goggles and protective clothing when working. For added safety, use the GEDORE safety cover 5.10!
- › Before pulling, ensure that the legs are in contact with the part to be pulled and are firmly tightened so that the spindle operates centrally along the axis of the puller.
- › Attention! When using a puller, forces of up to several tons are generated! Take care to ensure that the puller is correctly positioned and is vertical to the component being pulled.
- › Do not use electric or pneumatic power or percussion drivers.

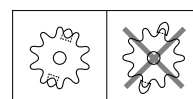
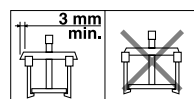
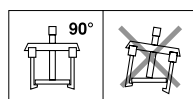
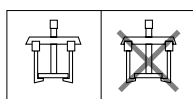
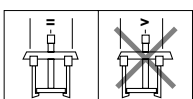



**GEDORE**  
ROTBAND-PLUS

# HAMMERS / STRIKING TOOLS

ENGINEERS' HAMMERS  
>503



CLUB HAMMERS  
>508



SLEDGE HAMMERS  
>510



BRICKLAYER'S HAMMERS  
>513



CARPENTER'S HAMMERS  
>513



HAMMERS MISCELLANEOUS  
>514



RECOILLESS HAMMERS  
>515



SAFETY HAMMERS /  
WOODEN / COPPER /  
LEAD HAMMERS  
>516



FORGING TOOLS  
>519



CHISELS  
>520



DRIFT / CENTRE /  
PIN PUNCHES / SETS  
>524



BENDING BARS / PRYBARS /  
NAIL LIFTER / CROWBARS  
>528



# SAFETY BEAT BY BEAT

For Rough Work and Precision Alike

**Large selection of hammers**

- > From the tile hammer, recoilless hammer, forging tool and engineer's hammer through to the sledge hammer
- > Top-grade industrial quality for the hardest of continuous uses
- > Available singly or in practical sets
- > Customised manufacturing and types on request

**Large selection including chisels, center punches and drift punches**

- > With optional hand guard
- > Also available in the range/set
- > Precisely hardened and annealed - long service life

**Top quality - everything from a single source**

- > The base is made up of stringently controlled quality steel and meticulously selected wood
- > Experienced and reliable specialists vouch for precision-like processing
- > Hammer head and shaft (up to 400 mm) are made in GEDORE's own production facilities in Germany
- > Stringent quality checks after each production step ensure a constantly high level

ROT BAND-PLUS system - dependability under extreme loading

- > Hammers utilise the patented ROT BAND-PLUS securing system - "no losing of heads" as a result
- > The ideal aid for site work
- > Models with extra inductively tempered edges of the faces



GEDORE hammers and GEDORE chisels - An alliance for safe working



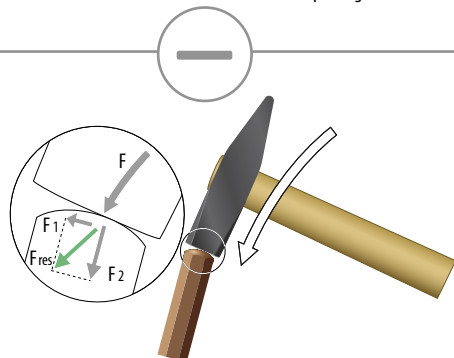



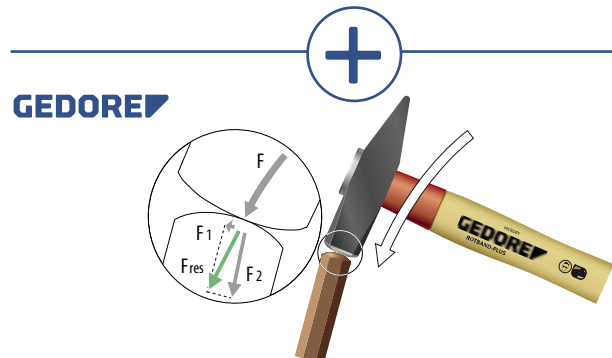















Considerable forces are liberated on hammer face and chisel head impacting on each other.



GEDORE hammers and chisels are optimally adapted to each other. Their regulation-compliant geometrical shape diverts the bulk of the forces raised towards the chisel tip.



In the case of hammers and chisels which are not ground in a regulation-compliant manner, most of the force raised is not transferred to the chisel tip and can, as a result, give rise to serious injuries.

											
		ROT BAND-PLUS	hickory	ash	tubular steel	fibreglass	plastic	rubber with steel tube	inductive	g	
	600 E	●	○	●	○	○	○	○	○	100 – 2000	○
	600 H	●	●	○	○	○	○	○	○	100 – 2000	○
	600 IH	●	●	○	○	○	○	○	●	200 – 2000	○
	4 E	○	○	●	○	○	○	○	○	50 – 2000	○
	4 H	○	●	○	○	○	○	○	○	50 – 2000	○
	4 K	○	○	○	○	○	●	○	○	200 – 1000	○
	500 F	○	○	○	○	●	○	○	○	200 – 2000	○
	500 ST	○	○	○	●	○	○	○	○	300 – 500	○
	8601	○	○	●	○	○	○	○	○	1/4 LBS – 2 LBS	○
	65 E	○	○	●	○	○	○	○	○	100 – 600	○
	620 E	●	○	●	○	○	○	○	○	1000 – 2000	○
	620 H	●	●	○	○	○	○	○	○	1000 – 2000	○
	20 E	○	○	●	○	○	○	○	○	1000 – 10000	○
	20 H	○	●	○	○	○	○	○	○	1000 – 10000	○
	20 F	○	○	○	○	●	○	○	○	1000 – 10000	○
	20 ST	○	○	○	●	○	○	○	○	1000 – 1250	○
	609 H	●	●	○	○	○	○	○	○	3000 – 8000	○
	9 E	○	○	●	○	○	○	○	○	3000 – 8000	○
	9 H	○	●	○	○	○	○	○	○	3000 – 8000	○
	9 F	○	○	○	○	●	○	○	○	3000 – 8000	○
	9 G	○	○	○	○	○	○	●	○	5000	○
	29 ST	○	○	○	●	○	○	○	○	500	○
	94 ST	○	○	○	●	○	○	○	○	600	○
	93 ST	○	○	○	●	○	○	○	○	600	○
	75 GSTM	○	○	○	all-steel	○	○	○	○	600	●
	75 STK	○	○	○	●	○	○	○	○	600	○
	75 ST	○	○	○	●	○	○	○	○	600	○
	75 STKM	○	○	○	●	○	○	○	○	600	●
	75 STM	○	○	○	●	○	○	○	○	600	●
	71 GSTM	○	○	○	all-steel	○	○	○	○		●
	677 H	●	●	○	○	○	○	○	○	300	○
	77 ST	○	○	○	●	○	○	○	○	400	○
	77 E	○	○	●	○	○	○	○	○	330	○

1000



>069

1500 CT1-350

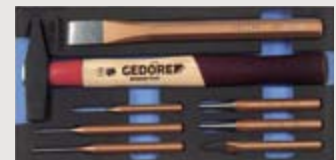

>111



# HOW CAN I TELL IF THE HAMMER IS A RELIABLE ONE?

**+ Accurate 45° edge at hammer face and pein**  
The edge - also referred to as chamfer - stops any dangerous splintering. GEDORE hammers have a clean-cut edge as conforming to regulations.

**+ Distinctive manufacturer's name on the hammer head**

**+ Assured and firm connection/fitting of hammer shaft and head**  
Take a look: are there any gaps between hammer eye and shaft? The wooden shaft must be secure and shake-free in the hammer head. The shaft/hammer head connection must be securely wedged. GEDORE only uses tapered collars which ensure optimum distribution of the clamping force in the hammer eye. The ROTBAND-PLUS system developed and patented by GEDORE turns every ordinary DIN hammer into a "safety hammer".

**+ Permanent marking**  
GEDORE stamps or forges the DIN 1041, the weight and the manufacturer's logo into the hammer head in a permanent and legible manner.

**+ The hammer head must be correctly hardened and tempered**  
No precision hardening and annealing - also referred to tempering - can be checked on without the use of aids. The hammer face and pein must have a hardness of between 50 and 58 HRC. Hardness must reach down to at least 3 mm. 30 HRC is not to be exceeded at the inserting eye for safety reasons. GEDORE manufactures on the basis of the above DIN 1193 requirements and meets them at the same time. Constant tests vouch for these figures.

**+ Is the shaft fault-free?**  
The hammer shaft is not to have any cracks, branch holes or other faults. Nor every type of wood is suitable for hammer shafts. Hickory and ash are noted as the preferred woods in DIN 68340. Only these two wood types are used by GEDORE in its own manufacturing process.

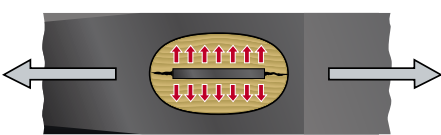

No clamping force in the direction of motion thanks to the **flat wedge**.

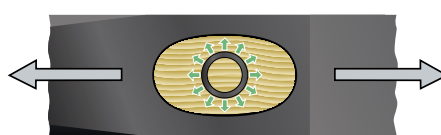

The **tapered collar** evenly distributes the clamping force across 360° i.e. also in the direction of motion. The wood fibre structure is not ruined. There is no slackening of the hammer head even after

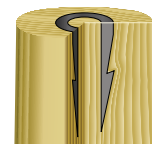

several hundred strikes. The barbed hook ensures a positive fit and stops the tapered collar from loosening. A safety "extra".



## WOODEN HANDLES



### Hickory handles

- > High quality and extremely break-proof wood. Compared with ash the physical load stability of hickory is around 3-4 times higher
- > Long-fibre structure: More safety in the event of a handle breakage - the wood is held together by the long fibres and hence uncontrolled separation of the broken handle as well as the hammer head is avoided
- > Vibration dampening
- > Long life = very good price-performance ratio



### Ash handles

- > This wood is prescribed by the DIN as the minimum wood quality
- > Inexpensive
- > Break-proof
- > Short-fibre structure: the short fibres in the wood mean that, in the event of a break, the shaft cannot be held together. The shaft breaks into two parts.

### **i** Wood is a natural product!

- > GEDORE uses only wood types and timbers that comply with DIN 68 340 (Wooden Shafts for Impact Tools)
- > Wood retains its natural properties even after processing
- > Trees regulate their moisture content by giving off moisture through their pores. This property is retained in processed wood. This means that a wooden hammer shaft loses moisture through its pores when the air humidity is low and shrinks. Too much moisture causes the wooden shaft to swell up and damages the wooden fibres.
- > DIN 68 340 defines the required moisture content of the hammer shaft at the time of joining the shaft to the head. This must be between 12 % and 14 % in relation to the dry weight. In-house manufacture under continuous quality controls guarantees compliance with the requirements of DIN 68 340

### Tip

- > Before use, always check that the hammer head is securely attached to the shaft!
- > Never store the hammer in too dry conditions!
- > Storage in well-heated rooms or near a source of heat is particularly harmful, drawing moisture out of the hammer shaft, causing the shaft section to shrink. In extreme cases, the secure fit of the hammer head on the shaft can no longer be guaranteed.

## STEEL TUBE, FIBRE GLASS OR PLASTIC HANDLES



### Tubular steel handles

- > High bending strength
- > Resistant to the influence of weather



### Fibre glass handles

- > Robust - virtually unbreakable
- > Insensitive to all weather conditions - can also be fully used in minus temperatures and is still unbreakable
- > Resistant to all common chemicals such as for example oils and greases



### Rubber grip and steel tube handle

- > Resilient
- > Unbeatable price-performance ratio since the hammer is very durable
- > Vibration dampening
- > Resistant to petrol and oil
- > Serrated gripping zones for a firm grip

### Note

- > Intensive testing of steel tube, fibre glass and plastic shafts as to a firm fit in the hammer head is required. Preference is for hammers with an additionally secured head. The head is also positively fitted to the hammer shaft by means of a spring pin.
- > Rubber handgrip feature: make sure the handgrip is firmly bonded to the shaft. Try out the turning test. A handgrip which can still be turned on the hammer shaft does not meet the DIN-prescribed figures.

### **i** Safety notes for fibre glass handles

- > Mishits with fibre glass tools can lead to the material fibre detaching.
- > To stop these fibres inflaming the skin, we would recommend safety gloves being worn during the work.

### SAFETY NOTES FOR HAMMERS

&gt; 642



# ROTBAND-PLUS HAMMERS

THE ORIGINAL - A safe join

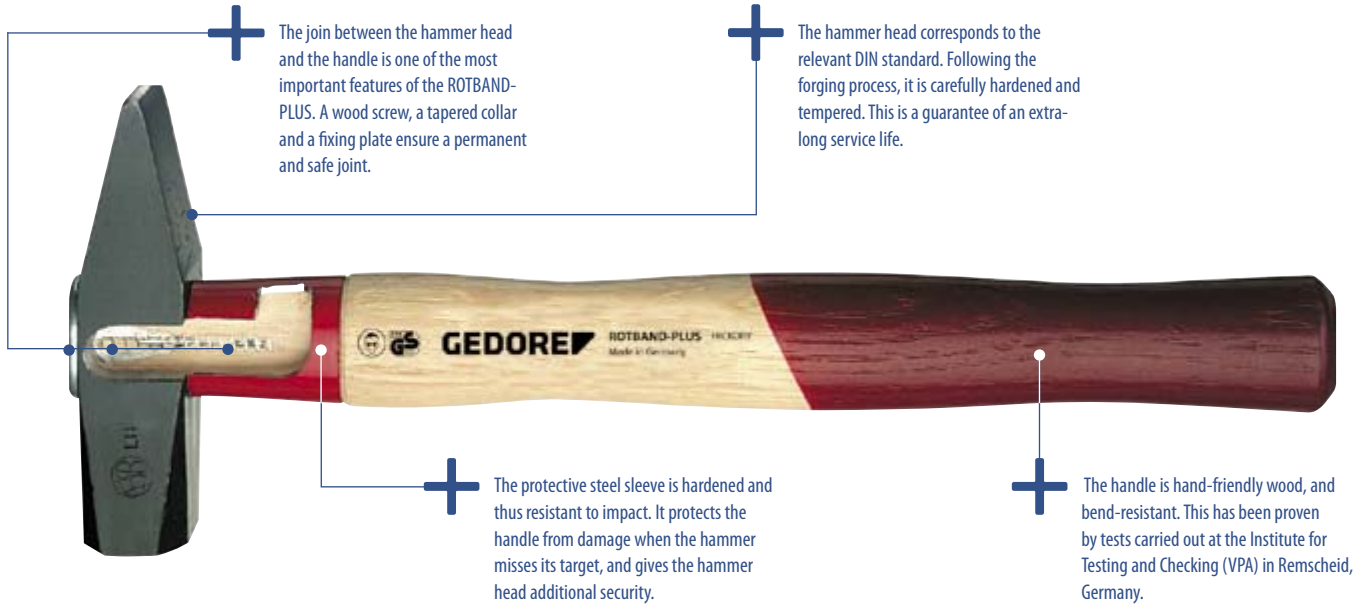

## ROTBAND-PLUS hammer

- > The hammer shaft is pressed into the hammer head.
- > The ring wedge is pressed in to secure the shaft in the eye of the hammer head.
- > The round, conical form ensures an all-round, uniform pressure.
- > Tightening the wood screw ensures a positive fit of the safety plate with the shaft.



## Safety principle

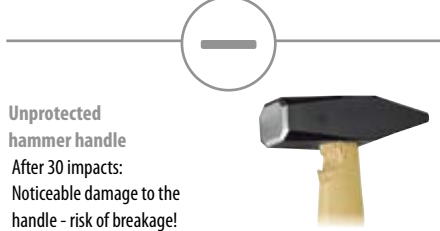

## Features

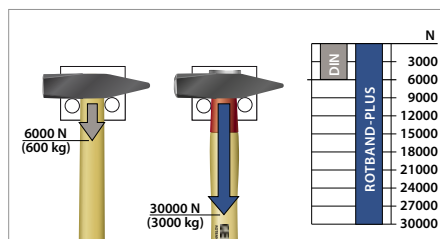

The values required by the German Standards Institute (DIN) are exceeded considerably. According to the report by the Institute for Testing and Checking (VPA) in Remscheid, with the ROTBAND-PLUS hammers more than five times the required force was attained.

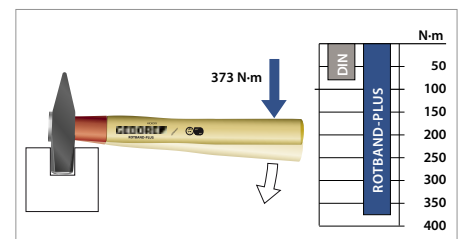

Due to the hardened ROTBAND-PLUS protective sleeve for the handle and the fixing plate, the bending strength of the ROTBAND-PLUS hammers exceeds that of standard DIN hammers by a wide margin.

## All the benefits at a single glance

- > Patented handle join ROTBAND-PLUS
- > The protective steel sleeve, the tapered collar, the fixing plate and the wood screw bond the hammer head and the handle into one unit = maximum work safety
- > Best price-performance ratio
- > The protective steel sleeve protects the handle from damage when the hammer misses its target and guarantees thus a long service life
- > With the standardised ROTBAND-PLUS handles every standardised hammer head can be turned into a ROTBAND-PLUS hammer.



## Hammers / Striking Tools

### Engineers' hammers ROTBAND-PLUS

#### 600 E + 600 H ENGINEERS' HAMMER ROTBAND-PLUS

- > Forged hammer head DIN 1041
- > With contoured ash (E 600 E) or hickory (E 600 H) handle DIN 5111, additionally shaped with a long hardened handle protective steel sleeve
- > The tapered collar, fixing plate and wood screw bond the hammer head and the handle into one unit
- > ROTBAND-PLUS handle join, high working safety, long service life, best price-performance ratio



Ash				
g	l mm	kg	Code	No.
100	260	0.188	8581610	600 E-100
200	280	0.325	8581880	600 E-200
300	300	0.502	8581960	600 E-300
400	310	0.605	8582180	600 E-400
500	320	0.727	8582260	600 E-500
600	330	0.841	8582340	600 E-600
800	350	1.135	8582420	600 E-800
1000	360	1.326	8582500	600 E-1000
1500	380	1.908	8582690	600 E-1500
2000	400	2.491	8582770	600 E-2000

Hickory				
g	l mm	kg	Code	No.
100	260	0.188	8582850	600 H-100
200	280	0.325	8582930	600 H-200
300	300	0.502	8583070	600 H-300
400	310	0.605	8583150	600 H-400
500	320	0.727	8583230	600 H-500
600	330	0.840	8583310	600 H-600
800	350	1.135	8583580	600 H-800
1000	360	1.326	8583660	600 H-1000
1500	380	1.908	8583740	600 H-1500
2000	400	2.491	8583820	600 H-2000

#### 600 IH ENGINEERS' HAMMER ROTBAND-PLUS

- > Forged hammer head DIN 1041
- > The edges of the flat side of the head are induction hardened
- > With contoured hickory handle DIN 5111, additionally shaped with a long hardened handle protective steel sleeve
- > The tapered collar, fixing plate and wood screw bond the hammer head and the handle into one unit
- > ROTBAND-PLUS handle join, high working safety, long service life, best price-performance ratio



g	l mm	kg	Code	No.
200	280	0.325	8583900	600 IH-200
300	300	0.502	8584040	600 IH-300
400	310	0.605	8584120	600 IH-400
500	320	0.727	8584200	600 IH-500
600	330	0.841	8584390	600 IH-600
800	350	1.135	8587300	600 IH-800
1000	360	1.326	8587490	600 IH-1000
1500	380	1.908	8587570	600 IH-1500
2000	400	2.491	8588970	600 IH-2000

1500 ES-350/1500 CT1-350

>103/111



6 NA

>507



## HELVING - MADE EASY



- › Hammer the handle into the hammer head until it reaches the casing
- › Drive the tapered collar into the centre of the handle
- › Fasten the safety plate with a wood screw





## E 600 E + E 600 H SPARE HANDLE ROTBAND-PLUS FOR ENGINEERS' HAMMERS

- › Ash (E 600 E) or hickory (E 600 H) DIN 5111
- › With hardened handle protective steel sleeve, tapered collar, fixing plate and wood screw
- › With this standard wooden handle, according to DIN 5111 it is possible to convert even ordinary hammer heads, as long as they are to DIN standards, to a ROTBAND-PLUS-hammer
- › Method: Hammer the handle into the hammer head until it reaches the casing. Drive the tapered collar into the centre of the handle. Fasten the safety plate with a wood screw



Ash	for  g	l- mm -l		Code	No.
<b>100</b>	260	0.076	8589000	E 600 E-100	
<b>200</b>	280	0.099	8589190	E 600 E-200	
<b>300</b>	300	0.150	8589270	E 600 E-300	
<b>400</b>	310	0.179	8589350	E 600 E-400	
<b>500</b>	320	0.185	8589430	E 600 E-500	
<b>600</b>	330	0.214	8589510	E 600 E-600	
<b>800</b>	350	0.210	8589780	E 600 E-800	
<b>1000</b>	360	0.288	8589860	E 600 E-1000	
<b>1500</b>	380	0.350	8589940	E 600 E-1500	
<b>2000</b>	400	0.377	8593700	E 600 E-2000	

Hickory	for  g	l- mm -l		Code	No.
<b>100</b>	260	0.081	8593890	E 600 H-100	
<b>200</b>	280	0.120	8595080	E 600 H-200	
<b>300</b>	300	0.134	8595160	E 600 H-300	
<b>400</b>	310	0.180	8595240	E 600 H-400	
<b>500</b>	320	0.198	8596480	E 600 H-500	
<b>600</b>	330	0.234	8596560	E 600 H-600	
<b>800</b>	350	0.296	8596640	E 600 H-800	
<b>1000</b>	360	0.315	8597880	E 600 H-1000	
<b>1500</b>	380	0.373	8597960	E 600 H-1500	
<b>2000</b>	400	0.442	8599070	E 600 H-2000	

## E 5 SPARE TAPERED COLLAR

- › For safe fastening of the wooden handles



Ø	l- mm -l		Code	No.
<b>7</b>	12.0	0.001	8593970	E 5-100
<b>8</b>	15.0	0.003	8594000	E 5-200
<b>10</b>	17.0	0.004	8594190	E 5-300
<b>11</b>	18.0	0.005	8594270	E 5-400
<b>12</b>	20.0	0.007	8594350	E 5-500

Ø	l- mm -l		Code	No.
<b>13</b>	20.0	0.008	8594860	E 5-600
<b>14</b>	21.0	0.009	8594430	E 5-800
<b>14</b>	21.0	0.010	8594940	E 5-1000
<b>15</b>	23.5	0.013	8594510	E 5-1500
<b>16</b>	23.0	0.014	8594780	E 5-2000

## Engineers' hammers

### HANDLE TYPES

> For more information on handle types see page 501



### 4 E + 4 H ENGINEERS' HAMMER

- > Forged hammer head DIN 1041
- > With ash (E 4 E) or hickory handle (E 4 H) to DIN 5111



Ash				
g	↳ mm	kg	Code	No.
50	250	0.089	8586090	4 E-50
100	260	0.158	8586170	4 E-100
200	280	0.275	8586250	4 E-200
300	300	0.440	8586330	4 E-300
400	310	0.530	8586410	4 E-400
500	320	0.625	8586680	4 E-500
600	330	0.750	8586760	4 E-600
800	350	0.930	8586840	4 E-800
1000	360	1.180	8586920	4 E-1000
1500	380	1.760	8587060	4 E-1500
2000	400	2.320	8587140	4 E-2000

Hickory				
g	↳ mm	kg	Code	No.
100	260	0.168	8590280	4 H-100
200	280	0.300	8590360	4 H-200
300	300	0.460	8590440	4 H-300
400	310	0.550	8590520	4 H-400
500	320	0.650	8590600	4 H-500
600	330	0.760	8590790	4 H-600
800	350	1.030	8590870	4 H-800
1000	360	1.210	8590950	4 H-1000
1500	380	1.859	8591090	4 H-1500
2000	400	2.370	8591170	4 H-2000

### E 4 E + E 4 H SPARE HANDLE

- > Ash (E 4 E) or hickory handle (E 4 H), acc. to DIN 5111
- > With oval fixing hole, i.e. for engineers' hammers



Ash				
for g	↳ mm	kg	Code	No.
50	250	0.033	8587650	E 4 E-50
100	260	0.045	8587730	E 4 E-100
200	280	0.085	8587810	E 4 E-200
300	300	0.099	8588030	E 4 E-300
400	310	0.100	8588110	E 4 E-400
500	320	0.160	8588380	E 4 E-500
600	330	0.140	8588460	E 4 E-600
800	350	0.165	8588540	E 4 E-800
1000	360	0.183	8588620	E 4 E-1000
1500	380	0.196	8588700	E 4 E-1500
2000	400	0.261	8588890	E 4 E-2000

Hickory				
for g	↳ mm	kg	Code	No.
100	260	0.058	8591330	E 4 H-100
200	280	0.085	8591410	E 4 H-200
300	300	0.085	8591680	E 4 H-300
400	310	0.120	8591760	E 4 H-400
500	320	0.140	8591840	E 4 H-500
600	330	0.150	8591920	E 4 H-600
800	350	0.210	8592060	E 4 H-800
1000	360	0.225	8592140	E 4 H-1000
1500	380	0.190	8592220	E 4 H-1500
2000	400	0.280	8592300	E 4 H-2000

## 4 K ENGINEERS' HAMMER

- > Forged hammer head DIN 1041
- > With Ultramid® plastic handle and safety wedge
- > Ultramid® = trade name of BASF AG, Germany



g	l mm	kg	Code	No.
200	280	0.280	8812950	4 K-200
300	300	0.430	8604170	4 K-300
500	320	0.630	8604330	4 K-500
800	350	1.020	8604680	4 K-800
1000	360	1.160	8604760	4 K-1000

## E 4 K SPARE HANDLE

- > Made from Ultramid® plastics
- > Suitable for all hammer heads acc. to DIN 1041
- > Delivery complete with tapered collar and fixing clip
- > Ultramid® = trade name of BASF AG, Germany



l mm	kg	Code	No.
280	0.070	8897170	E 4 K-200
300	0.090	8897250	E 4 K-300
320	0.120	8897330	E 4 K-500
350	0.180	8897410	E 4 K-800
360	0.192	8897680	E 4 K-1000

## 500 F ENGINEERS' HAMMER

- > Forged hammer head
- > Nearly unbreakable fibreglass handle with plastic grip
- > Additionally hardened handle protective steel sleeve, with secured head
- > Induction tempered edges of the flat side of the head available on request



g	l mm	kg	Code	No.
200	280	0.360	8598180	500 F-200
300	300	0.570	8598260	500 F-300
400	310	0.660	8598340	500 F-400
500	320	0.770	8598420	500 F-500
600	330	0.900	8598500	500 F-600
800	350	1.174	8598690	500 F-800
1000	360	1.398	8598770	500 F-1000
1500	380	1.838	8598850	500 F-1500
2000	400	2.352	8598930	500 F-2000

## 500 ST ENGINEERS' HAMMER

- > Forged hammer head
- > Steel tube handle with plastic grip
- > Very robust and durable



g	l mm	kg	Code	No.
300	270	0.575	8606620	500 ST-300
500	300	0.780	8606890	500 ST-500

248 ST

>516



## 6 NA SOFT FACE CAP

for engineers' hammers

> Polyethylene



for  g		Code	No.
<b>300</b>	0.025	8605570	6 NA-300
<b>500</b>	0.050	8605650	6 NA-500
<b>800</b>	0.060	8605730	6 NA-800
<b>1000</b>	0.053	8802990	6 NA-1000

## 8601 ENGINEER'S BALL PEIN HAMMER WITH BALL

- > With hickory handle
- > Hardened and tempered steel to EN 10083
- > Enamelled, face and ball ground



lbs	l- mm >		Code	No.
<b>1/4</b>	270	0.172	6764030	8601 1/4
<b>1/2</b>	290	0.307	6764110	8601 1/2
<b>3/4</b>	310	0.475	6764380	8601 3/4
<b>1</b>	325	0.565	6764460	8601 1
<b>1.1/8</b>	350	0.605	1429078	8601 1.1/8
<b>1.1/4</b>	350	0.772	6764540	8601 1.1/4
<b>1.1/2</b>	365	0.800	6764620	8601 1.1/2
<b>1.3/4</b>	400	0.900	1429108	8601 1.3/4
<b>2</b>	380	1.073	6764700	8601 2

## E-8601 SPARE HANDLE HICKORY

l- mm >		Code	No.
<b>270</b>	0.105	1431056	E-8601 1/4
<b>290</b>	0.120	1431102	E-8601 1/2
<b>310</b>	0.135	1431110	E-8601 3/4
<b>325</b>	0.150	1431129	E-8601 1
<b>350</b>	0.165	1431137	E-8601 1.1/8

l- mm >		Code	No.
<b>350</b>	0.180	1431145	E-8601 1.1/4
<b>365</b>	0.195	1431153	E-8601 1.1/2
<b>400</b>	0.210	1431161	E-8601 1.3/4
<b>380</b>	0.225	1431188	E-8601 2

### Joiners' hammers

## 65 E JOINERS' HAMMER

French pattern

> With contoured ash handle DIN 5111



■ mm	l- mm >	Spare handle		Code	No.
<b>20</b>	280	E 4 E-200	0.240	8684340	65 E-20
<b>22</b>	300	E 4 E-300	0.350	8684420	65 E-22

■ mm	l- mm >	Spare handle		Code	No.
<b>25</b>	310	E 4 E-400	0.450	8684500	65 E-25
<b>28</b>	320	E 4 E-500	0.590	8684690	65 E-28



## Club hammers

### 620 E + 620 H CLUB HAMMER ROT BAND-PLUS

- > Forged head DIN 6475
- > Contoured ash (E 620 E) or hickory handle (E 620 H) DIN 5135, supplementary with long hardened handle protective steel sleeve
- > The sleeve, tapered collar, fixing plate and wood screw bond the hammer head and wood handle into one unit
- > ROTBAND-PLUS handle join, high working safety, long service life, best price-performance ratio



Ash				
g	↳ mm ▷	kg	Code	No.
1000	260	1.288	8886990	620 E-1000
1250	260	1.483	8887020	620 E-1250
1500	280	1.820	8887100	620 E-1500
2000	300	2.291	8887290	620 E-2000

Hickory				
g	↳ mm ▷	kg	Code	No.
1000	260	1.317	8887370	620 H-1000
1250	260	1.493	8887450	620 H-1250
1500	280	1.820	8887530	620 H-1500
2000	300	2.240	8887610	620 H-2000

### E 620 E + E 620 H SPARE HANDLE ROTBAND-PLUS

- > Contoured ash (E 620 E) or hickory handle (E 620 H) DIN 5135
- > With hardened handle protective steel sleeve, fixing plate, tapered collar and wood screw
- > For all club hammers according to DIN 6475
- > With this handle acc. to DIN, every standard DIN club hammer head can be converted to a ROTBAND-PLUS club hammer



Ash				
for	g	↳ mm ▷	kg	Code
1000	260	0.240	8678100	E 620 E-1000
1250	260	0.230	8749650	E 620 E-1250
1500	280	0.280	8676670	E 620 E-1500
2000	300	0.310	8676750	E 620 E-2000

Hickory				
for	g	↳ mm ▷	kg	Code
1000	260	0.270	8677210	E 620 H-1000
1250	260	0.260	8749730	E 620 H-1250
1500	280	0.280	8677480	E 620 H-1500
2000	300	0.350	8677560	E 620 H-2000

### E 20 E + E 20 H SPARE HANDLE FOR CLUB HAMMERS

- > Ash (E 20 E, E 9 E) or hickory (E 20 H, E 9 H)
- > E 20 acc. to DIN 5135
- > E 9 acc. to DIN 5112



Ash				
for hammers	↳ mm ▷	kg	Code	No.
20-1000, 20-1250, 46-1000, 46-1250	260	0.151	8633940	E 20 E-1000
20-1500, 46-1500	280	0.131	8634160	E 20 E-1500
20-2000, 46-2000	300	0.178	8634240	E 20 E-2000
9-3, 10-3, 17-3, 20-3	600	0.400	8613080	E 9 E-3
9-4, 10-4, 17-4, 20-4	700	0.580	8613160	E 9 E-4
9-5, 9-6, 10-5, 10-6, 17-5, 17-6, 20-5, 20-6	800	0.730	8613240	E 9 E-5
9-8, 9-10, 17-8, 17-10, 20-8, 20-10	900	1.100	8613400	E 9 E-8

Hickory				
for hammers	↳ mm ▷	kg	Code	No.
20-1000, 20-1250	260	0.163	8636880	E 20 H-1000
20-1500	280	0.136	8637180	E 20 H-1500
20-2000	300	0.210	8637260	E 20 H-2000
9-3, 10-3, 17-3, 20-3	600	0.400	8616500	E 9 H-3
9-4, 10-4, 17-4, 20-4	700	0.630	8616690	E 9 H-4
9-5, 9-6, 10-5, 10-6, 17-5, 17-6, 20-5, 20-6	800	0.810	8616770	E 9 H-5
9-8, 9-10, 17-8, 17-10, 20-8, 20-10	900	0.960	8616930	E 9 H-8

### 20 E + 20 H CLUB HAMMER

- > Forged head DIN 6475
- > With ash (E 20 E) or hickory handle (E 20 H) DIN 5135 up to 2000 g
- > As from 3 kg with ash (E 9 E) or hickory handle (E 9 H) DIN 5112



Ash				
g	↳ mm ▷	kg	Code	No.
1000	260	1.196	8632460	20 E-1000
1250	260	1.388	8632540	20 E-1250
1500	280	1.704	8632620	20 E-1500
2000	300	2.176	8632700	20 E-2000
3000	600	3.480	8632890	20 E-3
4000	700	4.280	8632970	20 E-4
5000	800	5.750	8633000	20 E-5
6000	800	6.505	8633190	20 E-6
8000	900	9.100	8633270	20 E-8

Hickory				
g	↳ mm ▷	kg	Code	No.
1000	260	1.220	8635210	20 H-1000
1250	260	1.406	8635480	20 H-1250
1500	280	1.740	8635560	20 H-1500
2000	300	2.275	8635640	20 H-2000



## 20 F CLUB HAMMER

- > Forged head DIN 6475
- > Nearly unbreakable fibreglass handle with plastic grip and secured head

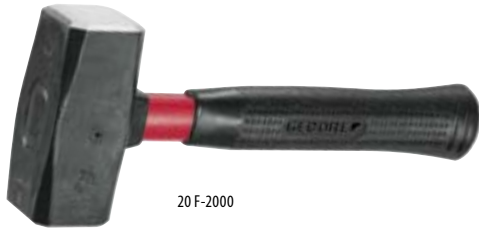

20 F-2000



20 F-8



g	↳ mm	kg	Code	No.
1000	260	1.270	8815620	20 F-1000
1250	260	1.480	8815700	20 F-1250
1500	280	1.775	8815890	20 F-1500
2000	300	2.280	8815970	20 F-2000
3000	600	3.720	8816000	20 F-3
4000	700	4.750	8866530	20 F-4
5000	800	6.430	8866610	20 F-5
6000	800	7.098	8866880	20 F-6
8000	900	9.100	8866960	20 F-8

## 20 ST CLUB HAMMER

- > Forged head
- > With steel tube handle and plastic grip
- > Very robust and durable



g	↳ mm	kg	Code	No.
1000	260	1.400	8640800	20 ST-1000
1250	260	1.570	8640990	20 ST-1250

## 21 SOFT FACE CAP

for club hammers



for club hammer g	kg	Code	No.
1000	0.330	8641960	21-1000
1250	0.375	8642180	21-1250
1500	0.310	8642260	21-1500
2000	0.290	8642340	21-2000



## Sledge hammers

**GuStaV** Gu = Rubber Sta = Steel V = Version

# THE WORLD'S SAFEST HAMMER



### HIGHEST SAFETY

- > since the hammer head is intractably fitted with the handle
- > since value **DESIGNATED 1,200 kg (12,000 N)** / value **ACTUAL 9 GuStaV: 14,650\* kg (145,500 N)**  
\*the test had to be stopped at this figure as the machine no longer had any "grappling point" due to the abraded rubber at the steel handle. The hammer head remained firmly fitted to the handle.
- > since a **hardened steel tube is mounted in the handle. The result is an unbreakable hammer when correctly used.**

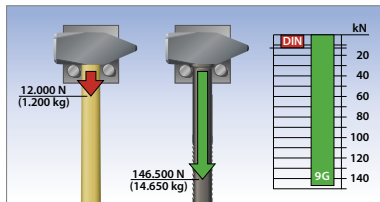

Non-taxing, fatigue-free working

### UNBEATABLE PRICE-PERFORMANCE RATIO

- > since the hammer is **very durable**
- > Hammer head and steel tube form a keyed connection. A safety extra!
- > The reinforcing bulge at the transition point from hammer handle to head ensures an even spread of forces throughout the hammer head.

### ERGONOMIC

- > since **optimum handle geometry**
- > 100 mm longer than the DIN requirement = greater impact power from the same force applied
- > Stud at the end of the handle ensures that proper gripping handle
- > The handle diameter is perfectly adjusted to the geometry of one's hand
- > since **low-on-vibration**
- > The keyed connection between hammer head and steel tube in the handle is rubber-jacketed. As a result, the rubber absorbs much of the vibration arising on impact.
- > The rubber layer vulcanised on the handle provides an extremely low modulus of elasticity and, in turn, absorbs most of the remaining vibrations.
- > Test findings: Ingenieurbüro für Ergonomie, 67824 Feilbingert: 9 GuStaV has the same positive vibration features as a comparable wooden-shaft hammer.

## 9 GUSTAV SLEDGE HAMMER

with rubber grip and steel tube handle

- > Resilient, practically unbreakable, low-on-vibration hammer
- > Forged hammer head acc. to DIN 1193
- > Head ground and clear varnished
- > Rubber handle reinforced inside with hardened steel tube
- > Hammer head and steel tube form a keyed connection. A safety extra!
- > Vibrations are absorbed by the rubber handle to the same extent as with wooden shafts
- > 900 mm handle length: 100 mm in excess of the DIN requirement - ensures more powerful strikes from the same force applied
- > Resistant to petrol and oil
- > Two serrated gripping zones. Knurled, non-sliding! Equally easy to use with either short or long arms

- > Stud-type handle and ergonomically adapted grip diameter
- > The reinforcing bulge at the transition point from hammer handle to head ensures an even spread of forces in the hammer eye
- > DBGM (= German Utility Patent)



## 609 H SLEDGE HAMMER ROTBAND-PLUS

- › Forged hammer head DIN 1042
- › Spare handles complete with steel sleeve, tapered collar, fixing plate and wood screw
- › Hickory handle DIN 5112, with additional long and hardened steel sleeve
- › ROTBAND-PLUS handle join, high working safety, long service life, best price-performance ratio



g	l mm	kg	Code	No.
3000	600	3.755	8673220	609 H-3
3000	900	3.880	8673300	609 H-3-90
4000	700	4.940	8673490	609 H-4
4000	900	5.270	8673570	609 H-4-90
5000	800	6.035	8673650	609 H-5
5000	900	6.220	8673730	609 H-5-90
6000	800	7.045	8673810	609 H-6
6000	900	7.200	8674030	609 H-6-90
8000	900	9.185	8674110	609 H-8

## E 609 H SPARE HANDLE ROTBAND-PLUS

- › Hickory handle DIN 5112
- › Steel sleeve, fixing plate, tapered collar and wood screw
- › For all hammer heads according to DIN 1042
- › With this handle, every standard DIN hammer head can be converted to a ROTBAND-PLUS-sledge hammer



l mm	kg	Code	No.	l mm	kg	Code	No.
600	0.770	8681750	E 609 H-3	900	1.082	8740860	E 609 H-5-90
900	0.990	8740510	E 609 H-3-90	800	0.900	8740350	E 609 H-6
700	0.840	8681910	E 609 H-4	900	1.100	8747950	E 609 H-6-90
900	0.840	8740780	E 609 H-4-90	900	1.390	8683610	E 609 H-8
800	1.120	8683530	E 609 H-5				

## 9E+9H SLEDGE HAMMER

- > Forged hammer head DIN 1042
- > With ash (E 9 E) or hickory handle (E 9 H) DIN 5112
- > Delivery incl. set of safety wedges



Ash				
g	l mm	kg	Code	No.
3000	600	3.330	8612000	9 E-3
3000	900	3.450	8809220	9 E-3-90
4000	700	4.365	8612190	9 E-4
5000	800	5.535	8612270	9 E-5
5000	900	5.495	8809650	9 E-5-90
6000	800	6.590	8612350	9 E-6
8000	900	8.650	8612430	9 E-8

Hickory				
g	l mm	kg	Code	No.
3000	600	3.515	8615370	9 H-3
3000	900	3.705	8812360	9 H-3-90
4000	700	4.710	8615450	9 H-4
4000	900	5.040	8812440	9 H-4-90
5000	800	5.760	8615530	9 H-5
5000	900	5.800	8812520	9 H-5-90
6000	800	6.680	8615610	9 H-6
6000	900	6.795	8812600	9 H-6-90
8000	900	8.815	8615880	9 H-8

## E9E+E9H SPARE HANDLE

- > Ash (E 9 E) or hickory (E 9 H)
- > Acc. to DIN 5112
- > Execution -90 = 90 cm handle

Ash				
for hammer	l mm	kg	Code	No.
9-3, 10-3, 17-3, 20-3	600	0.400	8613080	E 9 E-3
9-3, 9-4	900	0.660	8784210	E 9 E-3-90
9-4, 10-4, 17-4, 20-4	700	0.580	8613160	E 9 E-4
9-5, 9-6, 10-5, 10-6, 17-5, 17-6, 20-5, 20-6	800	0.730	8613240	E 9 E-5
9-5, 9-6	900	0.840	8784480	E 9 E-5-90
9-8, 9-10, 17-8, 17-10, 20-8, 20-10	900	1.100	8613400	E 9 E-8

Hickory				
for hammer	l mm	kg	Code	No.
9-3, 10-3, 17-3, 20-3	600	0.400	8616500	E 9 H-3
9-3, 9-4	900	0.790	8786180	E 9 H-3-90
9-4, 10-4, 17-4, 20-4	700	0.630	8616690	E 9 H-4
9-5, 9-6, 10-5, 10-6, 17-5, 17-6, 20-5, 20-6	800	0.810	8616770	E 9 H-5
9-5, 9-6	900	0.700	8786260	E 9 H-5-90
9-8, 9-10, 17-8, 17-10, 20-8, 20-10	900	0.960	8616930	E 9 H-8

## 9F SLEDGE HAMMER

- > Forged hammer head DIN 1042
- > With practically unbreakable fibreglass handle, with secured head



g	l mm	kg	Code	No.
3000	600	3.665	8614130	9 F-3
3000	900	3.955	8820380	9 F-3-90
4000	700	4.930	8614210	9 F-4
4000	900	5.050	8820890	9 F-4-90
5000	800	6.370	8614480	9 F-5
5000	900	6.420	8820970	9 F-5-90
6000	800	7.165	8614560	9 F-6
8000	900	9.280	8614640	9 F-8

## Bricklayer's hammers

### 94 ST BRICKLAYER'S HAMMER

Berlin pattern

- > With steel tube handle and plastic grip
- > Very robust and durable



g	l - mm - l	kg	Code	No.
600	270	0.891	8697240	94 ST

### 93 ST BUILDER'S HATCHET

- > With steel tube handle and plastic grip
- > Very robust and durable



g	l - mm - l	kg	Code	No.
600	300	0.909	8696510	93 ST

## Carpenter's hammers

### 75 GSTM CARPENTER'S HAMMER

- > Head and handle forged in one piece, nearly unbreakable
- > Ergonomic, air-cushioned 2-component handle
- > Optimum impact force - a result of its perfect balance
- > Fatigue-free working due to the new anti-vibration system
- > With straight-through shaft right to the end of the handle
- > With magnetic nail holder



l - mm - l	kg	Code	No.
340	0.873	1576143	75 GSTM

### 75 ST + 75 STM CARPENTER'S HAMMER

- > With steel tube handle and plastic grip
- > 75 ST without magnet
- > 75 STM with magnet
- > Very robust and durable



Execution	g	l - mm - l	Handle length	kg	Code	No.
without magnet	600	317	300	0.760	8688920	75 ST
with magnet	600	317	300	0.835	8689220	75 STM

### 75 STKM CARPENTER'S HAMMER WITH MAGNET

- > With steel tube handle, plastic grip and secured head
- > Very robust and durable



Execution	g	l - mm - l	Handle length	kg	Code	No.
with magnet	600	317	300	0.847	8813090	75 STKM

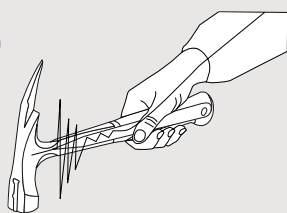

> The anti-vibration system of the 75 GSTM and 71 GSTM allows safe, powerful hammer blows

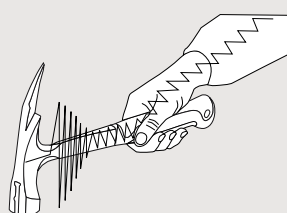

> With conventional all-steel hammers, jarring vibrations are transmitted through to the user's arm on every impact

WT 1056 7

>566



## Hammers miscellaneous

### 18 E PAVING HAMMER SQUARE

- > With welded plate and large vulcanised rubber block
- > With ash handle
- > Spare handle E 18 E

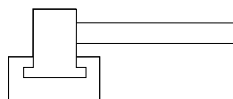

g	mm	kg	Code	No.
360	E 18 E	2.525	8883700	18 E

### E 18 E SPARE HANDLE

- > Acc. to DIN 5111
- > From ash
- > With oval fixing hole



mm	kg	Code	No.
360	0.345	8883890	E 18 E

### 72 H GLAZIERS HAMMER

polished

- > With hickory handle, steel sleeve and safety screw for a durable safe connection of handle and hammer head
- > Spare handle E 72 H



g	mm	kg	Code	No.
100	300	0.212	1541935	72 H-100
	300	0.040	1541730	E 72 H-100

## Scaling hammers

### 677 H SCALING HAMMER ROTBAND-PLUS

- > Forged hammer head
- > Contoured hickory handle DIN 5111 with additional long, hardened steel sleeve
- > The sleeve, tapered collar, fixing plate and wood screw bond the hammer head and wood handle into one unit
- > ROTBAND-PLUS handle join, high working safety, long service life, best price-performance ratio
- > Spare handle E 677 H



g	mm	kg	Code	No.
300	300	0.450	8671950	677 H
	300	0.150	1822357	E 677 H-300

### 77 E SCALING HAMMER

- > With ash handle DIN 5111
- > Spare handle E 4 E



g	mm	kg	Code	No.
330	300	0.390	8690900	77 E-300
	300	0.099	8588030	E 4 E-300



## 77 ST SCALING HAMMER

- > Acc. to DIN 5133
- > With steel tube handle



g		Code	No.
400	0.505	8691390	77 ST-400

## 41 E SCALING HAMMER

- > With ash handle DIN 5111
- > Spare handle E 4 E



g	l mm		Code	No.
500	320	0.640	8665390	41 E-500
	320	0.160	8588380	E 4 E-500

### Recoilless hammers

#### YOUR ADVANTAGE:

- > Due to the special filling insert in the hammer head a considerably higher impact is made compared to standard engineers' and recoilless hammers
- > Universal use for service and assembly work, with all the advantages of a recoilless hammer with higher impact
- > "Dead blows" with no recoil reduce stress on muscles, nerves and wrists
- > Lower cost due to universal use as an engineer's and recoilless hammer
- > Recoilless hammers protect sensitive surfaces
- > Each blow is more effective than standard safety hammers
- > Available with hickory, tubular steel or fibreglass handles
- > Exchangeable inserts, resistant to breakage or wear, made of modified polyamide

#### FUNCTION



- > The hollow hammer head is filled with steel shot. Small steel balls with a high carbon content.
- > Workpiece "adhesion" and a "fully-felt" strike come from the practically 100% pulse transfer onto the workpiece.
- > The impact (colloquial term for pulse) results principally from the kinetic energy of the fine-grained steel shot.
- > The hammer head mass is slight compared to steel shot.
- > That is why the counter pulse triggered by the hammer head is not felt.
- > Bouncing blows are avoided.
- > Goes easy on one's joints and tendons.

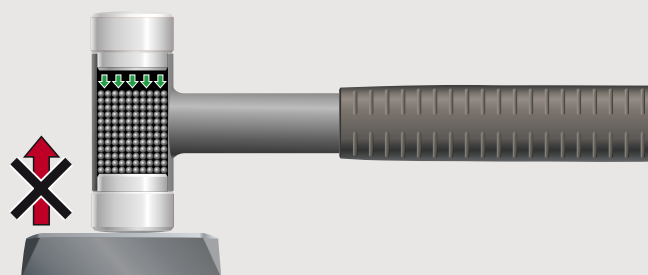
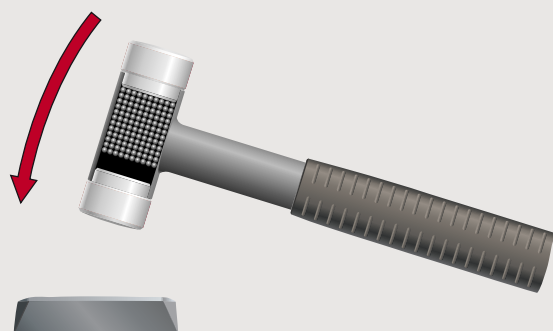

## 248 H RECOILLESS HAMMER

- > With hickory handle
- > Splinter-proof, shatter-proof and wear-resistant polyamide heads, 75 Shore D, tested to -20° C
- > Powder-coated with silver hammer-effect enamel

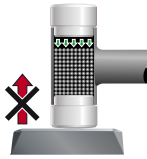

Ø mm	l mm	kg	Code	No.
25	305	0.300	8728220	248 H-25
30	330	0.470	8868230	248 H-30
35	335	0.590	8868310	248 H-35
40	360	0.730	8868580	248 H-40
45	365	0.870	8868660	248 H-45
50	370	1.020	8868740	248 H-50
60	370	1.650	8868820	248 H-60
70	370	2.330	8728300	248 H-70
80	880	4.270	8728490	248 H-80
100	1000	6.935	8728570	248 H-100

## E 248 H SPARE HANDLE HICKORY

l mm	kg	Code	No.
280	0.062	8739690	E 248 H-25
300	0.120	8739770	E 248 H-30-35
320	0.140	8739850	E 248 H-40-45
320	0.180	8739930	E 248 H-50
310	0.210	8740000	E 248 H-60-70
800	0.680	8740190	E 248 H-80
900	1.100	8740270	E 248 H-100

## E 248 POLYAMIDE SPARE HEAD (PIECE)

- > Splinter-proof, shatter-proof and wear-resistant polyamide, 75 Shore D, tested to -20° C

Ø mm	kg	Code	No.
20	0.010	8747790	E 248-20
25	0.010	8747870	E 248-25
30	0.015	8830260	E 248-30
35	0.021	8830340	E 248-35
40	0.031	8830420	E 248-40
45	0.040	8829920	E 248-45
50	0.050	8830500	E 248-50
60	0.090	8830690	E 248-60
70	0.130	8748410	E 248-70
80	0.190	8748680	E 248-80
100	0.350	8748760	E 248-100

## 248 F RECOILLESS HAMMER

- > Nearly unbreakable fibreglass handle with handy plastic grip and secured head
- > Splinter-proof, shatter-proof and wear-resistant polyamide heads, 75 Shore D, tested to -20° C
- > Powder-coated with silver hammer-effect enamel

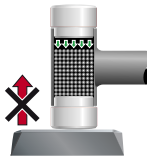

Ø mm	l mm	kg	Code	No.
25	290	0.400	8724310	248 F-25
30	305	0.550	8867690	248 F-30
35	310	0.730	8867770	248 F-35
40	315	0.780	8867850	248 F-40
45	320	0.940	8867930	248 F-45
50	325	1.120	8868070	248 F-50
60	335	1.680	8868150	248 F-60

## 248 ST RECOILLESS HAMMER

- > With very robust and durable steel tube handle
- > Splinter-proof, shatter-proof and wear-resistant polyamide heads, 75 Shore D, tested to -20° C
- > Powder-coated with silver hammer-effect enamel

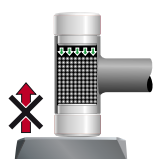

Ø mm	l mm	kg	Code	No.
25	270	0.440	8724070	248 ST-25
30	290	0.600	8828950	248 ST-30
35	295	0.700	8829090	248 ST-35
40	300	0.800	8829170	248 ST-40
45	305	0.950	8829410	248 ST-45
50	310	1.005	8829250	248 ST-50
60	335	1.800	8829330	248 ST-60
70	335	2.430	8724150	248 ST-70

# KOMBI-PLUS R

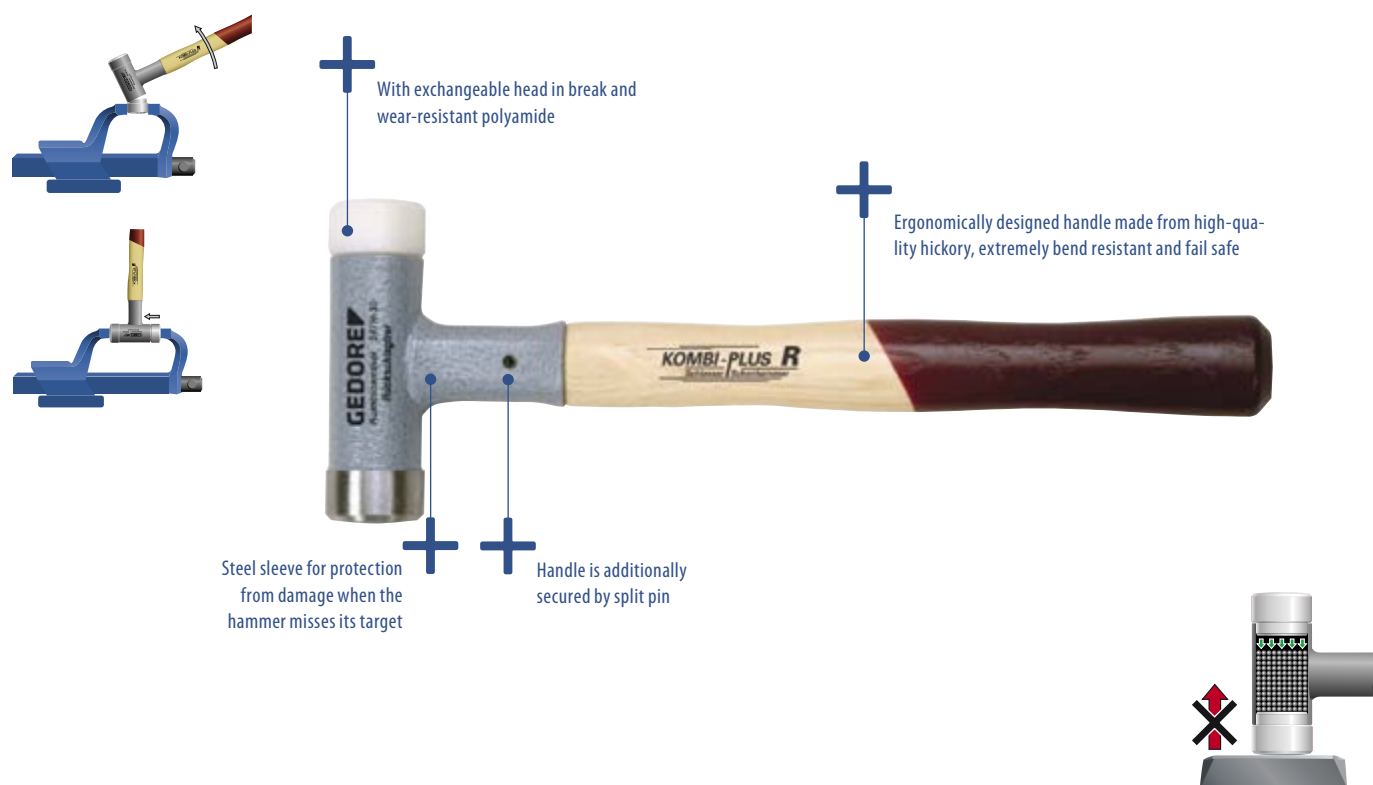

## 247 H COMBINATION HAMMER KOMBI-PLUS R

- > Reduced expense due to versatile use as an engineer's and recoilless hammer
- > Universal use for service and assembly work
- > With all advantages of a recoilless hammer with higher impact
- > Less energy necessary, easier working
- > With exchangeable splinter-proof, shatter-proof and wear-resistant polyamide head (E 247), 75 Shore D, tested to -20 °C
- > With hickory handle (E 247 H)
- > DBGM (German utility patent)

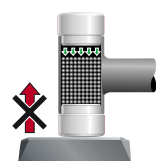

Ø mm	l mm	kg	Code	No.
30	305	0.460	1603299	247 H-30
35	310	0.690	1603396	247 H-35
40	330	0.840	1687883	247 H-40

## E 247 H SPARE HANDLE HICKORY KOMBI-PLUS R

- > Ergonomically designed handle made from high-quality hickory
- > Extremely bend resistant and fail safe

l mm	kg	Code	No.
270	0.100	1605313	E 247 H-30
270	0.120	1630709	E 247 H-35
290	0.126	1688014	E 247 H-40

## E 247 POLYAMIDE SPARE HEAD (PIECE) KOMBI-PLUS R

- > Splinter-proof, shatter-proof and wear-resistant polyamide, 75 Shore D, tested to -20 °C

Ø mm	kg	Code	No.
30	0.021	1605305	E 247-30
35	0.034	1605380	E 247-35
40	0.040	1688022	E 247-40

## Safety hammers

### 224 E PLASTIC HAMMER

- > With exchangeable heads made from yellow shatter-proof cellulose acetate
- > With ash handle
- > 65 Shore D



Ø mm	l mm	Spare handle	kg	Code	No.
22	250	E 224 E-22	0.157	8821270	224 E-22
27	270	E 224 E-27	0.242	8821350	224 E-27
32	280	E 224 E-32	0.365	8821430	224 E-32
35	290	E 224 E-35	0.445	8821510	224 E-35
40	320	E 224 E-40	0.600	8821780	224 E-40
50	340	E 224 E-50	0.913	8821860	224 E-50
60	380	E 224 E-60	1.392	8821940	224 E-60

### 225 E NYLON HAMMER

- > With exchangeable heads made from impact-resistant nylon
- > With ash handle
- > 60 Shore D



Ø mm	l mm	kg	Code	No.
22	250	0.160	8805310	225 E-22
27	270	0.250	8805580	225 E-27
32	280	0.350	8805660	225 E-32
35	290	0.420	8805740	225 E-35
40	320	0.580	8805820	225 E-40
50	340	0.900	8805900	225 E-50
60	380	1.340	8806040	225 E-60

### E 224 PLASTIC SPARE HEAD

- > From shatter-proof cellulose acetate
- > 65 Shore D

Ø mm	kg	Code	No.
22	0.005	8822590	E 224-22
27	0.015	8822670	E 224-27
32	0.025	8822750	E 224-32
35	0.030	8822830	E 224-35
40	0.040	8822910	E 224-40
50	0.070	8823050	E 224-50
60	0.110	8823130	E 224-60

### E 224 E SPARE HANDLE ASH

for no. 224 E + 225 E

l mm	kg	Code	No.
250	0.060	8823210	E 224 E-22
270	0.060	8823480	E 224 E-27
280	0.080	8823560	E 224 E-32
290	0.060	8823640	E 224 E-35
320	0.100	8823720	E 224 E-40
340	0.100	8824290	E 224 E-50
380	0.115	8824370	E 224 E-60

### E 225 NYLON SPARE HEAD

- > From impact-resistant nylon
- > 60 Shore D

Ø mm	kg	Code	No.
22	0.005	8814220	E 225-22
27	0.010	8814300	E 225-27
32	0.015	8814490	E 225-32
35	0.025	8814570	E 225-35
40	0.030	8814650	E 225-40
50	0.055	8814730	E 225-50
60	0.085	8814810	E 225-60

## 226 E RUBBER MALLET

hard

- > DIN 5128-90, 90 Shore A
- > With two flat surfaces
- > **2 A** with one curved and one flat surface
- > With ash handle



Ø mm	h mm	l mm	kg	Code	No.
40	80	260	0.210	8825500	226 E-0
55	90	320	0.370	8825690	226 E-1
65	115	340	0.630	8825770	226 E-2
65	115	340	0.578	8825850	226 E-2 A
75	130	380	0.990	8825930	226 E-3
90	140	380	1.150	8826070	226 E-4

## 227 E RUBBER MALLET

soft

- > DIN 5128-60, 60 Shore A
- > With two flat surfaces
- > With ash handle



Ø mm	h mm	l mm	kg	Code	No.
55	90	320	0.320	8826740	227 E-1
65	115	340	0.540	8826820	227 E-2
75	130	380	0.770	8827040	227 E-3
90	140	380	1.050	8827120	227 E-4

## E 226 E SPARE HANDLE ASH

for no. 226 E + 227 E

l mm	kg	Code	No.
260	0.043	8826230	E 226 E-0
320	0.045	8826310	E 226 E-1
340	0.100	8826580	E 226 E-2

l mm	kg	Code	No.
380	0.130	8827200	E 226 E-3
380	0.170	8827390	E 226 E-4

## Wooden / Copper / Lead hammers

## 228 WOODEN MALLET

- > Made from white beech wood
- > Acc. to DIN 7462 A



Ø mm	l mm	kg	Code	No.
70	340	0.470	8828280	228-70

## 229 WOODEN MALLET

- > Head made from white beech wood with pressed steel holder
- > With oval ash handle
- > Acc. to DIN 7462 B



Ø mm	l mm	kg	Code	No.
60	310	0.340	8601230	229-60
70	320	0.610	8601310	229-70



## 21 F LIGHT METAL HAMMER

- > Cylindrical pattern
- > Nearly unbreakable fibreglass handle with plastic grip



Ø mm	g	l mm	kg	Code	No.
40	250	300	0.440	2015110	21 F-250
45	500	320	0.710	2015129	21 F-500
60	1000	360	1.250	2015137	21 F-1000
70	1500	400	1.790	2015145	21 F-1500

## 223 H LEAD HAMMER

- > Barrel shape, with end-to-end split pin
- > With hickory handle DIN 5111
- > Spare handle E 4 H



g	l mm	kg	Code	No.
1000	310	1.160	8820460	223 H-1000
1500	350	1.840	8820540	223 H-1500

l mm	kg	Code	No.
310	0.120	8591760	E 4 H-400
350	0.210	8592060	E 4 H-800

## 22 H COPPER HAMMER

- > Club shape
- > Forged hammer head
- > With hickory handle DIN 5111
- > Spare handle E 4 H



g	l mm	kg	Code	No.
250	280	0.316	1583999	22 H-250
500	310	0.715	1584006	22 H-500
750	330	1.050	8867260	22 H-750
1000	350	1.333	8867340	22 H-1000
1500	360	1.933	8867420	22 H-1500
2000	400	2.341	8867500	22 H-2000

l mm	kg	Code	No.
280	0.085	8591410	E 4 H-200
310	0.120	8591760	E 4 H-400
330	0.150	8591920	E 4 H-600
350	0.210	8592060	E 4 H-800
360	0.225	8592140	E 4 H-1000
400	0.280	8592300	E 4 H-2000

## 622 H COPPER HAMMER ROT BAND-PLUS

- > Club shape
- > With hickory handle DIN 5111, with additional long hardened handle protective steel sleeve
- > Spare handle E 600 H / E 609 H
- > The sleeve, tapered collar, fixing plate and wood screw bond the hammer head and wood handle into one unit
- > ROTBAND-PLUS handle join, high working safety, long service life, best price-performance ratio
- > Also available in a heavy 5 kg version



g	l mm	kg	Code	No.
750	350	1.120	8672410	622 H-750
1000	360	1.468	8672680	622 H-1000
1500	380	2.075	8672760	622 H-1500
2000	400	2.300	8672840	622 H-2000
5000	800	6.150	1985094	622 H-5

l mm	kg	Code	No.
330	0.234	8596560	E 600 H-600
350	0.296	8596640	E 600 H-800
360	0.315	8597880	E 600 H-1000
400	0.442	8599070	E 600 H-2000
800	1.120	8683530	E 609 H-5

## Forging Tools

### 37 E COLD CHISEL HAMMER

- > For separating cold forgings
- > With ash handle
- > Spare handle E 37 E



↔ mm ↔	g	kg	Code	No.
600	1500	1.810	8663850	37 E-1500
600		0.270	8663930	E 37 E-1500

### 38 E HOT CHISEL HAMMER

- > For separating warm forge pieces
- > With ash handle
- > Spare handle E 37 E



↔ mm ↔	g	kg	Code	No.
600	1500	1.760	8664310	38 E-1500
600		0.270	8663930	E 37 E-1500

### 56 E PUNCH HAMMER

- > With ash handle
- > Spare handle E 37 E
- > Can be supplied with rebound-dampened tubular steel handle



∅ mm	↔ mm ↔	g	kg	Code	No.
10	600	850	1.010	8679500	56 E-10
15	600	1000	1.480	8679690	56 E-15
20	600	1470	1.770	8679770	56 E-20

∅ mm	↔ mm ↔	g	kg	Code	No.
	600		0.270	8663930	E 37 E-1500

## BLACKSMITH'S TONGS





## Striking Tools

### WHAT IS SO SPECIAL ABOUT GEDORE STRIKING TOOLS?



- > The striking thing about GEDORE striking tools is the 45CrMoV7 material used - one which has a 30 % higher strength (under the same hardness) than the usual DIN 59CrV4 material. This very much distinguishes GEDORE striking tools from the products of its competitors. This is very true indeed for nail lifters.
- > The material (45CrMoV7) used by GEDORE is a pure air-hardening steel which hardens at a temperature of about 850 °C in still air. This material features both a high level of stability and enormous toughness. Tools cannot break even under the hardest of working conditions.
- > GEDORE pin punches always have a minus tolerance. This rules out any jamming in the drill hole.
- > All tools are fully hardened over their entire length. Tools cannot break even under the hardest of working conditions.
- > The hammer heads of our tools are electro-inductively and hence homogeneously tempered. In this way, maximum stability is achieved and splintering avoided.
- > The head shape of the GEDORE striking tools is optimally adapted to the radius of the hammer face.

## Chisels

### 108 UNI PROTECTIVE HAND GUARD

- > Made from PVC
- > Improved protective plate offers highest safety for the hand against impacts
- > Ergonomic design
- > Avoids injuries of the hand
- > No rolling away (elliptical-shaped)
- > Jarring blows do not move into the hand
- > No fatigue of the hand - optimum hold
- > All chisels from 250 mm length can be supplied with universal protective hand guard (HS)
- > DBGM (German utility patent)

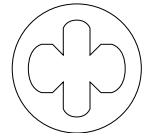

oval	octagonal	kg	Code	No.
<b>20 x 12</b>	14	0.182	8658500	108 UNI
<b>23 x 13</b>	16			
<b>26 x 13</b>	18			
<b>26 x 7</b>	20			

### 97 FLAT COLD CHISEL

octagonal

- > Chrome-molybdenum-vanadium air hardening steel 45CrMoV7
- > Carefully hardened and tempered along the full length
- > Striking heads inductively tempered
- > Working edge polished and clear varnished

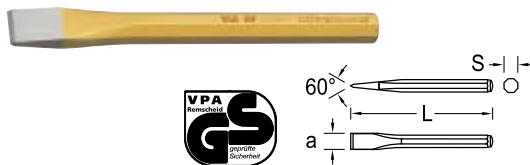

L	a	s	kg	Code	No.
<b>125</b>	12	10	0.069	8703820	97-125
<b>150</b>	16	12	0.130	8703900	97-150
<b>175</b>	20	16	0.270	8704040	97-175
<b>200</b>	22	18	0.380	8704120	97-200
<b>250</b>	24	20	0.406	2004666	97-250

### 95 FLAT COLD CHISEL

flat oval

- > Acc. to DIN 6453
- > Chrome-molybdenum-vanadium air hardening steel 45CrMoV7
- > Carefully hardened and tempered along the full length
- > Striking heads inductively tempered
- > Working edge polished and clear varnished
- \* not standardised



L	a	b	h	kg	Code	No.
<b>100</b>	15	14	9	0.075	8698560	95-100
<b>125</b>	15	14	9	0.100	8698640	95-125
<b>150</b>	18	17	11	0.190	8698720	95-150
<b>175</b>	21	20	12	0.280	8698800	95-175
<b>200</b>	24	23	13	0.390	8698990	95-200
<b>225</b>	*	24	13	0.460	8699610	95-225
<b>250</b>		25	13	0.500	8699020	95-253
<b>250</b>	*	28	13	0.570	8699100	95-250
<b>300</b>		26	13	0.604	8699290	95-303
<b>300</b>	*	30	13	0.710	8699370	95-300
<b>400</b>	*	30	13	0.950	8699450	95-400
<b>500</b>	*	30	26	1.160	8699530	95-500

1500 ES-350

&gt;103



## 104 SPLITTING CHISEL

flat

- > Chrome-molybdenum-vanadium air hardening steel 45CrMoV7
- > Forged
- > Carefully hardened and tempered along the full length
- > Striking heads inductively tempered
- > Working edge polished and clear varnished
- > 104 HS with protective hand guard 108 UNI
- > 104 P with plastic grip



104

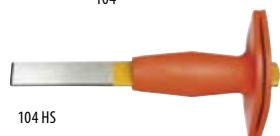

104 HS



104 P

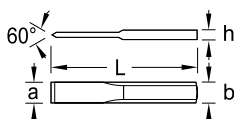

L	a	b	h	kg	Code	No.
240	26	26	7	0.260	8723850	104
240	26	26	7	0.290	8724230	104 P
240	26	26	7	0.400	8723930	104 HS

## 2104 SPLITTING CHISEL

extra flat

- > Chrome-vanadium steel
- > Carefully hardened and tempered along the full length
- > Striking heads inductively tempered
- > Working edges polished and clear varnished

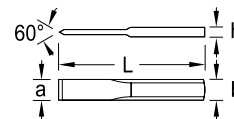

L	a	b	h	kg	Code	No.
240	26	26	4	0.198	8911420	2104

## 103 BRICK CUTTING CHISEL

flat oval

- > With broad blade to chisel joints into walls, plaster, tiles, etc.
- > Chrome-molybdenum-vanadium air hardening steel 45CrMoV7
- > Carefully hardened and tempered along the full length
- > Striking heads inductively tempered

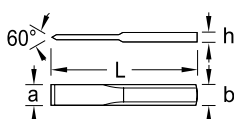

L	a	b	h	kg	Code	No.
250	50	26	13	0.532	8723420	103-50
250	60	26	13	0.557	8723500	103-60
250	80	26	13	0.558	8723690	103-80

## 109 BRICKLAYER'S CHISEL

flat oval

- > Acc. to DIN 7254 Form A
- > Chrome-molybdenum-vanadium air hardening steel 45CrMoV7
- > Carefully hardened and tempered along the full length
- > Striking heads inductively tempered
- > Working edge polished and clear varnished

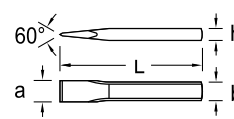

L	a	b	h	kg	Code	No.
200	26	20	12	0.320	8728650	109-200
250	26	20	12	0.400	8728730	109-250
300	29	23	13	0.610	8728810	109-300
350	29	23	13	0.710	8729030	109-350
400	29	23	13	0.830	8729110	109-400

# 110 BRICKLAYER'S CHISEL

octagonal

- > Acc. to DIN 7254 Form B
- > Chrome-molybdenum-vanadium air hardening steel 45CrMoV7
- > Carefully hardened and tempered along the full length
- > Striking heads inductively tempered
- > Working edge polished and clear varnished

\* not standardised

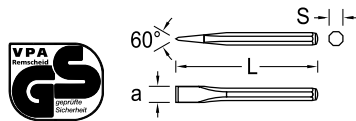

L	a	s		Code	No.
200	23	16	0.300	8731280	110-216
250	23	16	0.390	8731440	110-256
300	*	23	0.460	8731600	110-316
300	26	18	0.600	8731790	110-318
350	26	18	0.700	8731870	110-358
400	*	26	0.810	8731950	110-418
400	30	20	0.990	8732090	110-420

# 111 POINT CHISEL

octagonal

- > Acc. to DIN 7256
- > Chrome-molybdenum-vanadium air hardening steel 45CrMoV7
- > Carefully hardened and tempered along the full length
- > Striking heads inductively tempered
- > Working edge polished and clear varnished, free of burrs

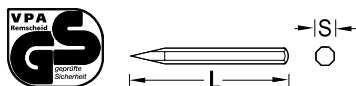

L	s		Code	No.
200	16	0.290	8741080	111-216
250	16	0.370	8741240	111-256
300	16	0.444	8741400	111-316
300	18	0.576	8741590	111-318
350	18	0.670	8741670	111-358
400	18	0.775	8741750	111-418

# 112 A ELECTRICIANS' CHISEL

octagonal

- > Chrome-molybdenum-vanadium air hardening steel 45CrMoV7
- > Carefully hardened and tempered along the full length
- > Striking heads inductively tempered
- > Working edge polished and clear varnished

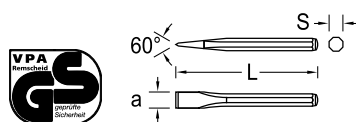

L	a	s		Code	No.
250	12	10	0.152	8745900	112 A-250
300	15	12	0.264	8746040	112 A-300

# 110 HS BRICKLAYER'S CHISEL

octagonal

- > Acc. to DIN 7254 Form B
- > With protective hand guard 108 UNI
- > Chrome-molybdenum-vanadium air hardening steel 45CrMoV7
- > Carefully hardened and tempered along the full length
- > Striking heads inductively tempered
- > Working edge polished and clear varnished

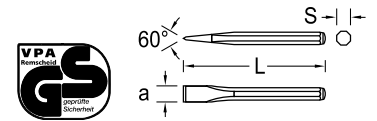

L	a	s		Code	No.
250	23	16	0.510	8732680	110 HS-256
300	26	18	0.720	8733140	110 HS-318

# 112 ELECTRICIANS' CHISEL

square

- > Chrome-vanadium steel
- > Carefully hardened and tempered along the full length
- > Striking heads inductively tempered
- > Working edge polished and clear varnished

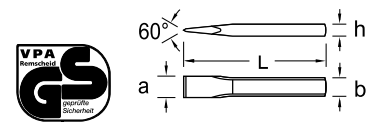

L	a	b		Code	No.
200	6	6	0.054	8744500	112-2006
200	8	6	0.054	8744690	112-2008
200	10	7	0.073	8744770	112-2100
250	8	6	0.068	8744930	112-2508
250	10	7	0.091	8745070	112-2510
250	12	8	0.119	8745150	112-2512
300	15	10	0.227	8745310	112-3000

# 112 S ELECTRICIANS' SPLITTING CHISEL

- > Chrome-molybdenum-vanadium air hardening steel 45CrMoV7
- > Carefully hardened and tempered along the full length
- > Striking heads inductively tempered
- > Working edge polished and clear varnished



L	a	b		Code	No.
200	26.8	46	0.228	8746550	112 S

## 96 CROSS-CUT CHISEL

flat oval

- > Acc. to DIN 6451
- > Chrome-molybdenum-vanadium air hardening steel 45CrMoV7
- > Carefully hardened and tempered along the full length
- > Striking heads inductively tempered
- > Working edge polished and clear varnished





L	a	b	h		Code	No.
125	5	14	9	0.098	8702180	96-125
150	6	17	11	0.170	8702260	96-150
175	7	17	11	0.210	8702340	96-175
200	8	20	12	0.290	8702420	96-200
250	9	23	13	0.530	8702500	96-250

## 98 CROSS-CUT CHISEL

octagonal

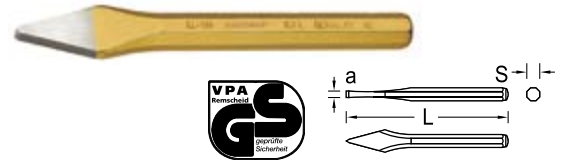
- > Chrome-molybdenum-vanadium air hardening steel 45CrMoV7
- > Carefully hardened and tempered along the full length
- > Striking heads inductively tempered
- > Working edge polished and clear varnished





L	a	s		Code	No.
125	5	10	0.066	8704630	98-125

## 202 TILE CHISEL

flat

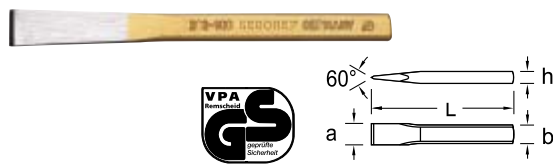
- > Chrome-vanadium steel 59CrV4
- > Carefully hardened and tempered along the full length
- > Striking heads inductively tempered
- > Working edge polished and clear varnished



L	a	b		Code	No.
100	10	7	0.033	8879430	202-100

## 203 TILE CHISEL

square, pointed

- > Chrome-vanadium steel 59CrV4
- > Driving point polished and clear varnished





L	s		Code	No.
100	7	0.032	8880280	203-100

## 128 PARING CHISEL

octagonal

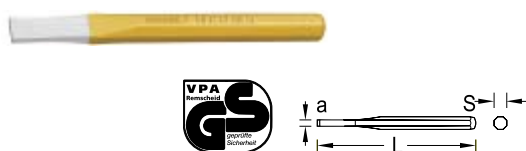
- > Chrome-molybdenum-vanadium air hardening steel 45CrMoV7
- > Carefully hardened and tempered along the full length
- > Striking head inductively tempered
- > Working edge polished and clear varnished



L	a	s		Code	No.
120	2	10	0.070	8775650	128-2

## 129 GROOVING CHISEL

octagonal

- > Acc. to DIN 6455
- > Chrome-molybdenum-vanadium air hardening steel 45CrMoV7
- > Carefully hardened and tempered along the full length
- > Striking head inductively tempered
- > Working edge polished and clear varnished



L	a	s		Code	No.
150	3	10	0.070	8776460	129-3

## Drift / Centre / Pin Punches

### 99 DRIFT PUNCH

octagonal

- > Acc. to DIN 6458
- > Chrome-molybdenum-vanadium air hardening steel 45CrMoV7
- > Carefully hardened and tempered along the full length
- > Striking heads inductively tempered
- > Working edge polished and clear varnished
- > Special types or sizes on request
- \* not standardised

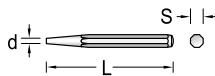

d	L	s	kg	Code	No.
1	120	10	0.060	8708700	99 10-1
2	120	10	0.061	8708970	99 10-2
3	120	10	0.063	8709190	99 10-3
4	120	10	0.065	8709350	99 10-4
5	120	10	0.063	8709510	99 10-5
3	120	12	0.088	8710950	99 12-3
4	120	12	0.086	8711170	99 12-4
5	120	12	0.091	8711330	99 12-5
6	120	12	0.094	8711410	99 12-6
7	120	12	0.096	8711680	99 12-7
8	120	12	0.099	8711760	99 12-8
10	*	120	0.103	8711920	99 12-10

### 100 CENTRE PUNCH

octagonal

- > Acc. to DIN 7250
- > Chrome-molybdenum-vanadium air hardening steel 45CrMoV7
- > Carefully hardened and tempered along the full length
- > Striking heads inductively tempered
- > Working edge polished and clear varnished
- \* not standardised

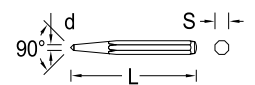

d	L	s	kg	Code	No.
4	120	10	0.063	8721050	100-10
5	120	12	0.091	8721130	100-12
5	150	12	0.119	8721210	100-15
8	*	150	0.216	8721480	100-16

922

>565



1500 CT1-350

>111



### 100 A CENTRE PUNCH

octagonal, with carbide tip

- > Chrome-molybdenum-vanadium air hardening steel 45CrMoV7

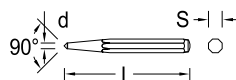

L	s	d	kg	Code	No.
120	10	4	0.063	8721720	100 A-10
130	12	4	0.089	1568396	100 A-12

### 101 AUTOMATIC CENTRE PUNCH

with tip

- > For one hand operation
- > With spring mechanism
- > Impact power can be set by a screw thread
- > With hand protection for comfortable and safe working
- > Spare tip E 101



L	s	d	kg	Code	No.
145	16	4	0.145	8722880	101
		4	0.010	8870800	E 101

# 119 PIN PUNCH

octagonal

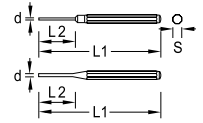

- > Acc. to DIN 6450
- > Chrome-molybdenum-vanadium air hardening steel 45CrMoV7
- > Carefully hardened and tempered along the full length
- > Striking heads inductively tempered
- > Working edge polished and clear varnished
- > No. 119-175 with pilot
- > Special types or sizes on request \* not standardised

d		L <sub>1</sub>	L <sub>2</sub>	s		Code	No.
1.5	*	110	30	8	0.061	2004658	119-1,5
2.0		150	30	10	0.070	8758640	119-2
2.5	*	150	30	10	0.069	8758720	119-2,5
3.0		150	40	10	0.071	8758800	119-3
3.5	*	150	40	10	0.072	8758990	119-3,5
4.0		150	50	10	0.061	8759020	119-4
4.5	*	150	50	10	0.065	8856220	119-4,5
5.0		150	50	10	0.068	8759290	119-5

d		L <sub>1</sub>	L <sub>2</sub>	s		Code	No.
6.0		150	50	10	0.073	8759370	119-6
7.0	*	150	50	12	0.103	8759450	119-7
8.0		150	50	12	0.109	8759530	119-8
9.0	*	150	50	12	0.115	8759610	119-9
10.0		150	50	12	0.123	8759880	119-10
12.0		150	50	14	0.170	8759960	119-12
14.0		180	80	16	0.237	8859670	119-14
6.0		175	85	10	0.070	8761350	119-175

# 114 PIN PUNCH

with guide sleeve

- > Driving point made from material 115CrV3, hardened 55 - 59 HRC
- > With movable guide sleeve
- > Shank knurled, fine grinded and polished
- > The guide tip is attached together with the

pushed-forward guide sleeve. At the expelling stage, the flexible sleeve supports the propelling pin and, at the same time, stops the propelling tip breaking off.

\* No. 114-59 with fix guide sleeve



114-09 - 114-39



114-59

d	L		Code	No.
0.9	80	0.006	8755460	114-09
1.4	85	0.012	8755540	114-14
1.8	88	0.012	8755620	114-18
2.4	92	0.018	8755700	114-24
2.8	96	0.020	8755890	114-28
3.4	96	0.026	8755970	114-34
3.9	100	0.026	8756000	114-39
5.9*	100	0.032	8756190	114-59

# 115 PIN PUNCH SET

8 pieces

- > In metal case with lid
- > With movable guide sleeve, no. 114-59 with fix guide sleeve

- > Driving point made from material 115CrV3, hardened 55 - 59 HRC
- > Shank knurled, fine grinded and polished



Contents		Code	No.
114-09 -14 -18 -24 -28 -34 -39 -59	0.350	8756780	115

## Sets

# 116 A - 116 L PIN PUNCH SET

6 pieces

- > Chrome-molybdenum-vanadium air hardening steel 45CrMoV7
- > Carefully hardened and tempered along the full length
- > Striking heads inductively tempered
- > Working edge polished and clear varnished
- > 116 L = long pattern

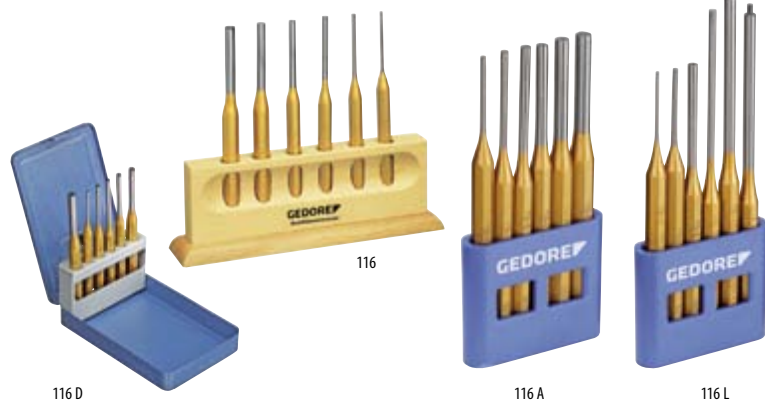

Contents	Execution		Code	No.
119-3 -4 -5 -6 -7 -8	wooden stand	0.714	8757240	116
119-3 -4 -5 -6 -7 -8	metal case with lid	0.820	8758050	116 D

Contents	Execution		Code	No.
119-3 -4 -5 -6 -7 -8	PVC holder	0.530	8757670	116 A
119-2 -3 -5 -175 -175-4 -175-6	PVC holder	0.475	8839990	116 L

## 119 L PIN PUNCH SET

6 pieces

- > Chrome-molybdenum-vanadium air hardening steel 45CrMoV7
- > Carefully hardened and tempered along the full length
- > Striking heads inductively tempered
- > Working edge polished and clear varnished
- > In PVC holder
- > Long pattern 175 mm



Contents	Execution		Code	No.
119-175-4 175-5 175-6 175-7 175-8 175-10	PVC holder	0.580	8866290	119 L

## 106 - 106 D CHISEL AND PUNCH SET

6 pieces

- > Chrome-molybdenum-vanadium air hardening steel 45CrMoV7
- > Carefully hardened and tempered along the full length
- > Striking heads inductively tempered
- > Working edge polished and clear varnished



Contents	Execution		Code	No.
97-125 150 98-125 99 12-3 100-10 119-4	PVC holder	0.525	8725200	106
97-125 150 98-125 99 12-3 100-10 119-4	Metal case with lid	0.805	8725710	106 D

## 113 - 113 D DRIFT PUNCH SET

6 pieces

- > Chrome-molybdenum-vanadium air hardening steel 45CrMoV7
- > Carefully hardened and tempered along the full length
- > Striking heads inductively tempered
- > Working edge polished and clear varnished





Contents	Execution		Code	No.
99 10-1 2 3 99 12-4 5 100-10	PVC holder	0.460	8753680	113
99 10-1 2 3 99 12-4 5 100-10	metal case with lid	0.755	8754060	113 D

## 107 CHISEL AND PUNCH SET

12 pieces

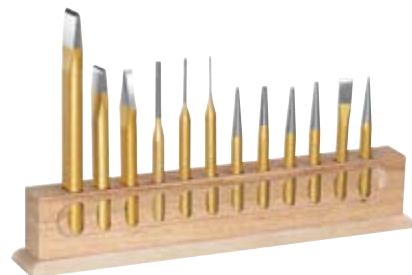
- > Chrome-molybdenum-vanadium air hardening steel 45CrMoV7
- > Carefully hardened and tempered along the full length
- > Striking heads inductively tempered
- > Working edge polished and clear varnished
- > In wooden stand



Contents		Code	No.
95-150 200 96-150 97-125 99 10-2 3 4 5 100-10 119-2 3 5	2.075	8726440	107



various

## 206 TILER'S SETTING TOOL

- > Chrome-vanadium steel 59CrV4
- > Carefully hardened and tempered along the full length
- > Striking heads inductively tempered
- > Working edge polished and clear varnished



↳ mm	■ mm	⚖ kg	Code	No.
150	8	0.070	8880600	206-150

## 90 HS RIVET SETTER

octagonal

- > Chrome-molybdenum-vanadium air hardening steel 45CrMoV7, zinc-plated
- > Carefully hardened and tempered along the full length
- > Striking heads inductively tempered
- > With black protective hand guard for safe comfortable working



L	s	⚖ kg	Code	No.
170	18	0.488	8885830	90 HS-4
170	18	0.488	8886130	90 HS-6

## 208 CARBIDE SCRIBER

hexagonal

- > Chrome-vanadium steel 59CrV4
- > Zinc-plated



↳ mm	■ mm	⚖ kg	Code	No.
150	6	0.040	8881680	208-150

## 126 RIVETTING SETTER

octagonal

- > Acc. to DIN 6434
- > Chrome-molybdenum-vanadium air hardening steel 45CrMoV7
- > Working edge polished and clear varnished



for rivet shaft Ø	internal Ø	L	s	⚖ kg	Code	No.
2	2.5	100	10	0.063	8774090	126-2
3	3.5	100	10	0.061	8774170	126-3
4	4.5	100	12	0.081	8774250	126-4
5	6.0	110	12	0.132	8774330	126-5
6	7.0	110	14	0.130	8774410	126-6

## 127 RIVETTING SNAP DIE

octagonal

- > Acc. to DIN 6435
- > Chrome-molybdenum-vanadium air hardening steel 45CrMoV7
- > Working edge polished and clear varnished



for rivet shaft Ø	internal Ø	L	s	⚖ kg	Code	No.
2	3.5	100	10	0.062	8775060	127-2
3	5.2	100	10	0.063	8775140	127-3
4	7.0	100	12	0.090	8775220	127-4
5	8.8	110	14	0.133	8775300	127-5
6	10.5	110	16	0.173	8775490	127-6

## 125 B SET OF RIVETTING SETTERS AND SNAP DIES

6 pieces

- > Chrome-molybdenum-vanadium air hardening steel 45CrMoV7
- > Hardened in accordance with the technical specifications for striking tools to DIN 7255
- > Working edge polished and clear varnished
- > In PVC holder



Contents	⚖ kg	Code	No.
126-2 3 4	0.470	8773600	125 B
127-2 3 4			

## Bending bars / Prybars

135  
SETTING PUNCH

- > Chrome-vanadium steel 59CrV4
- > Hardened and tempered along the full length
- > Special sizes available on request

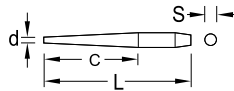

d	L	c	s		Code	No.
5	180	110	12	0.110	8782350	135-5
6	200	120	13	0.150	8782430	135-6
8	200	130	16	0.225	8782510	135-8
9	200	130	20	0.340	8782780	135-9
10	230	140	22	0.490	8782860	135-10
11	250	155	25	0.620	8782940	135-11
12	280	170	27	0.890	8783080	135-12
14	315	190	30	1.250	8783160	135-14
15	340	200	32	1.570	8783240	135-15
16	380	220	36	2.190	8783320	135-16

136-500  
TAPER PUNCH

octagonal

- > Chrome-molybdenum-vanadium air hardening steel 45CrMoV7
- > Carefully hardened and tempered along the full length

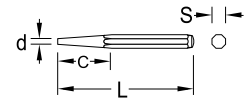

L	c	d	s		Code	No.
500	170	5	20	1.050	8783400	136-500

137-600  
BENDING BAR

octagonal

- > Chrome-molybdenum-vanadium air hardening steel 45CrMoV7
- > Carefully hardened and tempered along the full length

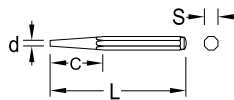

L	c	d	s		Code	No.
600	120	5	20	1.305	8783590	137-600

138-400  
BENDING TOOL

hexagon

- > Chrome-vanadium air hardening steel 59CrV4, zinc-plated
- > Carefully hardened and tempered along the full length



L mm	mm	s		Code	No.
400	23	17	0.645	1396609	138-400

139-400  
PRYBAR

- > Chrome-vanadium-steel 31CrV3, zinc-plated



L mm	Ø		Code	No.
400	14	0.480	1396595	139-400

140-380  
UNIVERSAL PRYBAR

- > Made from special steel, hardened
- > Cutting edge polished
- > With three nail pullers



L mm	mm		Code	No.
380	42	0.650	8894310	140-380

# 141 PRYBAR

octagonal

- > Chrome-vanadium steel 59CrV4, chromated
- > Hardened along the full length
- > With plastic handle
- > Very robust and resilient



l mm r	mm	s	kg	Code	No.
300	15	12	0.230	1471945	141-300
390	15	12	0.390	1471937	141-390
600	15	12	0.785	1471929	141-600

# S 141-3 PRYBAR SET

3 pieces

- > Chrome-vanadium steel 59CrV4, chromated
- > Hardened along the full length
- > With plastic handle
- > Very robust and resilient
- > Packed in cardboard box



Contents	kg	Code	No.
141-300 390 600	1.474	1525476	S 141-3

# 142-430 ALUMINIUM PRYBAR

- > Forged of high-class aluminium
- > Extremely light and very robust
- > For universal use - with pry and tip
- > Sensitive parts can be levered gently



l mm r	mm	kg	Code	No.
430	26	0.405	1859188	142-430

## Nail lifter / Crowbars

# 120 WRECKING BAR

hexagon

- > Made from special steel
- > Working edges carefully hardened and tempered



l mm r	hexagonal	kg	Code	No.
350	18	0.840	8769330	120-350
500	18	1.150	8769410	120-500
600	18	1.355	8769680	120-600
700	18	1.550	8769760	120-700
800	18	1.770	8769840	120-800
1000	18	2.175	8769920	120-1000

# 122 CROWBAR

- > With straight cutting edge and point



l mm r	Ø	kg	Code	No.
1000	30	5.2	8770500	122-1000
1500	30	8.2	8770770	122-1500

# 123 CROWBAR

- > With curved cutting edge and point



l mm r	Ø	kg	Code	No.
1000	30	5.3	8771230	123-1000
1500	30	8.2	8771580	123-1500

# 124 CROWBAR

- > With claw and point



l mm r	Ø	kg	Code	No.
1000	30	5.2	8772040	124-1000
1500	30	8.2	8772200	124-1500

# 151 CROWBAR

- > Heavy-duty model
- > With round head and cutting edge



l mm r	Ø	kg	Code	No.
1500	30	8.4	8824880	151-1500



**GEDORE**

No. 407 A

**B-METALL**  
Made in UE

# WORKSHOP SUPPLIES

## AUTOMOTIVE TOOLS

>534



## EQUIPMENT

>551



## FILES, SAWS

>552



## VARIOUS

>553



## PARALLEL VICES

>554



## MEASURING TOOLS

>554



## THREAD WORKINGS

>557



## INDUSTRIAL CUTLERY

>562



## AT WORK

>565



## Tyre fitting / removal

- > For the controlled tightening of wheel nuts or studs, we recommend torque wrenches
- > For truck wheels, we specially recommend the DR-LKW torque wrench



## FOUR-WAY WHEEL WRENCH

- > Hot forged hexagon
- > The collar, typical of GEDORE 4-way wheel wrenches, enlarges the welding area.
- > The positive-fit joint remains solid even under extreme loading..



### 28 CU 4-WAY WHEEL WRENCH FOR SMALL TRUCKS

- > For delivery vans and light trucks, buses and tractors
- > Acc. to DIN 3119, ISO 6788
- > GEDORE vanadium steel 31CrV3
- > GEDORE grey powder-coated
- > Dimensions: 600 x 600 mm



mm	mm	kg	Code	No.
19x24x22x27 (3/4x15/16x7/8x1.1/16")	28,5x32x34,5x38,5	3.155	6228500	28 CU

### 28 LM - LV 4-WAY WHEEL WRENCH FOR TRUCKS



- > For trucks, agricultural machines, tractors and industrial uses
- > Acc. to DIN 3119, ISO 6788
- > GEDORE vanadium steel 31CrV3
- > GEDORE grey powder-coated
- > Dimensions: 750 x 750 mm



mm	mm	kg	Code	No.
24x27x30x32	34,5x38,5x42x45	5.555	6228770	28 LM
24x32x27x3/4" 4kt	34,5x45x38,5x26	5.515	6229150	28 LV

## 28 LR + 28 LRV 4-WAY WHEEL WRENCH FOR TRUCKS

- > For trucks and heavy machines
- > With turned centre, especially sturdy
- > GEDORE vanadium steel 31CrV3, chrome-plated
- > Dimensions: 750 x 750 mm



Ø mm	Ø mm	kg	Code	No.
27x30x32x33	40x44x46x46	6.085	6228930	28 LR
27x30x32x3/4" 4kt	40x44x46x26	5.980	6228420	28 LRV

## 28 PKH 2-WAY WHEEL WRENCH FOR CARS

- > An indispensable tool for all usual car wheel nuts
- > With a protective central reinforcement (DBGM = German utility patent)
- > Practical and strong, with long lever arm, a space-saver in the car boot
- > GEDORE vanadium steel 31CrV3, chrome-plated
- > Dimensions: 410 x 260 mm



Ø mm	Ø mm	kg	Code	No.
17x19 (3/4")	26x28,5	1.020	6227290	28 PKH

## 28 PR + 28 PRV UNIVERSAL 4-WAY WHEEL WRENCH

for cars and small trucks

- > Acc. to DIN 3119, ISO 6788
- > With solid turned centre, for the car and truck workshop
- > With extra long lever arm and great range of sockets
- > GEDORE vanadium steel 31CrV3, chrome-plated
- > Dimensions: 550 x 550 mm

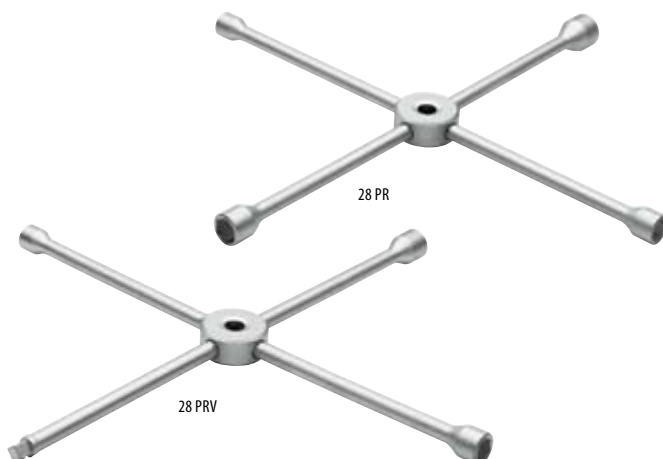

Ø mm	Ø mm	kg	Code	No.
17x19 (3/4")x21x24	26x28,5x30,5x35,5	2.315	6227530	28 PR
17x19 (3/4")x21x1/2" 4kt	26x28,5x30,5x17,5	2.255	6227880	28 PRV

## 28 PU + 28 PUV 4-WAY WHEEL WRENCH FOR CARS

- > For car wheel nuts in metric and inch sizes
- > Acc. to DIN 3119, ISO 6788
- > With protective central reinforcement (DBGM = German utility patent)
- > GEDORE vanadium steel 31CrV3
- > GEDORE grey powder-coated
- > Dimensions: 420 x 420 mm

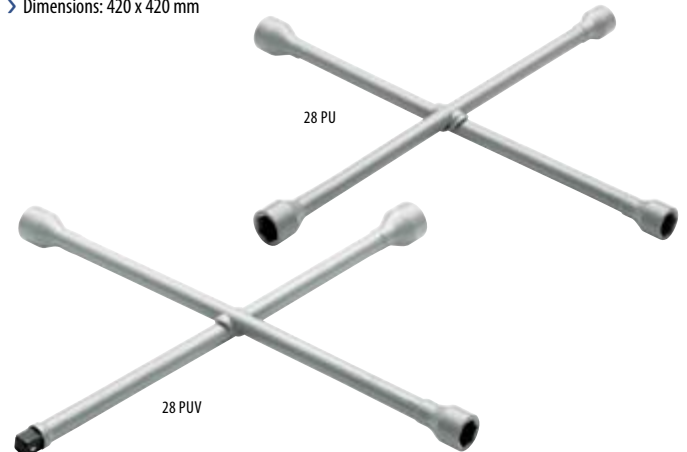

Ø mm	Ø mm	kg	Code	No.
17x19 (3/4")x21x11/16"	26x28,5x30,5x26	1.285	6227610	28 PU
17x19 (3/4")x21x1/2" 4kt	26x28,5x30,5x17,5	1.315	6228260	28 PUV



## 27 WHEEL SOCKET WRENCH FOR TRUCKS

- > With great head depth, for protruding bolts, without tommy bar
- > GEDORE vanadium steel 31CrV3, chrome-plated
- > Please order tommy bar 27 D separately

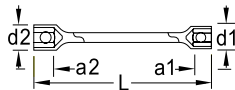

mm	"AF	L	a <sub>1</sub>	a <sub>2</sub>	d <sub>1</sub>	d <sub>2</sub>	Ø	kg	Code	No.
24 x 27	15/16 x 1.1/16	400	34.5	34.5	36	40	1.148	6225240	27 24x27	
27 x 32		400	34.5	34.5	40	46	1.453	6220010	27 27x32	
28 x 32		400	34.5	34.5	41	46	1.134	6220280	27 28x32	
30 x 32	1.3/16 x 1.1/4	400	34.5	34.5	44	46	1.459	6225910	27 30x32	
30 x 33		400	34.5	34.5	44	47	1.442	6220440	27 30x33	
		630					18	1.260	6227100	27 D

## 8276 BALANCE WEIGHT PLIERS

- > For removing, cutting, and attaching balancing weights
- > GEDORE vanadium steel 31CrV3



mm	inch	kg	Code	No.
250	10	0.386	6739350	8276-250 C

K 19 LS / K 19 LS-004

>238



## 38 TYRE LEVER

- > Profiled pattern, forged from solid stock
- > With protective surfaces for light-alloy wheels
- > GEDORE vanadium steel 31CrV3, chrome-plated



mm	inch	kg	Code	No.
200	8	0.099	6332320	38 8
305	12	0.221	6332400	38 12
400	16	0.405	6332670	38 16
500	20	0.602	6332830	38 20
610	24	0.927	6332910	38 24

## 39 TYRE LEVER

heavy-duty pattern

- > Heavy-duty, offset pattern
- > GEDORE vanadium steel 31CrV3, chrome-plated



mm	inch	kg	Code	No.
610	24	1.365	6333050	39

## Brakes

### 135 BRAKE SPRING PLIERS

- > For drum brakes
- > With special holder and support crown, particularly suitable for glued brake linings
- > GEDORE vanadium steel 31CrV3, chrome-plated



↳ mm ↲	↳ inch ↲	⚖️	Code	No.
330	13	0.389	6405300	135 13
480	19	0.956	6405490	135 19

### 135 BRAKE SPRING PLIERS

heavy-duty pattern

- > For drum brakes
- > With replaceable spring hooks (E-135 20) and hand protectors
- > GEDORE vanadium steel 31CrV3, chrome-plated



↳ mm ↲	↳ inch ↲	⚖️	Code	No.
500	20	1.058	6400180	135 20
		0.016	5400480	E-135 20

### 643 BRAKE CALIPER BRUSH

- > For cleaning all brake calipers
- > With blue plastic handle



↳ mm ↲	Bristle length	⚖️	Code	No.
225	21	0.094	6531440	643

### 8726 BRAKE CALIPER FILE



↳ mm ↲	↳ inch ↲	⚖️	Code	No.
260	10	0.131	6770780	8726

## Oil service

### 298 OIL CAN

- > 298-00 / 298-01 Plastic oil can with sliding brass tube and cap
- > 298-02 simple oil can in plastic



298-00



298-01



298-02

Litre	Pint	⚖️	Code	No.
0.250	1/2	0.979	6390010	298-00
0.125	1/4	0.074	6390280	298-01
0.025	1/16	0.010	6390360	298-02

### 298-04 OIL CAN

- > Strong, cast iron pattern with pump, 300 ml



Litre	Pint	⚖️	Code	No.
0.3	5/8	0.492	6390520	298-04

### 299 DRAIN PLUG WRENCH

- > For square plugs on engine sumps and oil drums, in nine common sizes
- > GEDORE vanadium steel 31CrV3, chrome-plated
- > 5 square sizes: 8.7, 9.5, 10.5, 11.5, 13 mm
- > 4 tapered sizes: 6.8-8.7, 10.5-13, 15.2-18, 16.5-19 mm
- > One screwdriver blade: 5.5 x 18 mm



↳ mm ↲	⚖️	Code	No.
220	0.459	6464580	299

## V-Belts / Filters

## 36 STRAP WRENCH

- > With strong, non-slip fabric strap (E-36), extra wide = 25 mm
- > 36 1-140 made from C45 steel
- > 36 2-200 made from GEDORE vanadium steel 31CrV3
- > Chrome-plated



36 2-200

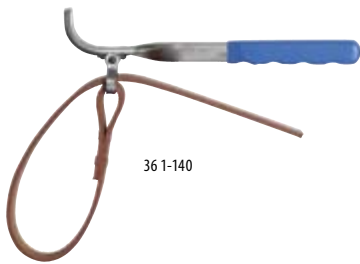

36 1-140

Ø mm	Ø inch	l mm	mm	kg	Code	No.
140	5.1/2	220	25	0.278	6327320	36 1-140
200	8	285	25	0.578	6327400	36 2-200

## E-36 SPARE STRAP

- > Strong, non-slip fabric strap, extra wide = 25 mm



l mm	mm	kg	Code	No.
480	25	0.062	5327380	E-36 1-140
900	25	0.104	5327460	E-36 2-200

## 36 Z SPECIAL STRAP WRENCH

- > For tightening and counter-holding V-belt pulley wheels
- > Spare strap E-36 Z



l mm	Ø mm	Ø inch	kg	Code	No.
257	160	6	0.379	6320070	36 Z-140

## E-36 Z SPARE STRAP

l mm	kg	Code	No.
257	0.080	1380613	E-36 Z-140

## 37 UNIVERSAL FILTER WRENCH

- > For all usual oil filters and round screwed unions
- > Adjustable metal strap, nickel-plated
- > With handle



mm	l mm (appr.)	kg	Code	No.
80-110	285	0.349	6327670	37

## 37 V UNIVERSAL FILTER WRENCH

- > For all usual oil filters and round screwed unions
- > Adjustable metal strap, nickel-plated
- > With 1/2" square drive for all 1/2" tools



mm	l mm (appr.)	kg	Code	No.
80-110	150	0.265	6327750	37 V

Pistons / Valves

## 654 VALVE GRINDER

- > With automatic reversal of lapping direction
- > For use in hand drills
- > Supplied with suction cups 652-20, -25, -30, -37



∅ mm	l mm	kg	Code	No.
65	135	0.750	6535270	654

## 653 VALVE LAPPING TOOL

- > Hand-held type with suction cup 652-25
- > Beech wood handle



∅ mm	l mm	kg	Code	No.
25	225	0.050	6532680	653

## 652 SPARE RUBBER SUCTION CUP for 653 and 654



∅ mm	l mm	kg	Code	No.
20	38	0.010	6530120	652-20
25	38	0.011	6532410	652-25
30	38	0.012	6530200	652-30
37	38	0.016	6530390	652-37

## 124 PLIERS FOR VALVE SEALS

- > For pulling valve shaft sealing rings and removing valve spring supports
- > For VW Audi, BMW, Mercedes, Opel, Ford, Nissan etc.
- > Gun-metal finish, handles chrome-plated



l mm	l inch	kg	Code	No.
250	10	0.348	6399310	124

## 128 VALVE SPRING COMPRESSOR

- > For overhead valve engines
- > With one pair each of straight and offset hooks
- > Bright nickel-plated



l mm	l inch	mm	inch	kg	Code	No.
290	11.1/2	60-225	2.3/8-9	1.326	6398500	128 2-225
390	15	120-280	4.3/4-11.1/2	3.200	6398690	128 1-280

## 125 PISTON RING COMPRESSOR

- > In special band spring steel, with continuous adjustment
- > With clamping wrench



125 0

125 1 / 125 2

125 3

Ø mm	↳ mm ▶	↳ "inch ▶	⚖ kg	Code	No.
40-75	50	2	0.115	6396720	125 0
57-125	80	3	0.257	6396800	125 1
90-175	80	3	0.294	6396990	125 2
90-175	165	6.1/2	0.548	6397020	125 3

## 126 PISTON RING PLIERS

- > With prism holder for secure fitting of piston rings
- > With adjusting screw
- > Bright nickel-plated



Ø mm	↳ mm ▶	↳ "inch ▶	⚖ kg	Code	No.
30-60	210	8.1/4	0.158	6397100	126 0-60

## 126 PISTON RING PLIERS

- > For securely fitting piston rings
- > Handles blue coated
- > Bright nickel-plated



Ø mm	↳ mm ▶	↳ "inch ▶	⚖ kg	Code	No.
55-100	200	8	0.296	6397370	126 1-100
80-120	240	9.1/2	0.344	6397450	126 2-120
110-160	240	9.1/2	0.402	6397530	126 3-160

## 127 PISTON RING PLIERS

- > With prism holder for safe piston ring spreading
- > In special steel
- > Prism holders hardened
- > Chrome-plated, tips gun-metal finish



Ø mm	↳ mm ▶	↳ "inch ▶	⚖ kg	Code	No.
60-160	220	8.5/8	0.207	6397610	127

## Pistons / Valves

## 132 HOSE CLAMP PLIERS

- > For self-clamping hose clamps
- > Handles chrome-plated



↳ mm ▶	↳ "inch ▶	⚖ kg	Code	No.
220	8.3/4	0.215	6399900	132

## 132-2 HOSE CLAMP PLIERS

- > Rotating v-jaws for spring hose clamps with flat butt ends
- > The pliers allow the clamp to be opened and closed without damaging the hose, even in hard-to-reach areas
- > For use on VAG-vehicles (e.g. VW, Audi, Škoda, Seat)
- > Made from steel sheet, nickel-plated



↳ mm ▶	⚖ kg	Code	No.
207	0.192	1894382	132-2

## 132-3 HOSE CLAMP PLIERS

- > Rigid v-jaws
- > For use on VAG-vehicles (e.g. VW, Audi, Škoda, Seat)
- > Made from steel sheet, nickel-plated



↳ mm	⚖ kg	Code	No.
195	0.165	1894390	132-3

## 132-4 HOSE CLAMP PLIERS CLIC

- > With revolving locking bolts for CLIC hose clamps
- > To open or close, just turn the plier by 180 degrees
- > The pivotable bolts enable the usage even in hard-to-reach areas
- > CLIC hose clamps are used on rubber and silicone hoses (e.g. automotive industry for fuel-, oil- and cooler-systems)
- > Made from steel sheet, nickel-plated



↳ mm	⚖ kg	Code	No.
210	0.181	1894404	132-4

## 132 CLIC HOSE CLAMP PLIERS

- > For CLIC-R hose clamps
- > Polished, bright nickel-plated, joint gun-metal finish
- > Forged execution for clamp diameter 5 - 30 mm



↳ mm	↳ inch	⚖ kg	Code	No.
180	7	0.247	1396714	132 CLIC

## 134 HOSE CLAMP PLIERS

- > With self-adjusting joint, DBGM (= German utility patent)
- > Angled jaw
- > Bright nickel-plated, joint gun-metal finish



↳ mm	↳ inch	⚖ kg	Code	No.
180	7	0.411	6391330	134

## 134 B HOSE CLAMP PLIERS

- > Bowden-cable operation
- > With self-adjusting joint, DBGM (= German utility patent)
- > Angled jaw
- > Bright nickel-plated, joint gun-metal finish



↳ mm	↳ inch	⚖ kg	Code	No.
180	7	0.596	6390950	134 B

## 8272 UNIVERSAL PLIERS

- > With adjustable joint and protection against clamping
- > Non-slip handles, slightly angled jaw position
- > In heat-treated steel as per EN 10083





↳ mm	↳ inch	⚖ kg	Code	No.
165	6	0.189	6738620	8272-165 C
200	8	0.259	6738890	8272-200 C

## Voltage tester

4610  
CAR LIGHT TESTER

- > For testing 6-24 Volt
- > Compact brass model
- > With cable and alligator crimp







Measuring range			Code	No.
6-24 V	125	0.069	6698570	4610

4611  
VOLTAGE TESTER

- > For 6-24 Volt
- > With cable and alligator crimp



mm 				Code	No.
3.0	55	115	0.026	6698650	4611

4612  
VOLTAGE TESTER

- > For 3-48 V
- > Use: automobile, utility vehicles
- > LED displays the voltage in the area of 12, 24, 48 V as well as the polarity
- > For work in confined areas
- > TÜV and GS tested, IEC / EN 61010-1 (DIN VDE 0411)
- > Measurements: 145 x 25 x 16mm
- > Protection classification IP40, protection class III



Measuring range		Code	No.
3-48 V	0.120	1881647	4612

4615

&gt;579



VDE 4616

&gt;579



## Lifters

121-2  
SUCTION CUP LIFTER

with 2 cups

- > With suction mechanism and safety locking
- > In ABS, resistant to oil and acids
- > Fixed suction cups
- > Also suitable for transporting slightly textured surfaces
- > Lifting capacity 60 kg



Ø		Code	No.
120	0.580	2979276	121-2

NEW

121-3  
SUCTION CUP LIFTER

with 3 cups

- > Increased lifting safety with three fixed suction cups
- > Aluminium, enamelled blue
- > Lifting capacity 100 kg

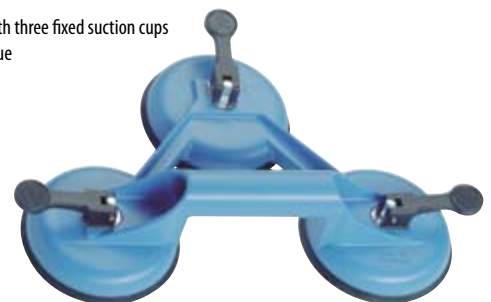

Ø		Code	No.
120	1.403	6390790	121-3



## 121 G SUCTION CUP LIFTER

with 2 cups

- > With suction mechanism and safety locking
- > In ABS, resistant to oil and acids
- > Movable suction cups
- > Particularly suitable for curved panes
- > Lifting capacity 45 kg



↳ mm ↲	∅	⚖	Code	No.
390	120	0.642	6391170	121 G

## 121 G-3 SUCTION CUP LIFTER

with 3 cups

- > Three movable suction cups, resistant to oil and acids, in ABS
- > Particularly suitable for curved panes
- > Cups blue colour, handle black aluminium
- > Lifting capacity 100 kg



∅	⚖	Code	No.
120	1.345	6390870	121 G-3

## 640 MINI MAGNETIC LIFTER

- > Flexible thin shaft for the smallest apertures



↳ mm ↲	Diameter of magnet	Ω	⚖	Code	No.
400	3	120	0.024	6530630	640-120
400	4	270	0.025	1785338	640-270



## 640 MAGNETIC LIFTER

- > With flexible shaft and plastic handle
- > Bright nickel-plated



640-500



640-1800

↳ mm ↲	Diameter of magnet	Ω	⚖	Code	No.
460	10.0	500	0.095	6531010	640-500
520	12.0	1800	0.230	6531280	640-1800
520	16.5	3000	0.275	6531360	640-3000



## 641 CLAW GRIPPER

- > With flexible shaft for grasping small parts
- > Also suitable for inserting split pins, dowels, etc. in confined areas
- > Max. gripping capacity 14 mm



↳ mm ↲	∅	⚖	Code	No.
540	7	0.103	6531520	641

## 642 SP MAGNETIC LIFTER

with lamp, mirror and clip

- > For searching and lifting small metal parts in confined areas
- > If necessary, the magnet can be removed
- > Mirror diameter 30 mm



↳ mm ↲	Diameter of magnet	Ω	⚖	Code	No.
500	12	350	0.172	6536750	642 SP

## Spark Plugs

### D 48 SPARK PLUG SOCKET WRENCH



- > Double ended
- > Forged from solid stock
- > With fully pivoting sheet metal covered lever
- > With sheet clip
- > GEDORE vanadium steel 31CrV3, chrome-plated

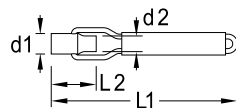

mm	"AF	L <sub>1</sub>	L <sub>2</sub>	d <sub>1</sub>	d <sub>2</sub>	kg	Code	No.
16 x 20,8	5/8 x 13/16	232	56	27.5	21.5	0.233	6360100	D 48

### DS 49 SPARK PLUG SOCKET WRENCH



- > With rubber holder and offset bores
- > Forged and hardened, chrome-plated
- > With angled tommy bar No. 49 D Ø 8 mm
- > In seamless precision tubing as per DIN 2391-ST 55, chrome-plated

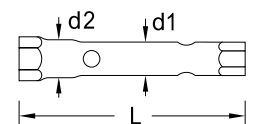

mm	"AF	L	d <sub>1</sub>	d <sub>2</sub>	kg	Code	No.
16 x 20,8	5/8 x 13/16	190	24	25	0.324	6361340	DS 49 R

### 50 - 57 SPARK PLUG SOCKET

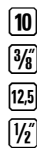

- > With retention spring
- > For use in confined areas, with jointed tools 3/8" or 1/2" square drive or tommy bar Ø 8 mm
- > GEDORE vanadium steel 31CrV3, polished head, chrome-plated

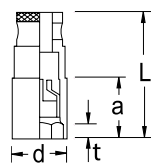

mm	"AF	"	L	t	a	d	kg	Code	No.
20.8	13/16	1/2	63.5	7	25.5	27.5	0.136	6361690	50
20.8	13/16	3/8	63.5	7	25.5	27.5	0.148	6362580	52
16.0		3/8	63.5	7	20.5	21.5	0.103	6362740	53
16.0		1/2	63.5	7	20.5	21.5	0.095	6363040	54
18.0		3/8	63.5	7	20.5	23.5	0.138	6361770	56
18.0		1/2	63.5	7	20.5	23.5	0.125	6361930	57

### 50 MH - 59 MH SPARK PLUG SOCKET

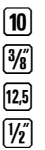

with magnet

- > With two magnets
- > For use in confined spaces with jointed tools 3/8" or 1/2" square drive or tommy bar Ø 8 mm
- > With powerful magnets in the hexagon surface, which hold the spark plug safely on the hexagon
- > Wide opening gives space to the spark plug and makes it easier to put on the socket in confined areas
- > The ceramic core of the spark plug remains untouched
- > GEDORE vanadium steel 31CrV3, chrome-plated, polished head



57 MH



50 MH

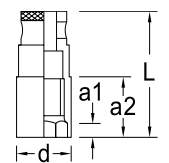

mm	"AF	"	L	a <sub>1</sub>	a <sub>2</sub>	d	kg	Code	No.
20.8	13/16	1/2	64	7	30.5	27.5	0.136	6361420	50 MH
20.8	13/16	3/8	64	7	30.5	27.5	0.146	6361500	52 MH
16.0		3/8	64	7	30.5	21.5	0.100	6363390	53 MH
16.0		1/2	64	7	30.5	21.5	0.094	6363470	54 MH
18.0		3/8	64	7	30.5	23.5	0.137	6361850	56 MH
18.0		1/2	64	7	30.5	23.5	0.127	6362150	57 MH
13.0		3/8	64	7	30.5	18.0	0.074	6366220	59 MH

## SAFETY NOTES



- > For engines with ignition coils integrated in the spark-plug connector (coil-on-plug), use only spark-plug sockets with retainer springs! (Nos. 50 - 57)
- > Do not use magnetic spark-plug spanners on coil-on-plug spark plugs!
- > This can result in control unit faults!

## S 51 GU SET OF SPARK PLUG SOCKETS 3/8"

10 pieces

- > 4 spark plug sockets with magnets, 1 socket with UD profile
- > Reversible ratchet with flexible head and fine tooth mechanism, 3/8" square drive
- > 3 extensions, 1 universal joint
- > GEDORE vanadium steel 31CrV3
- > In GEDORE blue sheet steel case
- > Dimensions: 320 x 210 x 55 mm

Contents		Code	No.
52 MH 53 MH 56 MH 59 MH D 55 3093 GU-3 3090-3 -5 -10 3095	2.523	1795554	S 51 GU



## D 55 SPARK PLUG SOCKET 3/8"

UD profile

- > With retention spring
- > For use with jointed tools 3/8" square drive or tommy bar Ø 8 mm



Ø mm	"	□	L	t	a	d		Code	No.
14	3/8	10	63.5	7.0	22.5	19.2	0.068	1793586	D 55

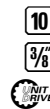

## PR 265 SPARK PLUG SOCKET WRENCH

- > With tommy bar 26 D 8 and 1/2" square drive for use with the torque wrenches
- > Particularly suitable for Renault and Peugeot



Ø mm	"AF	L	d		Code	No.
16.0	5/8	270	20.2	0.250	6646340	PR 265

## 647 SPARK PLUG BRUSH

- > With wooden handle and brass wire bristles



↳ mm	Bristle length		Code	No.
180	15	0.022	6531950	647

## 648 SPARK PLUG BRUSH

- > With plastic handle and brass wire bristles



↳ mm	Bristle length		Code	No.
100	14	0.009	6532090	648

## Exhaust / Engine / Various

## 224

### RATCHET PIPE CUTTER NIRO

for stainless steel pipes

- › Low space requirements, therefore highly suitable for working on vehicle exhaust gas systems
- › Body in zinc-plated pressure-cast aluminium
- › Easy handling via ratchet feed with automatic infeed of the cutting wheel with every rotation
- › Cutting wheel made from high-alloy stainless steel, with high service life
- › One spare cutting wheel in addition



Ø mm	Wall thickness	l mm	kg	Code	No.
16-35	1,0-3,0	260	0.930	1600877	224011
25-66	1,0-3,0	360	1.710	1600885	224021

## 4589

### CHAIN PIPE CUTTER

- › For pipes with Ø 75 mm and wall thickness 2.6 mm
- › Also suitable for stainless steel pipes
- › Spare chain E 4589 A



Ø mm max.	length appr.	kg	Code	No.
80	246	0.909	1446940	4589
	315	0.200	1446959	E-4589 A

## E 224

### SPARE PARTS



224611



224211

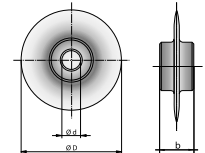

Description	Ø D	b	Ø d	kg	Code	No.
Cutting wheel size 1 + 2	26	6.3	4.8	0.007	1621440	224211
Wheel bolt size 1 + 2				0.003	1621459	224611

## 614

### ANTI-FREEZE TESTER

- › For ethylene glycol mixtures
- › Practical, reliable apparatus with high measuring accuracy
- › Easy-to-read scale with degrees Celsius
- › Made from high-quality impact-resistant plastics
- › Corrosion-proof
- › Suction tube length: 185 mm



kg	Code	No.
0.150	6523770	614

## 8134

### INSTALLATION PLIERS

- › For spreading of horseshoe pattern circlips of shaft retainers, on motors, gearboxes, clutches, etc.
- › For VW, AUDI and American vehicles
- › GEDORE vanadium steel 31CrV3



l mm	l inch	kg	Code	No.
170	6.3/4	0.191	6722030	8134-170 C

## Car body work

### 269 BODYWORK FILE

- > With light-alloy handle and flexible milled file blades
- > **269 K** complete with 269 F 9
- > **269 L** without milled file blade



### 269 F FLEXIBLE MILLED FILE BLADES



Execution		Code	No.
<b>complete</b>	1.050	6460080	269 K
<b>without file blade</b>	0.614	6460160	269 L

Teeth "	Execution	l mm		Code	No.
<b>7</b>	extra coarse	354	0.249	5460030	269 F 7
<b>9</b>	coarse	354	0.289	5460110	269 F 9
<b>12</b>	fine	354	0.303	5460380	269 F 12

### 252 - 288 PLANISHING HAND ANVILS

- > Made from hardened and tempered steel to EN 10083
- > Enamelled, with ground faces

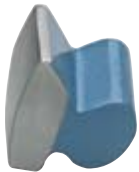

252



253



254



255



259



281



282



285



288

Measurements		Code	No.
<b>72 x 55 x 63</b>	1.206	6456990	252
<b>Ø 58.5 x 60</b>	0.844	6457020	253
<b>80 x 60 x 33</b>	1.070	6457100	254
<b>120 x 58 x 23</b>	0.942	6457290	255
<b>125 x 55 x 25</b>	1.028	6457610	259

Measurements		Code	No.
<b>130 x 55 x 36</b>	0.933	6461720	281
<b>100 x 40 x 80 x 70 x 62</b>	1.372	6461800	282
<b>111 x 68 x 23.5</b>	0.999	6462020	285
<b>104 x 66 x 25</b>	0.987	6463340	288

## 289 - 291 BODYWORK SPOON

- > Made from hardened and tempered steel to EN 10083
- > Enamelled, with ground faces

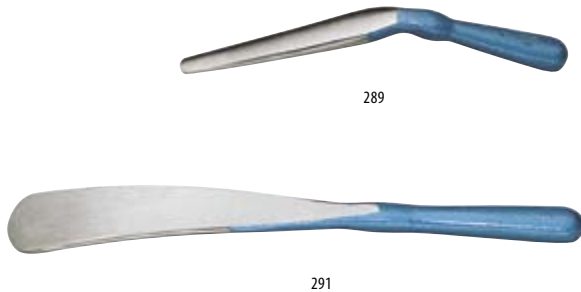

mm	inch	kg	Code	No.
275	11	0.545	6463420	289
390	16	1.014	6463690	291

## 292 - 293 BODYWORK LEVER

- > GEDORE vanadium steel 31CrV3
- > Enamelled, with ground faces

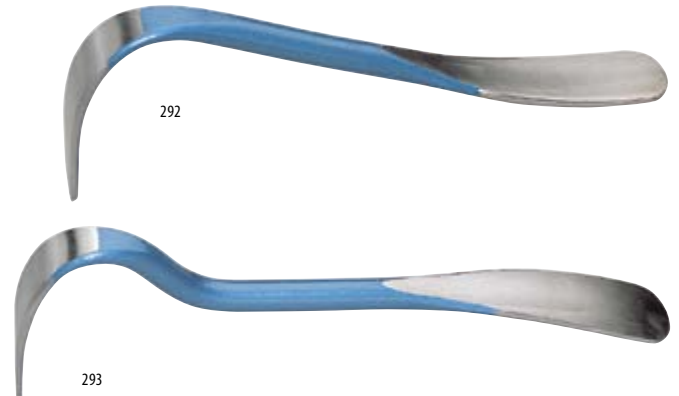

mm	inch	kg	Code	No.
450	16	1.888	6463770	292
500	19	2.186	6463850	293

## 251 FLAT ROUND FACE HAMMER

- > With ergonomic ash handle (E-251 E)
- > Made from hardened and tempered steel to EN 10083
- > Enamelled blue, with ground faces



### E-251 E SPARE HANDLE ASH

mm	mm	mm	mm	Spare handle	kg	Code	No.	mm	kg	Code	No.
300	155	40	31	E-251 E	0.497	6456720	251	300	0.111	1808621	E-251 E

## 261 PLANISHING HAMMER

- > With ergonomic ash handle (E-261 E)
- > Made from hardened and tempered steel to EN 10083
- > Enamelled blue, with ground faces



### E-261 E SPARE HANDLE ASH

mm	mm	mm	Spare handle	kg	Code	No.	mm	kg	Code	No.
325	160	31	E-261 E	0.512	6457960	261	325	0.111	1440934	E-261 E

## 272 - 273 SMOOTHING HAMMER

- > With ergonomic ash handle (E-251 E)
- > Made from hardened and tempered steel to EN 10083
- > Enamelled blue, with ground faces
- > The K models have one milled cross-hatched face and one smooth square face



↳ mm ▶	┆ mm	● mm	■ mm	Spare handle	⚖	Code	No.
300	105	32	25	E-251 E	0.306	6460400	272
300	105	32	25	E-251 E	0.322	6460590	272 K
300	100	40	35	E-251 E	0.403	6460670	273
300	100	40	35	E-251 E	0.395	6460750	273 K

## 275 - 276 EMBOSSING HAMMER

- > With ergonomic ash handle (E-251 E)
- > Made from hardened and tempered steel to EN 10083
- > Enamelled blue, with ground faces



↳ mm ▶	┆ mm	● mm	Spare handle	⚖	Code	No.
300	160	40	E-251 E	0.446	6461050	275
300	160	40	E-251 E	0.446	6461130	276

## 277 POINT PEIN HAMMER

- > With ergonomic ash handle (E-251 E)
- > Made from hardened and tempered steel to EN 10083
- > Enamelled blue, with ground faces



↳ mm ▶	┆ mm	● mm	Spare handle	⚖	Code	No.
300	137	37	E-251 E	0.331	6461210	277

## 278 PLANISHING / GROOVING HAMMER

- > With ergonomic ash handle (E-251 E)
- > Made from hardened and tempered steel to EN 10083
- > Enamelled blue, with ground faces



↳ mm ▶	┆ mm	● mm	Spare handle	⚖	Code	No.
300	160	40	E-251 E	0.406	6461480	278



## Bodywork tool sets

Professional selection of tools

Available loose or in a sturdy steel case, powder-coated blue hammer finish

### 260 BODYWORK TOOL SET

8 pieces

- > Workshop selection
- > Well-chosen workshop assortment for universal use
- > In sheet steel case
- > Dimensions: 525 x 206 x 78 mm



Contents	⚖️	Code	No.
251 252 253 254 255 281 273 K 226 E-2 + WK 260 L	8.9	6457880	260
251 252 253 254 255 281 273 K 226 E-2	6.7	6459150	S 260

### 280 BODYWORK TOOL SET

12 pieces

- > Large workshop assortment
- > Good selection of the most common bodywork tools
- > In sheet steel case
- > Dimensions: 545 x 230 x 110 mm



Contents	⚖️	Code	No.
272 K 273 K 277 278 281 282 288 291 292 293 259 225 E-32 + WK 280 L	15.4	6461640	280
272 K 273 K 277 278 281 282 288 291 292 293 259 225 E-32	11.8	6462290	S 280

## Sheet metal forming tools

### 8532 OFFSETTING PLIERS WITH PUNCH

- > Combination pliers for offsetting sheet metal edges up to 1 mm and for punching sheet metal for spot welding
- > The rotating head makes both operations possible using one tool
- > Single-handed, low-force operation

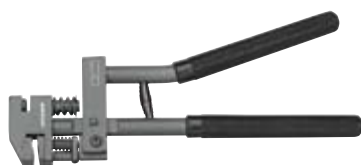

● mm	⌀ mm	└ mm ┘	⚖️	Code	No.
22	5	325	1.258	6751130	8532

### 8533 PUNCH PLIERS

- > With adjustable stop for punching sheet metal up to 1.5 mm

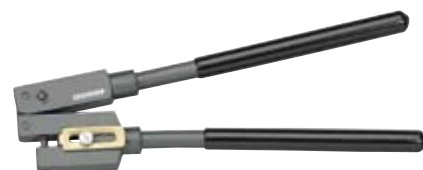

● mm	⌀ mm	└ mm ┘	⚖️	Code	No.
up to 30	5	260	0.955	6751640	8533

# 2200 - 2201

## LETTER AND NUMBER PUNCHES

- > To label finished parts such as signs, tools, etc.
- > Made from hardened steel with hardened handle and tempered striking head
- > In blue plastic box
- > No. 2200 = 9 numbers, 6 mm printing height
- > No. 2201 = 27 letters (A - Z, &), 6 mm printing height

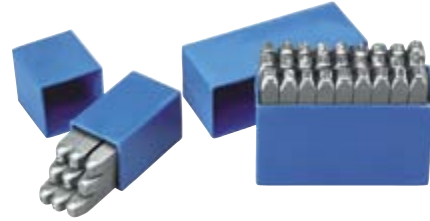

↳ mm ▷	■ mm	⚖ kg	Code	No.
70	9	0.415	8605140	2200-6
70	9	1.240	8605220	2201-6

## Equipment

### 905

#### CREEPER

- > Comfortable, ergonomically shaped one-piece creeper
- > With practical carrying handle
- > Made from PP (polypropylene) - kind on the skin, resistant to oil, grease and brake fluid
- > Six swivel castors ensure easy and safe manoeuvrability
- > Fatigue-free working, with head/neck cushion for maximum comfort
- > Bucket moulding gives additional hold and allows maximum freedom of movement
- > Two storage trays (right/left) to keep tools and small parts within easy reach
- > Carrying capacity: 130 kg
- > Temperature range -30 °C to +60 °C
- > Dimensions: 1030 x 480 x 115 mm



L	W	H	⚖ kg	Code	No.
1030	480	115	5.0	1823698	905

### 906

#### KNEELING BOARD

- > Made from solid foam, blue/black
- > With indented grip
- > Dimensions: 450 x 210 x 30 mm



L	W	H	⚖ kg	Code	No.
450	210	30	0.110	1942948	906

### 907

#### WING PROTECTOR

- > Protection from unwanted scratches, dents and dirt
- > Magnetic attachment keeps paintwork safe from damage - also attaches to galvanised steel sheet
- > Rugged, padded imitation leather and reinforced edges provide a perfect, cushioned working area
- > Dimensions: 1100 x 650 mm with wheel cut-out to allow free access



L	W	⚖ kg	Code	No.
1100	650	0.620	1942956	907

## Files

### 8729 CONTACT FILE

> In blue PVC tear-off wallet



↳ "inch	↳ mm	Cut	⚖️	Code	No.
6	150	2	0.009	6771080	8729

### 8701 HAND FILE

> PVC handle  
> DIN 7261, Form A  
> Cut: 2



L	L"	W	H	Cut	⚖️	Code	No.
150	6	16	4	2	0.096	6768020	8701 2-6
200	8	20	5	2	0.183	6768100	8701 2-8
250	10	25	6	2	0.323	6768290	8701 2-10

### 8722 ROUND FILE

> PVC handle  
> DIN 7261, Form F  
> Cut: 2



∅	Cut	L	L"	⚖️	Code	No.
6.0	2	150	6	0.057	6770000	8722 2-6
7.5	2	200	8	0.112	6770190	8722 2-8
9.5	2	250	10	0.186	6770270	8722 2-10

### 8730 DEBURRER

> A valuable helper for removing burr on a wide range of different materials  
> The small, free-turning deburring knife adjusts to the contour of the workpiece and removes burr

**Consisting of:**

> 676 Driving handle  
> 699 Bit holder  
> E-8730 Deburrer bit 1/4" hex



Description	⚖️	Code	No.
<b>Deburrer</b>	0.090	2190907	8730
<b>Deburrer bit 1/4" hex</b>	0.005	2190915	E-8730

### 8728 KEY FILE SET

6 pieces

> Acc. to DIN 7283  
> In blue plastic wallet

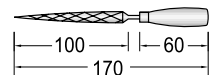

5 types	Cut	⚖️	Code	No.
■ ▲ ● ◐ ■	2	0.150	6771910	8728

### 8719 TRIANGULAR FILE

> PVC handle  
> DIN 7261, Form C  
> Cut: 2  
\* not standardised



L	L"	W	Cut	⚖️	Code	No.
150	6	*	2	0.081	6769260	8719 2-6
200	8	14	2	0.177	6769340	8719 2-8
250	10	17	2	0.304	6769420	8719 2-10

### 8725 HALF-ROUND BLUNT FILE

> PVC handle  
> DIN 7261, Form E  
> Cut: 2



L	L"	W	H	Cut	⚖️	Code	No.
150	6	16	4.5	2	0.091	6770350	8725 2-6
200	8	20	6.0	2	0.170	6770430	8725 2-8
250	10	25	7.0	2	0.285	6770510	8725 2-10

## various

644 - 646  
WIRE BRUSH

- > With untreated wooden handle, angled pattern, smooth, cast steel wire bristles



Execution	Bristle length	↳ mm ↳	⚖️	Code	No.
<b>3-row</b>	23	290	0.137	6531600	644
<b>6-row</b>	25	290	0.156	6531870	646

645  
FILE BRUSH

- > With carded cover and wooden handle
- > Bristle field 110 x 40 mm



↳ mm ↳	Bristle length	⚖️	Code	No.
<b>250</b>	10	0.095	6531790	645

## Saws

401  
SMALL SAW FOR METAL

- > Mini-hacksaw, bright nickel-plated
- > Saw blade 401 A



Description	↳ mm ↳	↳ inch ↳	⚖️	Code	No.
<b>Small saw for metal</b>	350	13.3/4	0.226	6500050	401
<b>Saw blade</b>	200		0.012	5500000	401 A

403  
HACKSAW

- > Adjustable tubular steel frame
- > For 10" and 12" hacksaw blades, complete with No. 403 A-405 A
- > Saw blades single-sided (403 A-405 A) and double-sided (403 B-405 B)
- > Handle enamelled



Description	↳ mm ↳	↳ inch ↳	⚖️	Code	No.
<b>Hacksaw</b>	410	18.1/2	0.411	6500210	403
<b>Saw blade, single-sided</b>			0.028	5500350	403 A-405 A
<b>Saw blade, double-sided</b>			0.041	5500430	403 B-405 B

404  
SMALL SAW FOR METAL PUK

- > Bright nickel-plated
- > Saw blade 404 A-406 A



Description	↳ mm ↳	↳ inch ↳	⚖️	Code	No.
<b>Small saw for metal PUK</b>	290	11	0.107	6500480	404
<b>Saw blade</b>	145		0.003	5501080	404 A-406 A

406  
HOBBY SAW

- > For wood and metal
- > Made from flat bar, 10 x 5 mm, zinc-plated
- > Glass-fibre reinforced plastic handle
- > Reach 50 mm
- > For use with junior hacksaw blades 145 mm
- > Saw blade 404 A-406 A



Description	↳ mm ↳	↳ inch ↳	⚖️	Code	No.
<b>Hobby saw</b>	250	10	0.168	6501020	406
<b>Saw blade</b>	145		0.003	5501080	404 A-406 A

407  
HACKSAW

- > Very light hacksaw in pressure-cast aluminium
- > Ergonomic soft rubber hand grips
- > Fixing of the sawblade by simple turning the blue clamping element in the hand grip
- > Clamping piece adjustable by 40°
- > Saw blade bimetal 407 A



Description	⚖️	Code	No.
<b>Hacksaw</b>	0.650	1879375	407
<b>Saw blade bimetal</b>	0.055	1879383	407 A

V 406

&gt; 595



## Parallel Vices

### 409 - 410 PARALLEL VICE

- > Welded, compact design
- > Jaws and anvil plate induction hardened
- > Extra large anvil surface for aligning works
- > Protected vice spindle
- > Adjustable guidance
- > Enamelled blue



mm	mm	kg	Code	No.
100	120	7.0	6500800	409
150	155	16.4	6500990	410

### 411 PARALLEL VICE

- > Sturdy forged design
- > Jaws and anvil plate induction hardened
- > Protected vice spindle
- > Adjustable guidance
- > Enamelled blue



mm	mm	kg	Code	No.
125	150	12.5	6501100	411-125
150	200	18.5	6501290	411-150

### E-411 SPARE JAWS FOR PARALLEL VICE

- > Jaws induction hardened



Description	mm	kg	Code	No.
Aluminium jaws 125 mm	125	0.186	5704430	E-411 A-125
Aluminium jaws 150 mm	150	0.218	5704510	E-411 A-150
Pipe-clamping jaws 125 mm	125	0.794	5704270	E-411 R-125
Pipe-clamping jaws 150 mm	150	0.778	5704350	E-411 R-150

## Measuring Tools

### 702 FEELER GAUGE SET, FAN PATTERN

- > With protective handle, folding, blade length 100 mm
- > Handle nickel-plated
- > 702 22 A + 702 26 A each increasing by 1/1000"



mm	kg	Code	No.
5 10 15 20 25 30 40 50/100	0.037	6547520	702 8 M
3 4 5 6 7 8 9 10/100	0.027	6547600	702 88 M
5 10 15 20 25 30 40 50 60 70 80 90 100/100	0.065	6547790	702 13 M
5 10 15 20 25 30 35 40 45 50 55	0.100	6547870	702 20 M
60 65 70 75 80 85 90 95 100/100			
10 12 14 16 18 20 22 24 26 28 30	0.068	6547950	702 21 M
32 34 36 38 40 42 44 46 48 50/100			

mm	kg	Code	No.
.002 .004 .006 .008 .010 .012 .015 .020"	0.033	6548250	702 8 A
.0015 .002 .003 .004 .006 .008 .010 .012 .015 .020 .025"	0.038	6548410	702 11 A
.002 .003 .004 .005 .006 .008 .010 .012 .015 .020 .025 .030 .035"	0.055	6548680	702 13 A
.004 - .025"	0.081	6548760	702 22 A
.0015 - .025"	0.080	6548840	702 26 A

## 703 M VALVE FEELER GAUGE

- > 7 Blades, blade length 75 mm



mm	kg	Code	No.
10 15 20 25 30 35 40/100	0.011	6549140	703 M

## 705 M SPARK PLUG GAUGE

- > With electrode adjuster
- > Gauge wires in precision steel wire



mm	kg	Code	No.
40 50 60 70 75 80 90 100/100 mm	0.027	6549570	705 M

## 706 THREAD GAUGE

- > 52 Blades
- > For metric and Whitworth threads
- > Pitches 0.25-6.00 mm / 62-4 Step" W



Pitch	kg	Code	No.
0,25-6,00	0.083	6549730	706

## 710 POCKET VERNIER CALLIPER

- > DIN 862, Form A 2
- > For internal and external measurements, with polished tips, depth gauge and high-speed setting
- > Graduated in mm and inches, vernier 1/20 and 1/128"
- > In leather wallet



mm	mm	inch	kg	Code	No.
213	140	5.1/2	0.171	6555030	710

## 711 DIGITAL MEASURING CALLIPER

- > To DIN 862
- > Stainless steel, hardened
- > Switchable from mm to inch
- > Measuring range 0 - 150 mm/6"
- > Data output (mini-USB)
- > Zeroing in any position
- > Measurement beak finely smoothed and lapped
- > Large LCD display (digit height 9 mm)
- > Can be used with or without thumb roller (replacement part without thumb roller included in delivery for self-mounting)
- > In sturdy protective case

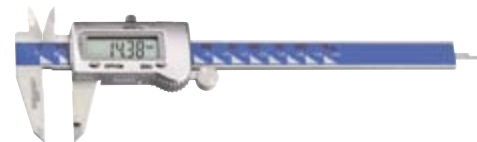

mm	mm	inch	kg	Code	No.
230	153	6	0.408	6550070	711

## 717 STEEL RULE

- > Steel rule with millimetre and inch graduation acc. to DIN ISO 2768
- > Top edge 1/64; 1/32 and 1/16 inch graduation, bottom edge 1/2 mm and 1/1 mm graduation
- > Etched graduation for a legible reading
- > Reading from left to right
- > Flexible version
- > Stainless spring-steel
- > Satin non-glare finish
- > Dimensions: 300 x 18 x 0.5 mm



mm	inch	kg	Code	No.
300	12	0.010	1965603	717-30

## 718 INSPECTION MIRROR

- > For inspection of areas that are not directly visible
- > Mirror of resistant mineral glass, Ø 30 mm, swivels through 360°
- > Telescope handle adjusts from 130 to 670 mm
- > Brass handle, mirror frame from stainless steel
- > Nickel-plated
- > Resistant to oil, grease and brake fluid



Ø	mm	kg	Code	No.
30	130-670	0.040	1979841	718

## 720 TWEEZERS

- > With angled tips
- > Bright nickel-plated



l mm	kg	Code	No.
150	0.025	6556270	720

## 721 CROSS TWEEZERS

- > With straight tips
- > Bright nickel-plated



l mm	kg	Code	No.
160	0.033	6556350	721

## 722-1 PRECISION TWEEZERS

- > Flat, fine, long points
- > Satin non-glare finish



l mm	kg	Code	No.
130	0.022	1881655	722-1

## 722-1 ESD PRECISION TWEEZERS ESD

- > Flat, fine, long points
- > Satin non-glare finish
- > ESD = electrostatic discharge protection, black



l mm	kg	Code	No.
130	0.022	1881663	722-1 ESD

## 722-2 PRECISION TWEEZERS

- > Flat, fine points
- > Satin non-glare finish



l mm	kg	Code	No.
95	0.010	1881671	722-2

## 745 SCRIBER

- > Made from special steel



l mm	kg	Code	No.
250	0.058	6559530	745

## 746 CARBIDE SCRIBER

- > Carbide, silver
- > With drop mechanics
- > Replaceable tip (E-746)



l mm	kg	Code	No.
140	0.022	6559610	746

## 4533-2 FOLDING RULE

- > Robust 2 m model with brass protective caps
- > Most suitable for craftsmen or do-it-yourselfers
- > Links 3.0 x 16 mm
- > Made of branch free beechwood with invisible metal fittings
- > Riveted joint guarantees correct measurement even in humid or dry conditions
- > With easy to read metric dual scale
- > Accuracy class III
- > EG-design approval for continuous mm division



## 4534 STEEL TAPE MEASURE

- > With belt clip and rewind stop
- > mm-divisions
- > Approved standard mark



L m	mm	kg	Code	No.
3	13	0.128	6697920	4534-3
5	19	0.220	6698060	4534-5
8	25	0.365	6698140	4534-8

L m	kg	Code	No.
2	0.086	1837087	4533-2



## Thread Workings

# 8552-025 SCREW EXTRACTOR SET

25 pieces

- > For extracting broken screws and bolts with threads M5 - M16
- > In handy plastic case, with twist drills, guide sleeves, extractor pins and extractor nuts
- > Dimensions: 200 x 120 x 38 mm



Contents		Code	No.
<b>Extractor pins size 1 2 3 4 5</b>	0.790	6755550	8552-025
<b>Drilling sleeves 1 2 3 4 5 6 7 8 9 10</b>			
<b>Extractor nuts size 10 11 13 14 17</b>			
<b>Drills 8.7-11/32" 8-5/16" 6.4-1/4" 4.8-3/16" 3.2-1/8"</b>			

# 140 THREAD FILE

- > For repairing damaged internal and external threads
- > Chrome-vanadium steel, ISO-nickel-plated
- > 140 metric threads
- > 140 A inch threads
- > 140 W Whitworth threads



for thread pitches			Code	No.
<b>0.80 1.00 1.25 1.50 2.00 2.50 3.00 mm</b>	230	0.125	6409640	140
<b>24 20 18 16 14 13 12 11 inch</b>	230	0.125	6409720	140 A
<b>24 20 18 16 14 12 11 10 Whitworth</b>	230	0.124	6409800	140 W

# 8551 S SCREW EXTRACTOR

- > For removing broken screws, bolts and tube ends
- > Made from high-grade chrome-vanadium steel, tempered, 54-56 HRC
- > Lower unscrewing torques thanks to the revised cross-section geometry
- > Reduced drilling depth thanks to an optimised thread length
- > Greater safety for user and component alike
- > Larger application range, time-saving



		Ø	Bore mm			Code	No.
<b>M3 - M6</b>	1/8-1/4	1,8-7,0	1,8	2.7	50	0.003 2659352	8551 S 1
<b>M6 - M8</b>	1/4-5/16	3,2-10,0	3,2	3.8	57	0.007 2659379	8551 S 2
<b>M8 - M11</b>	5/16-7/16	4,5-13,0	4,5	4.9	64	0.014 2659387	8551 S 3
<b>M11 - M14</b>	7/16-9/16	6,5-16,0	6,5	7.0	71	0.027 2659395	8551 S 4
<b>M14 - M18</b>	9/16-3/4	8,5-21,0	8,5	9.0	79	0.046 2659409	8551 S 5
<b>M18 - M24</b>	3/4-1	12,0	12,0	12.0	85	0.095 2659417	8551 S 6

# 8551 S BOLT EXTRACTOR SET

- > For removing broken screws, bolts and tube ends
- > Made from high-grade chrome-vanadium steel, tempered, 54-56 HRC



8551 S-006



8551 S-005

Contents			Code	No.
<b>8551 S 1 2 3 4 5</b>	M3-M18	0.125	2659336	8551 S-005
<b>8551 S 1 2 3 4 5 6</b>	M3-M24	0.230	2659344	8551 S-006

# 8551 BOLT EXTRACTOR SET

- > Made from chrome-vanadium steel, 54 HRC
- > In transparent plastic box



8551-55

Contents			Code	No.
<b>8551 1 2 3 4 5</b>	M3-M18	0.117	6759620	8551-55
<b>8551 1 2 3 4 5 6</b>	M3-M24	0.221	6759700	8551-66
<b>8551 1 2 3 4 5 6 7 8</b>	M3-M45	0.724	6759890	8551-88

## 8551 BOLT EXTRACTOR

> Made from chrome-vanadium steel, 54 HRC

### Operation:

- > Drill a central hole into the broken bolt (see table)
- > Turn the bolt extractor to the left into this hole until it grips and removes the bolt (penetrating oil may be necessary!)
- > Always choose the largest possible extractor size



$\frac{M}{mm}$	$\frac{M}{mm}$	$\emptyset$	Bore mm	$\leftarrow mm \rightarrow$	$\frac{kg}{mm^2}$	Code	No.
<b>M3 - M6</b>	1/8-1/4	1,4-3,6	1,8	2,7	50	0.005 6758490	8551 1
<b>M6 - M8</b>	1/4-5/16	2,1-4,9	2,6	3,8	57	0.009 6758570	8551 2
<b>M8 - M11</b>	5/16-7/16	3,1-5,5	3,7	4,9	65	0.015 6758650	8551 3
<b>M11 - M14</b>	7/16-9/16	4,8-8,8	5,5	7,0	70	0.030 6758730	8551 4
<b>M14 - M18</b>	9/16-3/4	6,2-11,0	7,0	9,0	80	0.051 6758810	8551 5
<b>M18 - M24</b>	3/4-1	9,4-15,0	10,3	12,0	85	0.098 6759030	8551 6
<b>M24 - M33</b>	1-1.3/8	12,7-19,0	13,7	14,5	95	0.162 6759110	8551 7
<b>M33 - M45</b>	1.3/8-1.3/4	17,5-24,0	18,6	18,0	100	0.283 6759380	8551 8

## 8551 TG TAP WRENCH WITH RATCHET

> To operate bolt extractors (no. 8551 and 8551 S) in confined spaces

- > Reversible for clockwise or counterclockwise operation
- > Sliding T-handle
- > With two-jaw chuck to hold square shanks
- > All steel version, chrome-plated

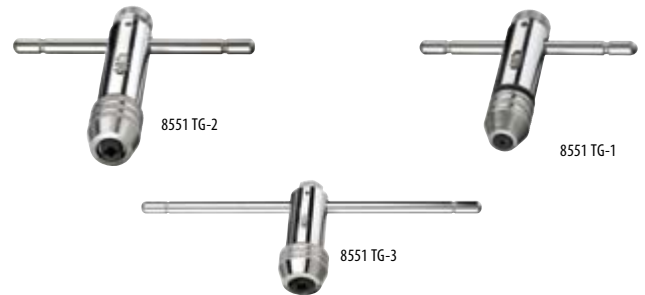

$\frac{mm}{mm}$	$\frac{M}{mm}$	$\leftarrow mm \rightarrow$	$\frac{kg}{mm^2}$	Code	No.
<b>2,0-5,0</b>	M3-M8	85	0.186	2659433	8551 TG-1
<b>4,6-8,0</b>	M5-M12	110	0.315	2659441	8551 TG-2
<b>9,0-12,5</b>	M13-M20	117	1.040	2659468	8551 TG-3

## 8553 TAP AND DIE SET

- > In plastic case
- > Dimensions: 275 x 150 x 42 mm
- > For internal threads M3 - M6
- > For external threads M3 - M6, max. 40 mm long
- > Ratchet drive system with extension unit
- > Additional guide sleeve for dies to ensure accurately aligned thread cutting along the bar axis, with swarf collector
- > **Drives:** Ratchet with extension
- > **Taps:** Quick-clamp tap wrench with M3-M6 taps
- > **Dies:** Die handle with guide disc and M3-M6 dies
- > **Accessories:** Fixing screws and angle screwdriver



Contents	$\frac{kg}{mm^2}$	Code	No.
T-handle ratchet 2093 U-3 T	0.510	1939068	8553
Hex socket key 2 mm			
Extension, 1/4" 4 mm			
Die holder			
Quick-clamp tap wrench			
Threaded stud M4x6			
Backing washer			
Guide disc M3 M4 M5 M6			
Dies M3 M4 M5 M6			
Taps M3 M4 M5 M6			

## Scrapers

### 130 THREE-EDGED BEARING SCRAPER

- > Made from special steel
- > Working ends polished
- > With wooden handle
- > Flanged blade



Spoon				Code	No.
70	150	270	0.136	8777350	130-150
85	200	315	0.171	8777430	130-200

### 132 THREE-EDGED HOLLOW GROUND SCRAPER

- > Made from special steel
- > Working ends polished
- > With wooden handle
- > Flanged blade



			Code	No.
150	270	0.100	8779130	132-150
200	315	0.163	8779480	132-200
250	365	0.185	8779560	132-250

## SAFETY INSTRUCTION FOR SCRAPERS



- > Do not touch the sharp working edges.

### 133 D GASKET SCRAPER

- > Made from special steel
- > With wooden handle
- > Flanged blade



			Code	No.
150	260	0.120	1395262	133 D-150

### 134 THREE-EDGED FLAT GROUND SCRAPER

- > Made from special steel
- > Working ends polished
- > With wooden handle
- > Flanged blade



			Code	No.
100	200	0.072	8781620	134-100
150	270	0.139	8781890	134-150
200	315	0.168	8782000	134-200

### 131 CURVED BEARING SCRAPER (LONG SCRAPER)

American pattern

- > Made from special steel
- > Working ends polished
- > With wooden handle

- > Flanged blade



Spoon				Code	No.
85	200	315	0.100	8778320	131-200

### 133 F FLAT SCRAPER

- > Made from special steel
- > Working ends polished
- > With wooden handle

- > Flanged blade
- > \* not standardised



					Code	No.
150	270	20	5	*	0.190	8780490 133 F-150
200	315	20	5		0.234	8780650 133 F-200
250	365	25	6		0.390	8780730 133 F-250

### 133 H HARD METAL TIP FLAT SCRAPER

- > Soldered hard metal tip
- > Wooden handle



					Code	No.
30	5	250	365	0.350	4523000	133 H

### 133 K GASKET SCRAPER

- > With plastic handle



				Code	No.
10	240	22.5	0.154	6535190	133 K

### 134 K THREE-SQUARE SCRAPER

- > With ground edges
- > Shaft PVC coated
- > Black plastic handle



				Code	No.
6	80	170	0.060	4646860	134 K

## Arc punches

5700  
ARC PUNCH

- > To DIN 7200 Form A
- > For stamping out cardboard, leather, rubber, sealing materials and other soft materials
- > Cutting edge hardened
- > Shaft blue varnished

Ø mm	Ø inch	l mm	W kg	Code	No.
2	1/16	105	0.045	4542300	570002
3	1/8	105	0.045	4542490	570003
4	5/32	105	0.050	4542570	570004
5	3/16	110	0.070	4542650	570005
6	1/4	110	0.070	4542730	570006
7		120	0.090	4542810	570007
8	5/16	120	0.090	4543030	570008
9	11/32	120	0.090	4543110	570009
10	3/8	130	0.125	4543380	570010
11	7/16	130	0.130	4543460	570011
12	15/32	130	0.130	4543540	570012
13	1/2	140	0.165	4543620	570013
14	9/16	140	0.170	4626590	570014
15	19/32	140	0.180	4543890	570015
16	5/8	140	0.180	4543970	570016
17	21/32	145	0.230	4544000	570017
18	11/16	145	0.230	4544190	570018
19	3/4	145	0.240	4544270	570019
20	25/32	160	0.315	4544350	570020
21	13/16	160	0.315	4546560	570021

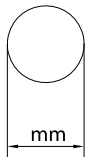

Ø mm	Ø inch	l mm	W kg	Code	No.
22	7/8	160	0.320	4545670	570022
23	29/32	170	0.375	4545750	570023
24	15/16	170	0.375	4540440	570024
25	1	170	0.400	4618300	570025
26	1.1/32	170	0.375	4618490	570026
27	1.1/16	175	0.475	4618570	570027
28	1.3/32	175	0.500	4618650	570028
29	1.1/8	175	0.450	4618730	570029
30	1.3/16	190	0.590	4618810	570030
31		190	0.580	4619030	570031
32	1.1/4	190	0.580	4619110	570032
33		195	0.660	4619380	570033
34	1.5/16	195	0.675	4619460	570034
35	1.3/8	195	0.690	4619540	570035
36		200	0.700	4619620	570036
37	1.7/16	205	0.700	4619700	570037
38	1.1/2	205	0.770	4619890	570038
39		205	0.770	4619970	570039
40	1.9/16	205	0.860	4620040	570040

5703  
SET OF ARC PUNCHES

- > To DIN 7200 Form A
- > For stamping out cardboard, leather, rubber, sealing materials and other soft materials
- > Cutting edge hardened
- > Shaft blue varnished
- > In plastic wallet no. 570390



Contents	W kg	Code	No.
<b>10 pieces, consisting of 1 piece each</b> <b>Arc punch 3, 5, 7, 8, 10, 13, 16, 19, 22 and 25 mm</b>	1.850	1549502	570303
<b>8 pieces, consisting of 1 piece each</b> <b>Arc punch 3, 6, 8, 10, 12, 16, 20 and 25 mm</b>	1.470	1549510	570304
<b>7 pieces, consisting of 1 piece each</b> <b>4, 6, 8, 10, 12, 14, 16 mm</b>	0.960	2646382	570307

1101-5705  
SET OF ARC PUNCHES

in i-BOXX® 72

- > To DIN 7200 Form A
- > For stamping out cardboard, leather, rubber, sealing materials and other soft materials
- > Cutting edge hardened
- > Shaft blue varnished
- > Delivery in GEDORE i-BOXX® 72 no. 1101 L
- > Dimensions: W 367 x D 316 x H 72 mm



Contents	W kg	Code	No.
<b>18 pieces, consisting of 1 piece each</b> <b>Arc punch 2, 3, 4, 5, 6, 7, 8, 9,</b> <b>10, 11, 12, 13, 14, 15, 16, 18, 20, 22 mm</b> <b>1 GEDORE i-BOXX® 72 no. 1101 L</b>	3.395	2963469	1101-570500

## Tin snips

### 420 TIN SNIPS

- > Right hand cutting
- > For long straight cuts
- > Berlin pattern
- > Ground cutting edges
- > Sheet thickness max. 1.0 mm at strength 600 N/mm<sup>2</sup>
- > Black varnished, handles blue epoxy coated



Execution	l mm	kg	Code	No.
right hand cutting	250	0.470	4513980	420025
right hand cutting	300	0.740	4514010	420030

### 421 HOLE CUTTING SNIPS

- > For short straight and figure cuts (great radii)
- > Polished cutting edges
- > Sheet thickness max. 1.0 mm at strength 600 N/mm<sup>2</sup>
- > Black varnished, handles blue epoxy coated



Execution	l mm	kg	Code	No.
right hand cutting	250	0.490	4514280	421025
right hand cutting	275	0.520	4514360	421027

### 422 IDEAL PATTERN SNIPS

- > For straight continuous and figure cuts
- > Polished cutting edges
- > Sheet thickness max. 1.0 mm at strength 600 N/mm<sup>2</sup>
- > Black varnished, handles blue epoxy coated



Execution	l mm	kg	Code	No.
right hand cutting	260	0.510	4514870	422026
left hand cutting	260	0.565	4515090	422126

### 423 PELICAN PATTERN SNIPS

- > Right hand cutting
- > For long straight continuous and figure cuts
- > Polished cutting edges
- > Sheet thickness max. 1.0 mm at strength 600 N/mm<sup>2</sup>
- > Black varnished, handles blue epoxy coated



Execution	l mm	kg	Code	No.
right hand cutting	300	0.730	4515250	423030
right hand cutting	350	0.850	4515330	423035

### 424 IDEAL PATTERN SNIPS

- > For straight continuous and figure cuts
- > With lever action
- > Self-opening with installed spring, with lock
- > Polished cutting edges
- > Sheet thickness max. 1.2 mm at strength 600 N/mm<sup>2</sup>
- > Non-slip 2-component handles



Execution	l mm	kg	Code	No.
right hand cutting	260	0.530	4515410	424026
left hand cutting	260	0.530	4515680	424126

### 425 FIGURE SNIPS

- > For straight continuous and figure cuts
- > With lever action
- > Self-opening with installed spring, with lock
- > Polished cutting edges
- > Sheet thickness max. 1.2 mm at strength 600 N/mm<sup>2</sup>
- > Non-slip 2-component handles



Execution	l mm	kg	Code	No.
right hand cutting	260	0.480	4515760	425026

## Industrial Cutlery

- > Cutlery is traditionally not made from tempering steel, but from plain carbon steel. Carbon steel is not stainless, but keeps its sharpness longer than stainless steel.
- > All GEDORE scissors are hot, drop-forged.
- > Precisely machined and hardened/tempered.



- > The cutting-edge is manually ground
- > Carbon steel, professional hardening/tempering and the hand-ground cutting edge ensure an optimum cut and cutting-sharpness longevity.

## Knives

### 0038 POCKET KNIFE

- > Anchor or dinghy knife for heavy-duty use
- > Folding
- > Universal use
- > Extremely sharp
- > C75 carbon steel blade
- > Weatherproof hardwood handle





			Code	No.
80	180	0.086	9100580	0038-08

### 0042 CABLE KNIFE

- > With wire stripper
- > Folding
- > Universal use
- > Extremely sharp
- > C75 carbon steel blade
- > Weatherproof hardwood handle





			Code	No.
90	195	0.076	9100660	0042-09

### 0063 CABLE KNIFE

- > With wire stripper
- > Folding
- > Universal use
- > Extremely sharp
- > X46Cr13 stainless steel blade
- > Plastic handle





			Code	No.
80	200	0.092	9101200	0063-08

### 0059 - 0067 POCKET KNIFE

- > Traditional working knife
- > Folding
- > Universal use
- > Extremely sharp
- > C75 carbon steel blade
- > Weatherproof hardwood handle





			Code	No.
70	160	0.061	9101470	0067-07
90	185	0.078	9101390	0065-09
100	210	0.102	9101120	0059-10

### 0117 WORK KNIFE

- > Ideal as a packaging, boxing, warehousing or paper knife
- > Extremely sharp
- > C75 carbon steel blade
- > Beech handle





			Code	No.
100	220	0.070	9102520	0117-10
120	240	0.080	9102600	0117-12
160	280	0.106	9102790	0117-16
180	300	0.110	9102870	0117-18

### 0246 INDUSTRIAL KNIFE

- > Wide blade with straight back
- > Extremely sharp
- > C75 carbon steel blade
- > Beech handle



			Code	No.
160	280	0.098	9106860	0246-16

## 0291 UNIVERSAL KNIFE

- > Universal use
- > Extremely sharp
- > C75 carbon steel blade
- > Beech handle





			Code	No.
60	175	0.037	9107910	0291-06

## 0365 UNIVERSAL KNIFE

- > Stainless steel
- > Handle made from cherrywood





			Code	No.
70	165	0.039	9109290	0365-07

## 0513 CABLE KNIFE

- > With wire stripper
- > Folding
- > Universal use
- > Extremely sharp
- > C70 carbon steel blade
- > Weatherproof hardwood handle



			Code	No.
90	195	0.080	9113050	0513-09

4528

&gt; 595



VDE 4522 K

&gt; 594



VDE 4527 K

&gt; 594



## Scrapers

### 0175 SCRAPER

- > Stamped blade
- > Fine-polished, flexible C75 carbon steel
- > Glazed beech handle



W		Code	No.
50	0.072	9104060	0175-05
60	0.080	9104140	0175-06
100	0.110	9104300	0175-10

### 0179 SCRAPER

- > Professional version
- > Fully forged
- > Fine-polished, flexible C50 carbon steel
- > Weatherproof hardwood handle

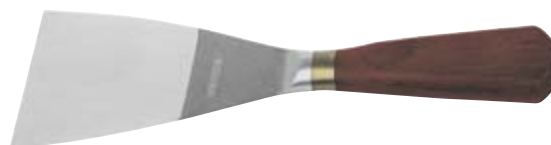

W		Code	No.
60	0.084	9104730	0179-06



## Scissors

## 1104 CRAFTSMAN SCISSORS

- > Outstanding cutting performance
- > Suitable for textiles, rubber, wallpaper, plastic, etc.
- > Forged, resharpenable
- > Adjuster screw for later adjustment
- > Fine-polished C45 carbon steel, varnished eyes, silicone dipped RAL 5015
- > Chrome-plated
- > Version L = for left-handers



Size	Length of cutting edge	Total length		Code	No.
7"	85	180	0.142	9118280	1104-18
8"	95	200	0.248	9118360	1104-20
9"	110	230	0.300	9118440	1104-23
10"	120	260	0.378	9118520	1104-26

## 1277 INDUSTRIAL SCISSORS PROFESSIONAL

- > With two equal eyes
- > For universal use
- > Hand-ground
- > Adjuster screw for later adjustment
- > Fine-polished C45 carbon steel
- > Chrome-plated



Size	Length of cutting edge	Total length		Code	No.
6"	65	160	0.061	9119840	1277-16
7"	80	180	0.088	9119920	1277-18

## 1350 INDUSTRIAL SCISSORS PROFESSIONAL

- > One large and one small eye for higher transmission of force
- > For universal use
- > Hand-ground
- > Adjuster screw for later adjustment
- > Fine-polished carbon steel
- > Chrome-plated
- > Version L = for left-handers



Size	Length of cutting edge	Total length		Code	No.
6"	65	160	0.070	9120770	1350-16
7"	80	180	0.094	9120850	1350-18
7"	80	180	0.094	2082314	1350-18L
8"	100	200	0.132	9120930	1350-20

## 8096 SMALL UNIVERSAL SCISSORS

- > With insulation stripping slot
- > Nickel-plated, with blue handle protectors

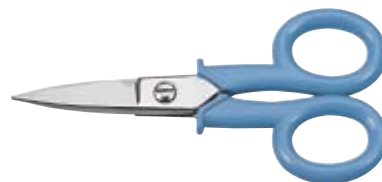

Length of cutting edge	Total length		Code	No.
50	140	0.075	6707900	8096-140

## Safety at work

### Work gloves

#### 920 WORK GLOVES FASTFIT

- > For universal use
- > Close fitting for retention of feel and dexterity
- > Stage 5 classification as per EN 420/03 (scale from 0 - 5)
- > Kind on the skin
- > Rugged imitation leather and synthetic material



Size		Code	No.
<b>S/8</b>	0.070	1938576	920 8
<b>M/9</b>	0.070	1938584	920 9
<b>L/10</b>	0.080	1938592	920 10
<b>XL/11</b>	0.080	1938606	920 11
<b>XXL/12</b>	0.080	1938614	920 12

#### 922 WORK GLOVES M-PACT

- > For heavy duty use
- > Close fitting for retention of feel and dexterity
- > Stage 5 classification as per EN 420/03 (scale from 0 - 5)
- > Rubber reinforced finger tips
- > Adjustable Velcro fasteners on the cuffs
- > Additional knuckle protectors
- > Ergonomic palm reinforcement
- > Rugged imitation leather and synthetic material



Size		Code	No.
<b>S/8</b>	0.080	1938738	922 8
<b>M/9</b>	0.080	1938746	922 9
<b>L/10</b>	0.080	1938754	922 10
<b>XL/11</b>	0.090	1938762	922 11
<b>XXL/12</b>	0.090	1938770	922 12

### Tool Bags

#### WT 1056 1 HEAVY-DUTY BELT WITH CUSHION

- > Fits waist size from 80-120 cm (32"-48")
- > Strongly cushioned for maximum comfort
- > Made from leather



L	W	max. load capacity kg		Code	No.
<b>1330</b>	145	12	0.450	1802410	WT 1056 1

#### WT 1056 2 UNIVERSAL POUCH

- > Leather pocket for knives
- > Hammer holder with metal hooks
- > Hook for tape measure



W	H	max. load capacity kg		Code	No.
<b>290</b>	290	5	0.340	1811096	WT 1056 2

#### WT 1056 3 DRILL HOLSTER

- > Suitable for drill-machines and battery-drills
- > With pockets for screws and bits
- > Securing loop as loss-proof



W	H	max. load capacity kg		Code	No.
<b>210</b>	320	4	0.150	1818147	WT 1056 3

#### WT 1056 4 HAMMER HOLDER WITH METAL HOOKS

- > Holds any claw hammer at a comfortable angle
- > Enables boundless freedom of movement
- > Polyester and blue suede
- > Stainless tab



W	H	max. load capacity kg		Code	No.
<b>100</b>	160	3	0.100	1818155	WT 1056 4

## WT 1056 5 THREE-POUCH BELT SET

- > Fits waist size from 80-120 cm (32"-48")
- > 4 holsters, 5 storage pockets and 1 eyelet for tape measure



W	H	max. load capacity kg		Code	No.
690	270	10	0.750	1818163	WT 1056 5

## WT 1056 6 ELECTRICIANS' POUCH

- > Generous pouch space
- > 8 pockets for screwdrivers
- > Extra pocket for insulation stripping knife
- > Holding shackle for insulating tape





W	H	max. load capacity kg		Code	No.
240	320	3	0.500	1818171	WT 1056 6

## WT 1056 7 HEAVY-DUTY BELT SET

- > Heavily padded belt for superior comfort when fully loaded
- > Fits waist size from 80-120 cm (32"-48")
- > Basic belt from leather
- > All inclusive: Holster, hammer holder, 2 pockets and mobile phone holder (available separately WT 1056 7-1)



Description		max. load capacity kg		Code	No.
<b>Heavy-duty belt set</b>	1330	12	1.600	1818198	WT 1056 7
<b>Mobile phone holder</b>	-	-	0.052	1963171	WT 1056 7-1

## WT 1056 8 DUO POUCH

- > Leather pocket for knives
- > 2 large storage pockets



W	H	max. load capacity kg		Code	No.
240	280	3	0.360	1818201	WT 1056 8

## WT 1056 9 ROLL-COVER

- > With 12 inside pockets for slim tools, e.g. combination spanners or screwdrivers
- > Delivery without tools



W	H	max. load capacity kg		Code	No.
320	350	2	0.120	1818228	WT 1056 9

## WT 1056 10

### KNEE PADS, PAIR

- > Made of strong synthetic leather with rubber
- > Soft lining for comfortable kneeling
- > Hook and loop fastener
- > Universal size



kg	Code	No.
0.200	1818236	WT 1056 10

## WT 1056 11

### TOOL RUCKSACK PROFI

- > With extra large capacities
- > Practical and ergonomic arrangement of the internal and external pockets
- > Ideal for transport and storage of tools, accessories and documents
- > Strong zippers
- > Reinforced back, padded adjustable shoulder straps and additional practical handle on the top
- > Tear-resistant polyester fabric with 3M reflective stripes, suede
- > Spray-water repellent, resistant to chemical agents
- > Inured to temperature changes



W	H	D	max. load capacity kg	kg	Code	No.
300	400	120	15	2.800	1818244	WT 1056 11

## WT 1056 12

### TOOL RUCKSACK SOFT

- > SOFT rucksack, extremely light and yet strong
- > Tear-resistant polyester fabric and suede
- > Strong and watertight
- > Practical and ergonomic arrangement of the internal and external pockets
- > Ideal for transport and storage of tools, accessories and documents
- > Strong zippers
- > Padded adjustable shoulder straps and additional practical handle on the top



W	H	D	max. load capacity kg	kg	Code	No.
380	410	70	12	1.900	1818252	WT 1056 12

## WT 1056 13

### TOOL VEST

- > Multifunctional tool vest with many pockets and holsters
- > Universal size with 4 lateral buckles
- > Padded pouches of different dimensions for tools and small components
- > Mobile phone holder and reinforced tab to hang a hammer
- > Wide back pouch
- > Net insert in the back for a better transpiration
- > Compartment with window for an identity card
- > Tear-resistant polyester fabric with 3M reflective stripes, suede
- > Spray-water repellent, resistant to chemical agents
- > Inured to temperature changes



W	H	max. load capacity kg	kg	Code	No.
480	660	5	1.000	1818260	WT 1056 13



---

# VDE INSULATED SAFETY TOOLS

---

## VDE SPANNERS

>572



---

## VDE TORQUE WRENCHES

>573



---

## SOCKETS + ACCESSORIES 3/8"

1000 V

>573



---

## SOCKETS + ACCESSORIES 1/2"

1000 V

>574



---

## VDE SCREWDRIVER

>575



---

## VDE PLIERS

>580



---

## VDE ASSORTMENTS

>587



---

## VDE ACCESSORIES

>593



# VDE INSULATED SAFETY TOOLS

## Note:

- > Texts: All DIN EN 60900-tested tools must be marked with the manufacturer's name, model or type designation, the year of manufacture and the double triangle lightning symbol with the 1000 V detail.
- > All mechanical requirements such as hardness, torque and forces must comply with the DIN-ISO tolerances.



Is the work environment well prepared?

### VDE accessories

Some items in our VDE accessories range are marked with the usual test mark for protective equipment.



## What should I consider before starting work?

The VDE safety check - for your own safety

### Safety Notes

- > Work on electrically live equipment must be carried out only by trained electricians!
- > Only tools and safety equipment marked with the double triangle or bell 1000 V symbol (refer to BGV A3) must be used.
- > Before commencing any work, check the insulation for damage.
- > Damaged tools must not be used!
- > The regulations of the employers' liability insurance associations and power supply companies must be complied with!
- > GEDORE VDE tools are approved for work on live circuits at voltages up to 1000 V AC and 1500 V DC.
- > Tools must not be combined unless they are designed to be securely joined together.





- > Only tools bearing this test mark are classed as insulated tools
- > VDE insulation: insulated up to 1000 V acc. to EN 60900/IEC 60900
- > Safe working in high-voltage areas
- > Up to 1000 V AC (alternating current)
- > Up to 1500 V DC (direct current)



Tools marked with the double triangle are individually tested = testing at 10,000 V AC based on EN 60900/IEC 60900



The VDE symbol points to the VDE Test Institute as having carried out the test. As a result, GEDORE and the VDE Test Institute vouch for the fulfilment of the tool and safety standards and thus meet the requirements of the German equipment safety law.



The GS symbol is a symbol defined in the law on technical equipment and consumer products (German Equipment and Product Safety Act/GSPG). It may only be used with the name given of the testing and certification office.

## VDE Check-Tool Insulation

- > All GEDORE VDE soft-plastic insulated safety tools have the Check-Tool insulation.
- > The two-colour multi-layer insulation - red on the outside, yellow on the inside - complies with the BGV A3 (VBG-4) regulation.
- > The tool must not show any discernable damage. If yellow is visible, it is high time to dispose of the tool.
- > For technical reasons, Check-Tool insulation cannot be applied on tools with sprayed insulation.



The two-ply Check-Tool insulation



## VDE 2 E VDE SINGLE ENDED RING SPANNER



deep offset

- > GEDORE vanadium steel 31CrV3
- > VDE insulation up to 1000 V, acc. to EN 60900/IEC 60900, two-ply Check-Tool insulation



VDE 2 E 19



VDE 2 E 13

Ø	l mm	kg	Code	No.
8	170	0.061	6035890	VDE 2 E 8
9	170	0.074	6035970	VDE 2 E 9
10	170	0.097	6036000	VDE 2 E 10
11	180	0.093	6036190	VDE 2 E 11
12	190	0.147	6036270	VDE 2 E 12
13	190	0.130	6036350	VDE 2 E 13
14	210	0.151	6036430	VDE 2 E 14
15	215	0.155	6036510	VDE 2 E 15
17	220	0.199	6036780	VDE 2 E 17
19	240	0.244	6036860	VDE 2 E 19
22	260	0.319	6036940	VDE 2 E 22
24	280	0.446	6037080	VDE 2 E 24
27	295	0.506	6037160	VDE 2 E 27
30	310	0.592	6037240	VDE 2 E 30
32	330	0.683	6037320	VDE 2 E 32

## VDE 894 VDE SINGLE OPEN ENDED SPANNER



- > GEDORE vanadium steel 31CrV3
- > VDE insulation up to 1000 V, acc. to EN 60900/IEC 60900, two-ply Check-Tool insulation
- > Jaw set at 15°



VDE 894 12



VDE 894 22

Ø mm	l mm	kg	Code	No.
9	105	0.030	6572040	VDE 894 9
10	105	0.034	6572120	VDE 894 10
11	115	0.044	6572200	VDE 894 11
12	125	0.052	6572390	VDE 894 12
13	135	0.067	6572470	VDE 894 13
14	145	0.081	6572550	VDE 894 14
15	150	0.093	6572630	VDE 894 15
16	155	0.108	6572710	VDE 894 16
17	160	0.117	6572980	VDE 894 17
19	175	0.161	6573010	VDE 894 19
22	200	0.210	6573280	VDE 894 22
24	220	0.268	6573360	VDE 894 24
27	245	0.396	6573440	VDE 894 27
30	265	0.486	6573520	VDE 894 30
32	280	0.558	6574920	VDE 894 32

## V 60 CP ADJUSTABLE WRENCH



open end, 1000 V

- > Chrome-plated
- > Dip-insulated
- > Individually tested, insulation up to 1000 V



Size "	mm	kg	Code	No.
6	20	0.170	2179040	V 60 CP 6
8	25	0.330	2179059	V 60 CP 8
10	30	0.520	2179067	V 60 CP 10
12	36	0.880	2179075	V 60 CP 12

## VDE 2133 VDE SOCKET WRENCH



with 3C handle

- > 3-component handles Power-Grip<sup>3</sup> with hanging hole
- > Ergonomic handle design enables precise and fatigue-free working
- > Positive-fit joint of handle and blade for optimum transmission of force
- > Head depth 25 mm, blade length 125 mm
- > VDE insulation up to 1000 V, acc. to EN 60900/IEC 60900



Ø	l mm	l mm	Head Ø	Ø	kg	Code	No.
3	125	225	9	8,9	0.109	1747045	VDE 2133 3
4	125	225	10	8,9	0.111	1747053	VDE 2133 4
5	125	225	11	8,9	0.112	1747061	VDE 2133 5
6	125	225	12	8,9	0.114	1747088	VDE 2133 6
7	125	235	14	9,9	0.152	1747096	VDE 2133 7
8	125	235	15	9,9	0.154	1747118	VDE 2133 8
9	125	235	16	9,9	0.154	1747126	VDE 2133 9
10	125	235	17	9,9	0.161	1747134	VDE 2133 10
11	125	245	19	10,9	0.193	1747142	VDE 2133 11
12	125	245	20	10,9	0.196	1747150	VDE 2133 12
13	125	245	21	10,9	0.199	1747169	VDE 2133 13
14	125	245	22	10,9	0.198	1747177	VDE 2133 14
17	125	245	26	10,9	0.222	1747185	VDE 2133 17

## VDE 4507

### VDE TORQUE WRENCH 1/2"



5-50 N·m / 4-37 lbf·ft

- > Controlled screw tightening in the most common range of 5 - 50 N·m / 4 - 37 lbf·ft
- > Automatic short-path actuation with tactile impulse and audible signal
- > Dual scale with a scale graduation of 5 N·m and 5 lbf·ft
- > Fine toothed ratchet with square drive as per DIN 3120 - A 12.5, ISO 1174
- > VDE insulation up to 1000 V, acc. to EN 60900/IEC 60900, two-ply Check-Tool insulation



"	mm	mm	kg	Code	No.
1/2	12.5	370	1.251	6681920	VDE 4507-4

## VDE INX 30

### VDE SCREWDRIVER BIT SOCKET 3/8"

NEW



for multi-point screws XZN

- > With pressed-in pin
- > With square drive according to DIN 3120 - C 12.5, ISO 1174
- > Bit in GEDORE vanadium special steel, manganese-phosphated
- > VDE insulation up to 1000 V, acc. to EN 60900/IEC 60900, two-ply Check-Tool insulation



"	Code	No.
M8	2946564	VDE INX 30 8
M10	2946572	VDE INX 30 10
M12	2946580	VDE INX 30 12

## VDE 3090

### VDE EXTENSION 3/8"

NEW



- > For hand-operated sockets with square drive as per DIN 3120, ISO 1174
- > VDE insulation up to 1000 V, acc. to EN 60900/IEC 60900, two-ply Check-Tool insulation
- > 16 - 18 mm insulation overhang



"	mm	mm	kg	Code	No.
3/8	10	75	0.097	2946548	VDE 3090-3
3/8	10	150	0.115	2946556	VDE 3090-6

## VDE 30

### VDE SOCKET 3/8"

NEW



- > Hexagon socket wrench, hand-operated
- > With square drive according to DIN 3120 - C 10, ISO 1174
- > GEDORE vanadium steel 31CrV3
- > VDE insulation up to 1000 V, acc. to EN 60900/IEC 60900, two-ply Check-Tool insulation
- > 16 - 18 mm insulation overhang

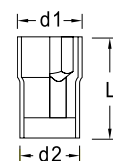

O	d <sub>1</sub>	d <sub>2</sub>	L	Code	No.
6	13.7	23	44	2946386	VDE 30 6
8	16.1	23	44	2946394	VDE 30 8
9		23	44	2946408	VDE 30 9
10	18.7	23	44	2946416	VDE 30 10
11	20.0	23	44	2946424	VDE 30 11
12	21.2	23	44	2946432	VDE 30 12
13	22.5	23	44	2946440	VDE 30 13
14	23.7	23	45	2946459	VDE 30 14
15	25.0	23	46	2946467	VDE 30 15
16	26.2	23	46	2946475	VDE 30 16
17	27.5	23	46	2946483	VDE 30 17
18	28.7	23	46	2946491	VDE 30 18
19	30.0	23	46	2946505	VDE 30 19
20	31.2	23	47	2946513	VDE 30 20
22	33.7	23	48	2946521	VDE 30 22

## VDE 3093 U

### VDE REVERSIBLE RATCHET 3/8"

NEW



with push-button release

- > Robust, with smooth action
- > Sockets held absolutely securely by push-button lock with ball in the square drive
- > Direction changed by 2 push-buttons, marked R and L, on the shaft
- > Return angle 8.2 degrees
- > Square drive acc. to DIN 3120 - A 10, ISO 1174, chrome-vanadium steel 31CrV3
- > VDE insulation up to 1000 V, acc. to EN 60900/IEC 60900



"	mm	mm	kg	Code	No.
3/8	10	185	0.215	2946599	VDE 3093 U



## VDE 19 VDE SOCKET 1/2"



- > Hexagon socket wrench, hand-operated
- > With square drive according to DIN 3120 - C 12.5, ISO 1174
- > GEDORE vanadium steel 31CrV3
- > VDE insulation up to 1000 V, acc. to EN 60900/IEC 60900, two-ply Check-Tool insulation
- > 16 - 18 mm insulation overhang
- > Sizes 27, 30 and 32: diameter  $d_1$  is not standardised

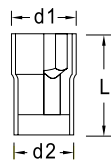

Ø	$d_1$	$d_2$	L		Code	No.
10	19.5	27	54.0	0.070	6122510	VDE 19 10
11	20.7	27	54.0	0.067	6122780	VDE 19 11
12	22.0	27	54.0	0.070	6122860	VDE 19 12
13	23.2	27	54.0	0.069	6122940	VDE 19 13
14	24.5	27	54.0	0.073	6123080	VDE 19 14
15	25.7	27	55.5	0.088	6123160	VDE 19 15
16	27.0	27	55.5	0.086	1439294	VDE 19 16
17	28.2	27	55.5	0.084	6123240	VDE 19 17
19	30.7	27	56.0	0.092	6123320	VDE 19 19
22	34.5	27	57.5	0.121	6123400	VDE 19 22
24	37.0	27	57.5	0.146	6123590	VDE 19 24
27	40.7	27	57.5	0.174	6123670	VDE 19 27
30	44.5	27	59.0	0.212	6123750	VDE 19 30
32	47.0	27	60.5	0.250	6123830	VDE 19 32

## VDE 1988 - VDE 1989 T VDE T-HANDLE



for 1/2" VDE tools

- > VDE insulation up to 1000 V, acc. to EN 60900/IEC 60900, two-ply Check-Tool insulation
- > VDE 1988 with screw locking, not suited for use with VDE IN 19
- > VDE 1989 T with pull locking

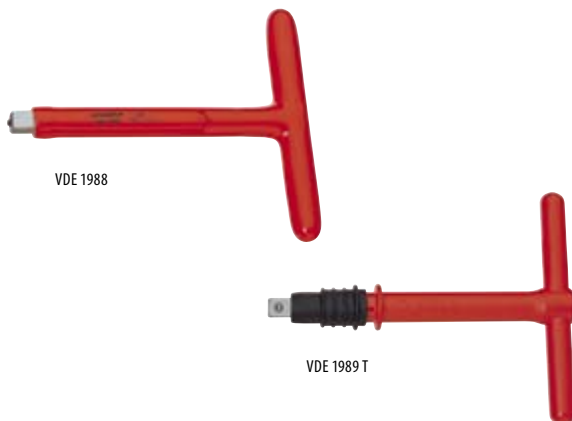

■ "	■	↳ mm ↳		Code	No.
1/2	12.5	200	0.455	6124210	VDE 1988
1/2	12.5	200	0.355	6124720	VDE 1989 T

## VDE IN 19 VDE SCREWDRIVER BIT SOCKET 1/2"



for in-hex screws

- > With pressed-in pin
- > With square drive according to DIN 3120 - C 12.5, ISO 1174, with ball groove
- > Tip GEDORE vanadium special steel
- > VDE insulation up to 1000 V, acc. to EN 60900/IEC 60900, two-ply Check-Tool insulation
- > Sockets can only be combined with VDE 1989 T, VDE 1991, VDE 1993 U and VDE 4507



●	↳ mm ↳	∅		Code	No.
5	106	27	0.083	6124480	VDE IN 19 5
6	106	27	0.095	6124560	VDE IN 19 6
8	106	27	0.109	6124640	VDE IN 19 8

## VDE 1990 VDE EXTENSION 1/2"



- > For hand-operated sockets with square drive as per DIN 3120, ISO 1174
- > With lock screw for holding the socket wrenches
- > VDE insulation up to 1000 V, acc. to EN 60900/IEC 60900, two-ply Check-Tool insulation
- > Not suited for use with VDE IN 19
- > 16 - 18 mm insulation overhang



■ "	■	↳ mm ↳		Code	No.
1/2	12.5	125	0.213	6124050	VDE 1990-5
1/2	12.5	250	0.411	6124130	VDE 1990-10

## VDE 1991 VDE EXTENSION 1/2"



- > With hollow shaft, especially suitable for screwdriver bit sockets VDE IN 19
- > Max. torque 370 N-m
- > VDE insulation up to 1000 V, acc. to EN 60900/IEC 60900, two-ply Check-Tool insulation



■ "	■	↳ mm ↳		Code	No.
1/2	12.5	125	0.204	1507516	VDE 1991

## VDE 1993 U

### VDE REVERSIBLE RATCHET

#### 1/2"



with push-button release

- > Robust, with smooth action
- > Sockets held absolutely securely by push-button lock with ball in the square drive
- > Direction changed by 2 push-buttons, marked R and L, on the shaft
- > Return angle 10 degrees
- > Square drive acc. to DIN 3120 - A 12.5, ISO 1174, chrome-vanadium steel 31CrV3
- > VDE insulation up to 1000 V, acc. to EN 60900/IEC 60900



"	mm	mm	kg	Code	No.
1/2	12.5	270	0.546	6123910	VDE 1993 U

## V 42

### VDE HEXAGON ALLEN KEY

1000 V

for in-hex screws

- > Acc. to DIN ISO 2936
- > Particularly suitable for cable branch clamping rings
- > Oil-hardened
- > GEDORE vanadium special steel
- > Individually tested, insulation up to 1000 V

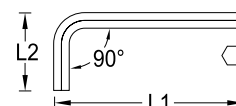

mm	L <sub>1</sub>	L <sub>2</sub>	kg	Code	No.
3	130	23.5	0.020	2324849	V 42 3
4	120	40.0	0.025	2324857	V 42 4
5	140	48.0	0.045	2324865	V 42 5
6	140	48.0	0.060	2324873	V 42 6
8	150	51.0	0.110	2324881	V 42 8
10	220	51.0	0.230	2324903	V 42 10
12	260	61.5	0.350	2324911	V 42 12

## V 42 T

### VDE HEXAGON ALLEN KEY

#### WITH T-HANDLE

1000 V

for in-hex screws

- > Individually tested, insulation up to 1000 V
- > With Check-Tool insulation
- > GEDORE chrome-vanadium steel 59CrV4



mm	mm	X	kg	Code	No.
4	160	X	0.145	2661225	V 42 T 4
5	160	X	0.250	2661233	V 42 T 5
6	160	X	0.250	2661241	V 42 T 6
8	160	X	0.260	2661268	V 42 T 8
10	200	-	0.390	2661276	V 42 T 10
11	200	-	0.400	2661284	V 42 T 11
12	200	-	0.420	2661292	V 42 T 12

## VDE 2170

### VDE SCREWDRIVER

1000 V

for slotted head screws

- > Individually tested, VDE insulation up to 1000 V, acc. to EN 60900/IEC 60900, fully insulated blade
- > Tip to DIN ISO 2380-1 form B
- > 3-component handles Power-Grip<sup>3</sup> with hanging hole
- > Ergonomic handle design enables precise and fatigue-free working
- > Positive-fit joint of handle and blade for optimum transmission of force
- > Type of drive marked at end of the handle
- > Blade from GEDORE molybdenum-vanadium-Plus tempered steel



mm	mm	mm	mm	kg	Code	No.
2.5	0.4	75	160	0.038	1612220	VDE 2170 2,5
3.0	0.5	100	185	0.042	1612239	VDE 2170 3
3.5	0.6	100	185	0.055	1612247	VDE 2170 3,5
4.0	0.8	100	185	0.058	1612255	VDE 2170 4
5.5	1.0	125	225	0.095	1612271	VDE 2170 5,5
6.5	1.2	150	260	0.134	1612298	VDE 2170 6,5
8.0	1.2	175	295	0.158	1612301	VDE 2170 8
10.0	1.6	200	320	0.208	1612336	VDE 2170 10





# SLIM DRIVE

No problems in reaching screws deeply embedded in screw shafts

- › Ultra-small blade diameter yet with full mechanical and electrical safety
- › No problems in reaching screws deeply embedded in screw shafts
- › VDE insulation up to 1000 V, acc. to EN 60900/IEC 60900, fully insulated blade
- › 3-component handles Power-Grip<sup>3</sup> with hanging hole
- › Ergonomic handle design enables precise and fatigue-free working
- › Positive-fit joint of handle and blade for optimum transmission of force
- › Type of drive marked at end of the handle
- › Blade from GEDORE molybdenum-vanadium-Plus tempered steel

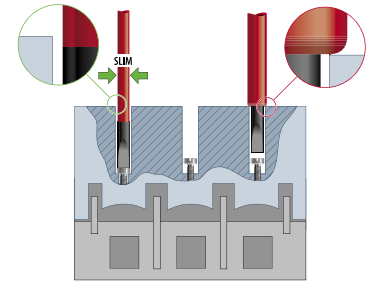

## VDE 2172 VDE SCREWDRIVER SLIM DRIVE

for slotted head screws

- › Individually tested, VDE insulation up to 1000 V, acc. to EN 60900/IEC 60900, fully insulated blade
- › 3-component handles Power-Grip<sup>3</sup> with hanging hole
- › Ergonomic handle design enables precise and fatigue-free working
- › Positive-fit joint of handle and blade for optimum transmission of force
- › Type of drive marked at end of the handle
- › Ultra-small blade diameter yet with full mechanical and electrical safety
- › No problems in reaching screws deeply embedded in screw shafts
- › Blade from GEDORE molybdenum-vanadium-Plus tempered steel



⊖ mm ±	mm ±	mm ±	mm ±	kg	Code	No.
3.5	0.6	100	185	0.055	2824736	VDE 2172 3,5
4.0	0.8	100	185	0.055	2824744	VDE 2172 4
5.5	1.0	125	225	0.100	2824752	VDE 2172 5,5
6.5	1.2	150	260	0.140	2824760	VDE 2172 6,5

## V 2160 MS PH SCREWDRIVER MAVO

for cross-head screws PH

△ 1000 V

- › No-contact voltage finder and fitted magnetic field tester
- › Voltage fields are displayed in red and magnetic fields in green
- › The no-contact voltage finder detects energised conductors. The capacitive testing method can localise a break in the cable down to a few millimeters.
- › The magnetic field tester examines the function of electro-magnetic switches and valves without having to place the switch out of service. Both permanent and alternating magnetic fields are displayed
- › 3-component handles Power-Grip<sup>3</sup>
- › Ergonomic handle design enables precise and fatigue-free working
- › Positive-fit joint of handle and blade for optimum transmission of force
- › Blade from GEDORE molybdenum-vanadium-Plus tempered steel
- › Individually tested, insulation up to 1000 V



⊕ PH	M	mm ±	mm ±	kg	Code	No.
2	M3,5 - M5	100	210	0.140	2824434	V 2160 MS PH 2

## VDE 2160 PH VDE SCREWDRIVER

for cross-head screws PH



- › Individually tested, VDE insulation up to 1000 V, acc. to EN 60900/IEC 60900, fully insulated blade
- › Blade tip to DIN ISO 8764-1 PH
- › 3-component handles Power-Grip<sup>3</sup> with hanging hole
- › Ergonomic handle design enables precise and fatigue-free working
- › Positive-fit joint of handle and blade for optimum transmission of force
- › Type of drive marked at end of the handle
- › Blade from GEDORE molybdenum-vanadium-Plus tempered steel



⊕ PH	M	mm ±	mm ±	kg	Code	No.
0	M1,6 - M2	60	145	0.039	1612107	VDE 2160 PH 0
1	M2 - M3	80	180	0.082	1612115	VDE 2160 PH 1
2	M3,5 - M5	100	210	0.119	1612123	VDE 2160 PH 2
3	M5,5 - M7	150	270	0.188	1612131	VDE 2160 PH 3
4	M8 - M10	200	320	0.269	1612158	VDE 2160 PH 4

## VDE 2160 PZ VDE SCREWDRIVER

for cross-head screws Pozi PZ



- › Individually tested, VDE insulation up to 1000 V, acc. to EN 60900/IEC 60900, fully insulated blade
- › Blade tip to DIN ISO 8764-1 PZ
- › 3-component handles Power-Grip<sup>3</sup> with hanging hole
- › Ergonomic handle design enables precise and fatigue-free working
- › Positive-fit joint of handle and blade for optimum transmission of force
- › Type of drive marked at end of the handle
- › Blade from GEDORE molybdenum-vanadium-Plus tempered steel



⊕ PZ	M	mm ±	mm ±	kg	Code	No.
0	M1,6 - M2	60	145	0.038	1612166	VDE 2160 PZ 0
1	M2 - M3	80	180	0.082	1612182	VDE 2160 PZ 1
2	M3,5 - M5	100	210	0.120	1612190	VDE 2160 PZ 2
3	M5,5 - M7	150	270	0.188	1612204	VDE 2160 PZ 3
4	M8 - M10	200	320	0.270	1612212	VDE 2160 PZ 4

## VDE 2162 PH VDE SCREWDRIVER SLIM DRIVE



for cross-head screws PH

- > Individually tested, VDE insulation up to 1000 V, acc. to EN 60900/IEC 60900, fully insulated blade
- > 3-component handles Power-Grip<sup>3</sup> with hanging hole
- > Ergonomic handle design enables precise and fatigue-free working
- > Positive-fit joint of handle and blade for optimum transmission of force
- > Type of drive marked at end of the handle
- > Ultra-small blade diameter yet with full mechanical and electrical safety
- > No problems in reaching screws deeply embedded in screw shafts
- > Blade from GEDORE molybdenum-vanadium-Plus tempered steel



⊕ PH	M	mm	mm	kg	Code	No.
1	M2 - M3	80	180	0.100	2824442	VDE 2162 PH 1
2	M3,5 - M5	100	210	0.140	2824450	VDE 2162 PH 2

## VDE 2162 PZ VDE SCREWDRIVER SLIM DRIVE



for cross-head screws Pozi PZ

- > Individually tested, VDE insulation up to 1000 V, acc. to EN 60900/IEC 60900, fully insulated blade
- > 3-component handles Power-Grip<sup>3</sup> with hanging hole
- > Ergonomic handle design enables precise and fatigue-free working
- > Positive-fit joint of handle and blade for optimum transmission of force
- > Type of drive marked at end of the handle
- > Ultra-small blade diameter yet with full mechanical and electrical safety
- > No problems in reaching screws deeply embedded in screw shafts
- > Blade from GEDORE molybdenum-vanadium-Plus tempered steel



⊕ PZ	M	mm	mm	kg	Code	No.
1	M2 - M3	80	180	0.100	2824469	VDE 2162 PZ 1
2	M3,5 - M5	100	210	0.140	2824477	VDE 2162 PZ 2

## VDE 2162-2172 PH-02 VDE SCREWDRIVER SET SLIM DRIVE



2 pieces

- > Practical set composition in environmentally-friendly cardboard box
- > For slotted and cross-head screws PH
- > Ultra-small blade diameter yet with full mechanical and electrical safety
- > No problems in reaching screws deeply embedded in screw shafts
- > VDE insulation up to 1000 V, acc. to EN 60900/IEC 60900, fully insulated blade
- > 3-component handles Power-Grip<sup>3</sup> with hanging hole
- > Ergonomic handle design enables precise and fatigue-free working
- > Positive-fit joint of handle and blade for optimum transmission of force
- > Type of drive marked at end of the handle
- > Blade from GEDORE molybdenum-vanadium-Plus tempered steel



Contents	kg	Code	No.
⊖ VDE 2172 3,5	0.195	2928736	VDE 2162-2172 PH-02
⊕ VDE 2162 PH 2			

## VDE 2162-2172 PM-06 VDE SCREWDRIVER SET SLIM DRIVE



6 pieces

- > Practical set composition in environmentally-friendly cardboard box
- > For slotted and cross-head screws PH as well as Plus-Minus screws
- > Ultra-small blade diameter yet with full mechanical and electrical safety
- > No problems in reaching screws deeply embedded in screw shafts
- > VDE insulation up to 1000 V, acc. to EN 60900/IEC 60900, fully insulated blade
- > 3-component handles Power-Grip<sup>3</sup> with hanging hole
- > Ergonomic handle design enables precise and fatigue-free working
- > Positive-fit joint of handle and blade for optimum transmission of force
- > Type of drive marked at end of the handle
- > Blade from GEDORE molybdenum-vanadium-Plus tempered steel

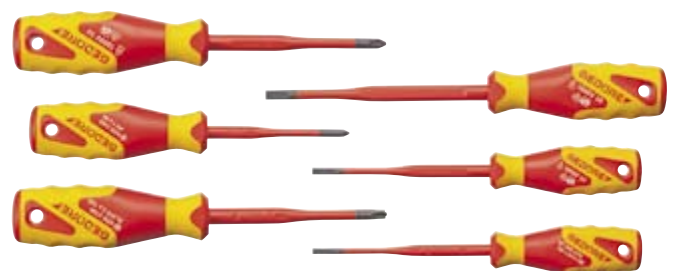

Contents	kg	Code	No.
⊖ VDE 2172 3,5 4 5,5	0.590	2928701	VDE 2162-2172 PM-06
⊕ VDE 2162 PH 1 2			
⊕ VDE 2164 SL/PH 2			





## VDE 2162-2172 PZ-06 VDE SCREWDRIVER SET SLIM DRIVE



6 pieces

- > Practical set composition in environmentally-friendly cardboard box
- > For slotted and cross-head screws PZ
- > Ultra-small blade diameter yet with full mechanical and electrical safety
- > No problems in reaching screws deeply embedded in screw shafts
- > VDE insulation up to 1000 V, acc. to EN 60900/IEC 60900, fully insulated blade
- > 3-component handles Power-Grip<sup>3</sup> with hanging hole
- > Ergonomic handle design enables precise and fatigue-free working
- > Positive-fit joint of handle and blade for optimum transmission of force
- > Type of drive marked at end of the handle
- > Blade from GEDORE molybdenum-vanadium-Plus tempered steel

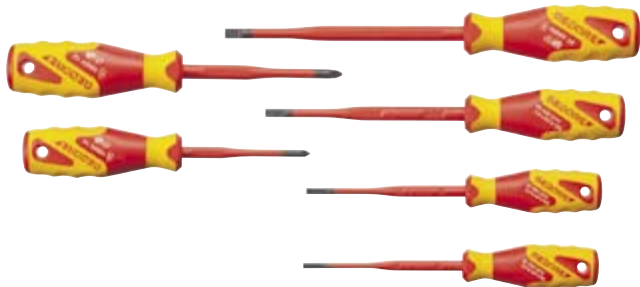

Contents		Code	No.
⊖ VDE 2172 3,5 4 5,5 6,5	0.590	2928728	VDE 2162-2172 PZ-06
⊕ VDE 2162 PZ 1 2			

## VDE 2163 K VDE SCREWDRIVER



for in-hex screws, with ball end

- > Individually tested, VDE insulation up to 1000 V, acc. to EN 60900/IEC 60900, fully insulated blade
- > 3-component handles Power-Grip<sup>3</sup> with hanging hole
- > Ergonomic handle design enables precise and fatigue-free working
- > Positive-fit joint of handle and blade for optimum transmission of force
- > Type of drive marked at end of the handle
- > Working angle approx. 25° in each direction
- > Blade from GEDORE molybdenum-vanadium-Plus tempered steel



				Code	No.
2,5	75	160	0.055	2824485	VDE 2163 K 2,5
3	75	160	0.055	2824493	VDE 2163 K 3
4	75	160	0.055	2824507	VDE 2163 K 4
5	75	175	0.100	2824515	VDE 2163 K 5
6	100	210	0.140	2824523	VDE 2163 K 6
8	100	220	0.222	2824531	VDE 2163 K 8

## VDE 2164 VDE SCREWDRIVER SLIM DRIVE PLUSMINUS



Plus-Minus

- > Individually tested, VDE insulation up to 1000 V, acc. to EN 60900/IEC 60900, fully insulated blade
- > 3-component handles Power-Grip<sup>3</sup> with hanging hole
- > Ergonomic handle design enables precise and fatigue-free working
- > Positive-fit joint of handle and blade for optimum transmission of force
- > Type of drive marked at end of the handle
- > Ultra-small blade diameter yet with full mechanical and electrical safety
- > No problems in reaching screws deeply embedded in screw shafts
- > Blade from GEDORE molybdenum-vanadium-Plus tempered steel



				Code	No.
80	180	0.100	2824817	VDE 2164 SL/PH1	
100	210	0.140	2824825	VDE 2164 SL/PH2	

## VDE 2163 TX VDE SCREWDRIVER



for recessed TORX® head screws

- > Individually tested, VDE insulation up to 1000 V, acc. to EN 60900/IEC 60900, fully insulated blade
- > 3-component handles Power-Grip<sup>3</sup> with hanging hole
- > Ergonomic handle design enables precise and fatigue-free working
- > Positive-fit joint of handle and blade for optimum transmission of force
- > Type of drive marked at end of the handle
- > Blade from GEDORE molybdenum-vanadium-Plus tempered steel
- > TORX® = reg. trademark of Acument Intellectual Properties, LLC. USA



						Code	No.
T5	M1,8	1,42	60	145	0.055	2824558	VDE 2163 TX T5
T6	M2	1,69	60	145	0.100	2824574	VDE 2163 TX T6
T7	M2,5	1,99	60	145	0.100	2824582	VDE 2163 TX T7
T8	M2,5	2,31	60	145	0.100	2824590	VDE 2163 TX T8
T9	M3	2,50	60	145	0.100	2824604	VDE 2163 TX T9
T10	M3 - M3,5	2,74	60	145	0.100	2824612	VDE 2163 TX T10
T15	M3,5 - M4	3,27	80	180	0.100	2824620	VDE 2163 TX T15
T20	M4 - M5	3,86	80	180	0.100	2824639	VDE 2163 TX T20
T25	M4,5 - M5	4,43	80	180	0.100	2824647	VDE 2163 TX T25
T27	M4,5 - M6	4,99	100	210	0.100	2824655	VDE 2163 TX T27
T30	M6 - M7	5,52	100	210	0.140	2824663	VDE 2163 TX T30
T40	M7 - M8	6,65	150	270	0.140	2824671	VDE 2163 TX T40
T45	M8 - M10	7,82	150	270	0.222	2824698	VDE 2163 TX T45

## VDE 2170-2160 PH-077 VDE SCREWDRIVER SET



7 pieces

- > Packed in environmentally-friendly cardboard box
- > For slotted and cross-head screws PH
- > VDE insulation up to 1000 V, acc. to EN 60900/IEC 60900, fully insulated blade
- > 3-component handles Power-Grip<sup>3</sup> with hanging hole
- > Ergonomic handle design enables precise and fatigue-free working
- > Positive-fit joint of handle and blade for optimum transmission of force
- > Type of drive marked at end of the handle
- > Blade from GEDORE molybdenum-vanadium-Plus tempered steel

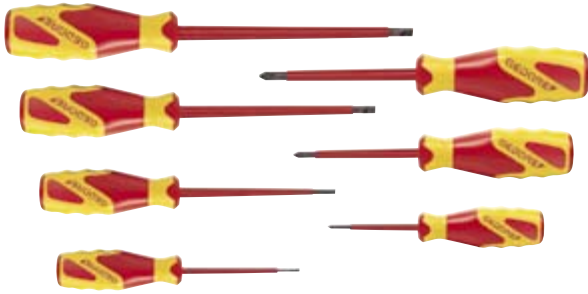

Contents		Code	No.
⊖ VDE 2170 2,5 4 5,5 6,5	0.575	1616048	VDE 2170-2160 PH-077
⊕ VDE 2160 PH 0 1 2			

## VDE 4616 VOLTAGE TESTER 1000 V



two-pole with LED display

- > Voltage 12 V - 1000 V AC/ DC (LED)
- > Display stages: 12, 24, 50, 120, 230, 400, 690, 1000 V AC/ DC
- > Acoustic and optical continuity test up to 100 kΩ (buzzer/ yellow LED)
- > Phase sequence test (green LED), phase test (red LED), polarity test (LED)
- > Direct displaying without pressing a push-button (high-impedance test)
- > Load connection via push-buttons (low-impedance test)
- > Intended release of a 30 mA RCD safety switch
- > Non-contact phase tester/detector of cable breaks (yellow LED flashing)
- > Vibrating alert in the test handle
- > Measuring point illumination
- > Protection classification IP65, dust-proof, hose-proof
- > Robust housing with rubberized gripping surface
- > Tested and approved acc. to IEC/EN 61243-3:2015
- > Over voltage category CAT IV 600 V, CAT III 1000 V
- > Incl. 2x 1.5 V micro batteries (LR03/ AAA) (voltage display from 50 V even in case of empty batteries)



	Code	No.
0.360	3032744	VDE 4616

## 4615 VOLTAGE TESTER



- > For 220-250 Volt AC
- > Blade nickel-plated, fully insulated blade conforming to DIN VDE 0680-6
- > 4615 3 with metal clip and yellow cap



mm	mm				Code	No.
⊖ 3.0	0.5	60	140	0.022	6699110	4615 3
⊖ 3.5	0.6	90	180	0.037	6699380	4615 3,5

## V 180 CABLE SHEARS



- > Cuts cable up to 27 mm, solid material up to 200 mm<sup>2</sup>
- > Individually tested, insulation up to 1000 V



		Code	No.
620	2.125	6430330	V 180 23



## V 8091 CABLE CUTTER

1000 V

- > For cutting copper and aluminium cables
- > Genuine single-hand operation, with optimum transfer of force. Handles ergonomically designed for fatigue-free constant use. Little hand pressure required even at maximum loading. For step-by-step cutting with burr-free cut, may be opened in every cutting position. With locking lever.
- > Tool body in high-tensile special steel
- > Cutting edges and important functional parts tempered or specially hardened
- > Red plastic handles insulated
- > Individually tested, insulation up to 1000 V
- > V 8091-320: single-core cable, max. Ø 25 mm (1"), multi-core cable, max. Ø 32 mm (1.1/4")
- > V 8091-500: multi-core cable, max. Ø 52 mm (2.1/32")



V 8091-320

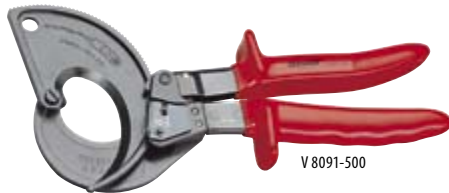

V 8091-500

↳ mm	↕ kg	Code	No.
280	0.792	6725130	V 8091-320
280	0.999	6725210	V 8091-500

## VDE 8094 VDE CABLE SHEARS

with VDE dipped insulation

1000 V

- > For cutting multi-core copper and aluminium cables up to Ø 20 mm
- > When using first and final cuts, the diameter increases to Ø 25 mm
- > The handle width remains within the range of ergonomic single-hand operation
- > First cut: Use the front blade to cut the cable sheath
- > Final cut: Place the cable in the back blade and separate the wire(s)
- > Cutting edges additionally inductively hardened
- > Precision ground for optimum action, new cutting-edge geometry
- > Adjustable screw joint with finger protection
- > Not suitable for steel wire or hard-drawn copper wire
- > Special tool steel, forged, gun-metal finish
- > Handles with VDE insulation up to 1000 V, acc. to EN 60900/IEC 60900, two-ply Check-Tool insulation



Ø	mm <sup>2</sup>	↳ mm	↳ inch	↕ kg	Code	No.
20	70	200	8.1/2	0.423	6725050	VDE 8094

## VDE 8098 VDE STRIPPING PLIERS

with VDE dipped insulation

1000 V

- > Opening stop, spring and brass adjusting screw
- > For cables 0.8 - 6.0 mm<sup>2</sup>
- > GEDORE special hardened and tempered steel, chrome-plated
- > Handles with VDE dipped insulation up to 1000 V, acc. to EN 60900/IEC 60900, two-ply Check-Tool insulation

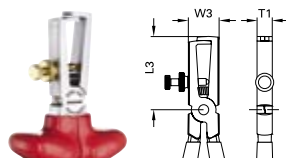

L	L <sub>2</sub>	W <sub>3</sub>	T <sub>1</sub>	mm <sup>2</sup>	↕ kg	Code	No.
160	43.5	18.5	8.5	0,8-6	0.217	6708980	VDE 8098-160

## VDE 8098 H VDE STRIPPING PLIERS

with VDE insulating sleeves

1000 V

- > Opening stop, spring and brass adjusting screw
- > For cables 0.8 - 6.0 mm<sup>2</sup>
- > GEDORE special hardened and tempered steel, chrome-plated
- > Handles with VDE insulating sleeves up to 1000 V, acc. to EN 60900/IEC 60900

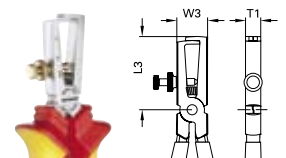

L	L <sub>2</sub>	W <sub>3</sub>	T <sub>1</sub>	mm <sup>2</sup>	↕ kg	Code	No.
160	43.5	18.5	8.5	0,8-6	0.204	1552074	VDE 8098-160 H

## VDE 8099

### VDE STRIPPING PLIERS STRIP-FIX



with VDE dipped insulation

- > Self-adjusting
- > For cables 0.5 - 5.0 mm<sup>2</sup>
- > GEDORE special hardened and tempered steel, oil-hardened, chrome-plated
- > Handles with VDE dipped insulation up to 1000 V, acc. to EN 60900/IEC 60900, two-ply Check-Tool insulation
- > Pair of spare knives no. E-8099



↳ mm	↳ inch	mm <sup>2</sup>	kg	Code	No.
160	6.1/2	0,5-5	0.226	6709600	VDE 8099-160

## VDE 8099 H

### VDE STRIPPING PLIERS STRIP-FIX



with VDE insulating sleeves

- > Self-adjusting
- > For cables 0.5 - 5.0 mm<sup>2</sup>
- > V-shaped cutting jaws for stripping the plastic insulation of single- and multi-core conductors
- > GEDORE special hardened and tempered steel, oil-hardened, chrome-plated
- > Handles with VDE insulating sleeves up to 1000 V, acc. to EN 60900/IEC 60900
- > Pair of spare knives no. E-8099



↳ mm	↳ inch	mm <sup>2</sup>	kg	Code	No.
160	6.1/2	0,5-5	0.211	1552082	VDE 8099-160 H

## E-8099

### PAIR OF SPARE KNIVES

for stripping pliers STRIP-FIX

kg	Code	No.
0.012	5709580	E-8099

## VDE 8131 AB

### VDE MULTIPLE PLIERS

with VDE insulating sleeves, angled pattern



- > Particularly tailored to the needs of electricians, in VDE execution with the following functions:
- > Cable cutter: enables easy cutting of cables up to 5x2.5 mm<sup>2</sup> resp. Ø 12 mm
- > Stripping blades: stripping possibility for wires 1,5 mm<sup>2</sup> and 2,5 mm<sup>2</sup>
- > Crimp profile: crimping of conductor end-sleeves
- > Toothed gripping face: special holding capacity when pulling cables and wires during installations
- > Angled plier tip: guarantees gentle work for wrists and gives sight on to the workpiece
- > Space-saving in the pocket, only one tool is needed
- > Handles with VDE insulating sleeves up to 1000 V, acc. to EN 60900/IEC 60900

## VDE 146

### VDE UNIVERSAL PLIERS

7 settings



- > Gripping pliers with safety box joint and finger protection
- > GEDORE special chrome-vanadium steel
- > Handles with VDE dipped insulation up to 1000 V, acc. to EN 60900/IEC 60900, two-ply Check-Tool insulation



↳ mm	mm	kg	Code	No.
250	31	0.485	6120140	VDE 146 10



↳ mm	kg	Code	No.
200	0.217	2910845	VDE 8131 AB-200 H



## VDE 8250 VDE HEAVY DUTY COMBINATION PLIERS



with VDE dipped insulation

- > For heavy continuous use
- > Good lever action for easy cutting
- > Induction-hardened precision cutting edges, hardness 62 - 64 HRC
- > For flat and round material
- > To cut all wire types including piano wire, 1.6 mm
- > GEDORE special hardened and tempered steel, chrome-plated
- > Handles with VDE dipped insulation up to 1000 V, acc. to EN 60900/IEC 60900, two-ply Check-Tool insulation



L	L <sub>3</sub>	W <sub>3</sub>	W <sub>4</sub>	T <sub>1</sub>		Code	No.
160	35.0	22.8	5.8	10.4	0.236	1429582	VDE 8250-160
180	38.5	25.6	6.5	11.0	0.312	6720090	VDE 8250-180
200	39.5	27.0	6.5	12.4	0.365	6720250	VDE 8250-200
225	42.2	27.7	6.5	13.0	0.485	6720330	VDE 8250-225

## VDE 8250 H VDE HEAVY DUTY COMBINATION PLIERS



with VDE insulating sleeves

- > For heavy continuous use
- > Good lever action for easy cutting
- > Induction-hardened precision cutting edges, hardness 62 - 64 HRC
- > For flat and round material
- > To cut all wire types including piano wire, 1.6 mm
- > GEDORE special hardened and tempered steel, chrome-plated
- > Handles with VDE insulating sleeves up to 1000 V, acc. to EN 60900/IEC 60900



L	L <sub>3</sub>	W <sub>3</sub>	W <sub>4</sub>	T <sub>1</sub>		Code	No.
160	35.0	22.8	5.8	10.4	0.228	1550942	VDE 8250-160 H
180	38.5	25.6	6.5	11.0	0.288	1550950	VDE 8250-180 H
200	39.5	27.0	6.5	12.4	0.369	1550969	VDE 8250-200 H

## VDE 8314 VDE SIDE CUTTER



with VDE dipped insulation

- > With slender head - ideal for confined spaces
- > Induction-hardened precision cutting edges, hardness 63 - 65 HRC
- > For medium-hard wire, 1.6 mm
- > GEDORE special hardened and tempered steel, chrome-plated
- > Handles with VDE dipped insulation up to 1000 V, acc. to EN 60900/IEC 60900, two-ply Check-Tool insulation



L	L <sub>3</sub>	W <sub>3</sub>	T <sub>1</sub>	∅		Code	No.
140	18.5	18.5	9.5	1,6	0.199	6743540	VDE 8314-140
160	19.0	22.0	10.0	1,6	0.253	6743620	VDE 8314-160



# (VDE) 8314-180

Particularly suitable for electrical installation work

Max. safety when used under voltages thanks to the long, insulated handle with non-slip mechanism

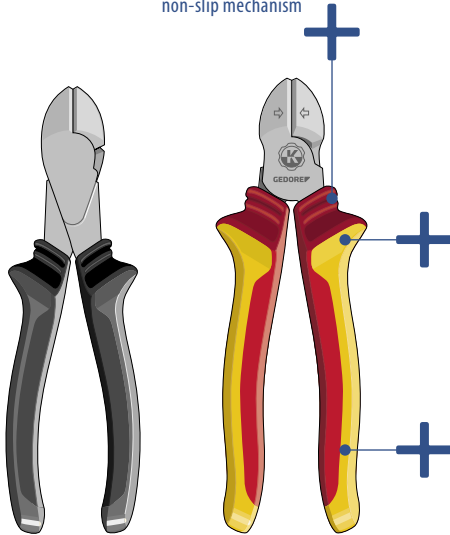

Long contoured handle for a heightened transfer of force and improved stable hold particularly with large cable diameters

Convex handle shape for a high force build-up\*

Longer XL cutting edges than comparable side cutters cables allow cables to be cut from a Ø up to 15 mm (5x2,5 mm<sup>2</sup>)

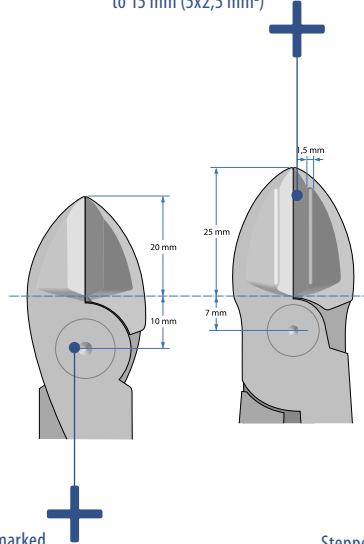

Power side cutter thanks to a marked transfer of the pivot to the cutter

Stepped cutting edges make "cutting" easier and protect the cutting material

\* Crowned surfaces/handles - i.e. which are hardly rounded - prevent unfavourable, punctual peak forces. As a result, the force is evenly spread across your hand.

## VDE 8314-180 H VDE SIDE CUTTER with VDE insulating sleeves

**NEW**



- > With slender head - ideal for confined spaces
- > Induction-hardened precision cutting edges, hardness 63 - 65 HRC
- > For hard wire/piano wire
- > Max. cutting capacity Ø 1.6 - 2.0 mm
- > GEDORE special hardened and tempered steel, chrome-plated
- > Handles with VDE insulating sleeves up to 1000 V, acc. to EN 60900/IEC 60900

## VDE 8314 H VDE SIDE CUTTER with VDE insulating sleeves



- > With slender head - ideal for confined spaces
- > Induction-hardened precision cutting edges, hardness 63 - 65 HRC
- > For medium-hard wire, 1.6 mm
- > GEDORE special hardened and tempered steel, chrome-plated
- > Handles with VDE insulating sleeves up to 1000 V, acc. to EN 60900/IEC 60900

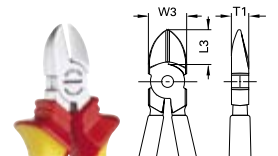
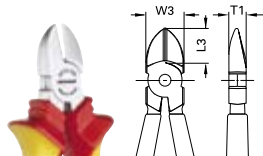

L	L <sub>3</sub>	W <sub>3</sub>	T <sub>1</sub>	Ø	kg	Code	No.
185	25	26	11	1,6-2,0	0.297	2910950	VDE 8314-180 H

L	L <sub>3</sub>	W <sub>3</sub>	T <sub>1</sub>	Ø	kg	Code	No.
140	18.5	18.5	9.5	1,6	0.177	1552155	VDE 8314-140 H
160	19.0	22.0	10.0	1,6	0.231	1552163	VDE 8314-160 H





## VDE 8315 H VDE ELECTRICIANS' SIDE CUTTER

with VDE insulating sleeves

- > Double-function electricians' side cutters for cutting and wire stripping
- > Stripping holes for single- or multi-core conductors 1.5 and 2.5 mm<sup>2</sup>
- > Induction-hardened precision cutting edges
- > GEDORE special hardened and tempered steel, chrome-plated
- > Handles with VDE insulating sleeves up to 1000 V, acc. to EN 60900/IEC 60900

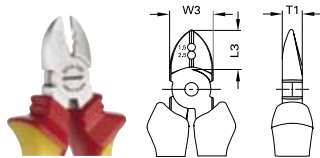

L	L <sub>1</sub>	W <sub>3</sub>	T <sub>1</sub>	mm <sup>2</sup>	Ø		Code	No.
160	19.0	22.0	10.0	1,5 / 2,5	1,6	0.231	1742582	VDE 8315-160 H



## VDE 8316 VDE POWER SIDE CUTTER

with VDE dipped insulation

- > Good lever action for easy cutting
- > Induction-hardened precision cutting edges, hardness 63 - 65 HRC
- > For hard wire/piano wire - values see table
- > Max. cutting capacity Ø 1.8 - 2.0 mm
- > GEDORE special hardened and tempered steel, chrome-plated
- > Handles with VDE dipped insulation up to 1000 V, acc. to EN 60900/IEC 60900, two-ply Check-Tool insulation

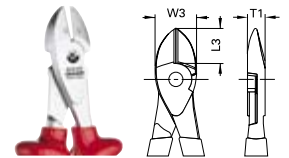

L	L <sub>1</sub>	W <sub>3</sub>	T <sub>1</sub>	Ø		Code	No.
180	22.6	26.0	11.0	1,8	0.285	1429590	VDE 8316-180
200	22.0	28.0	11.0	2,0	0.341	6742570	VDE 8316-200



## VDE 8316 H VDE POWER SIDE CUTTER

with VDE insulating sleeves

- > Good lever action for easy cutting
- > Induction-hardened precision cutting edges, hardness 63 - 65 HRC
- > For hard wire/piano wire - values see table
- > Max. cutting capacity Ø 1.8 - 2.0 mm
- > GEDORE special hardened and tempered steel, chrome-plated
- > Handles with VDE insulating sleeves up to 1000 V, acc. to EN 60900/IEC 60900

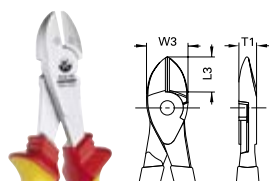

L	L <sub>1</sub>	W <sub>3</sub>	T <sub>1</sub>	Ø		Code	No.
180	22.6	26.0	11.0	1,8	0.267	1550993	VDE 8316-180 H
200	22.0	28.0	11.0	2,0	0.344	1551000	VDE 8316-200 H



## VDE 8367 VDE HEAVY DUTY END CUTTING NIPPERS

- > Good lever action for easy cutting
- > Induction-hardened precision cutting edges, hardness 63 - 65 HRC
- > For hard wire/piano wire 1.6 mm
- > GEDORE special hardened and tempered steel, drop-forged, oil-hardened and annealed
- > Handles with VDE dipped insulation up to 1000 V, acc. to EN 60900/IEC 60900, two-ply Check-Tool insulation

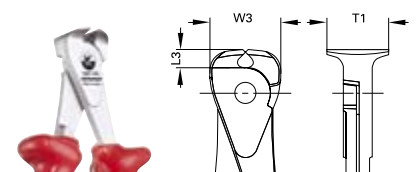

L	L <sub>1</sub>	W <sub>3</sub>	T <sub>1</sub>	Ø		Code	No.
160	6.9	27.0	23.5	1,6	0.220	2324830	VDE 8367-160





## VDE 8120 VDE FLAT NOSE PLIERS



with VDE dipped insulation

- > Long, flat jaws and serrated gripping surfaces
- > GEDORE special hardened and tempered steel, chrome-plated
- > Handles with VDE dipped insulation up to 1000 V, acc. to EN 60900/IEC 60900, two-ply Check-Tool insulation

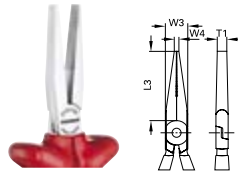

L	L <sub>3</sub>	W <sub>3</sub>	W <sub>4</sub>	T <sub>1</sub>		Code	No.
160	51.0	16.5	3.4	9.0	0.185	6715330	VDE 8120-160

## VDE 8120 H VDE FLAT NOSE PLIERS



with VDE insulating sleeves

- > Long, flat jaws and serrated gripping surfaces
- > GEDORE special hardened and tempered steel, chrome-plated
- > Handles with VDE insulating sleeves up to 1000 V, acc. to EN 60900/IEC 60900

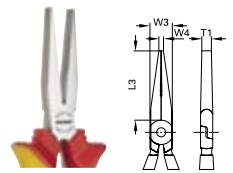

L	L <sub>3</sub>	W <sub>3</sub>	W <sub>4</sub>	T <sub>1</sub>		Code	No.
160	51.0	16.5	3.4	9.0	0.175	1552090	VDE 8120-160 H

## VDE 8122 VDE ROUND NOSE PLIERS



with VDE dipped insulation

- > Long, round jaws and serrated gripping surfaces
- > GEDORE special hardened and tempered steel, chrome-plated
- > Handles with VDE dipped insulation up to 1000 V, acc. to EN 60900/IEC 60900, two-ply Check-Tool insulation

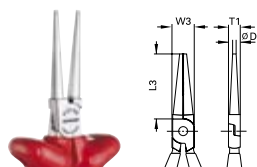

L	L <sub>3</sub>	W <sub>3</sub>	D <sub>1</sub>	T <sub>1</sub>		Code	No.
160	48	16.5	2.5	8.7	0.170	6717110	VDE 8122-160

## VDE 8122 H VDE ROUND NOSE PLIERS



with VDE insulating sleeves

- > Long, round jaws and serrated gripping surfaces
- > GEDORE special hardened and tempered steel, chrome-plated
- > Handles with VDE insulating sleeves up to 1000 V, acc. to EN 60900/IEC 60900

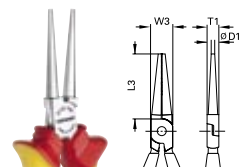

L	L <sub>3</sub>	W <sub>3</sub>	D <sub>1</sub>	T <sub>1</sub>		Code	No.
160	48	16.5	2.5	8.7	0.154	1552104	VDE 8122-160 H



## VDE 8132 VDE TELEPHONE PLIERS



with VDE dipped insulation, straight pattern

- > Long, flat-round jaws, straight gripping faces, serrated
- > Induction-hardened precision cutting edges, hardness 61 - 63 HRC
- > GEDORE special hardened and tempered steel, chrome-plated
- > Handles with VDE dipped insulation up to 1000 V, acc. to EN 60900/IEC 60900, two-ply Check-Tool insulation

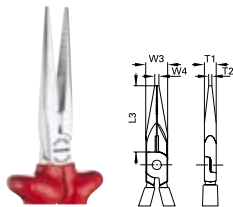

L	L <sub>1</sub>	W <sub>3</sub>	W <sub>4</sub>	T <sub>1</sub>	T <sub>2</sub>		Code	No.
160	50.0	16.5	3.2	9.0	2.5	0.193	6721570	VDE 8132-160
200	75.7	18.5	3.7	9.5	2.8	0.248	6721650	VDE 8132-200

## VDE 8132 H VDE TELEPHONE PLIERS



with VDE insulating sleeves, straight pattern

- > Long, flat-round jaws, straight gripping faces, serrated
- > Induction-hardened precision cutting edges, hardness 61 - 63 HRC
- > GEDORE special hardened and tempered steel, chrome-plated
- > Handles with VDE insulating sleeves up to 1000 V, acc. to EN 60900/IEC 60900

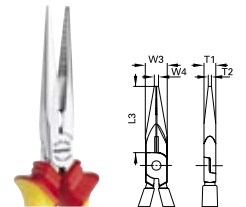

L	L <sub>1</sub>	W <sub>3</sub>	W <sub>4</sub>	T <sub>1</sub>	T <sub>2</sub>		Code	No.
160	50.0	16.5	3.2	9.0	2.5	0.164	1552112	VDE 8132-160 H
200	75.7	18.5	3.7	9.5	2.8	0.235	1552120	VDE 8132-200 H

## VDE 8132 AB VDE BENT NOSE TELEPHONE PLIERS



with VDE dipped insulation, angled pattern

- > Long, flat-round jaws, angled gripping surfaces, serrated
- > Induction-hardened precision cutting edges, hardness 61 - 63 HRC
- > GEDORE special hardened and tempered steel, chrome-plated
- > Handles with VDE dipped insulation up to 1000 V, acc. to EN 60900/IEC 60900, two-ply Check-Tool insulation

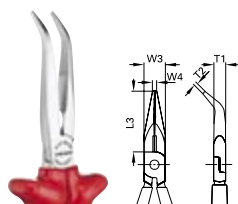

L	L <sub>1</sub>	W <sub>3</sub>	W <sub>4</sub>	T <sub>1</sub>	T <sub>2</sub>		Code	No.
160	46.0	16.5	3.2	9.0	2.5	0.177	6721730	VDE 8132 AB-160
200	70.5	18.5	3.7	9.5	2.8	0.252	6721810	VDE 8132 AB-200

## VDE 8132 AB H VDE BENT NOSE TELEPHONE PLIERS



with VDE insulating sleeves, angled pattern

- > Long, flat-round jaws, angled gripping surfaces, serrated
- > Induction-hardened precision cutting edges, hardness 61 - 63 HRC
- > GEDORE special hardened and tempered steel, chrome-plated
- > Handles with VDE insulating sleeves up to 1000 V, acc. to EN 60900/IEC 60900

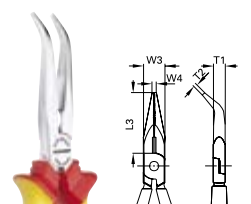

L	L <sub>1</sub>	W <sub>3</sub>	W <sub>4</sub>	T <sub>1</sub>	T <sub>2</sub>		Code	No.
160	46.0	16.5	3.2	9.0	2.5	0.173	1552139	VDE 8132 AB-160 H
200	70.5	18.5	3.7	9.5	2.8	0.235	1552147	VDE 8132 AB-200 H

## VDE S 8003

### VDE PLIERS SET WITH VDE DIPPED INSULATION



3 pieces

- > Packed in environmentally-friendly cardboard box
- > Handles with VDE dipped insulation up to 1000 V, acc. to EN 60900/IEC 60900, two-ply Check-Tool insulation



Contents		Code	No.
VDE 8132-160	0.760	6708120	VDE S 8003
VDE 8250-180			
VDE 8314-160			

## VDE S 8003 H

### VDE PLIERS SET WITH VDE INSULATING SLEEVES



3 pieces

- > Packed in environmentally-friendly cardboard box
- > Handles with VDE insulating sleeves up to 1000 V, acc. to EN 60900/IEC 60900



Contents		Code	No.
VDE 8132-160 H	0.747	1550594	VDE S 8003 H
VDE 8250-180 H			
VDE 8314-160 H			

## 1101-003 VDE

### VDE TOOL SET

in i-BOXX® 72, 8 pieces

- > VDE basic assortment
- > VDE insulation up to 1000 V, acc. to EN 60900/IEC 60900, except voltage tester no. 4615
- > In GEDORE i-BOXX® 72, with transparent cover for getting an immediate impression
- > Dimensions: W 367 x D 316 x H 72 mm



**NEW**

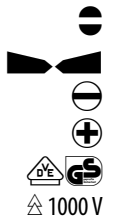

Contents		Code	No.
VDE 8132-200 H	1.700	1828045	1101-003 VDE
VDE 8250-180 H			
VDE 8314-160 H			
VDE 2170 4 5,5			
VDE 2160 PH 1 2			
4615 3			

1101 L

>62



1102 L

>63



## 1102-002 VDE VDE PLIERS SET

3 pieces

- > Handles with VDE insulating sleeves up to 1000 V, acc. to EN 60900/IEC 60900
- > In GEDORE L-BOXX® Mini, incl. divider set
- > Dimensions: W 260 x D 155 x H 63 mm

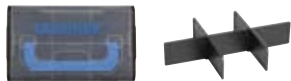

**NEW**



## 1102-004 VDE VDE PLIERS SET

3 pieces

- > Handles with VDE insulating sleeves up to 1000 V, acc. to EN 60900/IEC 60900
- > In GEDORE L-BOXX® Mini, incl. divider set
- > Dimensions: W 260 x D 155 x H 63 mm

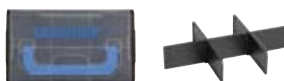

**NEW**



Contents	kg	Code	No.
VDE 8132-160 H	0.920	1692291	1102-002 VDE
VDE 8250-180 H			
VDE 8314-160 H			

Contents	kg	Code	No.
VDE 8098-160 H	0.950	1708244	1102-004 VDE
VDE 8250-180 H			
VDE 8314-160 H			

## 1102-005 VDE VDE PLIERS SET

3 pieces

- > Handles with VDE insulating sleeves up to 1000 V, acc. to EN 60900/IEC 60900
- > With VDE Power side cutter and VDE Multiple pliers
- > In GEDORE L-BOXX® Mini, incl. divider set
- > Dimensions: W 260 x D 155 x H 63 mm



**NEW**



## 1102-006 VDE VDE TOOL SET

4 pieces

- > Handles with VDE insulating sleeves up to 1000 V, acc. to EN 60900/IEC 60900
- > For all usual electric master cabinets incl. multi fitting key
- > In GEDORE L-BOXX® Mini, incl. divider set
- > Dimensions: W 260 x D 155 x H 63 mm



**NEW**



Contents	kg	Code	No.
VDE 8314-180 H	0.950	2951762	1102-005 VDE
VDE 8131 AB-200 H			
VDE 2162 PZ 1			

Contents	kg	Code	No.
VDE 8131 AB-200 H	0.863	2951770	1102-006 VDE
VDE 2172 3,5			
VDE 2164 SL/PH 2			
45 E			

Sheath-stripping, wire-stripping, crimping tools etc. can be found on pages 370 - 425

# S 1023

## TOOL ASSORTMENT FOR MECHANICAL ENGINEERS

120 pieces

- > Practical entry-level toolset
- > The range includes mechanical and electrical engineering tools
- > Suitable to fit in GEDORE tool trolley workster
- > Recommended hook assortment no. 1500 HS-1023 (53 pieces)



Contents	13.0	Code	No.
<b>120 tools in metric sizes</b>		1999060	S 1023
<b>Contents</b>	<b>Contents</b>	<b>Contents</b>	<b>Contents</b>
<b>1 B</b> 6 7 8 9 10 11 12 13 14 15 16 17 18 19 20 21 22	<b>VDE 8132</b> -200 H	<b>600 H</b> -500	
<b>D 20</b> 4 5 6 7 8 9 10 11 12 13	<b>VDE 8250</b> -180 H	<b>248 ST</b> -30	
<b>680</b> 4-25 5,5-25 6,5-25	<b>VDE 8314</b> -160 H	<b>8701</b> 2-8	
<b>685</b> 3-25 4-25 5-25 6-25	<b>VDE 2170</b> 4,5,5	<b>8719</b> 2-8	
<b>685 X</b> 5-25 6-25 8-25	<b>VDE 2160 PH</b> 12	<b>8722</b> 2-8	
<b>687 TX</b> T10-25 T15-25 T20-25 T25-25 T27-25 T30-25 T40-25	<b>VDE 4616</b>	<b>403</b>	
<b>690</b> 1-25 2-25	<b>4615</b> 3	<b>4528</b>	
<b>690 PZD</b> 1-25 2-25 3-25	<b>171 IS</b> 1,2,1,5,2	<b>710</b>	
<b>620</b>	<b>165 PH</b> 00 0	<b>745</b>	
<b>676</b>	<b>8305</b> -2	<b>4534</b> -3	
<b>699</b>	<b>8306</b> -5	<b>298</b> -04	
<b>2090</b> -4	<b>42</b> 1,3 1,5 2 (5/64AF) 2,5 3 4 5 6 8 10	<b>8354</b> -1	
<b>2093 U-20</b>	<b>97</b> -150	<b>8139</b> -220 TC	
<b>1993 U-20</b>	<b>100</b> -10		
<b>1990</b> -5 -10	<b>119</b> -3 -5		
<b>1995</b>			
<b>1987</b>			
<b>19</b> 8 9 10 11 12 13 14 15 16 17 18 19 21 22 24 27 30 32			



# S 1093









## VDE TOOL ASSORTMENT







26 pieces

- > Particularly suited as the initial outfit for electrical specialists
- > The GEDORE tool case or tool trolley are suited for mobile assignments
- > Recommended hook assortment 1500 HS-1093 (26 pieces)



Contents		Code	No.
<b>26 tools in metric sizes</b>	4.8	2319942	S 1093

Contents	
 <b>142 10 C</b>	
 <b>VDE 8250 -180 H</b>	
 <b>VDE 8132 -160 H</b>	
 <b>VDE 8314 -160 H</b>	
 <b>VDE 2170 4,5,6,8</b>	
 <b>VDE 2160 PZ 12</b>	
 <b>VDE 4616</b>	
 <b>42 2 (5/64AF) 2,5 3 4 5 6 8 10</b>	
 <b>4533 -2</b>	

Contents	
 <b>4528</b>	
 <b>8097</b>	
 <b>600 H -500</b>	
 <b>112 A -250</b>	
 <b>110 HS -318</b>	
 <b>0175 -06</b>	



# 1090 TOOL CASE ELECTRICIAN

90 pieces



- > The perfect tool set for the electrician or property manager
- > A thoughtful assortment for the work to be done
- > Packed in a strong plastic case
- > Aluminium frame, three steel hinges, screwed handle, fitted with built in locks
- > May be used wherever the right tools have to be always at hand
- > GEDORE vanadium tools, chrome-plated
- > Dimensions: W 480 x D 370 x H 180 mm



Contents	kg	Code	No.
<b>Tool set S 1090 + tool case WK 1090 L</b>	13.2	6601590	1090
<b>6</b> 14x17 18x19 21x23 22x24		<b>VDE 2160 PH 1 2</b>	<b>VDE 8120 -160</b>
<b>8</b> 4,4,5,5,5,6,7,8,9,10,11,12,13		<b>VDE 2170</b> 3,5,4,5,6,5	<b>VDE 8250 -180</b>
<b>20</b> 4,4,5,5,5,6,7,8,9,10,11,13		<b>4615</b> 3,5	<b>VDE 8132 AB -160</b>
<b>2087</b>		<b>173</b> 5,5,8	<b>VDE 8316 -200</b>
<b>2095</b>		<b>174</b> 1	<b>95 -175</b>
<b>2098</b>		<b>745</b>	<b>99</b> 10-2 10-4
<b>2090 -4</b>		<b>0513-09</b>	<b>101</b>
<b>2093 U -3</b>		<b>4534 -3</b>	<b>112 A -250</b>
<b>42</b> 2 (5/64AF) 2,5 3 4 5 6 7 8 10		<b>401</b>	<b>112 S</b>
<b>60 CP 10</b>		<b>401 A</b> [10x]	<b>600 H -300</b>
<b>156 S</b>		<b>145</b> 10 JC	<b>72 H -100</b>
<b>2153</b> 5,5		<b>8096 -140</b>	
<b>2161 PH 1</b>		<b>VDE 8098 -160</b>	
<b>2160 PZ 1 2</b>			
			<b>E-1090</b> LK LZ LF LS





**NEW**

# 1100-1094

## VDE TOOL ASSORTMENT HYBRID

53 pieces

- > The perfect range of tools for repairs and maintenance of hybrid and electric vehicles
- > For vehicles of all the manufacturers
- > All tools insulated on the basis of EN 60900/EC 60900
- > GEDORE L-BOXX® 136 compatible with the Sortimo® vehicle interior fittings in your service mobile



Contents

Contents	Code	No.
VDE 30 6 8 9 10 11 12 13 14 15 16 17 18 19 20 22	VDE 2160 PH 1 2 3 VDE 2163 TX T20 T25 T30	VDE 8132 AB-200 H VDE 8120-160 H
VDE INX 30 8 10 12	VDE 8094	VDE 4522
VDE 3090-3 -6	VDE 146 10	V 914 1 2 3
VDE 3093 U	VDE 8250-200 H	
VDE 2170 2,5 3,5 4 5,5	VDE 8314-180 H	

Contents	Code
VDE 30 6 8 9 10 11 12 13 14 15 16 17 18 19 20 22	VDE 2160 PH 1 PH 2 PH 3
VDE INX 30 8 10 12	VDE 2163 TX T20 T25 T30
VDE 3090 -3 -6	VDE 8094
VDE 3093 U	
VDE 2170 2,5 3,5 4 5,5	

Contents	Code
VDE 146 10	VDE 8132 AB -200 H
VDE 8250 -200 H	VDE 8120 -160 H
VDE 8314 -180 H	VDE 4522
VDE 8132 AB -200 H	V 914 V 914 1 [5x] V 914 2 [5x] V 914 3 [5x]



# VDE 1001

## VDE TOOL SET

14 pieces

- > With practical foam insert in sturdy PVC case
- > Dimensions: 395 x 295 x 106 mm
- > Cranked allen socket screwdriver no. 42 is for locking the adjusting screw of extension no. VDE 1990, not VDE insulated

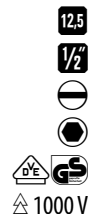

Contents	Code	No.	Contents	Contents
VDE 19 10 12 13 14 17 19 22 24	6602560	VDE 1001	VDE 19 10 12 13 14 17 19 22 24	VDE 1989 T
VDE 1993 U			VDE 1993 U	VDE 2170 5,5
VDE 1990-5 -10			VDE 1990 -5 -10	42 2,5
VDE 1989 T				
VDE 2170 5,5				
42 2,5				

## VDE 910 VDE RUBBER COVER SHEET



- > VDE protective equipment acc. to VDE 0680, Part 1
- > Thickness: 1.6 mm
- > Rolled storage prevents from cracking!



L	W		Code	No.
<b>130</b>	130	0.040	1826816	VDE 910 13
<b>250</b>	350	0.210	1826832	VDE 910 25
<b>500</b>	500	0.430	1827030	VDE 910 50
<b>600</b>	600	0.700	1828193	VDE 910 60
<b>1000</b>	1000	1.800	1828207	VDE 910 100
<b>1200</b>	1200	2.950	1828215	VDE 910 120

## V 911 VDE INSULATION MAT

△ 1000 V

- > VDE protective equipment acc. to VDE 0303
- > Thickness: 4.5 mm
- > Rolled storage prevents from cracking!



L	W		Code	No.
<b>1000</b>	1000	6.0	1828258	V 911 100
<b>10000</b>	1000	60.0	1828266	V 911 1000

## V 912 VDE ELECTRICIANS' SAFETY GLOVES

△ 1000 V

- > Acc. to DIN EN 60903
- > Made of natural latex



	Code	No.
<b>0.215</b>	1828274	V 912 9
<b>0.215</b>	1828282	V 912 10

## V 912 UNDER-GLOVES for VDE 912



	Code	No.
<b>0.050</b>	1828290	V 912 50

## V 915 NH-FUSE INSERTION GLOVE WITH SLEEVE

△ 1000 V

- > To work on NH fuse inserts sizes 00 to 3
- > To insert and remove low-tension high-performance fuses (NH fuse inserts)
- > Can also be used for other devices applied instead of the fuse inserts, e.g. earthing and short-circuiting devices, inserting or removing blind fuse elements
- > With contact blades to DIN 43620 Part 1, sizes 00 - 3 for nominal voltage to 600 V alternating voltage



	Code	No.
<b>0.460</b>	2661314	V 915

## V 913 PLASTIC CLAMP 1000 V



- > For fixing and joining plastic clamps
- > Inserted steel spring which externally cannot be accessed
- > For working under voltage up to 1000 V



V 913 80



V 913 160

		Code	No.
<b>80</b>	0.030	1828304	V 913 80
<b>160</b>	0.070	1828312	V 913 160



## V 914 VDE METER CONNECTION FITTINGS

⚡ 1000 V

- > For insulating single cores
- > Conical form
- > Made from resilient plastic
- > V 914 1 with Designation 1
- > V 914 2 with Designation 2
- > V 914 3 with Designation 3



l-mm>	∅	⚖	Code	No.
80	10	0.005	2324938	V 914 1
80	10	0.005	2324946	V 914 2
80	10	0.005	2324954	V 914 3

## V 917 CABLE SPLITTING WEDGE

⚡ 1000 V

- > Insulated acc. to IEC 60900
- > From polyamide
- > Suitable for mounting cable feeder terminals and splaying primary conductor cables
- > Assistance when cutting cable cores, no slipping



⚖	Code	No.
0.160	2661462	V 917

## VDE 4522 VDE CABLE KNIFE

⚡ GS  
⚡ 1000 V

- > Strong, straight blade made from hardened and tempered steel
- > Tough, resilient plastic handle
- > VDE insulation up to 1000 V, acc. to EN 60900/IEC 60900



⚖	Code	No.
0.104	6690400	VDE 4522

## VDE 4522 K VDE CABLE KNIFE

⚡ GS  
⚡ 1000 V

- > Strong, straight blade made from hardened and tempered steel
- > 2-component plastic handle
- > VDE insulation up to 1000 V, acc. to EN 60900/IEC 60900



⚖	Code	No.
0.105	2661497	VDE 4522 K

## VDE 4527 VDE CABLE KNIFE with hooked blade

⚡ GS  
⚡ 1000 V

- > For slitting and stripping damp-proof installation cables
- > With blade protector
- > VDE insulation up to 1000 V, acc. to EN 60900/IEC 60900



⚖	Code	No.
0.098	6698490	VDE 4527

## VDE 4527 K VDE CABLE KNIFE with hooked blade

⚡ GS  
⚡ 1000 V

- > For slitting and stripping damp-proof installation cables
- > Blade from hardened and tempered steel
- > With blade protector
- > VDE insulation up to 1000 V, acc. to EN 60900/IEC 60900



⚖	Code	No.
0.105	2661489	VDE 4527 K

## 4528 UNIVERSAL CABLE KNIFE

- > For stripping round cables, 4 - 28 mm
- > Hooked blade for separating cable strips and flat cables
- > No need to put down the knife when the blade is automatically switched from all-round to elongated cut
- > The cutting depth of the pivoting internal knife E-4528 is adjustable



### E-4528 INTERNAL KNIFE

- > The cutting depth of the pivoting internal knife is adjustable

			Code	No.
50	170	0.155	6698300	4528

	Code	No.
0.111	1448161	E-4528

## 4529 MULTI-USE CABLE KNIFE

**NEW**

- > For stripping round cables, 4 - 28 mm
- > Integrated stripping function for flexible and single-strand conductors
- > No need to put down the knife when the blade is automatically switched from all-round to elongated cut
- > The cutting depth of the pivoting internal knife E-4529 is adjustable



### E-4529 INTERNAL KNIFE

- > The cutting depth of the pivoting internal knife is adjustable

		Code	No.
145	0.150	2955393	4529

	Code	No.
0.111	2955407	E-4529

## 4629 INSULATING TAPE



L m	<u>mm</u>		Code	No.
10	15	0.032	6699540	4629

## V 406 HACKSAW

1000 V

- > For pinned hacksaw blades, 148 mm
- > Insulated handle up to 1000 V



<u>L mm</u>		Code	No.
265	0.229	6120060	V 406

More insulated tools 1000 V on request!  
Haven't you found the right tool?

Ask us about custom-orders.  
Your problems are our assignments.





# INSTALLATION TOOLS

**PIPE CUTTERS**  
FOR STEEL AND CAST  
IRON PIPES  
>598



**PIPE CUTTERS / PIPE  
DEBURRING REAMER**  
FOR STAINLESS STEEL  
PIPES  
>600



**PIPE CUTTERS / PIPE  
DEBURRING REAMER /  
CALIBRATING TOOL**  
FOR COPPER PIPES  
>602



**PIPE CUTTERS**  
FOR PLASTIC PIPES  
>604



**FLARING TOOLS**  
>606



**INSTALLATION TOOLS**  
>609



## Installation Tools

# APPLICATIONS OF THE GEDORE PIPE CUTTERS

	No. 210015	No. 2180..	No. 220...	No. 222...	No. 2250 3	No. 226100	No. 2268..	No. 2270..	No. 2300..	No. 2303..	No. 231000	No. 231011
Steel pipes EN 10255	3"-12"		1/8-2" (220020)	1/8-2" (222020)								
Steel pipes EN 10220			1.1/4-4" (220040)	1.1/4-4" (222040)								
Cast iron pipes EN 545, SML pipes EN 877	DN 80-300		DN 6-32 (220020) DN 32-100 (220040)	DN 6-32 (222020) DN 32-100 (222040)								
Electrical installation pipes EN 60423		M 12-32 (2180 3) M 12-40 (2180 4) M 12-63 (2180 5)								M 12-32 (230311) M 16-63 (230321)		M 12-16
Multi-layer composite pipes							≤ 42 mm (2268 2) ≤ 63 mm (2268 3)	6-76 mm (2270 5) 50-127 mm (2270 6)				
Plastic pipes					16, 19, 25 mm		≤ 42 mm (2268 2) ≤ 63 mm (2268 3)	6-76 mm (2270 5) 50-127 mm (2270 6)				
Copper pipes EN 1057		3-35 mm (2180 3)										
Sheated copper pipes		3-45 mm (2180 4)			3-35 mm				4-32 mm (230010) 13-65 mm (230020)	4-32 mm (230311) 13-65 mm (230321)	4-16 mm	4-16 mm
Thin-walled NF pipes		6-76 mm (2180 5)										
Hydraulic pipes EN 10305-1 (DIN 2391)		3-35 mm (2180 3)	10-42 mm (220020)	10-42 mm (222020)					4-32 mm (230010) 13-65 mm (230020)	4-32 mm (230311) 13-65 mm (230321)	4-16 mm	4-16 mm
Precision steel pipes EN 10305-3 (DIN 2394)		3-45 mm (2180 4) 6-76 mm (2180 5)	42-114 mm (220040)	42-114 mm (222040)	3-35 mm							
Stainless steel pipes EN 10088-3 (DIN 17 440)		3-35 mm (2180 3) 3-45 mm (2180 4) 6-76 mm (2180 5)	10-42 mm (220020 + 220221)	10-42 mm (222020 + 220221)						4-32 mm (230311) 13-65 mm (230321)		4-16 mm

\*) depending on size / finish / pipe properties

## Pipe Cutters for steel and cast iron pipes

### 210 LINK PIPE CUTTER

for steel, SML and cast iron pipes

- > Low space requirements due to ratchet-type operation
- > In the standard version suitable for pipes from 85 to 175 mm Ø
- > Can be extended if needed with extension set no. 210100, see table "Cutting range link pipe cutter no. 210015"
- > Enamelled blue



Ø mm	Wall thickness	kg	Code	No.
85-175	3,2-8,0	5.7	4536250	210015

### CUTTING RANGE OF THE LINK PIPE CUTTER NO. 210015

Cutting range from min. Internal Ø mm to max. External Ø mm	Number of cutting wheels	Accessories required
85 - 115	3*	
110 - 145	4*	
135 - 175	5	
165 - 200	6	1 x 210100
190 - 225	7	2 x 210100
220 - 250	8	3 x 210100
240 - 280	9	4 x 210100
270 - 300	10	5 x 210100
295 - 330	11	6 x 210100

\* the link pipe cutter must be reduced by the corresponding number of cutting wheels

### E 210 EXTENSION KIT

- > For extending the cutting range at No. 210015
- > For more information see table "Cutting range link pipe cutter no. 210015"

Contents	kg	Code	No.
<b>1 Cutting wheel for steel No. 210200</b>	0.400	2799626	210100
<b>1 Spare link No. 210500</b>			
<b>1 Spare bolt No. 210600</b>			

### E 210 SPARE PARTS



Description	Ø D	b	Ø d	kg	Code	No.
<b>Cutting wheel for 210015</b>	50	11	11	0.080	4536410	210200
<b>Spare link for 210015</b>				0.290	4551480	210500
<b>Spare bolt for 210015</b>				0.027	4536680	210600



## 220

### PIPE CUTTER TUBEX

for steel, SML and cast iron pipes

- > Heavy-duty pipe cutter with 1 cutting wheel
- > By exchanging the cutting wheels, may also be used for stainless steel pipes (size 2")
- > Frame in malleable cast steel
- > With elastic feed using especially-installed spring system (size 2")
- > Spindle protected by sleeve extension
- > Enamelled blue, spindle gun-metal finished

Version with 3 cutting wheels see no. 222



Size	Ø mm	Wall thickness	l- mm -l	⚖	Code	No.
1/8-2	10-60	2,0-6,3	380	2.9	4503400	220020
1.1/4-4	42-114	2,6-8,0	520	5.0	4503590	220040

## 222

### PIPE CUTTER TUBEX

for steel, SML and cast iron pipes

- > Heavy-duty pipe cutter with 3 cutting wheels
- > Ideal for working in confined, hard-to-reach places, since the cutter does not need to be turned through 360°
- > By exchanging the cutting wheels, may also be used for stainless steel pipes (size 2")
- > Frame in malleable cast steel
- > With elastic feed using especially-installed spring system (size 2")
- > Spindle protected by sleeve extension
- > Enamelled blue, spindle gun-metal finished

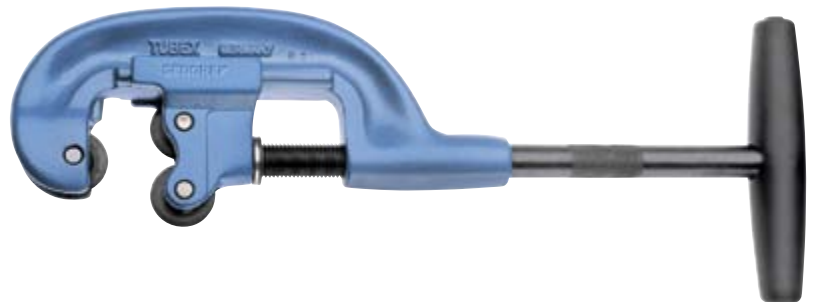

Size	Ø mm	Wall thickness	l- mm -l	⚖	Code	No.
1/8-2	10-60	2,0-6,3	380	2.7	4537060	222020
1.1/4-4	42-114	2,6-8,0	520	4.8	4553420	222040

## E 220 - E 222

### SPARE PARTS

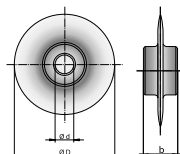

Description	Ø D	b	Ø d	⚖	Code	No.
Cutting wheel for 220020, 222020	32	19	9	0.028	4503750	220220
Cutting wheel for niro for 220020, 222020	32	19	9	0.028	1524038	220221
Cutting wheel for 220040, 222040	41	19	9	0.038	4503830	220240
Wheel bolt for 220020, 222020				0.015	4552450	220620
Wheel and pressure roller bolt for 220040, 222040				0.019	4552530	220640



## Pipe Cutters for stainless steel pipes

### 2180 PIPE CUTTER

for stainless steel pipes

- > Easy cutting due to ball-bearing pressure rollers and cutting wheels
- > Cutting wheel changeable without tools
- > With retractable deburring tool, spare cutting wheel in handle
- > Cutting wheel with high service life

- > No. 2180 3 and 2180 4 body in pressure-cast magnesium, no. 2180 5 body in pressure-cast aluminium
- > No. 2180 5 with quick-release
- > Enamelled blue



Ø mm	Wall thickness	l mm	kg	Code	No.
3-35	0,7-2,5	160	0.335	2964066	2180 3
3-45	0,7-2,5	180	0.355	2964074	2180 4
6-76	0,7-2,5	245	0.880	2964082	2180 5

### E 2180 SPARE PARTS



Description	Ø D	b	Ø d	kg	Code	No.
<b>Cutting wheel for 2180 3, 2180 4</b>	20	5.1	4.8	0.005	2964090	E-2180 3 A
<b>Cutting wheel for 2180 5</b>	20	6.2	4.8	0.008	2964104	E-2180 5 A
<b>Wheel bolt for 2180 3, 2180 4, 2250 3</b>				0.002	2964112	E-2180 3 B
<b>Wheel bolt for 2180 5, 2270 5</b>				0.005	2964120	E-2180 5 B

### 2303 PIPE CUTTER QUICK AUTOMATIC NIRO

for stainless steel pipes

- > Body in pressure-cast zinc
- > Cutting wheel made from high-alloy stainless steel, with high service life

- > Automatic infeed by plate springs
- > Enamelled blue

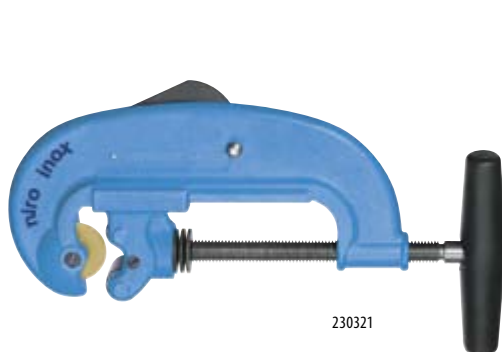

Ø mm	Wall thickness	l mm	kg	Code	No.
4-32	0,7-3,0	165	0.430	1154990	230311
13-65	1,0-3,0	275	1.420	1154850	230321

### E 2303 SPARE PARTS

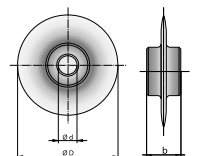

Description	Ø D	b	Ø d	kg	Code	No.
<b>Cutting wheel for stainless steel</b>	20	4.8	5.1	0.005	1154710	230411
<b>Cutting wheel for stainless steel</b>	32	9.9	6.1	0.018	1154680	230421
<b>Wheel bolt</b>				0.003	1154656	230611
<b>Wheel bolt</b>				0.003	1154540	230621

# 231011

## MINIATURE PIPE CUTTER MINI-QUICK NIRO

for stainless steel pipes

- > Particularly suitable for barely accessible places
- > Body in pressure-cast zinc
- > Cutting wheel with high service life
- > Enamelled blue



$\varnothing$ mm	Wall thickness	l mm	kg	Code	No.
4-16	0,7-2,0	50	0.125	4554070	231011

# E 231011

## SPARE PARTS

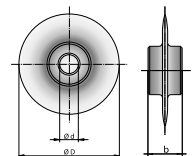

Description	$\varnothing$ D	b	$\varnothing$ d	kg	Code	No.
<b>Cutting wheel for stainless steel</b>	20	4.8	5.1	0.005	1154710	230411
<b>Wheel bolt</b>				0.003	1154656	230611

## Pipe Deburring Reamer for stainless steel pipes

# 2325

## PIPE DEBURRING REAMER

for stainless steel pipes

- > For internal and external deburring of stainless steel pipes
- > Aluminium body
- > Hardened taper section with 40 deburring blades



$\varnothing$ mm	l mm	kg	Code	No.
8-35	60	0.180	1857681	232501
10-56	85	0.420	1419684	232500

224011 / 224021

>546



4589

>546



## Pipe Cutters for copper pipes

**NEW**

### 2250 PIPE CUTTER

for copper pipes

- > For copper, brass, and light-alloy pipes, PVC hard plastic and plastic-coated pipes, thin-walled steel pipes, (precision steel and hydraulic pipes), composite pipes
- > Cutting wheel changeable without tools
- > With retractable deburring tool, spare cutting wheel in handle

- > Body in pressure-cast magnesium
- > Enamelled blue



∅ mm	Wall thickness	l mm	kg	Code	No.
3-35	0,7-2,0	160	0.335	2964031	2250 3

### E-2250 SPARE PARTS

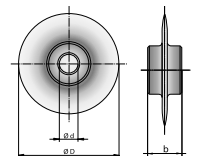

Description	∅ D	b	∅ d	kg	Code	No.
<b>Cutting wheel for 2250 3</b>	20	5.1	4.8	0.005	2964058	E-2250 3 A
<b>Wheel bolt for 2180 3, 2180 4, 2250 3</b>				0.002	2964112	E-2180 3 B

### 2300 PIPE CUTTER QUICK AUTOMATIC

- > Body in pressure-cast zinc
- > For copper, brass, and light-alloy pipes, PVC hard plastic and plastic-coated pipes, thin-walled steel pipes, (precision steel and hydraulic pipes), composite pipes

- > With automatic infeed by plate springs, retractable deburring knife
- > Enamelled blue

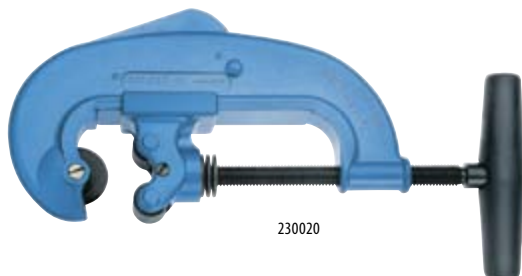

230010

230020

∅ mm	Wall thickness	l mm	kg	Code	No.
4-32	0,7-3,0	165	0.435	4504050	230010
13-65	1,0-7,3	275	1.460	4504130	230020

### E 2300 SPARE PARTS

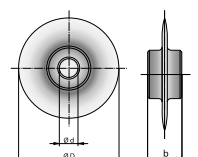

Description	∅ D	b	∅ d	kg	Code	No.
<b>Cutting wheel</b>	20	4.8	5.1	0.005	4504640	230210
<b>Cutting wheel</b>	32	9.9	6.1	0.018	4504800	230220
<b>Wheel bolt</b>				0.003	1154656	230611
<b>Wheel bolt</b>				0.003	1154540	230621

## 2310

### MINIATURE PIPE CUTTER MINI-QUICK

- > Particularly suitable for barely accessible places
- > For copper, brass, and light-alloy pipes, thin-walled steel pipes (precision steel and hydraulic pipes)
- > Body in pressure-cast zinc
- > Enamelled blue



$\varnothing$ mm	Wall thickness	↳ mm ↲	$\frac{kg}{kg}$	Code	No.
4-16	0,7-3,0	50	0.125	4504560	231000

## E 2310

### SPARE PARTS

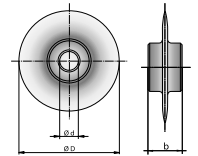

Description	$\varnothing$ D	b	$\varnothing$ d	$\frac{kg}{kg}$	Code	No.
<b>Cutting wheel</b>	20	4.8	5.1	0.005	4504640	230210
<b>Wheel bolt</b>				0.003	1154656	230611

### Pipe Deburring Reamer for copper pipes

### Calibrating Tools for copper pipes

## 2320

### PIPE DEBURRING REAMER

- > For hydraulic and precision steel pipes, copper pipes, as well as pipes in non-ferrous metals
- > For internal and external deburring
- > Plastic body



$\varnothing$ mm	↳ mm ↲	$\frac{kg}{kg}$	Code	No.
4-32	45	0.030	1439510	232001

## 239

### CALIBRATING TOOL

- > For exact calibrating of tube ends
- > For semi-hard and soft copper pipes
- > Gun-metal finish



$\varnothing$ mm	$\frac{kg}{kg}$	Code	No.
12 x 1	0.067	4506340	239012
15 x 1	0.138	4506420	239015
18 x 1	0.179	4506500	239018
22 x 1	0.270	4506690	239022



## Pipe Cutters for plastic pipes

# 2270 PIPE CUTTER

for plastic and composite pipes

- > To cleanly cut multi-layer composite pipes or other plastic pipes
- > Cutting wheel changeable without tools
- > With retractable deburring tool, spare cutting wheel in handle
- > No. 2270 5 with adjustable third pressure roller for optimally guiding different pipe dimensions
- > With quick-release
- > Body in pressure-cast aluminium
- > Enamelled blue



2270 6



2270 5

Ø mm	Wall thickness	l mm	kg	Code	No.
6-76	1,5-8,6	245	0.880	2964015	2270 5
50-127	4,0-19,8	345	1.630	2963957	2270 6

## E-2270 SPARE PARTS

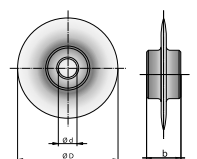

Description	Ø D	b	Ø d	kg	Code	No.
<b>Cutting wheel for 2270 5</b>	30	6.2	4.8	0.008	2964023	E-2270 5 A
<b>Cutting wheel for 2270 6</b>	51	11.0	8.1	0.015	2963973	E-2270 6 A
<b>Wheel bolt for 2180 5, 2270 5</b>				0.005	2964120	E-2180 5 B
<b>Wheel bolt for 2270 6</b>				0.010	2963981	E-2270 6 B

## 2261 SHEARS SET

for plastic pipes

> To cleanly cut hard and soft plastic pipes, rubber hoses with or without textile reinforcement, and as well as various plastic profiled sections, such as cable ducts, for example

> Contains form blocks for 16, 19 and 25 mm pipes, 1 prism for profiles and 1 angle stop adjustable up to 45°  
> Delivery in plastic case



### E 2261 SPARE PARTS

Description		Code	No.
<b>Shear set for plastic pipes</b>	1.050	1637983	226100

Description		Code	No.
<b>Spare knife</b>	0.050	1680137	226005

## 2268 PIPE SHEARS

for plastic pipes

> Suitable to cut PE-, PP-, PB-, PEX-, PPR-, MLP-/MSR-, VPE-, CPVC-, PVC- and PVDF-pipes  
> Can also be used for hoses  
> Smooth and accurate cutting, one hand operation

> Cutting blades changeable without tools  
> Body in pressure-cast magnesium  
> Enamelled blue



### E-2268 SPARE PARTS



Ø mm	l mm		Code	No.
42	245	0.430	2963841	2268 2
63	280	0.610	2963892	2268 3

Description		Code	No.
<b>Spare knife for 2268 2</b>	0.080	2963914	E-2268 2 A
<b>Spare knife for 2268 3</b>	0.160	2963930	E-2268 3 A
<b>Spare bolt for 2268 2 / 3</b>	0.005	2963949	E-2268 B





## Flaring Tools

# 2330 FLARING TOOL BOERDEX

- > For flaring copper and light-alloy pipes of various hardnesses
- > For cooling systems and refrigeration technique
- > Body in pressure-cast zinc, enamelled blue
- > Flange cone 90° hardened = 45° angled from pipe
- > Clamping jaws made from steel, smooth inside, phosphated
- > Opening angle 90° = 45° angled from pipe

Flaring tools for brake lines see no. 1101-2340



Contents	⚖️	Code	No.
for metric pipes 4, 4.75, 6, 8, 10, 12, 14 mm 1 flaring tool No. 233000 1 cone for 180° flaring No. 233200 1 clamping jaw 4-14 mm No. 233101	1.4	4537300	233001
for metric pipes 15, 16, 17, 18, 19 mm 1 flaring tool No. 233000 1 cone for 180° flaring No. 233200 1 clamping jaw 15-19 mm No. 233109	1.4	1919725	233009
for inch pipes 3/16, 1/4, 5/16, 3/8, 7/16, 1/2, 5/8, 3/4" 1 flaring tool No. 233000 1 cone for 180° flaring No. 233200 1 clamping jaw 3/16-3/4" No. 233107	1.5	4554660	233007

Contents	⚖️	Code	No.
for metric pipes 4, 4.75, 6, 8, 10, 12, 14 mm for inch pipes 3/16, 1/4, 5/16, 3/8, 7/16, 1/2, 5/8, 3/4" 1 flaring tool No. 233000 1 cone for 180° flaring No. 233200 1 clamping jaw 4-14 mm No. 233101 1 clamping jaw 3/16-3/4" No. 233107	2.1	2926741	233013
for metric pipes 4, 4.75, 6, 8, 10, 12, 14, 15, 16, 17, 18, 19 mm 1 flaring tool No. 233000 1 cone for 180° flaring No. 233200 1 clamping jaw 4-14 mm No. 233101 1 clamping jaw 15-19 mm No. 233109	2.0	2926768	233014

CONE 90°

CONE 180°

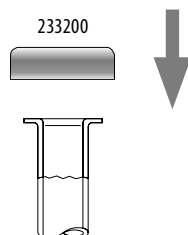
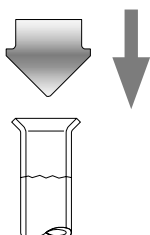

920

>565



# 1101-2333

## FLARING TOOL SET BOERDEX

in i-BOXX® 72

- > For flaring copper and light-alloy pipes of various hardnesses
- > For cooling systems and refrigeration technique
- > Body in pressure-cast zinc, enamelled blue
- > Flange cone 90° hardened = 45° angled from pipe
- > With cone for 180° flaring = 90° angle from pipe
- > Clamping jaws made from steel, smooth inside, phosphated
- > Complete set for metric and metric/inch pipes
- > With pipe cutter 3-35 mm Ø
- > Delivery in GEDORE i-BOXX® 72 no. 1101 L
- > Dimensions: W 367 x D 316 x H 72 mm

Flaring tools for brake lines see no. 1101-2340



Contents	⚖️	Code	No.
for metric pipes 4, 4.75, 6, 8, 10, 12, 14 mm	2.9	4555550	1101-233301
1 flaring tool No. 233000			
1 clamping jaw 4-14 mm No. 233101			
1 pipe cutter 4-32 mm No. 230010			
1 cone 180° No. 233200			
1 sheet steel case No. 233909			
for metric pipes 15, 16, 17, 18, 19 mm	2.9	1919733	1101-233309
1 flaring tool No. 233000			
1 clamping jaw 15-19 mm No. 233109			
1 pipe cutter 4-32 mm No. 230010			
1 cone 180° No. 233200			
1 sheet steel case No. 233909			
for inch pipes 3/16, 1/4, 5/16, 3/8, 7/16, 1/2, 5/8, 3/4"	3.0	4556280	1101-233307
1 flaring tool No. 233000			
1 clamping jaw 3/16-3/4" No. 233107			
1 pipe cutter 4-32 mm No. 230010			
1 cone 180° No. 233200			
1 sheet steel case No. 233909			

Contents	⚖️	Code	No.
for metric pipes 4, 4.75, 6, 8, 10, 12, 14 mm	3.6	2926776	1101-233313
for inch pipes 3/16, 1/4, 5/16, 3/8, 7/16, 1/2, 5/8, 3/4"			
1 flaring tool No. 233000			
1 clamping jaw 4-14 mm No. 233101			
1 clamping jaw 3/16-3/4" No. 233107			
1 pipe cutter 4-32 mm No. 230010			
1 cone 180° No. 233200			
1 sheet steel case No. 233909			
for metric pipes 4, 4.75, 6, 8, 10, 12, 14, 15, 16, 17, 18, 19 mm	3.5	2926784	1101-233314
1 flaring tool No. 233000			
1 clamping jaw 4-14 mm No. 233101			
1 clamping jaw 15-19 mm No. 233109			
1 pipe cutter 4-32 mm No. 230010			
1 cone 180° No. 233200			
1 sheet steel case No. 233909			

## E 233

### PARTS



2331



233200

Description	⚖️	Code	No.
Flaring tool boerdex	0.660	4554150	233000
Clamping jaw 4-14 mm	0.620	4554820	233101
Clamping jaw 15-19 mm	0.560	1885162	233109
Clamping jaw 3/16" - 3/4"	0.680	4555470	233107
Cone for 180° flaring (= 90° angled from pipe)	0.015	4505450	233200
Pipe cutter for copper pipes 3-35 mm	0.335	2964031	2250 3



# 1101-2340 DOUBLE FLARING TOOL SET

in i-BOXX® 72

- > For standard-compliant (DIN 74234) double flaring tools
- > For brake lines, coolant lines, hydraulic and pneumatic pipes with a wall thickness of 0.7 to 1.0 mm
- > Body in tempered cast iron GTW 40, stove enamelled blue
- > Clamping jaws made from steel, smooth inside, phosphated
- > Complete set for metric and/or inch pipes
- > With pipe deburring reamer 4-32 mm Ø and miniature pipe cutter 4-16 mm Ø
- > Delivery in GEDORE i-BOXX® 72 No. 1101 L
- > Dimensions: W 367 x D 316 x H 72 mm



Contents	kg	Code	No.
<b>for metric pipes</b>	3.0	4505530	1101-234001
1 basic frame No. 234000			
1 clamping jaw metric No. 234101			
6 cones 4,75-10 mm No. 234204-234210			
2 cones, No. 234790 + 234801			
1 miniature pipe cutter 4-16 mm No. 231000			
1 pipe deburring reamer 4-32 mm No. 232001			
1 GEDORE i-BOXX® 72 No. 1101 L			

Contents	kg	Code	No.
<b>for metric + inch pipes</b>	4.2	4662980	1101-234013
1 basic frame No. 234000			
2 clamping jaws No. 234101 + 234102			
6 cones 4,75-10 mm No. 234204-234210			
4 cones 3/16-3/8" No. 234303-234306			
3 cones No. 234790 + 234801-802			
1 miniature pipe cutter 4-16 mm No. 231000			
1 pipe deburring reamer 4-32 mm No. 232001			
1 GEDORE i-BOXX® 72 No. 1101 L			

## CONE 90°

## CONE 180°

## FLARE F OPEN

## FLARE E DOUBLE

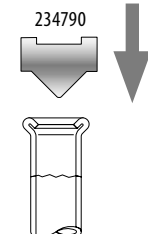
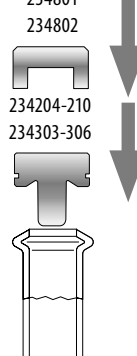
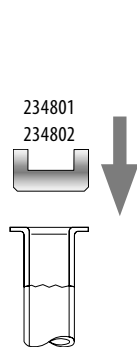
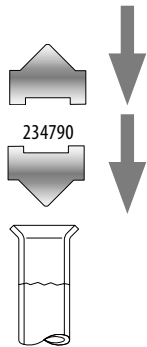

## E 2340 PARTS



Description	kg	Code	No.
<b>Basic frame</b>	0.880	4556440	234000
<b>Clamping jaw metric</b>	0.760	4556520	234101
<b>Clamping jaw inch</b>	0.760	4556600	234102
<b>Cone 4,75 mm for flare types E + F</b>	0.018	4556790	234204
<b>Cone 5 mm for flare types E + F</b>	0.018	4556870	234205
<b>Cone 6 mm for flare types E + F</b>	0.018	4556950	234206
<b>Cone 8 mm for flare types E + F</b>	0.018	4557090	234208
<b>Cone 9 mm for flare types E + F</b>	0.018	4557170	234209
<b>Cone 10 mm for flare types E + F</b>	0.018	4557250	234210
<b>Cone 3/16" for flare types E + F</b>	0.018	4557330	234303
<b>Cone 1/4" for flare types E + F</b>	0.018	4557410	234304

Description	kg	Code	No.
<b>Cone 5/16" for flare types E + F</b>	0.018	4557680	234305
<b>Cone 3/8" for flare types E + F</b>	0.018	4557760	234306
<b>Cone (adjustment gauge) for flare types 90° + 180° and cone 90° + flare E</b>	0.016	4557840	234790
<b>Cone (adjustment gauge), metric, 180°, for flare types E + F</b>	0.011	4557920	234801
<b>Cone (adjustment gauge), inch, 180°, for flare types E + F</b>	0.011	4558060	234802
<b>Pipe cutter MINI-QUICK, 4-16 mm</b>	0.125	4504560	231000
<b>Pipe deburring reamer 4-32 mm</b>	0.030	1439510	232001



## Installation Tools

### 312 VALVE HOLDER VENTI-QUICK

- > In aluminium
- > Drain valve holder and screw-in wrench for eccentric and standard valves 1.1/4"
- > Usable from top or bottom



↳ mm ↲	⚖️	Code	No.
120	0.255	4508980	312000

### 314 CORNER VALVE SOCKET WRENCH

- > Chrome-vanadium steel 31CrV3, hardened, zinc-plated
- > For surface-protective assembling of all usual corner valves
- > With chamfered driving edges
- > 1/2" internal square drive

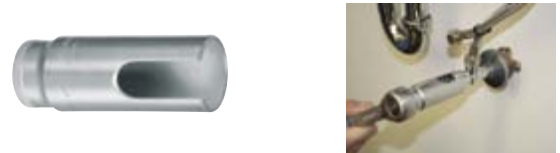

↳ mm ↲	internal Ø	⚖️	Code	No.
82	27	0.150	1147471	314000

### 3170 INSTALLATION WRENCH

- > For washbasin mountings
- > With moveable stud screw insert for bathroom fittings attachment M10 or M12
- > Open end spanner size 17x19 mm for tightening or loosening of corner valves



for stud screws	Size	↳ mm ↲	⚖️	Code	No.
<b>M10</b>	17x19 mm	250	0.330	4509360	317000
<b>M12</b>	17x19 mm	250	0.330	4609310	317012

### 3175 INSTALLATION WRENCH

- > For washbasin mountings
- > With moveable stud screw insert for bathroom fittings attachment M10 or M12
- > With reversible ring ratchet size 17 mm for tightening or loosening of bathroom fittings connections even in hard-to-reach areas
- > Open end spanner size 19 mm for tightening or loosening of corner valves
- > GEDORE vanadium steel 31CrV3, matt chrome-plated



for stud screws	Size	↳ mm ↲	⚖️	Code	No.
<b>M10</b>	17x19 mm	250	0.330	4509520	317500
<b>M12</b>	19x19 mm	250	0.330	4609580	317512

### 3171 STUD SCREW WRENCH

- > For bathroom fittings attachment (stud screws) M6, M8, M10, M12
- > With pivotable thread insert
- > Nickel-plated



↳ mm ↲	⚖️	Code	No.
220	0.300	4509440	317100

### 3173 STUD SCREW INSERTER

- > Self-gripping
- > For the fast and easy insertion and removal of studs, bolts, etc.
- > With hexagon drive



Size	⚖️	Code	No.
<b>M6</b>	0.130	1523171	317306
<b>M8</b>	0.130	1523198	317308
<b>M10</b>	0.130	1523201	317310
<b>M12</b>	0.130	1523228	317312



## 3165 BASIN WRENCH

- > For single lever taps and taps with central screw connection up to size 36 mm
- > With 13 mm hexagon drive and additional adaptors for 9, 10, 11 and 14 mm
- > With pivoted hook for right or left hand operation
- > Enamelled blue

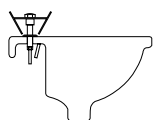

↳ mm	kg	Code	No.
260	0.410	2829274	316500

## 320 WRENCH FOR PLUMBING FITTINGS

- > With pawl clamp
- > With exchangeable plastic jaws no. 320100, width 8 mm
- > For nickel-plated and chrome-plated fittings
- > Chrome-vanadium steel 31CrV3, hardened, chrome-plated
- > Handle enamelled blue



mm	mm	↳ mm	kg	Code	No.
65	45	275	0.720	4509600	320000

Description	kg	Code	No.
Set of plastic jaws	0.010	4540520	320100

## 126 STRAP WRENCH

- > Very gentle to surfaces, particularly suitable for chrome-plated fittings and polished surfaces
- > Handle in light metal, enamelled blue
- > With high-strength nylon strap



Ø mm	Ø inch	↳ mm	mm	kg	Code	No.
220	8	300	27	0.325	1468308	126008

## 329 SPECIAL SIPHON PLIERS

- > For tightening and removing screwed PVC pipe joints with round union nuts
- > With lap joint and three locking positions, jaw width 10 mm
- > No. 329001 with plastic jaws for special surface protection
- > Enamelled blue



329000



329001

Ø mm	↳ mm	kg	Code	No.
20-65	230	0.300	4510290	329000
20-65	230	0.300	1984381	329001

## E 126 SPARE STRAP

- > High-strength nylon strap



↳ mm	mm	kg	Code	No.
950	27	0.035	1468316	126208

## 376 STEPPED KEY

- > For the installation and removal of valve nipples 3/8", 1/2", 3/4", 1", 1.1/4"
- > Drive with 18 mm square
- > Enamelled blue



kg	Code	No.
0.245	4541250	376100

## 380 COMBINATION STEPPED KEY

- > For the installation and removal of radiator valves, runback screwed unions 3/8" - 1" and short tap extensions
- > With pin, hexagon and bi-hexagon nut drive
- > 1/2" square drive
- > Nickel-plated



380200

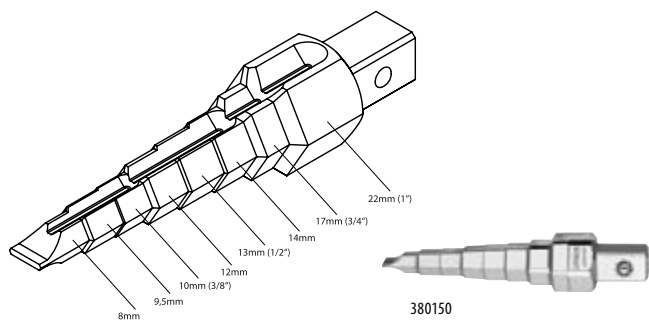

380150

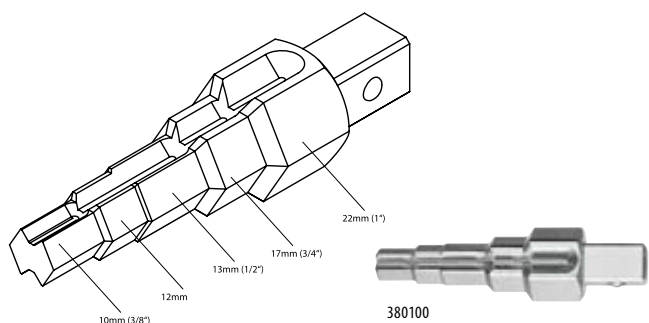

380100

Description	kg	Code	No.
<b>Combi-stepped key No. 380100 with ratchet 1/2" No. 380200</b>	0.555	4512900	380000
<b>Combi-stepped key No. 380150 with ratchet 1/2" No. 380200</b>	0.555	4630940	380001
<b>Combi-stepped key with 5 steps 3/8"-1"</b>	0.135	4513040	380100
<b>Combi-stepped key with 8 steps</b>	0.135	4611130	380150
<b>Ratchet 1/2"</b>	0.420	4513120	380200

## 3785 PLUMBER'S WRENCH

- > With 14 functions for tap extensions 3/8", 1/2", 3/4", 1"
- > Depth up to 100 mm
- > For the installation and removal of radiator valves and runback screwed unions
- > For stud screws M6, M8, M10, M12 and for screw plugs 3/8", 1/2"
- > Hexagon drive nut size 17, 22 mm
- > Chrome-plated

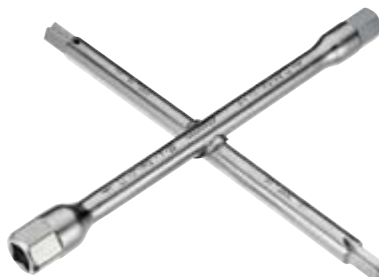

mm	kg	Code	No.
220 x 220	0.670	4512820	378500

## 3810 RADIATOR VALVE SPANNER

- > Spanner for tightening and removing Euro-cone radiator compression fittings with A/F 30 mm cam lock and hex nuts
- > Short, flat version with ratchet
- > Ratchet facilitates tightening of straight and elbow compression fittings underneath radiators
- > Head end socket for 1/2" extension. The extension is used as a handle and also provides higher torque
- > Side socket for 1/2" extension for working with the ratchet in front of the radiator
- > Socket for no. 3801 combination stepped key 3/4" radiator valve nipples
- > DBGM (= German Utility Patent)



381000



381030



Description	kg	Code	No.
<b>Radiator valve spanner no. 381030 with extension 1/2" no. 1990-5</b>	0.390	2233673	381000
<b>Radiator valve spanner 30 mm</b>	0.225	2233665	381030
<b>Extension 1/2" 125 mm</b>	0.188	6143860	1990-5







# BENDING SYSTEMS

## HOW DO I FIND THE RIGHT BENDING TOOL

>615



## PIPE BENDING PLIERS

NO. 2415

>618



## MANUAL PIPE BENDER - DRAW BENDING OPERATION

>619



## MANUAL BENDING TOOL SETS NO. 243

>619



## MANUAL BENDING TOOL SETS NO. 278

>620



## UNIVERSAL MANUAL PIPE BENDER NO. 276

>624



## MANUAL PIPE BENDER - PUSHING BENDING OPERATION NO. 2456

>625



## PIPE BENDING MACHINES - DRAW BENDING OPERATION

>627



## PIPE BENDING MACHINES - PUSHING BENDING OPERATION NO. 256-261

>630



## PIPE BENDING MACHINES HYDRAULIC

>633



## ECCENTRIC ANGLE BENDERS

NO. 280

>635



# TOP QUALITY TO MEET MAXIMUM REQUIREMENTS

- › Use of the most up-to-date machinery and environmentally-friendly production processes
- › Everything is based on tightly controlled and selected materials
- › Experienced and reliable specialists vouch for precision-like processing
- › Stringent quality checks after each production step ensure a constantly high level
- › High-grade industrial quality for the toughest forms of continuous use and safety in everyday work



## Everything handled down to a tee

- › The absence of Chrome 6 in the tools is simply a matter of course for us and has been so for many years.
- › Best-possible results are down to the unique manufacturing processes and special treatment for tools



## GEDORE Pipe bending systems

### Advantages and benefits

#### Features that make the difference ...

- › Durable quality for heavy professional use
- › Gentle handling of workpieces
- › Suitable for solving problems, a variety of materials and applications
- › From simple bending pliers to an electro-hydraulic bending machine for 4" pipes
- › Hand-operated, hydraulic and electro-hydraulic
- › For the complete range of standard pipe grades

### Pipe materials

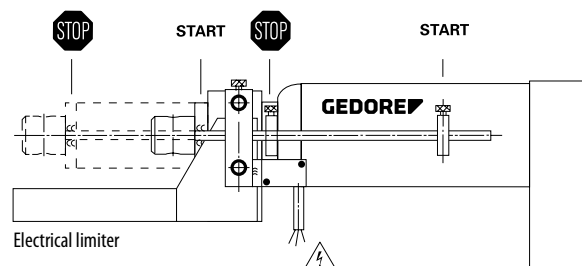

Solving problems is our strength - Please ask us!

# USEFUL INFORMATION

How do I find the right bending tool?

**You need to consider the following points when choosing your bending machine:**

- > Do you want to bend by hand?
- > Do you want to use a vice?
- > Is the machine to be hydraulically operated?
- > Is the machine to be electrically operated, and if so at what voltage?

**The following points also need to be taken into account; refer to adjacent sketch:**

- > The shape of the pipe to be bent (round-section, square-section, etc.)
- > The outside diameter "D" of the pipe
- > The wall thickness "S" of the pipe
- > The pipe grade (e.g. steel, stainless steel, NF metals, etc.)
- > The required bending angle (e.g. 90°, 180° ... etc.)
- > Are bending radii "R" specified? (Example:  $3 \times D = R$  - this corresponds to a 25 mm outside diameter pipe with a bending radius of 75 mm)
- > Important: the radius is measured to the middle of the tube = neutral area
- > Details of the length "L" of the overall pipe
- > Are a number of bends to be made in succession? - If so, it is essential to state the distance between the pipe bends, "L2"
- > Are there any specifications for the pipe or the finished pipe bends which go beyond the details listed here (e.g. in power-station construction, the food industry or similar)?
- > A more detailed overview of the possible uses of our pipe bending machines and tools is given in the next pages.

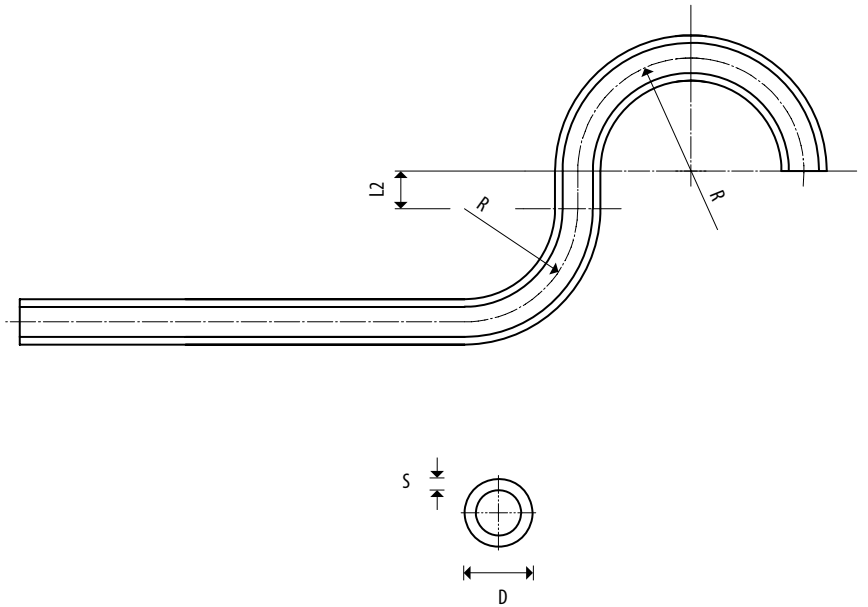

**Fragebogen für Biegemaschinen**

**Bitte auch:**  Handzeichnung  Maßstab

Name: \_\_\_\_\_  
Abteilungsleiter: \_\_\_\_\_  
Werk: \_\_\_\_\_  
Land: PLZ / OR: \_\_\_\_\_  
Tel./Fax: \_\_\_\_\_  
Email: \_\_\_\_\_  
Datum: \_\_\_\_\_

Zur Ergebnisübermittlung bitten wir Ihre Einzelstücke geeigneter Stützgerüste herzustellen und folgende Angaben beizubehalten:

**1. Art des Gestirns**

Wie soll das Gestirn eingestrichelt werden?  
[ ] gestrichelt (z.B. Wasserstrahlstrich) [ ] glatt (z.B. Sandstrahlstrich)  
Ist ein geeigneter Schutzblech vorhanden?  
[ ] ja [ ] nein  
Ist eine abschließende Wälzlack vorhanden?  
[ ] ja [ ] nein  
Wann ist ein möglicher Abschlußtermin?  
[ ] 2017/10/12  
[ ] 2018/01/15  
[ ] 2018/01/15 bis  
Wie viele Bögen sollen hergestellt werden?  
[ ] Stück / Woche [ ] Stück / Monat

Spezielle Anforderungen an das Gestirn aus Gewichte- oder Platzbeschränkungen, Material, Spindelmechanik, Einsatz einer Wälzlackaufbereitung o.ä.:

Fügen Sie diesen Anfrage bitte technische Zeichnungen oder Maßstäbe bei.  
Anlagen: "Techn. Zeichnung" (falls angegeben)

**2. Angaben zum Material**

**2.1. Name:**

St.	St.	St.	St.	St.	St.	St.	St.	St.	St.	St.
1										
2										
3										
4										
5										

Material: \_\_\_\_\_  
Werkstoff: \_\_\_\_\_  
Form: \_\_\_\_\_

**2.2. Material:**

St.	St.	St.	St.	St.	St.	St.	St.	St.	St.	St.
1										
2										
3										
4										
5										

Material: \_\_\_\_\_  
Werkstoff: \_\_\_\_\_  
Längen: \_\_\_\_\_  
Form: \_\_\_\_\_

**2.3.2. Zeichnung:**

Bitte auch:

Name: \_\_\_\_\_  
Datum: \_\_\_\_\_



# APPLICATIONS OF THE GEDORE PIPE BENDER

Size	Nennweite	Outer diameter mm	Wall thickness	No. 241500 max. 90°	No. 2423... max. 90°	No. 243.../1100-243100 max. 180°	No. 245610 / 1100-245680 max. 90°	No. 245611 / 1100-245681 max. 90°	No. 249... max. 90°	No. 250... max. 90°	No. 256... max. 90°	No. 257... / 258... max. 90°	No. 259... / 260... max. 90°	No. 261... max. 90°	No. 276... max. 180°	No. 2785... / 1101-278501 max. 180°	No. 2786... / 1100-278601 max. 180°	No. 2787... max. 180°	No. 1100-278801 max. 180°	
<b>Gas and water pipes EN 10255-M</b>																				
3/8"	DN 10	17,2 mm	2,35 mm						•		•	•	•		•					
1/2"	DN 15	21,3 mm	2,65 mm						•	•	•	•	•		•					
3/4"	DN 20	26,9 mm	2,65 mm						•	•	•	•	•		•					
1"	DN 25	33,7 mm	3,25 mm						•	•	•	•	•	•						
1.1/4"	DN 32	42,4 mm	3,25 mm						•	•	•	•	•	•						
1.1/2"	DN 40	48,3 mm	3,25 mm						•	•		•	•	•						
2"	DN 50	60,3 mm	3,65 mm									•	•	•						
2.1/2"	DN 65	76,1 mm	3,65 mm										•	•						
3"	DN 80	88,9 mm	4,05 mm										•	•						
4"	DN 100	114,3 mm	4,50 mm											•						
<b>Gas and water pipes EN 10255-H</b>																				
3/8"	DN 10	17,2 mm	2,90 mm						•		•	•	•		•					
1/2"	DN 15	21,3 mm	3,25 mm						•	•	•	•	•		•					
3/4"	DN 20	26,9 mm	3,25 mm						•	•	•	•	•		•					
1"	DN 25	33,7 mm	4,05 mm							•	•	•	•	•						
1.1/4"	DN 32	42,4 mm	4,05 mm							•	•	•	•	•						
1.1/2"	DN 40	48,3 mm	4,05 mm							•		•	•	•						
2"	DN 50	60,3 mm	4,50 mm									•	•	•						
2.1/2"	DN 65	76,1 mm	4,50 mm										•	•						
3"	DN 80	88,9 mm	4,85 mm										•	•						
4"	DN 100	114,3 mm	5,40 mm											•						
<b>Distilling pipes EN 10220, metric steel pipes</b>																				
3/8"	DN 10	17,2 mm	≥ 1,80 mm						•											
		20,0 mm	≥ 2,00 mm						•		•	•	•		•					
1/2"	DN 15	21,3 mm	≥ 2,00 mm						•	•	•	•	•							
		22,0 mm	≥ 2,00 mm						•		•	•	•		•					
		25,0 mm	≥ 2,00 mm						•	•	•	•	•	•	•					
3/4"	DN 20	26,9 mm	≥ 2,30 mm						•	•	•	•	•							
		28,0 mm	≥ 2,60 mm						•	•	•	•	•	•	•					
		30,0 mm	≥ 2,60 mm							•	•	•	•	•	•	•				
		32,0 mm	≥ 2,60 mm							•	•	•	•	•	•					
1"	DN 25	33,7 mm	≥ 2,60 mm						•	•	•	•	•	•						
		38,0 mm	≥ 2,60 mm						•	•		•	•	•						
		42,0 mm	≥ 2,60 mm						•	•		•	•	•						
1.1/4"	DN 32	42,4 mm	≥ 2,60 mm						•	•		•	•	•						
		44,5 mm	≥ 2,60 mm									•	•	•						
1.1/2"	DN 40	48,3 mm	≥ 2,60 mm						•	•		•	•	•						
2"	DN 50	60,3 mm	≥ 2,90 mm							•			•	•						
2.1/2"	DN 65	76,1 mm	≥ 2,90 mm										•	•						

depending on size / finish / pipe properties

Size	Nominal size	Outer diameter mm	Wall thickness	No. 241500 max. 90°	No. 2423... max. 90°	No. 243.../1100-243100 max. 180°	No. 245610/1100-245680 max. 90°	No. 245611/1100-245681 max. 90°	No. 249... max. 90°	No. 250... max. 90°	No. 256... max. 90°	No. 257.../258... max. 90°	No. 259.../260... max. 90°	No. 261... max. 90°	No. 276... max. 180°	No. 2785.../1101-278501 max. 180°	No. 2786.../1100-278601 max. 180°	No. 2787... max. 180°	No. 1100-278801 max. 180°
<b>Electrical installation pipes EN 60423</b>																			
M 12		12,0 mm	≥ 1,00 mm						●						●				
M 16		16,0 mm	≥ 1,00 mm						●						●				
M 20		20,0 mm	≥ 1,00 mm						●						●				
M 25		25,0 mm	≥ 1,20 mm						●	●					●				
M 32		32,0 mm	≥ 1,20 mm						●	●					●				
M 40		40,0 mm	≥ 1,20 mm						●	●									
M 50		50,0 mm	≥ 1,20 mm						●	●									
<b>Banister-rail tubes</b>																			
3/8"	DN 10	17,2 mm	≥ 1,75 mm						●										
1/2"	DN 15	21,3 mm	≥ 1,75 mm						●	●									
3/4"	DN 20	26,9 mm	≥ 2,00 mm						●	●									
1"	DN 25	33,7 mm	≥ 2,00 mm						●	●									
1.1/4"	DN 32	42,4 mm	≥ 2,00 mm						●	●									
1.1/2"	DN 40	48,3 mm	≥ 2,00 mm						●	●									
2"	DN 50	60,3 mm	≥ 2,00 mm							●									
<b>Multi-layer composite pipes</b>																			
		12,0 mm	≥ 1,50 mm		●		●	●	●								●		●
		14,0 mm	≥ 2,00 mm				●	●									●		●
		16,0 mm	≥ 2,00 mm				●	●	●								●		●
		18,0 mm	≥ 2,00 mm		●		●	●	●								●		●
		20,0 mm	≥ 2,00 mm				●	●	●		●	●	●					●	●
		26,0 mm	≥ 3,00 mm																
		32,0 mm	≥ 3,00 mm						●	●	●	●	●	●					
		40,0 mm	≥ 3,50 mm						●	●									
		50,0 mm	≥ 4,00 mm						●	●									
<b>Copper pipes EN 1057 half-hard, Outer diameter mm</b>					12, 15, 18, 22				12-22										
<b>Copper pipes EN 1057 soft, Outer diameter mm</b>				4,75-10	10, 12, 15, 18, 22	6-15	10-22	6-22	12-28						8-22				
<b>Sheathed copper pipes, Outer diameter mm</b>					12, 15, 18, 22		12-22	12-22	12-32						12-22				
<b>Thin-walled NF pipes, Outer diameter mm</b>				4,75-10	10, 12, 15, 18, 22	6-15			12-42	25-60,3					8-32				
<b>Hydraulic pipes EN 10305-1, Outer diameter mm</b>				4,75-6	10, 12, 15, 18	6-12	10-18	6-18	12-42	25-60,3	20-32	20-42	20-42	25-42	8-28	3-10	6-18	20-25	6-25
<b>Precision steel pipes EN 10305-3, Outer diameter mm</b>				4,75-6	10, 12, 15, 18	6-12	10-18	6-18	12-50	25-60,3	20-32	20-44,5	20-44,5	25-44,5	8-28	3-10	6-18	20-25	6-25
<b>Stainless steel pipes EN 10088-3, Outer diameter mm</b>					10, 12, 15, 18			6-18	12-50	25-60,3	20-32	20-44,5	20-44,5	25-44,5	8-28	3-10	6-18	20-25	6-25

depending on size / finish / pipe properties



## Pipe bending pliers

### 2415 PIPE BENDING PLIERS



- > Sizes from 4.75 - 10 mm Ø up to 90°
- > With 2 reversible bending forms 3/16" - 1/4" Ø (4,75 - 6 mm Ø) and 8 - 10 mm Ø
- > For soft copper pipes EN 1057, all non-ferrous metal pipes as well as thin-walled precision steel pipes and brake lines
- > Bright nickel-plated, handles PVC coated



Ø mm	Ø inch	l mm	kg	Code	No.
4,75-10,0	3/16-3/8	260	0.580	1442007	241500

### 2423 PIPE BENDING PLIERS



with roller and plastic slide rail

- > Sizes from 10 to 22 mm Ø, bends up to 90°
- > For bendable steel and stainless steel pipes (up to max. 18 x 1.5 mm) as well as soft (also heat-insulated) and semi-hard copper pipes EN 1057
- > Universal use - by exchanging the roller by the plastic slide rail different pipe qualities can be worked
- > Enamelled blue

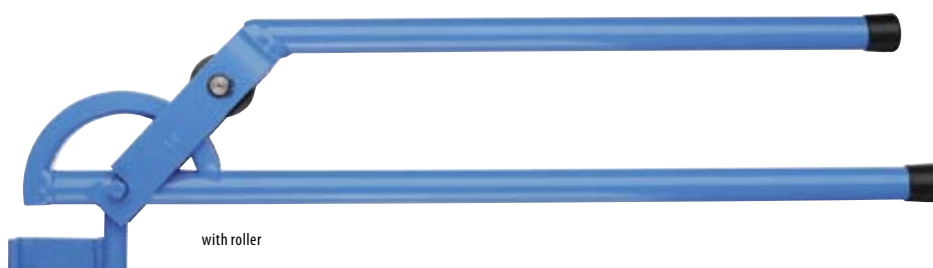

Ø mm	r mm	l mm	kg	Code	No.
10	43	420	1.4	4564890	242310
12	45	420	1.4	4564970	242312
15	60	560	2.1	4565000	242315
18	74	820	2.9	4565190	242318
22	86	820	4.2	4565270	242322

## Manual pipe bender - Draw bending operation

1100-2431  
MANUAL BENDING TOOL SET

in L-BOXX® 136



- > Sizes from 6 to 15 mm Ø, up to 180°
- > For soft copper pipes EN 1057 (also with fixed coating), thin-walled precision steel pipes as well as pipes in non-ferrous metals
- > For clamping in a vice or useable as bending pliers
- > Power-saving due to free selectable initial bending angle
- > Easy bending with reversible ratchet 1/2" in long version
- > Enamelled blue
- > Delivery in GEDORE L-BOXX® 136 no. 1100 L
- > Dimensions: W 442 x D 357 x H 151 mm



Contents	kg	Code	No.
1 bending lever No. 243010	7.4	4568450	1100-243100
1 tool holder no. 243070			
1 reversible ratchet 1/2" no. 1993 U-10 L			
5 bending formers 8, 10, 12, 14, 15 mm			
1 pipe cutter Ø 3-35 mm no. 2250 3			
1 GEDORE L-BOXX® 136 no. 1100 L			

E 243  
PARTSE 243  
BENDING FORMER

Description	kg	Code	No.
<b>Bending lever</b>	0.980	4566320	243010
<b>Tool holder</b>	0.675	2680203	243070
<b>Reversible ratchet 1/2", long 350 mm</b>	0.696	6154550	1993 U-10 L
<b>Pipe cutter for copper pipes 3-35 mm</b>	0.335	2964031	2250 3

Ø mm	r = mm	kg	Code	No.
<b>6,0</b>	28	0.260	4566750	243050
<b>8,0</b>	28	0.250	4566830	243051
<b>10,0</b>	35	0.440	4567050	243053
<b>12,0</b>	35	0.410	4567210	243055
<b>15,0</b>	45	0.650	4567640	243058





# 2785 MANUAL BENDING TOOL SET

INOX FE

- > Sizes from 3 to 10 mm up to 180°
- > For precision steel pipes EN 10305-3 (DIN 2394), hydraulic pipes EN 10305-1 (DIN 2391), and bendable stainless steel pipes with 0.75 - 1.0 mm wall thicknesses
- > With 5 aluminium bending formers for pipes with Ø 3-4, 5, 6, 8 and 10 mm
- > For clamping in a vice or useable as bending pliers



Contents		Code	No.
<b>1 basic tool body no. 278570</b>	1.2	1589830	278500
<b>1 bending lever no. 278581</b>			
<b>5 aluminium bending formers for pipes with Ø 3-4, 5, 6, 8, 10 mm</b>			

# 1101-2785 MANUAL BENDING TOOL SET

INOX FE

in i-BOXX® 72

- > Sizes from 3 to 10 mm up to 180°
- > For precision steel pipes EN 10305-3 (DIN 2394), hydraulic pipes EN 10305-1 (DIN 2391), and bendable stainless steel pipes with 0.75 - 1.0 mm wall thicknesses
- > With 5 aluminium bending formers for pipes with Ø 3-4, 5, 6, 8 and 10 mm
- > For clamping in a vice or useable as bending pliers
- > With pipe cutter no. 231011 and pipe deburring reamer no. 232501
- > Delivery in GEDORE i-BOXX® 72 no. 1101 L
- > Dimensions: W 367 x D 316 x H 72 mm



1101-278501

Contents		Code	No.
<b>1 basic tool body no. 278570</b>	2.4	1589849	1101-278501
<b>1 bending lever no. 278581</b>			
<b>5 aluminium bending formers for pipes with Ø 3-4, 5, 6, 8, 10 mm</b>			
<b>1 miniature pipe cutter Ø 4-16 mm no. 231000</b>			
<b>1 pipe deburring reamer Ø 8-35 no. 232501</b>			
<b>1 GEDORE i-BOXX® 72 no. 1101 L</b>			

## E 2785 PARTS



Description		Code	No.
<b>Basic tool body size 0</b>	0.640	2293625	278570
<b>Bending lever size 0</b>	0.380	2293641	278581
<b>Miniature pipe cutter MINI-QUICK niro</b>	0.125	4554070	231011
<b>Pipe deburring reamer 8-35 mm</b>	0.180	1857681	232501

## E 2785 BENDING FORMER

> From high-quality aluminium



Ø mm	r = mm	Bore mm		Code	No.
<b>3-4</b>	14	16	0.020	1576798	278504
<b>5</b>	16	16	0.025	2963361	278505
<b>6</b>	16	16	0.025	1576801	278506
<b>8</b>	24	16	0.055	1576828	278508
<b>10</b>	29	16	0.085	1576836	278510

# 2786 MANUAL BENDING TOOL SET

INOX FE MT

- > Sizes from 6 to 18 mm up to 180°
- > For precision steel pipes EN 10305-3 (DIN 2394), hydraulic pipes EN 10305-1 (DIN 2391) with 1.0 - 2.0 mm wall thicknesses, composite pipes up to 16 mm as well as bendable stainless steel pipes with 1.0 - 1.5 mm wall thicknesses

- > With 8 bending formers for pipes with Ø 6, 8, 10, 12, 14, 15, 16, 18 mm
- > For clamping in a vice or in combination with tripod no. 268500 for stationary use



Vice not included

Contents	 kg	Code	No.
<b>1 basic tool body no. 278670</b>	5.3	1589857	278600
<b>1 bending lever no. 278681</b>			
<b>8 aluminium bending formers for pipes with Ø 6-8, 10-12, 14, 15, 16, 18 mm</b>			

# 1100-2786 MANUAL BENDING TOOL SET

INOX FE MT

in L-BOXX® 136

- > Sizes from 6 to 18 mm up to 180°
- > For precision steel pipes EN 10305-3 (DIN 2394), hydraulic pipes EN 10305-1 (DIN 2391) with 1.0 - 2.0 mm wall thicknesses, composite pipes up to 16 mm as well as bendable stainless steel pipes with 1.0 - 1.5 mm wall thicknesses
- > With 8 bending formers for pipes with Ø 6, 8, 10, 12, 14, 15, 16, 18 mm
- > For clamping in a vice or in combination with tripod no. 268500 for stationary use
- > With pipe cutter no. 2180 3
- > Delivery in GEDORE L-BOXX® 136 no. 1100 L
- > Dimensions: W 442 x D 357 x H 151 mm



Contents	 kg	Code	No.
<b>1 basic tool body no. 278670</b>	8.3	1611526	1100-278601
<b>1 bending lever pluggable no. 278680</b>			
<b>8 aluminium bending formers for pipes with Ø 6-8, 10-12, 14, 15, 16, 18 mm</b>			
<b>1 pipe cutter Ø 3-35 mm no. 2180 3</b>			
<b>1 pin punch 3 mm</b>			
<b>1 GEDORE L-BOXX® 136 no. 1100 L</b>			



# 1100-2788 MANUAL BENDING TOOL SET



in L-BOXX® 136

- > Sizes from 3 to 10 mm up to 180°
- > For precision steel pipes EN 10305-3 (DIN 2394), hydraulic pipes EN 10305-1 (DIN 2391) with 0.75 - 2.0 mm wall thicknesses, composite pipes up to 16 mm as well as bendable stainless steel pipes with 1.0 - 1.5 mm wall thicknesses
- > With 10 aluminium bending formers for pipes with Ø 3-4, 5, 6, 8, 10, 12, 14, 15, 16 and 18 mm
- > For clamping in a vice
- > Can be used as bending pliers up to size 10 mm
- > As from sizes 12 mm also for stationary use with tripod no. 268500
- > With pipe cutter no. 2180 3
- > Delivery in GEDORE L-BOXX® 136 no. 1100 L
- > Dimensions: W 442 x D 357 x H 151 mm



Contents

- 1 basic tool body 3-18 mm no. 278570
- 1 bending lever 3-18 mm no. 278581
- 1 basic tool body 6-18 mm no. 278670
- 1 bending lever 6-18 mm pluggable no. 278680
- 10 aluminium bending formers for pipes with Ø 3-4, 5, 6, 8, 10, 12, 14, 15, 16, 18 mm
- 1 pipe cutter Ø 3-35 mm no. 2180 3
- 1 pin punch 3 mm
- 1 GEDORE L-BOXX® 136 no. 1100 L



8.7

Code

2963515

No.

1100-278801

## E 2786 PARTS

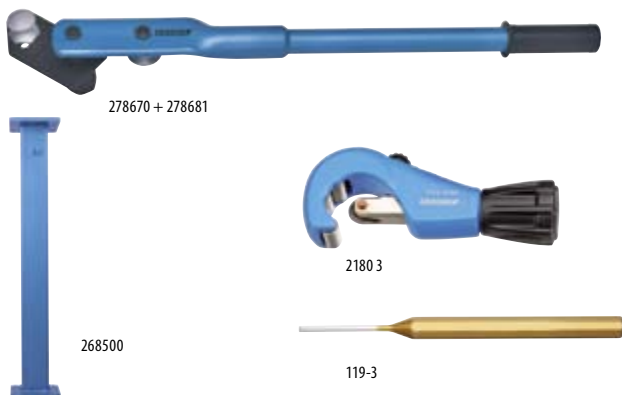

## E 2786 BENDING FORMER

> From high-quality aluminium



Description	kg	Code	No.
<b>Basic tool body size 1</b>	1.2	1677209	278670
<b>Bending lever size 1</b>	2.3	2293692	278681
<b>Bending lever size 1 pluggable</b>	1.9	1626043	278680
<b>Tripod</b>	21.2	2681072	268500
<b>Pipe cutter for stainless steel pipes 3-35 mm</b>	0.3	2964066	2180 3
<b>Pin punch 3 mm</b>	0.1	8758800	119-3

Ø mm	r = mm	Bore mm	kg	Code	No.
<b>6</b>	32	30	0.200	2963442	278606
<b>8</b>	32	30	0.200	1576844	278608
<b>10</b>	36	30	0.220	2963450	278610
<b>12</b>	36	30	0.220	1576852	278612
<b>14</b>	36	30	0.200	1576879	278614
<b>15</b>	43	30	0.320	1576887	278615
<b>16</b>	43	30	0.320	1576895	278616
<b>18</b>	50	30	0.450	1576909	278618

# 2787

## MANUAL BENDING TOOL SET

INOX FE MT

- > Sizes from 20 to 25 mm up to 180°
- > For precision steel pipes EN 10305-3 (DIN 2394), hydraulic pipes EN 10305-1 (DIN 2391) with 1.5 - 2.5 mm wall thicknesses, composite pipes up to 25 mm as well as bendable stainless steel pipes with 1.5 - 2.0 mm wall thicknesses
- > For clamping in a vice
- > With 3 aluminium bending formers for pipes with  $\varnothing$  20, 22, 25 mm
- > Enamelled blue, with black plastic handles



Vice not included

Contents	kg	Code	No.
<b>1 basic tool body no. 278770</b>	13.0	1589865	278700
<b>1 bending lever no. 278781</b>			
<b>3 aluminium bending formers for pipes with <math>\varnothing</math> 20, 22, 25 mm</b>			

## E 2787

### PARTS



278770 + 278781



268500

## E 2787

### BENDING FORMER

- > From high-quality aluminium



Description	kg	Code	No.	$\varnothing$ mm	r = mm	Bore mm	kg	Code	No.
<b>Basic tool body size 2</b>	4.1	2293706	278770	<b>20</b>	85	42	2.0	1576917	278720
<b>Bending lever size 2</b>	3.0	2293722	278781	<b>22</b>	85	42	2.0	1576925	278722
<b>Tripod</b>	21.2	2681072	268500	<b>25</b>	85	42	2.0	1576933	278725



# 276 UNIVERSAL PIPE BENDER



- > Sizes from 8 to 32 mm Ø and 3/8 to 3/4" up to 180°
- > For semi-hard and soft copper pipes EN 1057 up to 22 mm Ø, stainless steel pipes EN 10088-3 (DIN 17 440) up to 28 x 1.5 mm, hydraulic pipes EN 10305-1 (DIN 2391) and precision steel pipes EN 10305-3 (DIN 2394) up to 28 mm, electrical installation pipes EN 60423 up to M 32, composite pipes up to 32 mm, non-ferrous metal pipes and insulated pipes as well as gas and water pipes EN 10255 (DIN 2440/2441) up to 3/4"
- > For use in a vice or installation on the workbench
- > Set up for connecting to a length and angle stop as well as bending lever extension possible (not included)
- > Enamelled blue



276001



280130

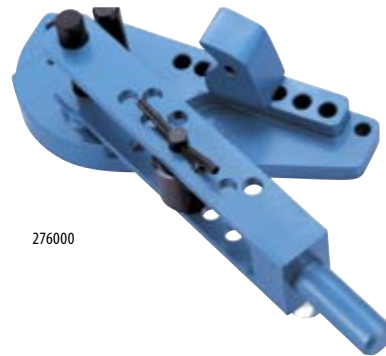

276000



268500

Description	kg	Code	No.
<b>Basic equipment with bending lever extension no. 268230, without bending tools</b>	16.7	4600010	276000
<b>Angled stop</b>	1.8	4600280	276001
<b>Length stop</b>	0.7	4606210	280130
<b>Tripod, height 990 mm</b>	21.2	2681072	268500

## E 276 BENDING TOOLS

- > No. 276508-276532: Bending former with aluminium slide rail for metric pipes
- > No. 276103-276107: Bending former for gas and water pipes EN 10255 (DIN 2440/2441), use with

pressure roller no. 276003 (3/8-3/4")



2765



2761



276003

Description	Ø mm	Size	r = mm	Electrical installation ducts EN 60423	kg	Code	No.
<b>Bending former with slide rail 8 mm</b>	8,0		40		1.4	4601090	276508
<b>Bending former with slide rail 10 mm</b>	10,0		40		1.4	4601170	276510
<b>Bending former with slide rail 12 mm</b>	12,0		40		1.4	4601250	276512
<b>Bending former with slide rail 14 mm</b>	14,0		50		1.9	4601330	276514
<b>Bending former with slide rail 15 mm</b>	15,0		50		1.8	4601410	276515
<b>Bending former with slide rail 16 mm</b>	16,0		68		4.7	4601680	276516
<b>Bending former 3/8"</b>	17,2	3/8	50		1.6	4600600	276103
<b>Bending former with slide rail 18 mm</b>	18,0		68		4.7	4601760	276518
<b>Bending former with slide rail 20 mm</b>	20,0		68		4.6	4601920	276520
<b>Bending former 1/2"</b>	21,3	1/2	68		2.4	4600790	276105
<b>Bending former with slide rail 22 mm</b>	22,0		81		6.5	4602060	276522
<b>Bending former with slide rail 25 mm</b>	25,0		105	M25	4.7	4602140	276525
<b>Bending former 3/4"</b>	26,9	3/4	80		5.8	4600870	276107
<b>Bending former with slide rail 28 mm</b>	28,0		126		5.4	4602300	276528
<b>Bending former with slide rail 30 mm</b>	30,0		153		7.0	4602490	276530
<b>Bending former with slide rail 32 mm</b>	32,0		153	M32	7.0	4602570	276532
<b>Pressure roller</b>		3/8-3/4			0.5	4600360	276003

## Manual pipe bender - Pushing bending operation

### 2456 BENDING TOOL SET

hydraulic

- > Sizes from 10 to 22 mm Ø up to 90°
- > For soft copper pipes EN 1057 up to 22 mm (also heat-insulated), composite pipes up to 20 mm as well as precision steel pipes EN 10305-3 (DIN 2394) up to 18 x 1.5 mm
- > With 7 bending formers for pipes with Ø 10, 12, 14, 15, 18, 20 and 22 mm and corresponding counter-supports
- > Hydraulic drive without great effort
- > Delivery in plastic case no. 245590



Contents	kg	Code	No.
<b>1 base unit, hydraulic no. 245670</b>	6.2	4635230	245610
<b>7 bending tools for pipes with Ø 10, 12, 14, 15, 18, 20, 22 mm</b>			
<b>1 plastic case no. 245590</b>			

### 1100-2456 BENDING TOOL SET

hydraulic, in L-BOXX® 136

- > Sizes from 10 to 22 mm Ø up to 90°
- > For soft copper pipes EN 1057 up to 22 mm (also heat-insulated), composite pipes up to 20 mm as well as precision steel pipes EN 10305-3 (DIN 2394) up to 18 x 1.5 mm
- > With 7 bending formers for pipes with Ø 10, 12, 14, 15, 18, 20 and 22 mm and corresponding counter-supports
- > Hydraulic drive without great effort
- > With pipe cutter no. 2250 3
- > Delivery in GEDORE L-BOXX® 136 no. 1100 L
- > Dimensions: W 442 x D 357 x H 151 mm



Contents	kg	Code	No.
<b>1 base unit, hydraulic no. 245670</b>	6.9	2963531	1100-245680
<b>7 aluminium bending formers for pipes with Ø 10, 12, 14, 15, 18, 20, 22 mm</b>			
<b>3 counter-supports reinforced Ø 6-12, 14-17, 18-22 mm</b>			
<b>1 pipe cutter Ø 3-35 mm no. 2250 3</b>			
<b>1 GEDORE L-BOXX® 136 no. 1100 L</b>			

### 2456 BENDING TOOL SET

hydraulic, heavy-duty

- > Sizes from 6 to 22 mm Ø up to 90°
- > For soft copper pipes EN 1057 up to 22 mm (also heat-insulated), composite pipes up to 20 mm, precision steel pipes EN 10305-3 (DIN 2394) up to 18 x 2 mm, as well as annealed stainless steel pipes up to 18 x 1.2 mm
- > With 10 bending formers for pipes with Ø 6, 8, 10, 12, 14, 15, 16, 18, 20 and 22 mm and corresponding counter-supports
- > Hydraulic drive without great effort
- > In plastic case no. 245690



Contents	kg	Code	No.
<b>1 base unit, hydraulic no. 245670</b>	7.5	1585495	245611
<b>10 bending tools for pipes with Ø 6, 8, 10, 12, 14, 15, 16, 18, 20, 22 mm</b>			
<b>1 plastic case no. 245690</b>			





# 1100-2456 BENDING TOOL SET



hydraulic, heavy-duty, in L-BOXX® 136

- > Sizes from 6 to 22 mm Ø up to 90°
- > For soft copper pipes EN 1057 up to 22 mm (also heat-insulated), composite pipes up to 20 mm, precision steel pipes EN 10305-3 (DIN 2394) up to 18 x 2 mm, as well as annealed stainless steel pipes up to 18 x 1.2 mm
- > With 10 bending formers for pipes with Ø 6, 8, 10, 12, 14, 15, 16, 18, 20 and 22 mm and corresponding counter-supports
- > Hydraulic drive without great effort
- > With pipe cutter no. 2180 3
- > Delivery in GEDORE L-BOXX® 136 no. 1100 L
- > Dimensions: W 442 x D 357 x H 151 mm



Contents	kg	Code	No.
<b>1 base unit, hydraulic no. 245670</b> <b>10 aluminium bending formers for pipes with Ø 6, 8, 10, 12, 14, 15, 16, 18, 20, 22 mm</b> <b>1 counter-support Ø 6-12 mm</b> <b>2 counter-supports reinforced Ø 14-17, 18-22 mm</b> <b>1 pipe cutter Ø 3-35 mm no. 2180 3</b> <b>1 GEDORE L-BOXX® 136 no. 1100 L</b>	8.2	2963558	1100-245681

## E 2456 PARTS

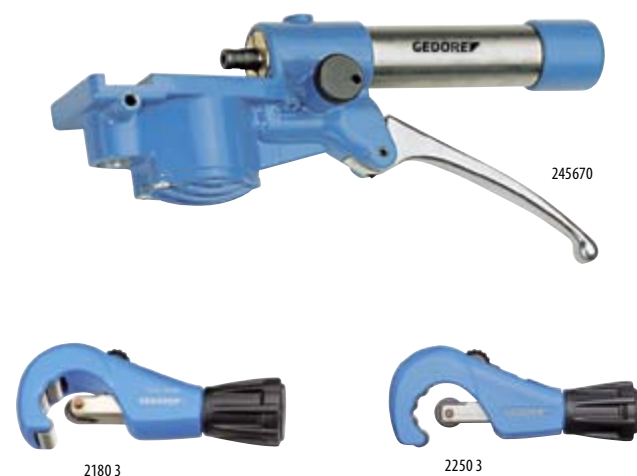

Description	kg	Code	No.
<b>Basic unit, hydraulic</b>	2.350	4635310	245670
<b>Pipe cutter for copper pipes 3-35 mm</b>	0.335	2964031	2250 3
<b>Pipe cutter for stainless steel pipes 3-35 mm</b>	0.335	2964066	2180 3

## E 2457 - E 2458 BENDING TOOLS

- > The counter-support no. 245710-245731 are needed
- > For metric pipes

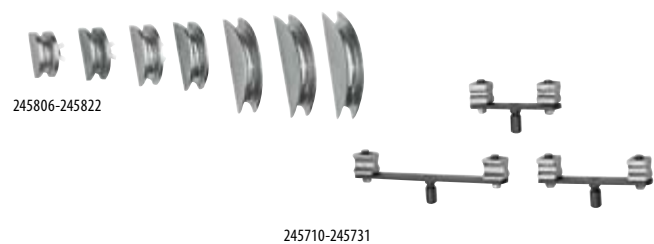

Description	Ø mm	r = mm	kg	Code	No.
<b>Cast aluminium bending former 6 mm</b>	6	31	0.100	4635900	245806
<b>Cast aluminium bending former 8 mm</b>	8	31	0.100	4636040	245808
<b>Cast aluminium bending former 10 mm</b>	10	31	0.100	4636120	245810
<b>Cast aluminium bending former 12 mm</b>	12	34	0.110	4636200	245812
<b>Cast aluminium bending former 14 mm</b>	14	41	0.120	4636390	245814
<b>Cast aluminium bending former 15 mm</b>	15	48	0.140	4636470	245815
<b>Cast aluminium bending former 16 mm</b>	16	49	0.150	4636550	245816
<b>Cast aluminium bending former 18 mm</b>	18	72	0.190	4636710	245818
<b>Cast aluminium bending former 20 mm</b>	20	80	0.200	4636980	245820
<b>Cast aluminium bending former 22 mm</b>	22	88	0.200	4637010	245822
<b>Counter-support 6-12 mm</b>	6-12		0.380	4635580	245710
<b>Counter-support 14-17 mm</b>	14-17		0.460	4635660	245720
<b>Counter-support 14-17 mm reinforced</b>	14-17		0.380	1585509	245721
<b>Counter-support 18-22 mm</b>	18-22		0.460	4635740	245730
<b>Counter-support 18-22 mm reinforced</b>	18-22		0.480	1585517	245731



Pipe bending machines - Draw bending operation

249  
PIPE BENDING MACHINE

manual-hydraulic



- > Sizes from 12 to 50 mm Ø and 3/8" to 1.1/2" up to 90°
- > For copper pipes EN 1057, precision steel pipes EN 10305-3 (DIN 2394) and hydraulic pipes EN 10305-1 (DIN 2391), stainless steel pipes EN 10088-3 (DIN 17 440) up to 42 mm, uncoated pipes and pipes with fixed coating, composite pipes as well as electrical installation pipes EN 60423

- > Pressure 100 kN
- > On pivotable tripod
- > Delivery in wooden assembly case

**Bending tools for further pipe types and sizes available on request**



Contents	kg	Code	No.
<b>1 pump manual-hydraulic no. 254200</b>	76.0	4580150	249000
<b>1 base unit with pivotable tripod no. 249310 without bending tools</b>			

249  
PIPE BENDING MACHINE

electro-hydraulic



- > Sizes from 12 to 50 mm Ø and 3/8" to 1.1/2" up to 90°
- > For copper pipes EN 1057, precision steel pipes EN 10305-3 (DIN 2394) and hydraulic pipes EN 10305-1 (DIN 2391), stainless steel pipes EN 10088-3 (DIN 17 440) up to 42 mm, uncoated pipes and pipes with fixed coating, composite pipes as well as electrical installation pipes EN 60423
- > Electrical limiter for continuous pre-setting and repetition in the production of pipe bends
- > Pressure 100 kN
- > On pivotable tripod
- > Delivery in wooden assembly case

**Bending tools for further pipe types and sizes available on request**



Electrical limiter

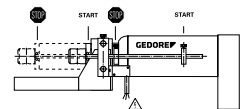

Contents	kg	Code	No.
<b>1 pump electro-hydraulic 380-415 V 50/60 Hz no. 254601</b>	111.0	4580230	249001
<b>1 base unit with pivotable tripod no. 249311 without bending tools</b>			
<b>1 pump electro-hydraulic 230 V 50/60 Hz no. 254651</b>	111.0	1547593	249002
<b>1 base unit with pivotable tripod no. 249311 without bending tools</b>			

254



>633



# E 249

## BENDING TOOLS

- > Consisting of bending former, pipe holder and aluminium slide rail
- > Bending formers, pipe holders and steel bending rails are available on request for shaping stainless steel pipes - chemically nickel plated
- > Special sizes available on request



Ø mm	Size	Electrical installation ducts EN 60423	Precision steel pipes EN 10305-3	Cu pipes EN 1057	r = mm	Code	No.
12,0		M12	12	12	85	1527339	249812
12,7					100	2125242	249605
15,0			15	15	85	4640660	249815
15,88					100	2125250	249606
16,0		M16	16		85	4654290	249816
17,2	3/8				85	1742655	249503
18,0			18	18	85	4654370	249818
19,05					100	2125269	249607
20,0			20		85	4654530	249820
21,3	1/2				100	1639935	249505
22,0			22	22	85	4654610	249822
22,22					150	2125277	249608
25,0			25		85	4582520	249825
25,0		M25	25		100	1546120	249025
25,4					200	2125293	249610
26,9	3/4				100	1422820	249507
28,0			28		85	4582600	249828
28,0			28		100	4580310	249028
30,0			30		85	4582790	249830
30,0			30		100	4580580	249030
31,75					200	2125315	249612
32,0		M32	32		150	1546147	249132
33,7	1				150	1276190	249510
35,0			35		150	4580900	249135
38,0			38		150	4581120	249138
40,0		M40	40		200	1546163	249240
42,0			42		200	1561944	249242
42,4	1.1/4				150	1549561	249512
48,3	1.1/2				200	1232401	249515
50,0		M50	50		200	4581710	249250

# 250

## PIPE BENDING MACHINE

manual-hydraulic

- > Sizes from 25 to 54 mm Ø and 1/2" to 2" up to 180°
- > Especially suitable for thornless bending of thin-walled stainless steel pipes EN 10088-3 (DIN 17 440) over 0.8 mm wall thickness
- > Also for copper pipes EN 1057, precision steel pipes EN 10305-3 (DIN 2394) and hydraulic pipes EN 10305-1 (DIN 2391), NF pipes, uncoated pipes as well as electrical installation pipes EN 60423
- > Pressure 160 kN
- > On pivotable tripod
- > Delivery in wooden assembly case

**Bending tools for further pipe types and sizes available on request**



Contents		Code	No.
1 pump manual-hydraulic no. 254300	155.0	4583760	250000
1 base unit no. 250010			
1 pivotable tripod no. 268001			
without bending tools			

# 250 PIPE BENDING MACHINE

electro-hydraulic



- > Sizes from 25 to 54 mm Ø and 1/2" to 2" up to 180°
- > Especially suitable for thornless bending of thin-walled stainless steel pipes EN 10088-3 (DIN 17 440) over 0.8 mm wall thickness
- > Also for copper pipes EN 1057, precision steel pipes EN 10305-3 (DIN 2394) and hydraulic pipes EN 10305-1 (DIN 2391), NF pipes, uncoated pipes as well as electrical installation pipes EN 60423
- > Electrical limiter for continuous pre-setting and repetition in the production of pipe bends
- > Pressure 160 kN
- > On pivotable tripod
- > Delivery in wooden assembly case



**Bending tools for further pipe types and sizes available on request**

Contents		Code	No.
<b>1 pump electro-hydraulic 380-415 V 50/60 Hz no. 254701</b> <b>1 base unit no. 250010</b> <b>1 pivotable tripod no. 268001</b> <b>without bending tools</b>	175.0	4583840	250001
<b>1 pump electro-hydraulic 230 V 50/60 Hz no. 254751</b> <b>1 base unit no. 250010</b> <b>1 pivotable tripod no. 268001</b> <b>without bending tools</b>	175.0	1380133	250002

# E 250 BENDING SETS

- > Consisting of bending former with aluminium slide rail and pipe holder
- > Bending formers, pipe holders and steel bending rails are available on request for shaping stainless steel pipes - chemically nickel plated
- > Special sizes available on request



Ø mm	Size	Electrical installation ducts EN 60423	Precision steel pipes EN 10305-3	r = mm		Code	No.
12,7				100	3.900	2125242	249605
15,88				100	3.900	2125250	249606
19,05				100	3.900	2125269	249607
21,3	1/2			100	4.000	1639935	249505
22,22				150	7.500	2125277	249608
25,0		M25	25	100	3.940	1546120	249025
25,4				200	12.900	2125293	249610
26,9	3/4			100	6.500	1422820	249507
28,0			28	100	3.520	4580310	249028
30,0			30	100	3.740	4580580	249030
30,0			30	150	13.000	1679155	250330
31,75				200	12.900	2125315	249612
32,0		M32	32	150	7.500	1546147	249132
33,7	1			150	7.500	1276190	249510
35,0			35	150	7.280	4580900	249135
38,0			38	150	7.080	4581120	249138
38,1			250	250	21.000	2125161	250615
40,0		M40	40	200	12.920	1546163	249240
42,0			42	200	13.400	1561944	249242
42,4	1.1/4			150	7.500	1549561	249512
42,4	1.1/4		1.1/4	200	15.000	4655340	250312
44,44				300	31.000	2125188	250617
48,3	1.1/2			200	14.500	1232401	249515
48,3	1.1/2		1.1/2	250	21.000	4655420	250315
50,0		M50	50	200	13.120	4581710	249250
50,8				300	31.000	2125226	250620
52,0			52	350	41.000	4640900	250352
54,0			54	250	21.000	2001152	250354
60,3	2			250	21.000	1148001	250520
60,3	2		2	400	55.000	4655500	250320



Pipe bending machines - Pushing bending operation

MAX. BENDING CAPACITIES PIPE BENDING MACHINES 256-261

Pipe bending machine No.	Gas and water pipes EN 10255 (DIN 2440/2441)	Distilling pipes EN 10220 (DIN 2448)		Metric tubes *)
	up to 90° Size	up to 90° Size	∅ mm	up to 90° ∅ mm
256	3/8 - 1.1/4"	1/2 - 1"	20 - 32	20 - 32
257 - 258	3/8 - 2"	1/2 - 1.1/2"	20 - 44,5	20 - 44,5
259 - 260	3/8 - 3"	1/2 - 2.1/2"	20 - 44,5	20 - 44,5
261	1 - 4"	1 - 2.1/2"	25 - 44,5	25 - 44,5

\*) Specifications under reserve - as these are dependent on the respective wall thickness

256  
PIPE BENDING MACHINE 3/8" - 1.1/4"



- > For gas and water pipes EN 10255 (DIN 2440/2441) up to max. 90°
- > With open bending frame
- > Pressure 60 kN
- > Delivery in assembly case

Available in various designs:

- > - manually or electro-hydraulically operated
- > - as the basic tool without bending former or as a set with bending former no. 263103-112

Optional bending tools under no. 263 - 264 available for:

- > - Distilling pipes EN 10220 (DIN 2448) from 1/2 to 1" or 20 to 32 mm
- > - Metric pipes from 20 to 32 mm

Bending tools for further pipe types and sizes and for stainless steel pipes on request



included in delivery	Ill.	kg	Code	No.
manual-hydraulic, open bending frame, without bending formers	C	47.0	4586860	256000
manual-hydraulic, open bending frame, with 5 bending formers no. 263103-112	C	56.0	4586940	256100
electro-hydraulic 380-415 V 50/60 Hz, open bending frame, without bending formers	D	73.0	4587080	256500
electro-hydraulic 380-415 V 50/60 Hz, open bending frame, with 5 bending formers no. 263103-112	D	82.0	4587160	256510
electro-hydraulic 230 V 50/60 Hz, open bending frame, without bending formers	D	73.0	4587240	256600
electro-hydraulic 230 V 50/60 Hz, open bending frame, with 5 bending formers no. 263103-112	D	82.0	4587320	256610

## 257 - 258

## PIPE BENDING MACHINE 3/8" - 2"

INOX FE

- > For gas and water pipes EN 10255 (DIN 2440/2441) up to max. 90°
- > Pressure 100 kN
- > Delivery in assembly case

**Available in various designs:**

- > - manually or electro-hydraulically operated
- > - with open or fold-open bending frame
- > - as the basic tool without bending former or as a set with bending former no. 263103-120

**Optional bending tools under no. 263 - 264 available for:**

- > - Distilling pipes EN 10220 (DIN 2448) from 1/2 to 1.1/2" or 20 to 44.5 mm
- > - Metric pipes from 20 to 44.5 mm

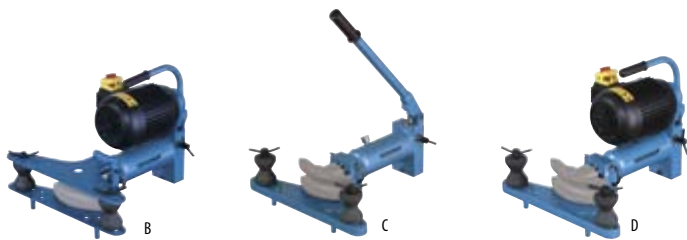
**Bending tools for further pipe types and sizes and for stainless steel pipes on request****MODEL 257:****FOLD-OPEN BENDING FRAME FOR MOBILE USE****MODEL 258:****OPEN BENDING FRAME FOR QUICK AND EFFICIENT WORKING**

included in delivery	III.	kg	Code	No.
manual-hydraulic, fold-open bending frame, without bending formers	A	54.0	4587400	257000
manual-hydraulic, fold-open bending frame, with 7 bending formers no. 263103-120	A	75.0	4587590	257100
electro-hydraulic 380-415 V 50/60 Hz, fold-open bending frame, without bending formers	B	78.0	4587670	257500
electro-hydraulic 380-415 V 50/60 Hz, fold-open bending frame, with 7 bending formers no. 263103-120	B	99.0	4587750	257510
electro-hydraulic 230 V 50/60 Hz, fold-open bending frame, without bending formers	B	78.0	4587830	257600
electro-hydraulic 230 V 50/60 Hz, fold-open bending frame, with 7 bending formers no. 263103-120	B	99.0	4587910	257610
manual-hydraulic, open bending frame, without bending formers	C	73.0	4588050	258000
manual-hydraulic, open bending frame, with 7 bending formers no. 263103-120	C	95.0	4588130	258100
electro-hydraulic 380-415 V 50/60 Hz, open bending frame, without bending formers	D	98.0	4588210	258500
electro-hydraulic 380-415 V 50/60 Hz, open bending frame, with 7 bending formers no. 263103-120	D	119.0	4588480	258510
electro-hydraulic 230 V 50/60 Hz, open bending frame, without bending formers	D	98.0	4588560	258600
electro-hydraulic 230 V 50/60 Hz, open bending frame, with 7 bending formers no. 263103-120	D	119.0	4588640	258610



# 259 - 260

## PIPE BENDING MACHINE 3/8" - 3"



- > For gas and water pipes EN 10255 (DIN 2440/2441) up to max. 90°
- > Pressure 160 kN
- > Delivery in assembly case

**Available in various designs:**

- > - manually or electro-hydraulically operated
- > - with open or fold-open bending frame
- > - as the basic tool without bending former or as a set with bending former no. 263103-130

**Optional bending tools under no. 263 - 264 available for:**

- > - Distilling pipes EN 10220 (DIN 2448) from 1/2 to 2.1/2" or 20 to 44.5 mm
- > - Metric pipes from 20 to 44.5 mm

**Bending tools for further pipe types and sizes and for stainless steel pipes on request**

**MODEL 259:**

**FOLD-OPEN BENDING FRAME FOR MOBILE USE**

**MODEL 260:**

**OPEN BENDING FRAME FOR STATIONARY USE AND QUICK AND EFFICIENT WORKING**



included in delivery	III.	kg	Code	No.
<b>manual-hydraulic, fold-open bending frame, without bending formers</b>	A	98.0	4588720	259000
<b>manual-hydraulic, fold-open bending frame, with 9 bending formers no. 263103-130</b>	A	173.0	4588800	259100
<b>electro-hydraulic 380-415 V 50/60 Hz, fold-open bending frame, without bending formers</b>	B	123.0	4588990	259500
<b>electro-hydraulic 380-415 V 50/60 Hz, fold-open bending frame, with 9 bending formers no. 263103-130</b>	B	198.0	4589020	259510
<b>electro-hydraulic 230 V 50/60 Hz, fold-open bending frame, without bending formers</b>	B	123.0	4589100	259600
<b>electro-hydraulic 230 V 50/60 Hz, fold-open bending frame, with 9 bending formers no. 263103-130</b>	B	198.0	4589290	259610
<b>manual-hydraulic, open bending frame, without bending formers</b>	C	120.0	4589370	260000
<b>manual-hydraulic, open bending frame, with 9 bending formers no. 263103-130</b>	C	207.0	4589450	260100
<b>electro-hydraulic 380-415 V 50/60 Hz, open bending frame, without bending formers</b>	D	155.0	4589530	260500
<b>electro-hydraulic 380-415 V 50/60 Hz, open bending frame, with 9 bending formers no. 263103-130</b>	D	242.0	4589610	260510
<b>electro-hydraulic 230 V 50/60 Hz, open bending frame, without bending formers</b>	D	155.0	4589880	260600
<b>electro-hydraulic 230 V 50/60 Hz, open bending frame, with 9 bending formers no. 263103-130</b>	D	242.0	4589960	260610



## 261 PIPE BENDING MACHINE 1" - 4"

INOX FE

- > For gas and water pipes EN 10255 (DIN 2440/2441) up to max. 90°
- > With fold-open bending frame
- > Pressure 200 kN
- > Delivery in wooden assembly case

### Available in various designs:

- > - manually or electro-hydraulically operated
- > - as the basic tool without bending former or as a set with bending former no. 263113-130, 263040

### Optional bending tools under no. 263 - 264 available for:

- > - Distilling pipes EN 10220 (DIN 2448) from 1" to 2.1/2" or 25 to 44.5 mm
- > - Metric pipes from 25 to 44.5 mm

### Bending tools for further pipe types and sizes and for stainless steel pipes on request

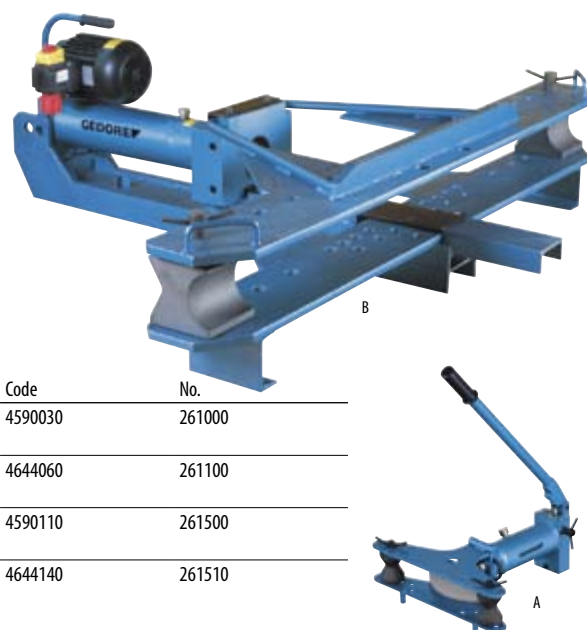

included in delivery	Ill.		Code	No.
<b>manual-hydraulic, fold-open bending frame, without bending formers</b>	A	311.0	4590030	261000
<b>manual-hydraulic, fold-open bending frame, with bending formers no. 263110-130, 263040</b>	A	480.0	4644060	261100
<b>electro-hydraulic 380-415 V 50/60 Hz, fold-open bending frame, without bending formers</b>	B	330.0	4590110	261500
<b>electro-hydraulic 380-415 V 50/60 Hz, fold-open bending frame, with bending formers no. 263110-130, 263040</b>	B	499.0	4644140	261510

## 268 INSTALLATION TRIPOD, PIVOTABLE

- > Available in 2 sizes
- > For GEDORE pipe bender no. 256-260 (standard equipment for benders no. 249 and 250)
- > Enamelled blue

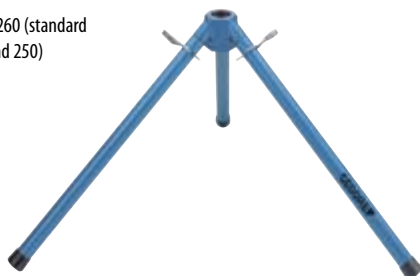

Height	Use		Code	No.
<b>480</b>	for manual-hydraulic benders no. 256, 257, 258	6.2	4599760	268000
<b>680</b>	for manual-hydraulic benders no. 259, 260 and all electric-hydraulic benders	17.4	4599840	268001

## 254 EXTENSION CABLE

- > For electro-hydraulic pumps 1.1/4", 2", 3" and 4"
- > Heavy rubber hose
- > Can be used in dry and damp rooms
- > For high mechanical loads, including construction sites



254983



254985

Description	Connection voltage V		Code	No.
<b>CEE extension cable 10 m</b>	380-415	3.1	4694160	254983
<b>Safety extension cable 10 m</b>	230	1.6	4694320	254985

## 269 HYDRAULIC OIL

1 litre

- > For re-filling all GEDORE hydraulic pumps
- > For filling the volume stated in the table is required



Litre	for pumps	use in machine no.	required volume litre		Code	No.
<b>1</b>	2541, 2545	256	0,90	0.880	4599920	269000
	2542, 2546	249, 257, 258	1,25			
	2543, 2547	250, 259, 260	1,90			
	2544, 2548	261	3,50			

## 2631 GREY CAST IRON BENDING FORMER UP TO 90°

FE

- > For gas and water pipes EN 10255-M (DIN 2440)
- > Enamelled black



Use in machine No.	Size	Ø mm	r = mm	Bore mm		Code	No.
<b>256-260</b>	3/8	17,2	45	35,5	0,9	4539000	263103
<b>256-260</b>	1/2	21,3	50	35,5	1,3	4539190	263105
<b>256-260</b>	3/4	26,9	75	35,5	2,2	4539270	263107
<b>256-261</b>	1	33,7	100	35,5	2,3	4590460	263110
<b>256-261</b>	1.1/4	42,4	115	35,5	2,4	4590540	263112
<b>257-261</b>	1.1/2	48,3	150	35,5	5,3	4539350	263115
<b>257-261</b>	2	60,3	200	35,5	6,7	4539430	263120
<b>259-261</b>	2.1/2	76,1	320	35,5	21,2	4590620	263125
<b>259-261</b>	3	88,9	380	35,5	30,4	4590700	263130





## 2630 STEEL BENDING FORMER UP TO 90°

- > For gas and water pipes EN 10255 (DIN 2440/2441)
- > For surface-protective bending
- > Phosphated



Use in machine No.	Size	Ø mm	r = mm	Bore mm	⚖	Code	No.
<b>256-260</b>	1/2	21,3	50	35,5	1.3	4655850	263005
<b>256-260</b>	3/4	26,9	75	35,5	2.2	4655930	263007
<b>256-261</b>	1	33,7	100	35,5	2.3	4656070	263010
<b>256-261</b>	1.1/4	42,4	126	35,5	5.8	4656150	263012
<b>257-261</b>	1.1/2	48,3	145	35,5	5.3	4656230	263015
<b>257-261</b>	2	60,3	200	35,5	11.2	4656310	263020
<b>259-261</b>	2.1/2	76,1	320	35,5	21.2	4656580	263025
<b>259-261</b>	3	88,9	380	35,5	44.5	4656660	263030
<b>261</b>	4	114,3	600	35,5	98.0	4644300	263040

## 2640 STEEL BENDING FORMER UP TO 90°

INOX FE

- > For standard-walled distilling pipes EN 10220 (DIN 2448) and metric pipes
- > Phosphated

Bending tools for further pipe types and sizes and for stainless steel pipes on request



Use in machine No.	Size	Ø mm	r = mm	Bore mm	⚖	Code	No.
<b>256-260</b>		20,0	90	35,5	3.4	4593130	264020
<b>256-260</b>	1/2	21,3	75	35,5	2.5	4595340	264005
<b>256-260</b>		22,0	90	35,5	3.2	4593210	264022
<b>256-261</b>		25,0	115	35,5	3.6	4595770	264025
<b>256-260</b>	3/4	26,9	90	35,5	3.5	4595420	264007
<b>256-261</b>		28,0	130	35,5	5.4	2910438	264028
<b>256-261</b>		30,0	140	35,5	6.7	4595850	264030
<b>256-261</b>		32,0	140	35,5	6.6	4595930	264032
<b>256-261</b>	1	33,7	130	35,5	5.4	4595500	264010
<b>257-261</b>		38,0	170	35,5	8.2	4596070	264038
<b>257-261</b>		42,0	190	35,5	10.7	2910446	264042
<b>257-261</b>	1.1/4	42,4	180	35,5	10.2	4595690	264012
<b>257-261</b>		44,5	190	35,5	10.7	4596150	264044
<b>257-261</b>	1.1/2	48,3	220	35,5	11.8	4596230	264048
<b>259-261</b>	2	60,3	270	35,5	21.3	4596660	264060
<b>259-261</b>	2.1/2	76,1	420	35,5	49.3	4596900	264076

### Eccentric angle benders

## MAX. BENDING CAPACITIES ANGLE BENDERS NO. 280

	70 mm working height		100 mm working height		120 mm working height	
	cold mm	hot mm	cold mm	hot mm	cold mm	hot mm
Flat steel EN 10058 (DIN 1017) (material strength 370 N/mm <sup>2</sup> )	70 x 6 (70 x 10)* (50 x 15)* (30 x 20)*	70 x 10 (70 x 20)* (50 x 25)*	100 x 10 80 x 12 50 x 15 30 x 20	100 x 20 80 x 25	120 x 8 100 x 10 80 x 12 50 x 15 30 x 20	120 x 20 80 x 25
Square steel stock EN 10059 (DIN 1014) (material strength 370 N/mm <sup>2</sup> )	6 (22)*	10 (30)*	22	30	22	30
Round steel stock EN 10060 (DIN 1013) (material strength 370 N/mm <sup>2</sup> )	6 (25)*	10 (30)*	25	30	25	30
Angled steel stock EN 10056-1 (DIN 1028) (material strength 370 N/mm <sup>2</sup> )	70 x 6	70 x 9	100 x 10	100 x 12	120 x 10	120 x 15
CU-flat bars EN 13601 (material strength 250 N/mm <sup>2</sup> )	60 x 6 (60 x 30)*		100 x 30		120 x 10 100 x 30	
AL-flat bars EN 754-5 (DIN 1769) (material strength 160 N/mm <sup>2</sup> )	70 x 10 (70 x 30)*		100 x 30		120 x 15 100 x 30	

\* optional bending tool no. 280072 is necessary

# 280 ECCENTRIC ANGLE BENDER

70, 100 and 120 mm working height

- > For round, flat and angled stocks in steel, copper or aluminium up to 90°
- > With stepless adjustable angle stop
- > With length stop
- > Manual base unit for mounting on a workbench, with optional tripod no. 268500 for stationary use
- > With optional available angle no. 280250 for vice fixture
- > Optionally available are bending tools for a diversity of applications - see E 280 bending tools

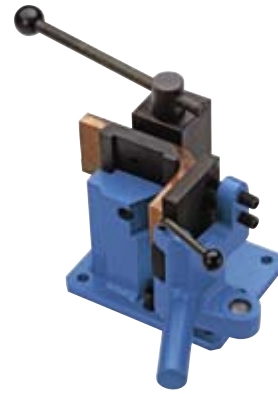

Included in delivery		Code	No.
Basic tool 70 mm working height, manual, with bending lever extension no. 268230	29.5	4539940	280070
Basic tool 100 mm working height, manual, with bending lever extension no. 268230	32.5	4535010	280100
Basic tool 120 mm working height, manual, with bending lever extension no. 268230	34.1	4606130	280120

## E 280 BENDING TOOLS



280072



280113  
280114

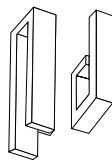

280115

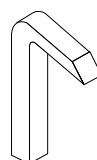

280116

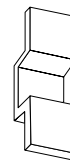

280117

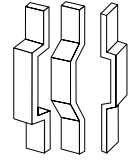

Description	use in machine no.		Code	No.
Radiused bending tool $r = 15 \text{ mm}$ / $r = 25 \text{ mm}$ for material thicknesses up to 30 mm	280070	1.1	4605320	280072
Bending tool for producing saddles and rectangular bends, sharp-edged for material thicknesses up to 3 mm	280100	0.8	4605670	280113
Bending tool for producing saddles and rectangular bends, $r = 4 \text{ mm}$ for material thicknesses up to 6 mm	280100	0.9	4605750	280114
Bending tool for making diamond bends	280070, 280100, 280120	0.7	4605830	280115
Bending tool for high saddles	280100	1.2	4605910	280116
Offset block for narrow saddles	280100	2.4	4606050	280117

## E 280 ACCESSORIES



280250

268500



411-150

>554



Description		Code	No.
Tripod, height 990 mm	21.2	2681072	268500
Angle for vice fixture	3.3	2009544	280250



# WE GIVE YOU THE SECURITY YOU NEED

## Factory calibration - solid reliability!

- > Indirect traceability to the national standard
- > Factory calibration according to the standard DIN EN ISO 6789:2003
- > Factory calibration if necessary with adjustments and repairs - for GEDORE products only
- > Factory test certificate and calibration stamp

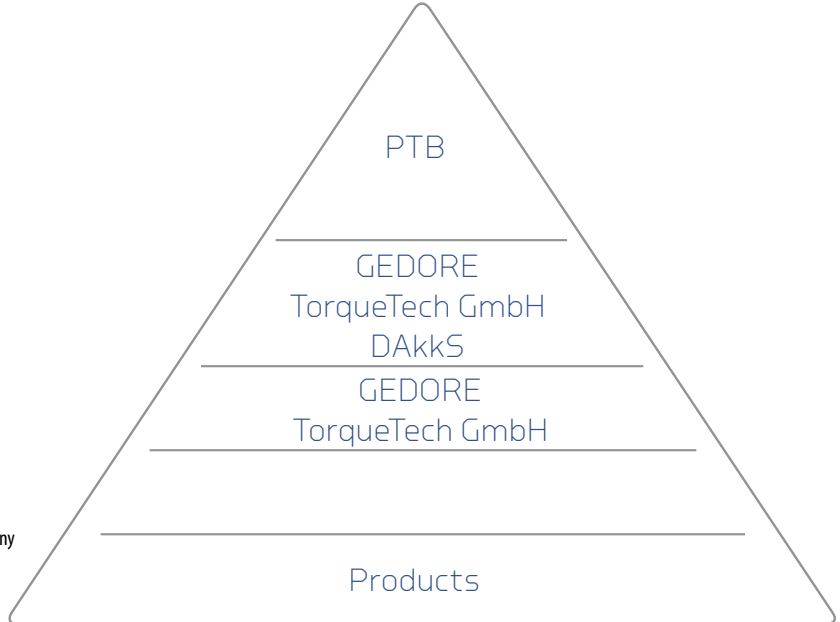

## Factory test certificate according to DIN EN ISO 6789:2003

- > It contains information about the test item, measurement results, the test equipment used and the classification of the test item according to DIN EN ISO 6789:2003 (e.g. Type II Class A).
- > The calibration is carried out on test equipment, which comply with the DIN EN ISO 6789:2003.
- > The calibration result of the factory certificate does not take consideration of any measurement inaccuracies by test equipment at individual hierarchy steps.
- > The documented measuring inaccuracies refers only to the test item.



## Factory Calibration

### Test subject

Mech. torque wrench		0,2-1.000 N·m
Electr. torque wrench		0,2-3.000 N·m
> Torque testers		0,2-3.000 N·m

### Test device

### Test result

DIN EN ISO 6789

### Note

Calibration always represents a snapshot! Within the framework of calibration, deviations in measurements and measurement inaccuracies are recorded on a certain date and documented accordingly in the calibration certificate. Using these calibration results, a statement can be made as regards tolerance accuracy since the previous calibration. No statement can however be made as regards future performance.

If you have any queries, simply call our service hotline:

**+49 (0) 1804 37 36 68**

The generation of a factory test certificate in accordance with GEDORE criteria as well as adjustment and repair is exclusively possible for torque wrenches and test equipment manufactured by us.

Factory and DAkkS calibrations involve right calibration. Left calibration also available on request.

Depending on the requirements or customer requests, we calibrate in accordance with DAkkS guidelines or GEDORE criteria

# DAkKS CALIBRATION - 100 % DOCUMENTED SAFETY

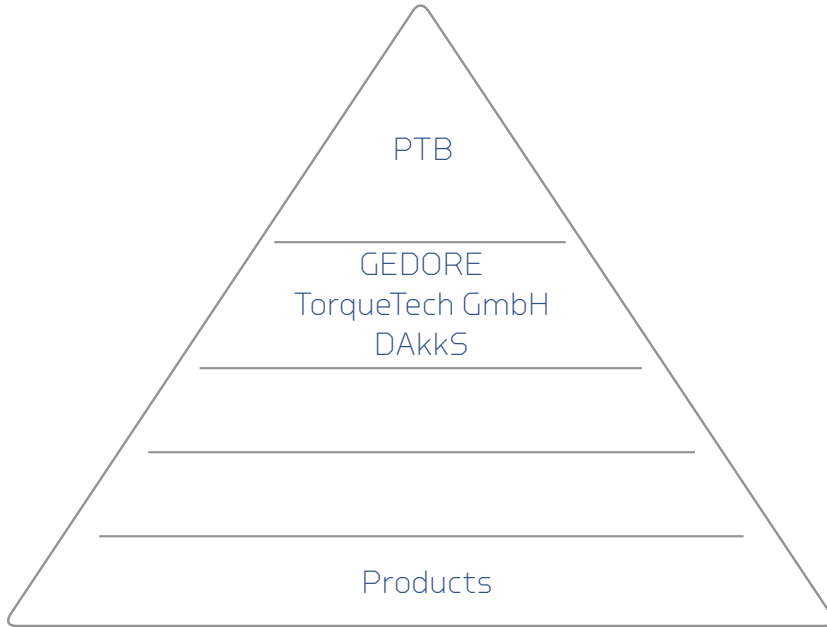

- › Direct traceability to the national standard
- › DAKKS calibrations to DAKKS Guidelines: DAKKS-DKD-R 3-7:2003; DAKKS-DKD-R 3-8:2003 and DIN EN ISO 6789:2003
- › Minimum measurement inaccuracies
- › DAKKS calibration of our own products and those of other manufacturers
- › Air-conditioned laboratory controls under the most stringent conditions
- › DAKKS calibration certificate and DAKKS calibration stamp

## DAkKS Calibration

### Test subject

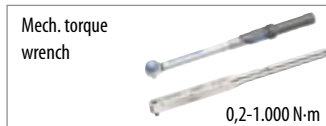

### Test device



### Test result



### Example

A torque wrench is calibrated in accordance with DIN EN ISO 6789:2003. Calibration is performed on test equipment approved by DAKKS.

Depending on the design and type, the torque wrench is calibrated at +/- 4% or +/- 6%. In addition to measurement deviations, measurement inaccuracy is also documented in the DAKKS calibration certificate.

The torque wrench can be used in accordance with the applicable DIN EN ISO standards.

### DAkKS calibration equipment

We calibrate your test equipment or torque wrenches on DAKKS-calibrated reference wrenches or test equipment. DAKKS calibrations of test equipment are performed regularly by PTB and/or Schatz. This fact ensures that the maximum possible accuracies and minimum possible measurement inaccuracies are provided. Before each calibration process, a preliminary test is performed in our DAKKS laboratory on each item of calibration equipment and on each reference wrench.

### International recognition

The DAKKS calibration certificate and therefore the measurement results listed are recognised in many other countries as official evidence of traceability. This is based on multilateral treaties.

## DAkKS calibration certificate

The DAKKS calibration certificate documents the calibration result - the DAKKS calibration mark on the test item identifies the DAKKS laboratory performing calibration. Please note our registration number: DK-15200-01-00. During the test process, the GEDORE TorqueTech GmbH calibration laboratory is obliged to comply with the contractual criteria of the DAKKS (formerly DKD).

Apart from the standard test certificate contents, the DAKKS calibration certificate also takes consideration of the measurement inaccuracies of the test equipment used. The documented calibration result includes the measuring inaccuracies of both the test item and the test equipment.

DAkKS calibration therefore represents maximum safety for controlled tightening.

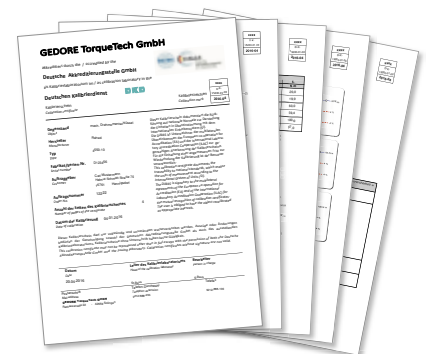



## OUR SERVICE - QUALIFIED AND CUSTOMISED

Our reasonably-priced factory calibration service fulfills the requirements according to DIN EN ISO 6789. Our proprietary accredited DAkkS calibration laboratory creates certificates in accordance with the applicable standards and requirements as per DAkkS 3-7 and DAkkS 3-8 as well as DIN EN ISO 6789:2003.

Our repair service will repair your GEDORE torque wrenches within 5-7 working days.

Please note that the torque wrench is an item of measuring equipment.

### We recommend

- › Calibration once a year (DIN EN ISO 6789:2003)  
or after 5000 load cycles (DIN EN ISO 6789:2003)

### Your advantage

- › Torque wrench offering measurement accuracy
- › Free\* calibration service at GEDORE TorqueTech GmbH

\*Only applies for mechanical items supplied by us (RAHSOL/GEDORE)  
Full service package / services only apply for Germany. Please enquire in our subsidiaries about the possibilities for your respective country.

Regular calibration, adjustment and certification. Why is this so important?

- › Only then can we guarantee the precision and reliability of our torque tools over the long term. We attach a great deal of importance to this as your safety is something which is close to our heart.
- › Because we offer you the safety you require for everyday "controlled tightening".

**GEDORE - competent control of the highest level**



# HEALTH IS THE MOST IMPORTANT FACTOR WHEN IT COMES TO LIVING A HAPPY LIFE.

To ensure that you use our tools safely, please observe the following information.\*

## Why should heavy tools be stored in the bottom?

- › Always store the heaviest tools in the bottom (heavy-duty) drawer.
  - › When the bottom drawer is opened, the centre of gravity is relocated to a safe range.
  - › Storing heavy tools in the upper drawers relocates the centre of gravity upwards.
  - › When the drawer is opened, the centre of gravity is relocated to a critical range.
  - › This makes the tool trolley very susceptible to lateral forces. If the trolley is exposed to lateral forces such as impact, it can overturn.
  - › Always observe the load capacity for each drawer to ensure that you always stay in the safe range.
- › S1 = tool trolley centre of gravity when the drawer is closed  
› S2 = tool trolley centre of gravity when the drawer is opened  
› red = critical range- danger of overturning

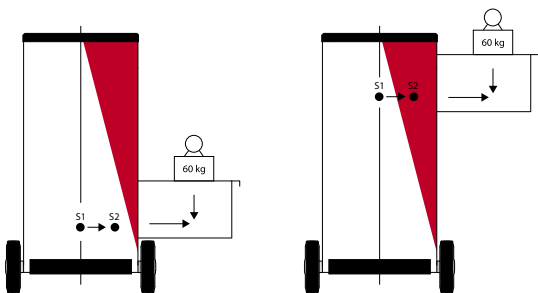

## **i** General

- › Always wear safety goggles for tasks involving chips or the possibility of parts splintering.
- › Only use the hand tools for their intended purpose.
- › Never modify or tamper with tools. Exceptions: Professional regrinding of chisels, scrapers, cutting tools as well as hammer edges.
- › Never work with damaged tools. Damaged tools must be replaced immediately.
- › Handles must be free of oil and grease.
- › Depending on the task, protect your hands by wearing work gloves.
- › Work on live circuits may only be performed by qualified personnel using suitable VDE tools.
- › Choose a safe surface to ensure stability. Wear safety shoes.
- › Wear the specified ear protection when working in noisy environments.

## Tool trolley

- › Read the operating instructions.
- › Only open one drawer at a time. Opening several drawers at a time increases the tilting moment and the tool trolley can overturn.
- › Always store the heaviest tools in the bottom (heavy-duty) drawer. Storing heavy tools in the upper drawers relocates the centre of gravity upwards which in turn increases the tilting moment. The tool trolley can overturn.
- › Observe the permissible load capacity of individual drawers and the overall load capacity of the tool trolley.
- › Only move the tool trolley when the drawers are closed and locked. Watch out for loose items on the shelf or working area.
- › Always activate the total brake when "parking" the tool trolley. Only then is the tool trolley secured against unintentional movements.
- › Always move the tool trolley facing downwards on slopes.
- › Do not use the tool trolley for climbing.
- › Never store pointed or sharp items loosely in the tool trolley. Scribers can be made safe by sticking them in a cork, for example.

## Tool chests

- › Do not use the tool chest for climbing.
- › Never store pointed or sharp items loosely in the tool chest. Scribers can be made safe by sticking them in a cork, for example.
- › Take care of your back by going down on your hunkers and keeping your upper body straight when lifting out the tool box.

## Spanners

- › Only use spanner sizes and profiles which fit the bolt or nut head.
- › Do not use spanners as levers or as striking tools.
- › Select the spanner in accordance with the screwed connection. This particularly applies to screwed connections with high torques.
- › Never extend the tool lever arm except when the tools are designed especially for this purpose, e.g. single-ended ring spanners.
- › Never hit a spanner with a hammer except when the tools have an area designed especially for this purpose, e.g. slogging spanners.
- › Always apply the spanner at a right angle to the bolt axis.
- › Always pull the spanner towards you. Never push the spanner away from you. If for design reasons you can only press the spanner away from you, use your open hand to prevent injuring your knuckles.
- › Ring spanners transmit the forces more consistently. Ring spanners are therefore more suitable for large torques.
- › Apply open-ended spanners in such a way that the angle of the jaw is facing in the direction of rotation.
- › If a torque is specified for the screwed connection, use a torque wrench.
- › Never work with damaged spanners. Do not repair damaged spanners but rather replace them without delay.

\* Furthermore, the relevant safety guidelines of various institutions apply, e.g. the guidelines of the trade associations, employers' instructions and the statutory specifications of the respective country.





## Screwdrivers

- › Choose the screwdriver which is suitable for the respective bolt head profile.
- › Place the workpiece on a ledge or clamp it. This helps to avoid injuries incurred by sliding blades.
- › Avoid cuts by directing the requisite pressure for releasing or tightening the bolt head away from your body.
- › Wear protective gloves when working with screwdrivers.
- › If the screwdriver is too long, do not under any circumstances shorten the blade or handle. Choose a shorter screwdriver.
- › Do not use the screwdriver as a caulking or crushing tool.
- › Light hammer impact may only be applied for loosening screws using suitable screwdrivers with striking cap or continuous blade.
- › If the bolt fails to loosen, use the GEDORE impact driver set no. K 1900-013 to release the bolt without destroying it.
- › Insulated and tested screwdrivers must be used when working on electrical systems.

## VDE tools

- › Work on electrically live equipment may only be carried out by trained electricians.
- › Only tools and safety equipment marked with the double triangle or bell 1000 V symbol (refer to BGV A3) may be used.
- › Before commencing any work, check the insulation for damage.
- › Damaged tools must not be used.
- › The regulations of the employers' liability insurance associations and power supply companies must be complied with.
- › GEDORE VDE tools are approved for work on live circuits at voltages up to 1000 V AC and 1500 V DC.
- › Tools must not be combined unless they are designed to be securely joined together.

## Ratchets, tools and sockets

- › Ratchets are suitable for swift releasing and tightening.
- › Avoid jerky movements with the ratchet, e.g. caused by hammer impact.
- › The square drive and the tool and socket square drive must be of the same size.
- › Select the drive size in accordance with the screwed connection. This particularly applies to screwed connections with high torques.
- › Ensure that the ball engages properly in the ball catch.
- › Always pull the tool towards you. Never push the tool away from you. If for design reasons you can only press the tool away from you, use your open hand to prevent injuring your knuckles.
- › Only use suitable sockets and connections for the impact driver. Use a safety pin and ring to secure the connection between the socket, extension and machine.
- › When using reducers, the smaller drive's torque always applies.
- › Do not use ratchets as levers or as striking tools.

## Pullers

- › Read the operating instructions!
- › Use only original spare parts and accessories for your GEDORE puller. Never use worn, modified or defective spare parts or accessories.
- › Wear goggles and protective clothing when working. For added safety, use the GEDORE safety cover 5.10!
- › Before pulling, ensure that the legs are in contact with the part to be pulled and are firmly tightened so that the spindle operates centrally along the axis of the puller.
- › Attention! When using a puller, forces of up to several tons are generated! Take care to ensure that the puller is correctly positioned and is vertical to the component being pulled.
- › Do not use electric or pneumatic power or percussion drivers.

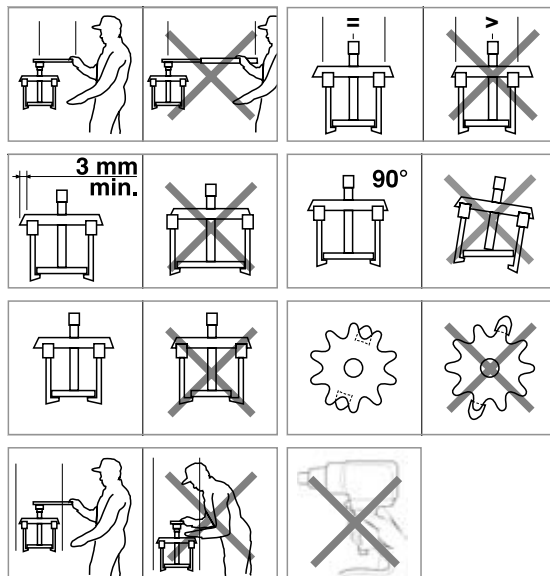





## Pipe bending systems

- › Read the operating instructions.
- › Never use defective or worn pipe bending systems.  
Replace defective or worn parts with original parts.
- › Use suitable systems and tools for bending.
- › Wear safety goggles, safety shoes and protective clothing.
- › Ensure stability of the pipe bending system during the bending process.



## Safety notes for striking tools

### Chisels

- › Wear safety glasses and safety gloves!
- › Before starting work, check that the chisel blade is sharp and the striking end is burr-free! The blades must be properly wet-sharpened!
- › Select the appropriate type and size of chisel for the work to be carried out!
- › Hold the chisel with a firm grip!
- › When working, keep your eyes on the chisel tip!
- › Wherever possible, use a chisel with hand guard.
- › Never use chisels on workpieces harder than 40 HRC!
- › Set safety guards in place to prevent splinters and chips posing a hazard for other people!

### Centre punches, drifts and mortise chisels

- › These tools are subject to the same safety rules as chisels.



## Cutting tools

- › Always set cutting tools down on a clearly visible place. Handles should always point towards you.
- › Sharpen your cutting tools regularly. Blunt cutting tools represent a greater risk of injury than sharp ones. Blunt cutting tools require more force to be applied.
- › Store cutting tools separately. This protects the blades and your fingers.
- › Set shears down with their tips closed. This protects the blades and your fingers.



## Torque tools

- › Read the operating instructions.
- › Only use correctly calibrated torque wrenches.
- › Treat torque wrenches as measuring equipment. Store torque wrenches carefully.
- › Only use torque wrenches within the permissible torque range.
- › Stop tightening the bolt immediately once you feel and hear the "click" signal.
- › Apply the torque wrench at a right angle to the screwed connection.
- › Only use original end fittings or accessories which fit the respective torque wrench.
- › Where possible, do not use any reducers.
- › Never loosen bolts using a torque wrench.
- › Never use the torque wrench as a hammer.
- › Slacken the torque wrench after completing work.
- › Never use defective or worn accessory parts. Replace defective or worn parts with original parts.
- › Only use one hand on the handle of the torque wrench;  
two-handed operation is only possible using DREMOMETER A - F.



## Torque Multipliers

- › Read the operating instructions!
- › Wear safety goggles, safety shoes and protective clothing!
- › Always inspect the torque multiplier for damage before use!
- › Never use electric, pneumatic or battery-operated torque multipliers or impact wrenches!
- › Never exceed the specified maximum input torque!
- › Always use impact sockets in accordance with DIN 3129 or ISO 2725-2 and ISO 1174!
- › Always securely connect the reaction arm to the support bolt!
- › Never extend the impact socket or connector between bolt and torque multiplier!
- › Never use a universal or cardan joint!
- › Never hit the torque multiplier with a hammer!
- › Do not drop the torque multiplier!
- › Never use the torque multiplier if it has been dropped, used to strike other objects, or if anything has fallen on it.
- › Always keep hands and fingers away from the reaction arm!
- › Always select an anchor point (wall, another bolt) sufficient to withstand torque reaction forces! Reaction torque equals output torque.
- › Never allow the gearbox to touch a wall or other object!
- › Never modify the reaction arm without consulting with the manufacturer!



## Safety notes for hammers

- › Wear safety glasses and safety gloves!
- › Use the hammer only for its intended purpose!
- › Never misuse the hammer as a lever!
- › Before starting work, check that the hammer head is securely attached to the shaft!
- › Select the appropriate type and size of hammer for the work to be carried out!
- › Never hit two hammers together!
- › Never use steel hammers on workpieces harder than 46 HRC! Use suitable plastic-faced hammers for this! In case of doubt, the healthier choice is a suitable plastic-faced hammer.
- › Avoid bouncing blows!
- › Use only the work faces of the hammer! Blows with the side face damage the non-hardened hammer eye. This can loosen the grip of the shaft in the hammer head.
- › If a burr forms on the peen or face of the hammer head, this must be immediately removed. Failure to do this can pose the risk of splintering when the hammer is in use.
- › Grip the hammer shaft as far away from the hammer head as possible! This improves the impact effect and avoids vibrations.
- › Do not store hammers with wooden shafts in warm, dry environments! Wood is a natural product. Dry, warm storage conditions cause the shaft to lose moisture and shrink, so that the hammer shaft is no longer a tight fit in the hammer head. Opposite storage conditions also have a negative effect on the wooden shaft. Do not store the wooden shaft in too damp conditions! Too much moisture causes the wooden shaft to swell up and damages the wooden fibres. This can result in the wooden shaft snapping behind the eye area.
- › Use only approved non-sparking hammers for work in explosion-hazard areas!
- › Use only suitable GEDORE replacement shafts and wedges.



## Safety notes

- › For engines with ignition coils integrated in the spark-plug connector (coil-on-plug), use only spark-plug sockets with retainer springs! (Nos. 50 - 59)
- › Do not use magnetic spark-plug spanners on coil-on-plug spark plugs!
- › This can result in control unit faults!



## Work gloves

- › Read the operating instructions.
- › Ensure that your work gloves are suitable for the respective task to be performed. Examine your work gloves for damage before use. Damaged work gloves must be replaced.
- › Only work using work gloves which fit your hands perfectly.
- › Store your work gloves in a clean and dry place.



## Safety goggles

- › Read the operating instructions.
- › Ensure that your safety goggles are suitable for the respective task to be performed.
- › Examine your safety goggles for damage before use. Damaged safety goggles must be replaced.
- › Store safety goggles in dry areas. Use the black plastic bag provided for this purpose. This will help you to avoid scratches on the lenses.
- › Clean the lenses regularly under running water, not when dry.
- › Do not wear safety goggles on top of standard spectacles. Mechanical effects can be transferred which may be dangerous.



## Ear protection

- › Read the operating instructions.
- › Ensure that your ear protection is suitable for the respective task to be performed.
- › Examine your ear protection for damage before use. Ear protection displaying damage must be replaced.
- › Wear ear protection for the entire duration of your stay in noisy areas.
- › Store your ear protection in a clean and dry place.
- › Avoid impact against the earpieces. Otherwise, this can lead to a noise level which is harmful for your ears.



## Pliers

- › Wear protective goggles when working with pliers! Ejected bits of wire and circlips not correctly positioned in the tip of the pliers pose a risk to your eyes!
- › Check on the jaws for wear and tear! Worn jaws result in slipping and thus in accidents.
- › The joint of the pliers is not to have any noticeable play! Exceptions are the sliding joints.
- › When cutting wire, choose pliers that match the wire diameter and wire hardness!
- › Never use pliers as hammers!
- › Only insulated and tested pliers are to be used when working on electrical equipment!
- › Grip wrenches are only for briefly fixing workpieces!

# TIGHTENING / TEST TORQUE



Suggested bolt tightening torque in N-m (Newton metres)							Wrench/spanner test torques in accordance with DIN ISO 1711-1 (minimum guaranteed values) N-m							
M	Tightening values for quality grade as per DIN 267						mm	No. 2, 2A, 2B No. 1B, 308, 7	No. 4	No. 6, No. 1B, 7, 400	No. 25	No. 26 R No. 626	No. 35 A No. 35 B No. 3112	No. 894 No. 895
	4.6	5.6	6.9	8.8	10.9	12.9								
M 2	0,123	0,162	0,314	0,373	0,520	0,628	4			1,90				
M 2,2	0,196	0,265	0,510	0,598	0,843	1,010	4,5*			2,64				
M 2,5	0,284	0,373	0,726	0,863	1,206	1,451	5	11,5		3,55				
M 3	0,441	0,588	1,128	1,344	1,883	2,256	5,5	14,4		4,64		14,4		2,32
M 3,5	0,677	0,902	1,736	2,060	2,893	3,481	6*	17,6	7,4	5,92		17,6		2,96
M 4	1,000	1,344	2,599	3,040	4,315	5,148	7	25,2	11,4	9,12		25,2		4,56
M 5	1,916	2,648	5,099	6,031	8,483	10,200	8 9*	34,5 45,4	16,6 23	13,3 18,4		34,5 45,4	34,5 45,4	6,65 9,20
M 6	3,432	4,511	8,728	10,300	14,710	17,652	10	58,1	31	24,8	58,1	58,1	58,1	12,4
M 7	5,590	7,453	14,220	17,162	24,517	28,439	11 12*	72,7 89,1	40,4 51,5	32,3 41,2	72,7 89,1	72,7 89,1	72,7 89,1	16,1 20,6
M 8	8,238	10,787	21,575	25,497	35,304	42,168	13 14*	107 128	64,5 79,4	51,6 63,5	107 128	107 128	107 128	25,8 31,7
M 10	16,67	21,575	42,168	50,014	70,608	85,317	15 16 17*	150 175 201	96,2 115 134	77,0 92,3 107	150 175 201	150 175 201	150 175 201	38,5 46,1 53,5
M 12	28,44	38,246	73,550	87,279	122,60	147,10	18 19* 20*	230 261 294	160 186 215	128 149 172	230 261 294	230 261 294	230 261 294	64,0 74,5 86,0
M 14	45,11	60,801	116,70	138,30	194,20	235,40	21 22* 23*	330 368 408	247 281 319	198 225 255	330 368 408	330 368 408	330 368 408	99,0 112 127
M 16	69,63	93,163	178,5	210,80	299,10	357,90	24 25* 26*	451 496 544	359 402 449	287 322 359	451 496 544	451 496 544	451 496 544	143 161 179
M 18	95,12	127,50	245,20	289,3	411,90	490,30	27 28*	594 647	499 552	399 442	594 647	594 647	594 647	199 221
M 20	135,3	180,45	384,10	411,90	578,60	696,30	30	760	670	536	760	760	760	268
M 22	182,4	245,16	470,70	559,00	784,50	941,40	32* 34	884 1019	804 951	643 761	884 1019	884 1019	884 1019	321 381
M 24	230,5	308,91	598,20	711,00	1000	1196	36	1165	1117	894	1165	1165	1165	447
M 27	343,2	460,90	887,50	1049	1481	1775	41	1579	1442	1154	1579	1579	1579	577
M 30	465,8	622,72	1206	1422	2010	2403	46	2067	1816	1453	2067	2067	2067	726
M 33	632,5	848,30	1628	1932	2716	3266	50	2512	2145	1716	2512	2512	2512	858
M 36	814,0	1089	2099	2481	3491	4197	55	3140		2077	3140	3140	3140	1038
M 39	1059	1412	2716	3226	4531	5443	60	3849		2471	3849		3849	1235
M 42	1304	1746	3364	3991	5609	6727	65	4021		2900	4021		4021	1422
M 45	1638	2177	4207	4992	7012	8414	70	4658		3364	4658		4658	1618
M 48	1981	2638	5080	6021	8473	10150	75	5394		3862			5394	1765
M 52	2540	3393	6541	7747	10885	13092	80	6178		4394			6178	1912
M 56	3168	4227	8149	9650	13582	16279	85	6963					6963	2059
M 60	3932	5247	10101	11964	16867	20202	90	7845					7845	-
M 64	4737	6306	12160	14416	20300	24320	95	8336					8336	-

\* These sizes are not included in DIN ISO 272

**Note:** In reference to the "spanner test torque as per DIN ISO 1711-1" column, we explicitly point out that these are minimum guarantee values. Bolts from M39 in quality grades 4.6, 5.6, 6.9, 8.8, 10.9 and 12.9 are not standardised.

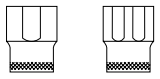

# TIGHTENING / TEST TORQUE

Wrench/spanner test torques in accordance with DIN ISO 1711-1 (minimum guaranteed values) N-m					Test torques for tightening tools for hexagon socket head screws									
M	mm	With internal square as per DIN 3120					DIN EN ISO 4762	No. 42T, DT42 No. 42, 42EL	No. IN 34	With hexagon head as per DIN 7422				
		6,3	10	12,5	20	25				6,3	10	12,5	20	25
		No. 20 No. D 20	No. 30 No. D 30	No. 19 No. D 19	No. 32 No. D 32	No. D 21				No. IN 20	No. IN 30	No. IN 19	No. IN 32	No. IN 21
														
		1/4"	3/8"	1/2"	3/4"	1"			1/4"	3/8"	1/2"	3/4"	1"	
M 2	4	10,4					1,5	0,82						
M 2,2	4,5*	12,6					2	1,9	1,9					
M 2,5	5	15,1												
M 3	5,5	17,8					2,5	3,8	3,8					
M 3,5	6*	20,6	23,2											
M 4	7	26,8	33,2				3	6,6	6,6	6,6				
M 5	8	33,6	45,5	94,1			4	16	16	16	16	16		
	9*	41,1	59,9	119,2										
M 6	10	49,1	76,7	147			5	30	30	30	30	30		
M 7	11	57,8	96	178										
	12*	67,0	118	212										
M 8	13	68,6	141	249			6	52	52	52	52	52		
	14*	68,6	169	288			7	80		78	78			
M 10	15		198	331			8	120	120	120	120	120		
	16		225	377										
	17*		225	425			9	165			165			
M 12	18		225	477			10	220	220		220	220		
	19*		225	531										
	20*		225	569			12	370	370			370		
M 14	21		225	569										
	22*		225	569	569									
	23*			569	569									
M 16	24			569	569		14	590	590		590	590		
	25*			569	583									
	26*			569	624									
M 18	27			569	665									
	28*			569	707									
M 20	30			569	795		17	980	980		1000	1000	1000	
M 22	32*			569	888									
	34			569	984									
M 24	36				1084	1677	19	1360	1360		1400	1400	1400	
M 27	41				1353	1910								
M 30	46				1569	2143	22	2110				2100	2100	
M 33	50				1569	2329	24	2750						2700
M 36	55				1569	2562	27	3910						
M 39	60				1569	2795	30	4000						
M 42	65					2795	32	4000						
M 45	70													
						2795								
M 48	75						36	4000						
M 52	80													
						2795								
M 56	85													
M 60	90													
M 64	95													

The matching test torques are derived from the theoretical load capability of the connecting square drive.



**Note:** Hand tightening sockets are unsuited to use with impact drivers. Inappropriate use poses an accident risk. Power driver sockets can be found on page 230.

# HEAD WIDTHS AND THREAD DIAMETERS

Nominal size DIN ISO 272 normal (large) mm	Thread diameter Ø		Nominal size	Nominal size		Thread diameter Ø		Nominal size	
	Metric as per DIN ISO 272	Metric for high- tensile bolted structural joints as per EN 14399-4	"AF"	Inch	mm	Whitw.	BS 916, 1083	Inch	mm
3,2 (-) 4 (-)	1,6 2								
5 (-) 5,5 (-)	2,5 3		5/32 3/16	0,1562 0,1875	3,97 4,76	8 BA 7 BA 6 BA		0,152 0,172 0,193	3,86 4,37 4,90
7 (-) 8 (-)	4 5		7/32 1/4	0,2187 0,2500	5,56 6,35	5 BA 4 BA 1/16 W		0,220 0,248 0,256	5,59 6,30 6,90
10 (-) 11 (-)	6 7		9/32 5/16	0,2812 0,3125	7,14 7,94	3 BA 3/32 W 2 BA		0,282 0,297 0,324	7,16 7,54 8,23
13 (-) 16 (-)	8 10		11/32 3/8 13/32	0,3438 0,3750 0,4062	8,73 9,52 10,32	1/8 W 1 BA 0 BA	(3/16) (7/32)	0,340 0,365 0,413	8,64 9,27 10,49
18 (21) 21 (24) 22	12 14	12	7/16 1/2	0,4375 0,5000	11,11 12,70	3/16 W 1/4 W	1/4 5/16	0,445 0,525	11,30 13,34
24 (27) 27 (30)	16 18	16	9/16 19/32 5/8	0,5625 0,5938 0,6250	14,29 15,08 15,88	5/16 W	3/8	0,600	15,24
30 (34) 32 34 (36)	20 22	20	11/16 3/4	0,6875 0,7500	17,46 19,05	3/8 W	7/16	0,710	18,03
36 (41) 41 (46)	24 27	22 24	25/32 13/16 7/8	0,7812 0,8125 0,8750	19,84 20,64 22,22	7/16 W	1/2	0,820	20,83
46 (50) 50 (55)	30 33	27 30	15/16 1.	0,9375 1,0000	23,81 25,40	1/2 W	9/16	0,920	23,37
55 (60) 60 (65)	36 39	36	1.1/16	1,0625	26,99	9/16 W 5/8 W	5/8 (11/16)	1,010 1,100	25,65 27,94
65 70	42 45		1.1/8 1.3/16 1.1/4	1,1250 1,1875 1,2500	28,58 30,16 31,75	11/16 W	3/4	1,200	30,48
75 80	48 52		1.5/16 1.3/8 1.7/16	1,3125 1,3750 1,4375	33,34 34,92 36,51	3/4 W 13/16 W	7/8 (15/16)	1,300 1,390	33,02 35,31
85 90	56 60		1.1/2 1.5/8 1.11/16	1,5000 1,6250 1,6875	38,10 41,28 42,86	7/8 W 1. W	1. 1.1/8	1,480 1,670	37,59 42,42
95 100	64 68		1.3/4 1.13/16 1.7/8	1,7500 1,8125 1,8750	44,45 46,04 47,62	1.1/8 W	1.1/4	1,860	47,24
105 110	72 76		2. 2.1/16 2.3/16	2,0000 2,0625 2,1875	50,80 52,39 55,56	1.1/4 W	1.3/8	2,050	52,07
115 120	80 85		2.1/4 2.3/8 2.7/16	2,2500 2,3750 2,4375	57,15 60,32 61,91	1.3/8 W 1.1/2 W	1.1/2 1.5/8	2,220 2,410	56,39 61,21
130	90		2.9/16 2.5/8 2.3/4	2,5625 2,3750 2,7500	65,09 66,68 69,85	1.5/8 W 1.3/4 W	1.3/4 2.	2,580 2,760	65,53 70,10
135	95		2.13/16 2.15/16 3	2,8125 2,9375 3,0000	71,44 74,61 76,20	(1.7/8W)			76,70
145	100		3.1/8 3.3/8 3.1/2	3,1250 3,3750 3,5000	79,38 85,72 88,90		2.1/4 2.1/2	3,150 3,550	80,01 90,17
150	105		3.3/4 3.7/8	3,7500 3,8750	95,25 98,42		2.3/4	3,890	98,81
155	110		4.1/8 4.1/4 4.1/2	4,1250 4,2500 4,5000	104,78 107,95 114,30		3. 3.1/4	4,180 4,530	106,17 115,06
165	115		4.5/8 4.7/8 5.	4,6250 4,8750 5,0000	117,48 123,82 127,00		3.1/2	4,850	123,19
170	120		5.1/4 5.3/8 5.5/8	5,2500 5,3750 5,6250	133,35 136,52 142,88		3.3/4 4.	5,180 5,550	131,57 140,97
180	125		5.3/4 6. 6.1/8	5,7500 6,0000 6,1250	146,05 152,40 155,58		4.1/2	6,380	162,05
185	130								
200	140								
210	150								

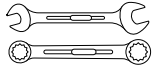

# SPANNER SIZES TOLERANCE FOR BOLTS AND SOCKET WRENCHES

Nominal size /s in mm 	Tolerance class 1 as per ISO 691 dimensions 		Tolerance class 2 <sup>a</sup> as per ISO 691 dimensions 	
	min.	max.	min.	max.
2 ≤ s < 3	+ 0,02	+ 0,08	+ 0,02	+ 0,12
3 ≤ s < 4	+ 0,02	+ 0,10	+ 0,02	+ 0,14
4 ≤ s < 6	+ 0,02	+ 0,12	+ 0,02	+ 0,16
3 ≤ s < 10	+ 0,03	+ 0,15	+ 0,03	+ 0,19
10 ≤ s < 12	+ 0,04	+ 0,19	+ 0,04	+ 0,24
12 ≤ s < 14	+ 0,04	+ 0,24	+ 0,04	+ 0,30
14 ≤ s < 17	+ 0,05	+ 0,27	+ 0,05	+ 0,35
17 ≤ s < 19	+ 0,05	+ 0,30	+ 0,05	+ 0,40
19 ≤ s < 26	+ 0,06	+ 0,36	+ 0,06	+ 0,46
26 ≤ s < 33	+ 0,08	+ 0,48	+ 0,08	+ 0,58
33 ≤ s < 55	+ 0,10	+ 0,60	+ 0,10	+ 0,70
55 ≤ s < 75	+ 0,12	+ 0,72	+ 0,12	+ 0,92
75 ≤ s < 105	+ 0,15	+ 0,85	+ 0,15	+ 1,15
105 ≤ s < 150	+ 0,20	+ 1,00	+ 0,20	+ 1,40
150 ≤ s < 210	+ 0,25	+ 1,22	-	-

This tolerance class applies only to ring spanners or socket wrenches that have not been manufactured by material removal.

**Spanner sizes in accordance with this international standard must be marked with:**

- a) Spanner head size
- b) Reference to the international standard, i.e. ISO 691
- c) Nominal size s in millimetres
- d) Tolerance class 1 or 2

## Conversion tables Inch to decimal-inches and mm

in.	dec.in.	mm.	in.	dec.in.	mm.
<b>0</b>	<b>0</b>	<b>0</b>	<b>1/2</b>	<b>0.5</b>	<b>12,7000</b>
1/64	0.015625	0,3969	33/64	0.515625	13,0969
1/32	0.03125	0,7938	17/32	0.53125	13,4938
3/64	0.046875	1,1906	35/64	0.546875	13,8906
<b>1/16</b>	<b>0.0625</b>	<b>1,5875</b>	<b>9/16</b>	<b>0.5625</b>	<b>14,2875</b>
5/64	0.078125	1,9844	37/64	0.578125	14,6844
3/32	0.09375	2,3812	19/32	0.59375	15,0812
7/64	0.109375	2,7781	39/64	0.609375	15,4781
<b>1/8</b>	<b>0.125</b>	<b>3,1750</b>	<b>5/8</b>	<b>0.625</b>	<b>15,8750</b>
9/64	0.140625	3,5719	41/64	0.640625	16,2719
5/32	0.15625	3,9688	21/32	0.65625	16,6688
11/64	0.171875	4,3656	43/64	0.671875	17,0656
<b>3/16</b>	<b>0.1875</b>	<b>4,7625</b>	<b>11/16</b>	<b>0.6875</b>	<b>17,4625</b>
13/64	0.203125	5,1594	45/64	0.703125	17,8594
7/32	0.21875	5,5562	23/32	0.71875	18,2562
15/64	0.234375	5,9531	47/64	0.734375	18,6531
<b>1/4</b>	<b>0.25</b>	<b>6,3500</b>	<b>3/4</b>	<b>0.75</b>	<b>19,0500</b>
17/64	0.265625	6,7469	49/64	0.765625	19,4469
9/32	0.28125	7,1438	25/32	0.78125	19,8438
19/62	0.296875	7,5406	51/62	0.796875	20,2406
<b>5/16</b>	<b>0.3125</b>	<b>7,9375</b>	<b>13/16</b>	<b>0.8125</b>	<b>20,6375</b>
21/64	0.328125	8,3344	53/64	0.828125	21,0344
11/32	0.34375	8,7312	27/32	0.84375	21,4312
23/64	0.359375	9,1281	55/64	0.859375	21,8281
<b>3/8</b>	<b>0.375</b>	<b>9,5250</b>	<b>7/8</b>	<b>0.875</b>	<b>22,2250</b>
25/64	0.390625	9,9219	57/64	0.890625	22,6219
13/32	0.40625	10,3188	29/32	0.90625	23,0188
27/64	0.421875	10,7156	59/64	0.921875	23,4156
<b>7/16</b>	<b>0.4375</b>	<b>11,1125</b>	<b>15/16</b>	<b>0.9375</b>	<b>23,8125</b>
29/64	0.453125	11,5094	61/64	0.953125	24,2094
15/32	0.46875	11,9062	31/32	0.96875	24,6062
31/64	0.484375	12,3031	63/64	0.984375	25,0031
			1	1	25,4000

# TORQUE CONVERSION TABLES

Units to be	Torque conversion factors								Corresponding unit
	= mN·m	= cN·m	= N·m	= ozf·in	= lbf·in	= lbf·ft	= gf·cm	= f·cm (kp·cm)	
1 mN·m	1	0,1	0,001	0,142	0,009	0,0007	10,2	0,01	0,0001
1 cN·m	10	1	0,01	1,416	0,088	0,007	102	0,102	0,001
1 N·m	1000	100	1	141,6	8,851	0,738	10197	10,2	0,102
1 ozf·in	7,062	0,706	0,007	1	0,0625	0,005	72	0,072	0,0007
1 lbf·in	113	11,3	0,113	16	1	0,083	1152,1	1,152	0,0115
1 lbf·ft	1356	135,6	1,356	192	12	1	13826	13,83	0,138
1 gf·cm	0,098	0,01	0,0001	0,014	0,0009	0,00007	1	0,001	0,00001
1 kgf·cm (kp·cm)	98,07	9,807	0,098	13,89	0,868	0,072	1000	1	0,01
1 kgf·m (kp·m)	9807	980,7	9,807	1389	86,8	7,233	100000	100	1

## Application

### Conversion formula:

Units to be converted x factor  
= corresponding unit

### Example:

Convert of 5 lbf·ft in cN·m

### Solution:

5 x 135,6 = 678 cN·m

### Conversion from N·m in kgf·m (kp·m)

1 N·m = 0,102 kgf·m

N·m	0	1	2	3	4	5	6	7	8	9
0	0,00	0,10	0,20	0,31	0,41	0,51	0,61	0,71	0,82	0,92
10	1,02	1,12	1,22	1,33	1,43	1,53	1,63	1,73	1,84	1,94
20	2,04	2,14	2,24	2,35	2,45	2,55	2,65	2,75	2,86	2,96
30	3,06	3,16	3,26	3,37	3,47	3,57	3,67	3,77	3,87	3,98
40	4,08	4,18	4,28	4,38	4,49	4,59	4,69	4,79	4,89	5,00
50	5,10	5,20	5,30	5,40	5,51	5,61	5,71	5,81	5,91	6,02
60	6,12	6,22	6,32	6,42	6,53	6,63	6,73	6,83	6,93	7,04
70	7,14	7,24	7,34	7,44	7,55	7,65	7,75	7,85	7,95	8,06
80	8,16	8,26	8,36	8,46	8,57	8,67	8,77	8,87	8,97	9,08
90	9,18	9,28	9,38	9,48	9,59	9,69	9,79	9,89	9,99	10,10
100	10,20	10,30	10,40	10,50	10,60	10,71	10,81	10,91	11,01	11,11

### Conversion from kgf·m (kp·m) in N·m

1 kgf·m (kp·m) = 9,807 N·m

kgf·m(kp·m)	0	1	2	3	4	5	6	7	8	9
0	0,00	9,81	19,61	29,42	39,23	49,03	58,84	68,65	78,45	88,26
10	98,07	107,87	117,68	127,49	137,29	147,10	156,91	166,71	176,52	186,33
20	196,13	205,94	215,75	225,55	235,36	245,17	254,97	264,78	274,59	284,39
30	294,20	304,01	313,81	323,62	333,43	343,23	353,04	362,85	372,65	382,46
40	392,27	402,07	411,88	421,69	431,49	441,30	451,11	460,91	470,72	480,53
50	490,33	500,14	509,95	519,75	529,56	539,37	549,17	558,98	568,79	578,59
60	588,40	598,21	608,01	617,82	627,63	637,43	647,24	657,05	666,85	676,66
70	686,47	696,27	706,08	715,89	725,69	735,50	745,31	755,11	764,92	774,73
80	784,53	794,34	804,15	813,95	823,76	833,57	843,37	853,18	862,99	872,79
90	882,60	892,41	902,21	912,02	921,83	931,63	941,44	951,25	961,05	970,86
100	980,67	990,47	1000,28	1010,08	1019,89	1029,70	1039,50	1049,31	1059,12	1068,92

### Conversion from N·m in lbf·ft

1 N·m = 0,7376 lbf·ft

N·m	0	1	2	3	4	5	6	7	8	9
0	0,00	0,74	1,48	2,21	2,95	3,69	4,43	5,16	5,90	6,64
10	7,38	8,11	8,85	9,59	10,33	11,06	11,80	12,54	13,28	14,01
20	14,75	15,49	16,23	16,96	17,70	18,44	19,18	19,91	20,65	21,39
30	22,13	22,86	23,60	24,34	25,08	25,81	26,55	27,29	28,03	28,76
40	29,50	30,24	30,98	31,72	32,45	33,19	33,93	34,67	35,40	36,14
50	36,88	37,62	38,35	39,09	39,83	40,57	41,30	42,04	42,77	43,52
60	44,25	44,99	45,73	46,47	47,20	47,94	48,68	49,42	50,15	50,89
70	51,63	52,37	53,10	53,84	54,58	55,32	56,05	56,79	57,53	58,27
80	59,00	59,74	60,48	61,22	61,96	62,69	63,43	64,17	64,91	65,64
90	66,38	67,12	67,86	68,59	69,33	70,07	70,81	71,54	72,28	73,02
100	73,76	74,49	75,23	75,97	76,71	77,44	78,18	78,92	79,66	80,39

### Conversion from lbf·ft in N·m

1 lbf·ft = 1,356 N·m

lbf·ft	0	1	2	3	4	5	6	7	8	9
0	0,00	1,36	2,71	4,07	5,42	6,78	8,13	9,49	10,85	12,20
10	13,56	14,91	16,27	17,63	18,98	20,34	21,69	23,05	24,40	25,76
20	27,12	28,47	29,83	31,18	32,54	33,90	35,25	36,61	37,96	39,32
30	40,67	42,03	43,39	44,74	46,10	47,45	48,81	50,16	51,52	52,88
40	54,23	55,59	56,94	58,30	59,66	61,01	62,37	63,72	65,08	66,43
50	67,79	69,15	70,50	71,86	73,21	74,57	75,93	77,28	78,64	79,99
60	81,35	82,70	84,06	85,42	86,77	88,13	89,48	90,84	92,20	93,55
70	94,91	96,26	97,62	98,97	100,33	101,69	103,04	104,40	105,75	107,11
80	108,46	109,82	111,18	112,53	113,89	115,24	116,60	117,96	119,31	120,67
90	122,02	123,38	124,73	126,09	127,45	128,80	130,16	131,51	132,87	134,23
100	135,58	136,94	138,29	139,65	141,00	142,36	143,72	145,07	146,43	147,78

### Conversion from N·m in lbf·in

1 N·m = 8,851 lbf·in

N·m	0	1	2	3	4	5	6	7	8	9
0	0,00	8,85	17,70	26,55	35,40	44,25	53,10	61,96	70,81	79,66
10	88,51	97,36	106,21	115,06	123,91	132,76	141,61	150,46	159,31	168,16
20	177,02	185,87	194,72	203,57	212,42	221,27	230,12	238,97	247,82	256,67
30	265,52	274,37	283,22	292,08	300,93	309,78	318,63	327,48	336,33	345,18
40	354,03	362,88	371,73	380,58	389,43	398,28	407,14	415,99	424,84	433,69
50	442,54	451,39	460,24	469,09	477,94	486,79	495,64	504,49	513,34	522,20
60	531,05	539,90	548,75	557,60	566,45	575,30	584,15	593,00	601,85	610,70
70	619,55	628,40	637,26	646,11	654,96	663,81	672,66	681,51	690,36	699,21
80	708,06	716,91	725,76	734,61	743,46	752,32	761,17	770,02	778,87	787,72
90	796,57	805,42	814,27	823,12	831,97	840,82	849,67	858,52	867,38	876,23
100	885,08	893,93	902,78	911,63	920,48	929,33	938,18	947,03	955,88	964,73

### Conversion from lbf·in in N·m

1 lbf·in = 0,113 N·m

lbf·in	0	1	2	3	4	5	6	7	8	9
0	0,00	0,11	0,23	0,34	0,45	0,56	0,68	0,79	0,90	1,02
10	1,13	1,24	1,36	1,47	1,58	1,69	1,81	1,92	2,03	2,15
20	2,26	2,37	2,49	2,60	2,71	2,82	2,94	3,05	3,16	3,28
30	3,39	3,50	3,62	3,73	3,84	3,95	4,07	4,18	4,29	4,41
40	4,52	4,63	4,75	4,86	4,97	5,08	5,20	5,31	5,42	5,54
50	5,65	5,76	5,87	5,99	6,10	6,21	6,33	6,44	6,55	6,67
60	6,78	6,89	7,00	7,12	7,23	7,34	7,46	7,57	7,68	7,80
70	7,91	8,02	8,13	8,25	8,36	8,47	8,59	8,70	8,81	8,93
80	9,04	9,15	9,26	9,38	9,49	9,60	9,72	9,83	9,94	10,06
90	10,17	10,28	10,39	10,51	10,62	10,73	10,85	10,96	11,07	11,19
100	11,30	11,41	11,52	11,64	11,75	11,86	11,98	12,09	12,20	12,31





**Important prefix characters**

Giga	G	1.000.000.000	= 10 <sup>9</sup>
Mega	M	1.000.000	= 10 <sup>6</sup>
Kilo	k	1.000	= 10 <sup>3</sup>
Hecto	H	100	= 10 <sup>2</sup>
Deca	Da	10	= 10 <sup>1</sup>
Deci	d	0,1	= 10 <sup>-1</sup>
Centi	c	0,01	= 10 <sup>-2</sup>
Milli	m	0,001	= 10 <sup>-3</sup>
Micro	μ	0,000001	= 10 <sup>-6</sup>
Nano	n	0,000000001	= 10 <sup>-9</sup>

**Important SI units with conversions to old but still commonly used units**

Length	metre	m		
Masa	kilogramme	kg		
Time	second	s		
Force	newton	N	= m/s <sup>2</sup>	1 N = 0,102 kp
Torque	newton metre	N·m		9,81 N·m = 1 kp·m
Energy (work)	joule	J	= N·m	
Heat quantity	joule	J		1 J = 0,239 cal
Power	watt	W	= N·m/s	1 kW = 1,36 PS = 860 kcal/h
Pressure	pascal	Pa	= N/m <sup>2</sup>	100 000 Pa = 1 bar = 10 mWS
Electrical current	ampere	A		
Temperature	kelvin	K		1 K = 1 °C

**Conversion table, mass and weight**

1 megagramme (Mg)	= 1.000 kg	= 10.000 hg	= 100.000 dag	= 1.000.000 g
1 ton (to.)	= 1.000 kg			
1 kilogramme (kg)		= 10 hg	= 100 dag	= 1000 g
1 hectogramme (hg)			= 10 dag	= 100 g
1 decagramme (dag)				= 10 g
1 gramme (g)	= 10 dg	= 100 cg	= 1000 mg	
1 decigramme (dg)		= 10 cg	= 100 mg	
1 centigramme (cg)			= 10 mg	
1 miligramme (mg)			= 1 mg	

**Conversion table, force and torque**

1 newton	= 0,102 kp
1 kilopond	= 9,81 N
1 kilopond metre	= 9,81 N·m

**Material properties**

	Density g/cm <sup>3</sup>	Expansion 1/°C	Melting point °C	Modulus of elasticity N/mm
Aluminium	2,7	0,000024	660,1	72 000
Lead	11,3	0,000029	327,3	16 000
Iron (Steel)	7,86	0,000012	1540	210 000
Gold	19,3	0,000014	1063	79 000
Copper	8,9	0,000017	1083	126 000
Zinc	7,1	0,000026	419	94 000
Glass	2,2–2,9	0,000008	800–1500	68 000
Air	0,0013	0,0036		
Wood	0,5–0,7			10 000
Plastics/synthetic materials:				
PS,	1,05	0,00008		3 400
PP,	0,9	0,00018		1 200
ABS	1,05	0,00010		2 500

Comparison table of Vickers-Brinell-Rockwell hardness and tensile strength

Vickers hardness HV 30	Brinell hardness HB 30	Rockwell hardness HRB	Rockwell hardness HRC	Tensile strength sB N/mm <sup>2</sup>
80	80,7	36,4	–	270
85	85	42,4	–	290
90	90	47,4	–	310
95	95	52,0	–	320
100	100	56,4	–	340
105	105	60,0	–	360
110	110	63,4	–	380
115	115	66,4	–	390
120	120	69,4	–	410
125	125	72,0	–	420
130	130	74,4	–	440
135	135	76,4	–	460
140	140	78,4	–	470
145	145	80,4	–	490
150	150	82,2	–	500
155	155	83,8	–	520
160	160	85,4	–	540
165	165	86,8	–	550
170	170	88,2	–	570
175	175	89,6	–	590
180	180	90,8	–	600
185	185	91,8	–	620
190	190	91,5	–	640
195	195	94,0	–	660
200	200	95,0	–	670
205	205	95,8	–	680
210	210	96,6	–	710
215	215	97,4	–	720
220	220	98,2	–	730
225	225	99,0	–	750
230	230	–	19,2	760
235	235	–	20,2	780
240	240	–	21,2	800
245	245	–	22,1	820
250	250	–	23,0	830
255	255	–	23,8	850
260	260	–	24,6	870
265	265	–	25,4	880
270	270	–	26,9	900
275	275	–	27,1	920
280	280	–	27,6	940
285	285	–	28,3	950
290	290	–	29,0	970
295	295	–	29,6	990
300	300	–	30,3	1010
310	310	–	31,5	1040
320	320	–	32,7	1080
330	330	–	33,8	1110
340	340	–	34,9	1140
350	350	–	36,0	1170
360	359	–	37,0	1200
370	368	–	38,0	1230
380	376	–	38,9	1260
390	385	–	39,8	1290
400	392	–	40,7	1320
410	400	–	41,5	1350
420	408	–	42,4	1380
430	415	–	43,2	1410
440	423	–	44,0	1430
450	430	–	44,8	1460
460	–	–	45,6	1490
470	–	–	46,3	1520
480	–	–	47,0	1550
490	–	–	47,7	1580
500	–	–	48,3	1600
510	–	–	49,1	1630
520	–	–	49,7	1660
530	–	–	50,4	1690
540	–	–	51,0	1710
550	–	–	51,6	1740
560	–	–	52,2	1770
570	–	–	52,8	1790
580	–	–	53,3	1820
590	–	–	53,9	1850
600	–	–	54,4	1870
610	–	–	55,0	1900
620	–	–	55,5	1930
630	–	–	56,0	1950
640	–	–	56,5	1980
650	–	–	57,0	2000
660	–	–	57,5	2030
670	–	–	58,0	2050
680	–	–	58,5	2080
690	–	–	59,0	2110
700	–	–	59,5	2130
720	–	–	60,4	2170
740	–	–	61,2	2220
760	–	–	62,0	2260
780	–	–	62,8	2300
800	–	–	63,6	–
820	–	–	64,3	–
840	–	–	65,0	–
860	–	–	65,7	–
880	–	–	66,3	–
900	–	–	66,9	–
920	–	–	67,5	–
940	–	–	68,0	–

**Examples**

**Example 1:**

Expansion of a steel body of 100 mm in length at a temperature of 10 °C. Length y expansion coefficient x °C exp. = 100 mm x 0,000012 x 10 = 0,012 mm = 12 μm

**Example 2:**

Elastic expansion e = s/E. A body of 100 mm in length made of ABS is stretched with s = 50 N/mm<sup>2</sup>. e = 50 N/mm<sup>2</sup>: 2500 N/mm<sup>2</sup> = 0.02. The expansion is: 100 mm x 0.02 = 2 mm.

**Example 3:**

Two steel plates with a total thickness of 20 mm are pre-stressed by means of a screw connection of s = 50 N/mm<sup>2</sup>: e = 50: 210000 = 0.00024. The compression in the surrounding area of the screw is 20 mm x 0.00024 = 0,0048 mm = 5 μm.

The elastic compression induces a continuous pre-tension of the screw connection. A properly tensed screw connection is selfinhibiting.

# GUIDELINE VALUES FOR THE COEFFICIENT OF FRICTION $\mu$

Screw thread		Steel							
		blackened or Zinc-phosphate			cadmium-plated 6 $\mu$	zinc-plated 6 $\mu$			
Nut thread			pressed rolled	rolled cut			sharpened		
	Steel	ground	Slightly oiled	0,14	0,10	0,16	0,10	0,10	
sharpened		0,16		0,10	0,16	0,10	0,10		
ground sharpened		Zinc-phosphate		0,14		0,10			
turned sharpened				0,10					
turned sharpened		0,10			0,10	0,10	0,10		
cadmium-plated		6 $\mu$					0,14		
zinc-plated								0,10	
cadmium-plated				Dry	0,10		0,10	0,14	
zinc-plated					0,10		0,10		0,14

## Choosing the right friction value

In order to exactly define the pre-tension force and the tightening torque, it is essential to know the coefficient friction.

However, it would seem almost impossible to specify definite values for the coefficients of friction for the large variety of possible surface and lubrication conditions and above all for their variance. Added to this are the variances of the various different tightening methods which also constitute a greater or lesser factor of uncertainty. For this reason, it is only possible to make recommendations on the choice of the coefficient of friction. 80 % of the tightening-torque values apply for countersunk head screws on account of the remaining base thickness.

## Guideline values for the coefficient of friction $\mu$

In order to exactly define the pre-tension force and the tightening torque, it is essential to know the coefficient of friction. However, it would seem almost impossible to specify definite values for the coefficients of friction for the large variety of possible surface and lubrication conditions and above all for their variance.

### The following circumstances influence the friction value:

The surfaces and the nature of the materials being screwed, the method of lubrication, the sliding path due to the flexibility and the tightening method, i.e. the number and the speed of the tightening cycles and finally the tightening path - the so-called hard or soft screw case. The sum total of these items represents a greater or lesser factor of uncertainty. Even DIN-equivalent screws can differ considerably in their friction value because of being delivered by different suppliers, depending on the screw lot and depending on their storage and, in particular, on the oiling or greasing performed in the course of installation. Please note that around 80 to 90% of the tightening torque in most tightening procedures is required for overcoming the friction in the screw.

### Important remark:

For this reason, it is only possible to give recommendations on the choice of the friction value. We point out explicitly that the following tables only contain guideline values. In all cases, a detailed screw calculation is more reliable than these tables! That applies particularly for parts which are relevant to safety, are subject to official regulations or perform sealing functions. The tables should only be utilised where the manufacturer of the screws or elements being connected has made no specifications on the required tightening torques.



# FRICITION VALUE $\mu_{ges}$ 0,10 AND 0,14

Friction value  $\mu_{ges}$  0,10

Shank screws with metric ISO medium threads in accordance with DIN ISO 261

$\mu_{celk}$ 0,10	P mm	4.6		5.6		6.8		8.8		10.9		12.9	
		$F_{sp}$ N	$M_A$ N-m	$F_{sp}$ N	$M_A$ N-m	$F_{sp}$ N	$M_A$ N-m	$F_{sp}$ N	$M_A$ N-m	$F_{sp}$ N	$M_A$ N-m	$F_{sp}$ N	$M_A$ N-m
M 2	0,4	367	0,108	459	0,135	734	0,216	979	0,288	1.376	0,405	1.651	0,486
M 2,5	0,45	610	0,221	763	0,276	1.221	0,441	1.628	0,588	2.289	0,827	2.747	0,993
M 3	0,5	915	0,392	1.144	0,491	1.830	0,785	2.441	1,047	3.432	1,472	4.118	1,766
M 3,5	0,6	1.228	0,617	1.535	0,771	2.456	1,234	3.274	1,645	4.605	2,313	5.526	2,776
M 4	0,7	1.587	0,914	1.983	1,142	3.173	1,827	4.231	2,436	5.950	3,426	7.139	4,111
M 4,5	0,75	2.059	1,325	2.574	1,656	4.118	2,649	5.491	3,532	7.722	4,967	9.266	5,961
M 5	0,8	2.593	1,843	3.242	2,304	5.187	3,686	6.915	4,915	9.725	6,912	11.670	8,294
M 6	1	3.661	3,140	4.576	3,925	7.322	6,280	9.762	8,373	13.728	11,775	16.473	14,130
M 8	1,25	6.713	7,609	8.391	9,511	13.426	15,218	17.901	20,291	25.173	28,534	30.208	34,240
M 10	1,5	10.683	15,06	13.354	18,82	21.366	30,11	28.488	40,15	40.061	56,46	48.073	67,75
M 12	1,75	15.571	26,24	19.463	32,80	31.142	52,48	41.522	69,97	58.390	98,39	70.068	118,07
M 14	2	21.377	41,92	26.721	52,40	42.753	83,83	57.004	111,78	80.162	157,19	96.195	188,62
M 16	2	29.373	64,80	36.717	81,01	58.747	129,61	78.329	172,81	110.150	243,02	132.180	291,62
M 18	2,5	35.742	89,80	44.678	112,25	71.484	179,60	95.312	239,46	134.033	336,75	160.840	404,09
M 20	2,5	45.896	126,57	57.370	158,21	91.792	253,14	122.389	337,52	172.109	474,64	206.531	569,57
M 22	2,5	57.312	172,1	71.640	215,1	114.623	344,2	152.831	459,0	214.919	645,4	257.902	774,5
M 24	3	66.090	218,7	82.612	273,4	132.180	437,4	176.240	583,2	247.837	820,2	297.405	984,2
M 27	3	86.922	319,7	108.653	399,6	173.845	639,3	231.793	852,4	325.959	1.198,7	391.150	1.438,4
M 30	3,5	105.686	434,0	132.107	542,5	211.371	868,0	281.828	1.157,3	396.321	1.627,4	475.585	1.952,9
M 33	3,5	131.646	589,0	164.557	736,3	263.292	1.178,1	351.056	1.570,8	493.672	2.208,9	592.407	2.650,7
M 36	4	154.529	757,7	193.161	947,1	309.057	1.515,4	412.076	2.020,5	579.482	2.841,4	695.379	3.409,6
M 39	4	185.617	978	232.021	1.223	371.233	1.957	494.978	2.609	696.062	3.669	835.275	4.403
M 42	4,5	212.619	1.212	265.774	1.515	425.238	2.424	566.983	3.232	797.321	4.545	956.785	5.454
M 45	4,5	248.834	1.510	311.043	1.888	497.669	3.020	663.559	4.027	933.129	5.663	1.119.755	6.795
M 48	5	279.956	1.819	349.945	2.274	559.912	3.638	746.550	4.850	1.049.836	6.821	1.259.803	8.185
M 52	5	335.711	2.346	419.639	2.932	671.422	4.692	895.229	6.256	1.258.916	8.797	1.510.700	10.557
M 56	5,5	387.206	2.919	484.007	3.649	774.412	5.839	1.032.549	7.785	1.452.022	10.948	1.742.427	13.137
M 60	5,5	452.319	3.632	565.399	4.540	904.639	7.265	1.206.185	9.686	1.696.198	13.621	2.035.438	16.345
M 64	6	511.800	4.392	639.751	5.490	1.023.601	8.784	1.364.801	11.713	1.919.252	16.471	2.303.102	19.765
M 68	6	586.272	5.319	732.840	6.649	1.172.545	10.638	1.563.393	14.184	2.198.521	19.947	2.638.225	23.936

Shank screws with metric ISO fine-pitch thread in accordance with DIN ISO 261

M 8	1	7.343	8,10	9.179	10,13	14.687	16,20	19.582	21,60	27.537	30,38	33.045	36,45
M 10	1	12.288	16,57	15.360	20,71	24.576	33,14	32.768	44,19	46.080	62,14	55.297	74,57
M 12	1,5	16.522	27,34	20.653	34,17	33.045	54,68	44.060	72,91	61.959	102,52	74.351	123,03
M 14	1,5	23.624	44,89	29.530	56,11	47.249	89,78	62.998	119,70	88.591	168,33	106.309	202,00
M 16	1,5	31.988	68,63	39.984	85,79	63.975	137,26	85.300	183,01	119.953	257,36	143.944	308,83
M 18	1,5	41.612	99,49	52.015	124,36	83.223	198,98	110.965	265,30	156.044	373,08	187.253	447,70
M 20	1,5	52.497	138,4	65.621	173,0	104.993	276,8	139.991	369,1	196.862	519,0	236.235	622,8
M 22	1,5	64.642	186,3	80.803	232,8	129.284	372,6	172.379	496,7	242.408	698,5	290.890	838,3
M 24	1,5	78.048	244,1	97.560	305,1	156.096	488,1	208.129	650,8	292.681	915,2	351.217	1.098,3

Friction value  $\mu_{ges}$  0,14

Shank screws with metric ISO medium threads in accordance with DIN ISO 261

$\mu_{celk}$ 0,10	P mm	4.6		5.6		6.8		8.8		10.9		12.9	
		$F_{sp}$ N	$M_A$ N-m	$F_{sp}$ N	$M_A$ N-m	$F_{sp}$ N	$M_A$ N-m	$F_{sp}$ N	$M_A$ N-m	$F_{sp}$ N	$M_A$ N-m	$F_{sp}$ N	$M_A$ N-m
M 2	0,4	338	0,130	422	0,163	675	0,261	901	0,348	1.267	0,489	1.520	0,587
M 2,5	0,45	563	0,269	703	0,336	1.125	0,537	1.500	0,716	2.110	1,007	2.532	1,209
M 3	0,5	845	0,480	1.056	0,600	1.689	0,961	2.253	1,281	3.168	1,801	3.801	2,161
M 3,5	0,6	1.133	0,754	1.416	0,942	2.266	1,507	3.021	2,009	4.248	2,826	5.098	3,391
M 4	0,7	1.463	1,115	1.829	1,393	2.927	2,229	3.902	2,972	5.487	4,180	6.585	5,016
M 4,5	0,75	1.901	1,621	2.376	2,026	3.801	3,242	5.068	4,323	7.127	6,079	8.553	7,295
M 5	0,8	2.395	2,261	2.994	2,827	4.790	4,523	6.387	6,030	8.982	8,480	10.778	10,176
M 6	1	3.379	3,843	4.224	4,803	6.758	7,685	9.011	10,247	12.671	14,410	15.205	17,292
M 8	1,25	6.202	9,349	7.753	11,686	12.404	18,698	16.539	24,931	23.258	35,059	27.909	42,070
M 10	1,5	9.876	18,54	12.345	23,18	19.752	37,09	26.336	49,45	37.034	69,54	44.441	83,44
M 12	1,75	14.400	32,37	18.000	40,46	28.801	64,74	38.401	86,32	54.001	121,38	64.801	145,66
M 14	2	19.775	51,77	24.719	64,71	39.551	103,54	52.734	138,06	74.158	194,14	88.989	232,97
M 16	2	27.221	80,62	34.027	100,77	54.443	161,24	72.591	214,98	102.080	302,32	122.497	362,78
M 18	2,5	33.078	111,09	41.347	138,86	66.155	222,17	88.207	296,23	124.041	416,58	148.850	499,89
M 20	2,5	42.534	157,46	53.167	196,82	85.067	314,91	113.423	419,88	159.501	590,46	191.401	708,55
M 22	2,5	53.175	215,1	66.469	268,9	106.350	430,2	141.800	573,7	199.406	806,7	239.288	968,0
M 24	3	61.248	272,1	76.560	340,1	122.497	544,2	163.329	725,6	229.681	1.020,3	275.617	1.224,4
M 27	3	80.670	399,9	100.837	499,9	161.339	799,9	215.119	1.066,5	302.512	1.499,7	363.014	1.799,7
M 30	3,5	98.027	541,7	122.533	677,2	196.054	1.083,4	261.405	1.444,6	367.600	2.031,5	441.120	2.437,7
M 33	3,5	122.241	738,5	152.801	923,2	244.482	1.477,1	325.976	1.969,4	458.404	2.769,5	550.084	3.323,4
M 36	4	143.413	948,0	179.266	1.185,0	286.826	1.896,0	382.434	2.528,0	537.798	3.555,0	645.358	4.265,9
M 39	4	172.420	1.229	215.525	1.536	344.839	2.457	459.786	3.276	646.574	4.607	775.888	5.529
M 42	4,5	197.407	1.519	246.758	1.899	394.813	3.038	526.417	4.050	740.275	5.696	888.329	6.835
M 45	4,5	231.206	1.898	289.007	2.373	462.412	3.796	616.549	5.062	867.022	7.118	1.040.426	8.541
M 48	5	260.008	2.282	325.010	2.853	520.015	4.565	693.354	6.086	975.029	8.559	1.170.035	10.211
M 52	5	312.056	2.954	390.070	3.692	624.112	5.907	832.149	7.876	1.170.209	11.076	1.404.251	13.292
M 56	5,5	359.843	3.672	449.804	4.591	719.686	7.345	959.581	9.793	1.349.411	13.772	1.619.293	16.526
M 60	5,5	420.651	4.582	525.813	5.728	841.301	9.164	1.121.735	12.219	1.577.440	17.183	1.892.928	20.619
M 64	6	475.860	5.536	594.825	6.920	951.720	11.071	1.268.960	14.762	1.784.476	20.759	2.141.371	24.911
M 68	6	545.427	6.720	681.784	8.400	1.090.855	13.440	1.454.473	17.919	2.045.353	25.199	2.454.423	30.239

Shank screws with metric ISO fine-pitch thread in accordance with DIN ISO 261

M 8	1	6.805	10,08	8.507	12,60	13.611	20,15	18.148	26,87	25.520	37,79	30.624	45,35
M 10	1	11.418	20,83	14.272	26,04	22.835	41,66	30.447	55,55	42.816	78,11	51.379	93,73
M 12	1,5	15.312	34,01	19.140	42,51	30.624	68,02	40.832	90,69	57.420	127,54	68.904	153,05
M 14	1,5	21.934	56,25	27.418	70,32	43.868	112,51	58.491	150,01	82.253	210,96	98.703	253,15
M 16	1,5	29.741	86,50	37.177	108,12	59.483	172,99	79.310	230,66	111.530	324,		

# FRICION VALUE $\mu_{ges}$ 0,16

Friction value  $\mu_{ges}$  0,16

Shank screws with metric ISO medium threads in accordance with DIN ISO 261

0,16	P mm	4.6		5.6		6.8		8.8		10.9		12.9	
		$F_{sp}$ N	$M_A$ N-m	$F_{sp}$ N	$M_A$ N-m	$F_{sp}$ N	$M_A$ N-m	$F_{sp}$ N	$M_A$ N-m	$F_{sp}$ N	$M_A$ N-m	$F_{sp}$ N	$M_A$ N-m
M 2	0,4	324	0,140	405	0,175	647	0,280	863	0,373	1.214	0,525	1.456	0,630
M 2,5	0,45	539	0,289	674	0,361	1.079	0,578	1.439	0,770	2.023	1,083	2.428	1,300
M 3	0,5	810	0,517	1.013	0,647	1.620	1,035	2.161	1,380	3.038	1,940	3.646	2,328
M 3,5	0,6	1.086	0,811	1.358	1,014	2.173	1,622	2.897	2,163	4.074	3,042	4.889	3,650
M 4	0,7	1.403	1,199	1.754	1,499	2.806	2,398	3.742	3,198	5.262	4,497	6.314	5,396
M 4,5	0,75	1.823	1,746	2.279	2,182	3.646	3,492	4.861	4,656	6.836	6,547	8.204	7,857
M 5	0,8	2.298	2,438	2.872	3,047	4.596	4,875	6.127	6,500	8.617	9,141	10.340	10,969
M 6	1	3.241	4,139	4.051	5,173	6.482	8,277	8.643	11,036	12.154	15,520	14.584	18,623
M 8	1,25	5.951	10,083	7.438	12,603	11.901	20,165	15.868	26,887	22.315	37,809	26.778	45,371
M 10	1,5	9.477	20,01	11.847	25,02	18.955	40,03	25.273	53,37	35.540	75,05	42.648	90,06
M 12	1,75	13.821	34,96	17.277	43,69	27.642	69,91	36.857	93,22	51.830	131,08	62.195	157,30
M 14	2	18.982	55,93	23.728	69,91	37.964	111,86	50.619	149,15	71.183	209,74	85.419	251,69
M 16	2	26.145	87,30	32.682	109,13	52.291	174,61	69.721	232,81	98.045	327,39	117.654	392,87
M 18	2,5	31.755	120,08	39.694	150,10	63.510	240,15	84.680	320,20	119.081	450,29	142.897	540,34
M 20	2,5	40.852	170,52	51.065	213,14	81.704	341,03	108.939	454,71	153.195	639,43	183.834	767,32
M 22	2,5	51.093	233,3	63.867	291,7	102.187	466,6	136.249	622,2	191.600	875,0	229.921	1.050,0
M 24	3	58.827	294,7	73.534	368,3	117.654	589,3	156.872	785,7	220.601	1.104,9	264.721	1.325,9
M 27	3	77.519	433,9	96.899	542,4	155.038	867,9	206.717	1.157,2	290.696	1.627,2	348.835	1.952,7
M 30	3,5	94.179	587,3	117.724	734,2	188.358	1.174,6	251.144	1.566,2	353.172	2.202,5	423.806	2.642,9
M 33	3,5	117.488	801,9	146.860	1.002,3	234.977	1.603,8	313.302	2.138,3	440.581	3.007,0	528.697	3.608,5
M 36	4	137.811	1.028,6	172.264	1.285,7	275.623	2.057,2	367.497	2.742,9	516.793	3.857,2	620.152	4.628,6
M 39	4	165.738	1.335	207.172	1.668	331.475	2.669	441.967	3.559	621.516	5.005	745.819	6.006
M 42	4,5	189.724	1.649	237.155	2.061	379.448	3.298	505.930	4.397	711.465	6.183	853.758	7.420
M 45	4,5	222.267	2.063	277.834	2.578	444.534	4.125	592.712	5.500	833.501	7.735	1.000.201	9.282
M 48	5	249.916	2.479	312.395	3.099	499.833	4.958	666.444	6.610	937.186	9.296	1.124.624	11.155
M 52	5	300.035	3.212	375.043	4.014	600.069	6.423	800.093	8.564	1.125.130	12.043	1.350.156	14.452
M 56	5,5	345.954	3.992	432.442	4.990	691.908	7.984	922.544	10.645	1.297.327	14.969	1.556.793	17.963
M 60	5,5	404.516	4.985	505.645	6.232	809.031	9.970	1.078.709	13.294	1.516.934	18.695	1.820.321	22.433
M 64	6	457.571	6.021	571.964	7.526	915.142	12.042	1.220.189	16.056	1.715.891	22.579	2.059.069	27.095
M 68	6	524.576	7.315	655.720	9.143	1.049.152	14.629	1.398.869	19.506	1.967.160	27.430	2.360.592	32.916

Shank screws with metric ISO fine-pitch thread in accordance with DIN ISO 261

M 8	1	6.536	10,91	8.170	13,64	13.073	21,83	17.430	29,10	24.511	40,92	29.413	49,11
M 10	1	10.976	22,64	13.720	28,29	21.952	45,27	29.270	60,36	41.161	84,88	49.393	101,86
M 12	1,5	14.707	36,83	18.383	46,04	29.413	73,66	39.218	98,22	55.150	138,12	66.180	165,74
M 14	1,5	21.080	61,07	26.351	76,34	42.161	122,14	56.214	162,86	79.052	229,02	94.862	274,82
M 16	1,5	28.598	94,08	35.748	117,60	57.196	188,16	76.262	250,88	107.243	352,80	128.692	423,35
M 18	1,5	37.260	137,20	46.575	171,50	74.519	274,40	99.359	365,87	139.724	514,51	167.669	617,41
M 20	1,5	47.065	191,8	58.831	239,7	94.130	383,6	125.506	511,4	176.494	719,2	211.792	863,0
M 22	1,5	58.014	259,2	72.517	324,0	116.027	518,4	154.703	691,2	217.551	971,9	261.062	1.166,3
M 24	1,5	70.106	340,7	87.632	425,9	140.212	681,5	186.949	908,6	262.897	1.277,7	315.477	1.533,3

Specifications given without warranty.













































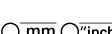









































## Legend

- $\mu_{ges}$  = Average friction value for thread and underhead seat
- P = Pitch of the thread
- $F_{sp}$  = Axial pre-tension force in the screw for 90% utilisation of the screw yield point (determined in accordance with the shape-changing-energy hypothesis)
- $M_A$  = Tightening torque during installation

## Important remarks

Please make sure to read our information relating to the guideline values of the thread friction values on page 640. Taking into consideration the friction values, the above-specified table values only apply for headless screws (expanding screws generally require lower tightening values). The effective friction diameter in the screw underhead seat was defined as 1.3 x external thread diameter. For this reason, it is only possible to use them in the case of normal shank screws, generally hexagon-headed and cylindrical-head screws (e.g. DIN EN ISO 4014, 4017, 4764, DIN 7984). When screws of high strengths (8.8 to 12.9) and tensed parts made of "soft" construction materials are used, a verification of the interfacial pressure under the screw head is strongly recommended.



	Weight (total)		Square drive (external)		Unit Drive hexagon
	Weight (total)				Unit Drive bi-hexagon
	Weight hammer head		Square drive (external)		Unit Drive
	Length (total)				Hexagon
	Length (total)		Square drive (external)		Bi-hexagon
	Length (total)		Square drive (internal)		Internal-TORX®
	Length (total)				Internal TORX® with pilot
	Length of blade				TORX PLUS®
	Length of blade		Square drive (internal)		External TORX®
	Length of shaft / handle				Internal serrations XZN
	Length of point / blade				Multi-spline RIBE®
	Diameter (also dia. of head, of shaft, of points)		Hexagon drive (external)		Female three-square
	Diameter		Hexagon drive (external)		TORQ-SET®
	Diameter of hole (external)				Tri-Wing®
	Diameter of hole (internal)		Hexagon drive (internal)		Cutting edge thickness
	Width across flats (Nominal Width)		Hexagon drive (internal)		Jaw width / tape width
	Width across flats (Nominal Width)				Head width
	Width across flats (Nominal Width)		Puller		VDE Test Symbol (Tool)
	Width across flats (Nominal Width)		Clamping spread		Test Symbol (Protective equipment)
	Width across flats (Nominal Width)		Clamping reach		For working in voltage areas up to 1000 V
	Width across flats (Nominal Width)		Size of spindle		Wire rope
	Width across flats (Nominal Width)		Hydraulic spindle		Jaws, angled 45°
	Width across flats (Nominal Width)		Throat depth		Flat jaws
	Width across flats (Nominal Width)		Opening capacity		Flat-round jaws
	Width across flats (Nominal Width)		Drive sections		Round jaws
	Width across flats (Nominal Width)		Slotted		Straight jaws
	Width across flats (Nominal Width)		Cross-slotted PH		Flat-round jaws
	Width across flats (Nominal Width)		Cruciform PZ		Round jaws
	Width across flats (Nominal Width)		Internal square		
	Thread size, connection thread		Hexagon internal		
	Screw dimension (type of thread)		Internal hexagon with tamper proof hole		
	Ratchet used		External hexagon		
	Ratchet used		Bi-hexagon external		
	Ratchet used				
	Ratchet used				
	Ratchet used				



# Customised for you!

Individual - precise - customised - flexible - right on!



- > Individual product design
- > All RAL colour tints can be produced



- > Foam configurator
- > Bespoke tool modules
- > Two-colour check tool inserts
- > Individual tool set for each insert



- > Extra-size tools
- > Mini batches: Production as of 1 item
- > Special-purpose tools



	Cutting edge with bevel		Drawer		Cylinder lock with folding key
	Cutting edge without bevel		Door		Total brake
	Straight jaws		Shelf		
	Angled jaws 45°		Pivoting angle		Length/crosswise dividers
	Angled jaws 90°		Angle		Individual blocking
	Internal retaining rings		Weld-on end fitting		Thickness of workplate
	External retaining rings		End fitting with hexagon wrench		Multi fitting key
	EPA / ESD, electrostatic discharge		Open end fitting		Magnetic lifting power
	Electronic		Flared end fitting		Stepped key
	File profile flat		Ring end fitting		Head height
	File profile three-edged		End fitting with square head		Head diameter
	File profile round		Bit holder end fitting		Friction ratchet
	File profile half-round		Ratchet end fitting		Sliding T bar
	File profile square		Anti-wind-up-ratchet		Extension
	Blade / Cutting edge width		Factory certificate		Universal joint
	Blade thickness		Visual display digital		Driving handle
	Gear ratio		RS 232 interface		Adaptor
	Output torque (max. N-m)		Bi-directional tightening		Handle
	Input torque (max. N-m)		Audible reaction (click)		Head
	Scale divisions		Mechanical torque multiplier		Dimension shaft
	Single square drive		Integrated electronic hardware		Dimension head/striking face
	Double square drive		DREMOMETER MINI-F operable w/o inaccuracies		Type of jaw
	Drive connector		1% Tolerance		POWER PLIERS
	Spigot-end drive		3% Tolerance		Tip diameter
	in cardboard or plastic packaging		4% Tolerance		Tip diameter
	in sheet metal box		6% Tolerance		Spread range
	Set in sheet metal or plastic box		Extension with release		new
	Head width		Release head		Safety symbols
	Distance, hole to edge		Click Tools		
	GS Seal of tested quality		Slipping Tools		
	magnetic		Breaking Tools		
	Radius		Central locking		
			Cylinder lock		

> Specific surface treatments possible  
> e.g. colour anodising and much more



> High-quality forgings based on your requirements  
> Special-purpose tools



> Special electronic product programming  
> Determining/implementing individual maintenance intervals (calibration/services)



<b>A</b>	
Accessories .....	635
Accessories for socket wrenches 1/2" .....	101, 109
Adaptor .....	124, 255
Adaptor pieces .....	255, 257
Adaptor set 1/4" - 3/4" .....	175
Adjustable spanner .....	138, 139, 140
Adjustable wrench .....	140, 572
Aluminium prybar .....	531
Aluminium reversible ratchet 1/2" .....	206
Aluminium reversible ratchet 3/8" .....	181
Angle benders no. 280 .....	634
Angled combination pliers .....	370
Anti-freeze tester .....	546
Anti-slip mat .....	25, 35
Applications of the GEDORE pipe cutters .....	598
Arc punch .....	560
Attention! .....	383
Automatic centre punch .....	526
Automobile workshop set .....	493
<b>B</b>	
Balance weight pliers .....	536
Ball bearing extractor .....	477
Ball bearing extractor PLUS .....	475
Ball bearing extractor set .....	60, 476, 477
Ball joint puller .....	487
Ball joint puller 1.73 .....	487
Base plate .....	37
Basic housing .....	315
Basic tool assortment in tool case .....	83
Basic tool set .....	68
Basic tool set 1/4" for motorbikes .....	164, 165
Basin wrench .....	610
Battery-terminal puller .....	458
Bending bar .....	530
Bending former .....	619, 620, 622, 623
Bending sets .....	629
Bending tool .....	530
Bending tool set .....	625, 626
Bending tools .....	624, 626, 628, 635
Bent nose telephone pliers .....	377
Bit adaptor .....	124
Bit adaptor 1/4" .....	255
Bit holder .....	255
Bit holder long .....	255
Bit reversible ratchet 1/4" .....	254
Bit reversible ratchet 5/16" .....	257
Bit screwdriver .....	254
Bit screwdriver 1/4" .....	254
Bit set 1/4" .....	253
BLACK DOUBLE OPEN ENDED SPANNERS .....	
and BLACK SPANNERS .....	137
Blacksmith's tongs .....	420, 521
Bodywork file .....	547
Bodywork lever .....	548
Bodywork spoon .....	548
Bodywork tool set .....	550
Bolt Cutter .....	380, 419, 420
Bolt extractor .....	558
Bolt extractor set .....	557
Bowden cable cutter/Wire rope cutter .....	380
Brake caliper brush .....	537
Brake caliper file .....	537
Brake spring pliers .....	537
Breaking torque wrench TBN .....	308
Brick cutting chisel .....	523
Bricklayer's chisel .....	523, 524
Bricklayer's hammer .....	513
Builder's hatchet .....	513
<b>C</b>	
Cable cutter .....	580
Cable end-sleeve pliers .....	392
Cable knife .....	562, 563
Cable shears .....	381, 579
Cable splitting wedge .....	594
Calibrating tool .....	603
Caliper face spanner .....	151
Car light tester .....	542
Carbide scriber .....	529, 556
Care regulation .....	383
Carpenter's hammer .....	513
Carpenter's hammer with magnet .....	513
Cartridge spanner .....	488
Centre punch .....	526
Chain grip wrench .....	410, 453
Chain pipe cutter .....	546
Chain pipe wrench .....	417
Chain pipe wrench BOSS .....	417
Changing of the crimping inserts .....	395
Chisel and punch set .....	528
Chisel holder empty .....	39
Chisel set .....	58, 103, 111
Circlip pliers .....	103, 111
Circlip pliers for external retaining rings .....	400, 401,
.....	402, 405
Circlip pliers for internal retaining rings .....	403, 404,
.....	405
Clamping yoke .....	466
Claw gripper .....	543
Club hammer .....	508, 509



Club hammer ROTBAND-PLUS .....	508	Crowbar .....	531
Cold chisel hammer .....	521	Crowfoot Spanners .....	144
Combination hammer KOMBI-PLUS R .....	517	CT Modules 2005 CT for XL volume drawers .....	112
Combination holding tool .....	151	Curved bearing scraper (Long scraper) .....	559
Combination pliers .....	371	Cutting range of the link pipe cutter no. 210015 .....	598
Combination ratchet spanner .....	123	Cylinder liner puller .....	484
Combination ratchet spanner set .....	99, 106, 107, 124	<b>D</b>	
Combination ratchet spanner set, reversible .....	124	De-solder tool .....	391
Combination spanner set .....	58, 98, 99, 105, 106, 113, 128	Deburrer .....	552
Combination spanner sets .....	126	Deep ring spanner .....	143
Combination Spanners .....	125, 126, 127, 128	Digital measuring calliper .....	555
Combination stepped key .....	611	Dismantling and assembly fork .....	489
Combination swivel head wrench .....	145	Distance module 1/3 empty .....	104
Concrete mesh and bolt cutter .....	420	Distance module empty .....	104, 105
Connector pliers .....	418	Distance module with small boxes .....	104
Construction ratchet .....	232	Divider set .....	45
Contact file .....	552	Double ended midget spanner .....	136
Convertor 1.1/2" to 2.1/2" .....	249	Double ended midget spanner set .....	136
Convertor 1" to 1.1/2" .....	247	Double ended ring spanner .....	131
Convertor 1/2" to 3/4" .....	217, 240	Double ended ring spanner set .....	131
Convertor 1/4" to 3/8" .....	174	Double Ended Ring Spanners .....	130
Convertor 3/4" to 1" .....	225, 243	Double ended socket wrench .....	147
Convertor 3/8" to 1/2" .....	191, 235	Double ended socket wrench set .....	114, 147
Copper hammer .....	520	Double flaring tool set .....	608
Copper hammer ROTBAND-PLUS .....	520	Double open ended spanner .....	134, 135, 137
Corner valve socket wrench .....	609	Double open ended spanner set .....	135
Counter-support brace .....	483	Double ring ratchet spanner .....	129
Coupler 1" .....	229	Drain plug wrench .....	537
Coupler 1/2" .....	217	DREMOPLUS ALU Family 2: DVI-20L/Z and DVI-28L/Z ...	338
Coupler 1/4" .....	174	DREMOPLUS ALU Family 3: DVV-13Z .....	340
Coupler 3/4" .....	225, 291, 295	Drift punch .....	526
Coupler 3/8" .....	191	Drift punch set .....	528
Craftsman scissors .....	564	Drill holster .....	565
Cranked Allen socket screwdriver .....		Drill-bit holder .....	38
for multi-point screws XZN .....	361	Drive shaft puller .....	488
Cranked screwdriver .....	363	Driving handle .....	254
Cranked socket key .....	361, 362, 363	Driving handle 1/4" .....	173
Cranked socket key set .....	361, 362	Duo pouch .....	566
Cranked socket key with 2C-T-handle .....	355	<b>E</b>	
Creeper .....	551	Eccentric angle bender .....	635
Crimp wrench .....	393, 394	Elbow pipe wrench ECK-SCHWEDE® .....	413
Crimping pliers set AUTOMOTIVE .....	398	Electricians tool case .....	71
Crimping pliers set DATA COM .....	398	Electricians' chisel .....	524
Crimping pliers set ELECTRONIC .....	398	Electricians' pouch .....	566
Crimping pliers set INDUSTRIAL .....	398	Electricians' side cutter .....	373
Crimping pliers set starter .....	399	Electricians' splitting chisel .....	524
Cross tweezers .....	556	Electronic diagonal cutter .....	386, 388
Cross-cut chisel .....	525	Electronic end cutting nipper .....	386
Crosswise divider .....	35	Electronic mini diagonal cutter .....	386
		Electronic Pliers .....	383



Electronic pliers set .....	383	Folding rule .....	556
Electronic screwdriver .....	352	Folding workbench .....	34
Electronic screwdriver set .....	353	for scrapers .....	559
Electronic side cutter carbide .....	385, 386	Four-way wheel wrench .....	534
Electronic torque tester DREMOTEST E .....	314	Friction ratchet handle without insert ring .....	231
Electronic torque wrench E-torc .....	312	Friction type ratchet .....	230
Electronic torque wrench TorcoTronic III .....	313	Function Recoiless hammer .....	515
Electronic torsion test device .....	315	Function TORCOFIX K .....	295
Embossing hammer .....	549	<b>G</b>	
End cutting nipper POWER .....	375	Gasket scraper .....	559
End fitting in-hex .....	319	GEDORE .....	380
Engineer's ball pein hammer with ball .....	507	GEDORE i-BOXX® 72 .....	62
Engineers' hammer .....	505, 506	GEDORE i-BOXX® Rack active .....	62
Engineers' hammer ROTBAND-PLUS .....	503	GEDORE Insetbox i3 .....	62
Extension 1" .....	229, 247	GEDORE L-BOXX® 136 with assortment Electrician .....	54
Extension 1/2" .....	216, 217, 240	GEDORE L-BOXX® 136 with assortment Installation .....	55
Extension 1/4" .....	173, 174, 233	GEDORE L-BOXX® 136 with assortment Mechanic .....	54
Extension 3/4" .....	224, 243	GEDORE L-BOXX® 136 with easy carry handle .....	62
Extension 3/8" .....	190, 235	GEDORE L-BOXX® Mini .....	63
Extension cable .....	633	GEDORE L-BOXX® Roller .....	62
Extension for 1.51/10 + 11 .....	470	GEDORE safety "extra" .....	408
Extension for hydraulic spindle .....	453	GEDORE spindles ... ..	452
Extension kit .....	598	Glaziers hammer .....	514
Extension rod .....	473	Grey cast iron bending former up to 90° .....	633
Extension tubes ALU for DREMOMETER A - CD .....	281	Grip wrench .....	407, 408
Extension tubes for DREMOMETER E - F .....	281	Grip wrench for glueing .....	409
Extractor .....	475	Grip wrench set .....	103
<b>F</b>		Grip wrench, long jaws .....	409
Fan puller .....	461, 462, 465	Grooving chisel .....	525
Features Material .....	480	GuStaV The world's safest hammer .....	510
Features Torque wrench with slave pointer Type 83 .....	310	<b>H</b>	
Feeler gauge set, fan pattern .....	554	2C-T-Handle .....	354
Figure snips .....	561	Hacksaw .....	553, 595
File brush .....	553	Half-moon ring spanner .....	133
Fine needle nose electronic pliers .....	387	Half-round blunt file .....	552
Fixed square head .....	319, 320	Hammer holder with metal hooks .....	565
Flange separators .....	491	Hand file .....	552
Flare nut spanner, open .....	133	Hand ratchet 1/4" .....	168
Flared end fitting .....	318	Hand-operated impact driver 1/2" .....	250
Flaring tool boerdex .....	606	Hand-operated impact driver set 1/2" .....	250
Flaring tool set boerdex .....	607	Handle types .....	505
Flat cold chisel .....	522	Hard metal tip flat scraper .....	559
Flat nose electronic pliers .....	388	Heavy-duty belt set .....	566
Flat nose pliers .....	376	Heavy-duty belt with cushion .....	565
Flat ring spanner .....	132	Heavy-duty cable stripping tool .....	391
Flat ring spanner set .....	132	Helving - made easy .....	504
Flat round face hammer .....	548	Hexagon Allen key .....	356, 357, 358, 359, 360
Flat scraper .....	559	Hexagon Allen key set .....	115, 356, 357, 358, 359, 360, 361
Flexible extension 1/4" .....	174	Hexagon Allen key with 2C-T-handle .....	354, 355
Flexible milled file blades .....	547		

Hexagon socket key set .....	101, 110	<b>J</b>	Joiners' hammer .....	507
High-speed pipe wrench .....	414	<b>K</b>	Key file set .....	552
High-speed swivel disc .....	217	Knee pads, pair .....	567	
Hobby saw .....	553	Kneeling board .....	551	
Holder .....	40	KOMBI-PLUS R .....	517	
Hole cutting snips .....	561	<b>L</b>		
Hook wrench .....	150, 151	L-BOXX® Mini .....	63	
Hose clamp pliers .....	540, 541	L-handle 1/2" .....	215	
Hose clamp pliers CLIC .....	541	L-handle 3/8" .....	190	
Hot chisel hammer .....	521	Lead hammer .....	520	
Hydraulic cylinder .....	470	Lengthwise divider .....	35, 114	
Hydraulic hand pump .....	469	Letter and number punches .....	551	
Hydraulic implements .....	469, 470	Lever-action end cutting nipper .....	375	
Hydraulic oil .....	633	Lever-action side cutter .....	375	
Hydraulic press .....	453	Lid tool board .....	62	
Hydraulic pressure spindle .....	453	Light metal hammer .....	520	
<b>I</b>		Lightweight power pack with 100% performance! .....	206	
Ideal pattern snips .....	561	Link pipe cutter .....	598	
Impact driver set .....	101, 110	Locking system .....	45	
Impact screwdriver bit socket 1" .....	247	Long nose electronic pliers .....	387	
Impact screwdriver bit socket 1/2" .....	238, 239	<b>M</b>		
Impact screwdriver bit socket 3/4" .....	243	Machine holder for battery screwdriver .....	38	
Impact socket 1.1/2" .....	248	Machine workbench clamp .....	409	
Impact socket 1" .....	246	Machine- or hand-operated... ..	244	
Impact socket 1" with Impact-Fix lock .....	245	Magazine handle screwdriver .....	254	
Impact socket 1/2" .....	236, 237, 238, 239	Magnetic lifter .....	543	
Impact socket 1/2" with protective sleeve .....	238	Magnetizer and demagnetizer .....	363	
Impact socket 1/4" .....	233	Manual bending tool set .....	619, 620, 621, 622, 623	
Impact socket 2.1/2" .....	249	max. bending capacities .....	634	
Impact socket 3/4" .....	242	Mechanic's tool assortment .....	76, 86, 87	
Impact socket 3/4" with Impact-Fix lock .....	241	Mechanics pliers .....	379, 415	
Impact socket 3/8" .....	234	Mini magnetic lifter .....	543	
Impact socket set 1/2" .....	236	Miniature electronic diagonal end .....		
Impact socket set 3/4" for trucks .....	241	cutting nippers .....	389	
Impact-Fix Lock .....	244	Miniature electronic flat nose pliers .....	390	
Industrial knife .....	562	Miniature electronic needle nose pliers .....	390	
Industrial pulling set .....	494	Miniature electronic side cutter .....	384, 385, 389, 390	
Industrial pulling set with leg brake .....	494	Miniature electronic wire stripping pliers .....	390	
Industrial scissors professional .....	564	Miniature pipe cutter MINI-QUICK .....	603	
Insert ring for friction ratchet .....	231	Miniature pipe cutter MINI-QUICK niro .....	601	
Inspection mirror .....	555	Mobile tool case .....	51	
Installation pliers .....	546	Mobile workbench .....	26, 28, 31, 33	
Installation tripod, pivotable .....	633	Mobile workbench extra width .....	27, 30	
Installation wrench .....	609	Modular crimp wrench .....	395	
Insulating tape .....	595	Module assortment large .....	94	
Insulating varnish stripper .....	391	Module assortment middle .....	93	
Internal extractor .....	480, 481, 482			
Internal extractor overview .....	480			
Internal extractor set .....	57, 480, 484, 485			
Internal knife .....	595			



Module assortment small .....	92	Pipe bending pliers .....	618
Module insert .....	396, 397	Pipe cutter .....	600, 602, 604
Module Systems - Flexibility with flair .....	327	Pipe cutter QUICK AUTOMATIC .....	602
Multi fitting key ELECTRO .....	150	Pipe cutter QUICK AUTOMATIC niro .....	600
Multi fitting key UNIVERSAL .....	150	Pipe cutter TUBEX .....	599
Multi fitting Master Key Unit .....	150	Pipe deburring reamer .....	601, 603
Multi-use cable knife .....	595	Pipe shears .....	605
Multiple pliers .....	378	Pipe wrench .....	413, 414
Mushroom head DREMASTER® DMK .....	291	Pipe wrench ECK-SCHWEDE-snap® .....	412
Mushroom head TORCOFIX K .....	295	Piston ring compressor .....	540
<b>N</b>		Piston ring pliers .....	540
Needle nose electronic pliers .....	387	Planishing / grooving hammer .....	549
NH-Fuse insertion glove with sleeve .....	593	Planishing hammer .....	548
Nut driver set .....	115	Planishing hand anvils .....	547
Nut driver with 2C-T-handle .....	356	Plastic cassettes empty for .....	
Nut driver with 3C-handle .....	347	DREMOMETER MINI + AM .....	327
Nut splitter .....	491	Plastic hammer .....	518
Nut splitter set .....	491	Plastic ratchet 1/2" .....	207
Nylon hammer .....	518	Plastic spare head .....	518
Nylon spare head .....	518	Pliers for external retaining rings .....	405
<b>O</b>		Pliers for valve seals .....	539
OFFSET .....	130	Pliers set .....	102, 111, 399, 421, 422, 423
Offsetting pliers with punch .....	550	Pliers/screwdriver assortment .....	59
Oil can .....	537	Plumber's wrench .....	611
Oil filter hook .....	488	Pocket knife .....	562
Open end fitting .....	317, 320, 321	Pocket vernier calliper .....	555
Open ended slogging spanner .....	143	Point chisel .....	524
Open ended spanner set .....	98, 106	Point pein hammer .....	549
Overview Contents Hook Assortments 1500 HS .....	40	Polyamide spare head (piece) .....	516
<b>P</b>		Polyamide spare head (piece) KOMBI-PLUS R .....	517
Pair of spare knives .....	382, 581	Power combination pliers .....	372
Paper roll holder .....	37	Power side cutter .....	373, 374
Parallel jaw grip wrench .....	409	POWERFUL .....	142
Parallel vice .....	554	Precision crimp wrench .....	393
Paring chisel .....	525	Precision mechanics .....	103, 111
Parts .....	476, 607, 608, 619, 620, 622, 623, 626	Precision stripping tool .....	392
Paving hammer square .....	514	Precision tweezers .....	556
Pelican pattern snips .....	561	Precision tweezers ESD .....	556
Pin punch .....	527	Professional plastic bearing installation set .....	455
Pin punch set .....	528	Profi-key universal .....	150
Pin punch set .....	527, 528	Profile-section grip wrench .....	410
Pincer .....	375	Protective hand guard .....	522
Pipe bending machine .....	627, 628, 629	Prybar .....	530, 531
Pipe bending machine 1" - 4" .....	633	Prybar set .....	531
Pipe bending machine 3/8" - 1.1/4" .....	630	Puller .....	457, 459, 460, 461, 462, 464, 466, 467, 468, 471
Pipe bending machine 3/8" - 2" .....	631	Puller set .....	103, 436, 437, 441, 442, 447, 448, 493
Pipe bending machine 3/8" - 3" .....	632		
Pipe bending machines 256-261 .....	630		

Puller set internal/external .....	56, 438	Ring end fitting .....	318, 320, 321
Puller TWIST + PULL .....	456	Ring slogging spanner .....	142
Puller with sliding hammer .....	465	Ring slogging spanner deep offset .....	143
Pulling flange .....	488, 489	Ring spanner set .....	59, 98, 105
Pulling leg .....	457, 458, 459, 461, 462, 463	Ring spanner set, short pattern .....	98, 105
Pulling set for construction machines .....	494	Rivet setter .....	529
Punch hammer .....	521	Rivetting setter .....	529
Punch pliers .....	550	Rivetting snap die .....	529
<b>Q</b>		Roll-cover .....	566
Quick-release puller .....	440, 444	Roller skids, pair .....	45
<b>R</b>		Round file .....	552
Radiator valve spanner .....	611	Round holder .....	38
Ratchet handle with coupler 1" .....	227	Round nose electronic pliers .....	388
Ratchet handle with coupler 1/2" .....	207	Round nose pliers .....	376, 377
Ratchet handle with coupler 1/4" .....	168	Rubber mallet .....	519
Ratchet handle with coupler 3/4" .....	221	<b>S</b>	
Ratchet handle with coupler 3/8" .....	182	3C-Screwdriver .....	345, 346, 347
Ratchet head .....	319, 321	3C-Screwdriver set .....	348, 349
Ratchet head DREMOMETER .....	281	3C-Screwdriver with striking cap .....	350
Ratchet heads DREMOMETER 754 .....	281	S-BOXX® W3 .....	45
Ratchet pipe cutter niro .....	546	Safety coil spring compressor .....	490
Ratchet with T-handle 1/4" .....	168	Safety cover size 1 .....	455
Ratchet with T-handle 3/8" .....	182	Safety Note! .....	383, 545
Rear panel .....	25, 34	Safety notes Pullers .....	495
Rear panel board .....	25, 34	Safety ring and safety pin .....	233, 235, 240, 243, 247, 249
Recoilless hammer .....	516	Safety-relevant .....	487
Rectangular bit holder .....	323, 326	Sanitary tool assortment PROFI .....	81
Rectangular fixed square head .....	323, 326	Sanitary tool assortment STARTER .....	80
Rectangular flared end fitting .....	322	Scaling hammer .....	514, 515
Rectangular handle SE .....	324	Scaling hammer ROTBAND-PLUS .....	514
Rectangular open end fitting .....	322, 325	Scraper .....	563
Rectangular reversible ratchet head .....	323, 326	Screw extractor .....	557
Rectangular ring end fitting .....	322, 325	Screw extractor set .....	557
Rectangular ring ratchet spanner, reversible .....	324	Screwdriver set .....	102, 110
Rectangular weld-on fitting .....	324, 326	Screwdriver .....	351
Reducer 1.1/2" to 1" .....	248	Screwdriver bit 1/4" .....	253
Reducer 1" to 3/4" .....	229, 247	Screwdriver bit 1/4", Value pack .....	251, 252, 253
Reducer 1/2" to 3/8" .....	217, 240	Screwdriver bit 5/16" .....	256, 257
Reducer 2.1/2" to 1.1/2" .....	249	Screwdriver bit socket 1" .....	228
Reducer 3/4" to 1/2" .....	225, 243	Screwdriver bit socket 1/2" .....	211, 212, 213, 214
Reducer 3/8" to 1/4" .....	191, 235	Screwdriver bit socket 1/4" .....	171, 172
Retaining clip for nuts .....	151	Screwdriver bit socket 3/4" .....	223
Reversible lever change ratchet .....	232	Screwdriver bit socket 3/8" .....	186, 187, 188
Reversible ratchet 1" .....	227	Screwdriver bit socket set 1/2" .....	100, 101, 109, 115, 195, 198, 199, 200, 201
Reversible ratchet 1/2" .....	204, 205, 206	Screwdriver bit socket set 1/2" + 1/4" .....	200
Reversible ratchet 1/4" .....	168	Screwdriver bit socket set 1/4" .....	160, 161
Reversible ratchet 3/4" .....	221	Screwdriver bit socket set 3/8" .....	179
Reversible ratchet 3/8" .....	181	Screwdriver bit socket set 3/8" .....	100, 108



Screwdriver bit socket set 3/8" + 1/4" .....	179	Socket set 1" .....	226
Screwdriver MaVo .....	576	Socket set 1/2" .....	58, 59, 100, 109, 112, 115, 192, 193, 194, 195, 196, 197, 198, 199, 201, 202, 203
Screwdriver set .....	102, 114, 115, 351	Socket set 1/2", hexagon .....	100, 108
Scriber .....	556	Socket set 1/2", UD profile .....	100, 108
Seaming pliers .....	418	Socket set 1/4" .....	58, 59, 99, 107, 113, 160, 162, 164, 165, 166, 167
Separator .....	473	Socket set 1/4"-1/2" .....	197, 198
Separator and puller set .....	57, 474	Socket set 1/4"-3/8"-1/2" .....	112
Separator puller .....	472	Socket set 3/4" .....	113, 219, 220
Set combination swivel head wrenches .....	99, 107	Socket set 3/8" .....	100, 108, 113, 114, 176, 177, 178, 179, 180
Set impact sockets 1/2" .....	101	Socket set 3/8" + 1/4" .....	178
Set of arc punches .....	560	Socket wrench set .....	99, 107
Set of circlip pliers .....	424, 425	Socket Wrenches .....	146
Set of internal and external extractors .....	485, 495	Soft face cap .....	507, 509
Set of open flare nut spanners .....	98, 105	Spanner holder .....	39
Set of pulling legs .....	478	Spanner set Mini .....	139
Set of rivetting setters and snap dies .....	529	Spare chain .....	417
Set of spares .....	414	Spare chain BOSS .....	417
Set of spares for wire rope cutter .....	380	Spare cutting head .....	420
Set of spark plug sockets 3/8" .....	545	Spare handle .....	505, 505, 512, 514
Set of threaded inserts .....	492	Spare handle ash .....	518, 519, 548
Setting punch .....	530	Spare handle for club hammers .....	508
Shears set .....	605	Spare handle hickory .....	507, 516
Sheet metal case empty for DREMOMETER A-F .....	327	Spare handle hickory KOMBI-PLUS R .....	517
Shelf .....	39	Spare handle ROTBAND-PLUS .....	508, 511
Side cutter .....	373	Spare handle ROTBAND-PLUS for engineers' hammers .....	504
Single ended ring spanner .....	141	Spare jaws (pair) .....	417
SK = socket short .....	203	Spare jaws for parallel vice .....	554
SK Ratchet and sockets .....	203	Spare leg for 1.30/10 .....	480
Sledge hammer .....	510, 512	Spare parts .....	546, 598, 599, 600, 601, 602, 603, 604, 605
Sledge hammer ROTBAND-PLUS .....	511	Spare rubber suction cup .....	539
Sliding hammer .....	483	Spare strap .....	538, 610
Sliding T bar 1" .....	229	Spare tapered collar .....	504
Sliding T bar 1/2" .....	215	Spare tips .....	405
Sliding T bar 1/4" .....	173	Spark plug brush .....	545
Sliding T bar 3/4" .....	224	Spark plug gauge .....	555
Sliding T bar 3/8" .....	189	Spark plug socket .....	544
Sliding T bar with release 1/2" .....	216	Spark plug socket 3/8" .....	545
Sliding T bar with release 3/8" .....	189	Spark plug socket wrench .....	544, 545
SLIM DRIVE .....	576	SPECIAL .....	133, 144
SLIM LINE .....	127	Special grip wrench .....	409
Small saw for metal .....	553	Special siphon pliers .....	610
Small saw for metal PUK .....	553	Special strap wrench .....	538
Small universal scissors .....	564	Special water pump pliers .....	416
Smoothing hammer .....	549		
Socket 1" .....	228		
Socket 1/2" .....	204, 208, 209, 210		
Socket 1/4" .....	169, 170		
Socket 3/4" .....	222, 223		
Socket 3/8" .....	183, 184, 185		
Socket holder .....	39, 255		



Speed brace 1/2" .....	215	The toggle lever – A giant among the joints .....	407
Speed brace 3/8" .....	189	Thread file .....	557
Spindle pressure pads .....	454	Thread gauge .....	555
Spindle summary .....	452	Three-edged bearing scraper .....	559
Splitting chisel .....	523	Three-edged flat ground scraper .....	559
Spring clamp .....	37	Three-edged hollow ground scraper .....	559
Spring spreader .....	490	Three-pouch belt set .....	566
Spring steel socket rail 1/2" .....	218	Three-square scraper .....	559
Spring steel socket rail 3/8" .....	191	Thrust-carrying member for hydraulic spindle .....	453
Square bladed awl .....	363	Tile chisel .....	525
STARTER Tool kit .....	55	Tiler's setting tool .....	529
Steel bending former up to 90° .....	634	Tin snips .....	561
Steel rule .....	555	Tommy bar .....	144
Steel tape measure .....	556	Tool assortment .....	82
Steering-wheel puller .....	489	Tool assortment AUTODOCTOR .....	68, 74
Stepped key .....	611	Tool assortment CARS .....	90
Stepped tommy bar .....	148, 149	Tool assortment for construction machines .....	89
Storage tray .....	39	Tool assortment for Mechanical Engineers .....	85, 589
Strap wrench .....	538, 610	Tool assortment for tractors .....	83
Stripping pliers .....	382, 392	Tool assortment HGTV .....	84
Stripping pliers STRIP-FIX .....	382	Tool assortment INCH .....	88
STRONG .....	141	Tool assortment NFZ .....	91
STRONG AND ACCURATE .....	134	Tool assortment TOURING .....	74
Stud extractor .....	491	Tool board with pliers/screwdriver assortment .....	61
Stud screw inserter .....	609	Tool board with VDE pliers/screwdriver assortment .....	61
Stud screw wrench .....	609	Tool box .....	48, 49, 50
Suction cup lifter .....	542, 543	Tool box JUMBO .....	50
Summary of puller legs .....	450	Tool box module WorkMo W2 .....	44
Supplementary tool assortment .....	78	Tool box module WorkMo W3 .....	44
Swivel handle 1/2" .....	215	Tool box with tool assortment .....	72, 73
Swivel handle 1/4" .....	173	Tool boxes .....	48
Swivel handle 3/4" .....	224	Tool cabinet .....	36
Swivel handle 3/8" .....	189	Tool case electrician .....	70, 75, 591
Swivel handle with sliding T 1/2" .....	215	Tool case empty .....	51
Swivel head reversible ratchet 1/2" .....	206, 207	Tool case large .....	51
Swivel head reversible ratchet 3/8" .....	182	Tool case TOURING .....	69
Swivel head wrench double ended .....	145	Tool chest .....	24, 49
Swivel head wrench set .....	99, 107	Tool holder .....	37, 38, 39
Swivel socket 3/8" .....	185	Tool holding rail, magnetic 1/2" .....	218
<b>T</b>		Tool holding rail, magnetic 1/4" .....	175
Tap and die set .....	558	Tool holding rail, magnetic 3/8" .....	191
Tap wrench with ratchet .....	558	Tool hook .....	37
Taper punch .....	530	Tool module 1/4" .....	108
Technical information .....	280	Tool module empty .....	104
Technical information Quick-fitting change .....	284, 297	Tool panel .....	36
Technical information Z .....	283, 296	Tool rucksack PROFI .....	567
Telephone pliers .....	377, 378	Tool rucksack SOFT .....	567
Telescopic extension 1/4" .....	174	Tool set .....	114
THE DOUBLE WITH RATCHET .....	129	Tool tray .....	39
THE STRONG ALL-ROUNDER .....	125	Tool trolley .....	16, 18, 21, 22, 23





Tool trolley WorkMo W2 .....	43	Triangular file .....	552
Tool trolley WorkMo W3 .....	43	Truck workshop set .....	493
Tool trolley workster smartline .....	20	Tube holder .....	38
Tool vest .....	567	Tubular box spanner .....	148, 149
Torque angle indicator .....	316	Tubular box spanner set .....	148, 149
Torque angle indicator 8200 .....	316	Tweezers .....	556
Torque Multiplier DREMOPLUS ALU ...	335, 336, 337, 339, 341	two ball ends - 42 DKEL - The first with .....	356
Torque screwdriver .....		Tyre lever .....	536
Technical features .....	299	Tyre removing tool .....	490
Torque screwdriver Type FS .....	301	<b>U</b>	
Torque screwdriver Type PGNE FS .....	301	Under-gloves .....	593
Torque screwdriver Type PGNP FS .....	300	Universal 4-way wheel wrench .....	535
Torque screwdriver Type PGNS FS .....	300	Universal ball joint puller .....	487
Torque screwdriver Type S .....	302, 303	Universal cable knife .....	595
Torque screwdriver Type SP .....	303	Universal coil spring compressor .....	490
Torque screwdrivers 756 .....	302	Universal extension 1/2" .....	216
Torque wrench DREMASTER® K .....	290	Universal extension 1/4" .....	174
Torque wrench DREMASTER® SE .....	293	Universal extension 3/8" .....	190
Torque wrench DREMASTER® UK .....	291	Universal extension with magnetic effect .....	218
Torque wrench DREMASTER® Z .....	292	Universal filter wrench .....	538
Torque wrench DREMOMETER .....	268, 269, 270, 271,	Universal joint 1" .....	229, 247
.....	272, 273, 274, 275, 276,	Universal joint 1/2" .....	217, 240
.....	277, 278, 279, 280	Universal joint 1/4" .....	174
Torque wrench DREMOMETER A+S .....	285	Universal joint 3/4" .....	225, 243
Torque wrench DREMOMETER MINI .....	282	Universal joint 3/8" .....	191, 235
Torque wrench DREMOMETER SE A+S .....	287	Universal knife .....	563
Torque wrench DREMOMETER SE .....		Universal pipe bender .....	624
with quick-fitting change .....	284	Universal pliers .....	415, 416, 541
Torque wrench DREMOMETER T-FS .....	282	Universal pouch .....	565
Torque wrench DREMOMETER Z A+S .....	286	Universal prybar .....	530
Torque wrench DREMOMETER Z .....		Universal puller .....	433, 438, 439 441,
with quick-fitting change .....	283	.....	443, 445, 446, 449
Torque wrench for pre-setting TORCOFIX FS .....	298	Universal puller HIGH POWER .....	435, 436
Torque wrench set DREMASTER® K .....	290	Universal puller set .....	56, 437
Torque wrench set DREMASTER® SE .....	293	Universal tool assortment .....	77, 79
Torque wrench set DREMASTER® Z .....	292	<b>V</b>	
Torque wrench TORCOFIX K .....	295	Valve feeler gauge .....	555
Torque wrench TORCOFIX SE .....	297	Valve grinder .....	539
Torque wrench TORCOFIX Z .....	296	Valve holder venti-quick .....	609
Torque wrench TSC SLIPPER .....	306	Valve lapping tool .....	539
Torque wrench TSN SLIPPER .....	305	Valve spring compressor .....	539
Torque wrench TSP SLIPPER .....	306	VDE Bent nose telephone pliers .....	586
Torque wrench Type 88 .....	309	VDE Cable knife .....	594
Torque wrench with slave pointer Type 83 .....	310	VDE Cable shears .....	580
Torque wrenches with slave pointer .....	310	VDE electricians' safety gloves .....	593
TORX® Gauge .....	363	VDE Electricians' side cutter .....	584
Tower pincer .....	375	VDE Extension 1/2" .....	574
Track alignment gauge .....	490	VDE Extension 3/8" .....	573
Transport frame .....	50	VDE Flat nose pliers .....	585
Tray .....	39	VDE Heavy duty combination pliers .....	582

VDE Heavy duty end cutting nippers .....	584	Wide jaw grip wrench .....	409
VDE Hexagon Allen key .....	575	Wing protector .....	551
VDE Hexagon Allen key with T-handle .....	575	Wire brush .....	553
VDE Insulation mat .....	593	Wire stripping knife .....	391
VDE meter connection fittings .....	594	Wire twisting pliers .....	418
VDE Multiple pliers .....	581	Wood plate .....	25, 45
VDE Plastic clamp .....	593	Wooden mallet .....	519
VDE pliers set .....	103, 111, 588	Work gloves FastFit .....	565
VDE Pliers set with VDE dipped insulation .....	587	Work gloves M-Pact .....	565
VDE Pliers set with VDE insulating sleeves .....	587	Work knife .....	562
VDE Power side cutter .....	584	Workbench with tool cabinet .....	32
VDE Reversible ratchet 1/2" .....	575	Working principle Eck-Schwede-snap® .....	
VDE Reversible ratchet 3/8" .....	573	- the swedish original .....	412
VDE Round nose pliers .....	585	Wrecking bar .....	531
VDE Rubber cover sheet .....	593	Wrench for plumbing fittings .....	610
VDE Screwdriver .....	575, 576, 578	Wrench key with 2C-T-handle .....	355
VDE Screwdriver bit socket 1/2" .....	574	<b>X</b>	
VDE Screwdriver bit socket 3/8" .....	573	X-GRIP .....	406
VDE Screwdriver set .....	102, 111, 579	X-GRIP Circlip pliers .....	406
VDE Screwdriver set SLIM DRIVE .....	577, 578	X-GRIP Circlip pliers set .....	406
VDE Screwdriver SLIM DRIVE .....	576, 577	X-GRIP Parts .....	406
VDE Screwdriver SLIM DRIVE PlusMinus .....	578		
VDE Side cutter .....	582, 583		
VDE Single ended ring spanner .....	572		
VDE Single open ended spanner .....	572		
VDE Socket 1/2" .....	574		
VDE Socket 3/8" .....	573		
VDE Socket wrench .....	572		
VDE Stripping pliers .....	580		
VDE Stripping pliers STRIP-FIX .....	581		
VDE T-handle .....	574		
VDE Telephone pliers .....	586		
VDE Tool assortment .....	76, 590		
VDE Tool assortment HYBRID .....	592		
VDE Tool set .....	587, 588, 592		
VDE Torque wrench 1/2" .....	573		
VDE Universal pliers .....	581		
Voltage tester .....	542, 579		
Voltage tester 1000 V .....	579		
<b>W</b>			
2-way wheel wrench for cars .....	535		
4-way wheel wrench for cars .....	535		
4-way wheel wrench for small trucks .....	534		
4-way wheel wrench for trucks .....	534, 535		
Water pump pliers .....	416		
Welder's grip wrench .....	410		
Welder's grip wrench for tubes .....	410		
What is so special about GEDORE striking tools? .....	522		
Wheel socket wrench for trucks .....	536		
Wheel-hub puller .....	486		



1.04	433	1.19	465	1.90	491
1.04 / B	433	1.19 / SH	465	1.91	490
1.04 / HP	435	1.19 / XS	466	1.92	475
1.04 / HP-B	435	1.20	468	1.92	476
1.04 / HP-B-HSP	436	1.22	468	1.92	475
1.04 / ST	436	1.23	467	1 B -	125
1.04 / ST-HP-B	437	1.23 / XS	467	1 B (AF)	126
1.06	438	1.26	491	1 B (MM)	125
1.06	439	1.26 / HYD	491	1 B (MM) / 1 B (AF)	126
1.06 / AS	441	1.26 / K	491	1 B (WW)	126
1.06 / B	439	1.28	491	2.10	493
1.06 / E	440	1.29	477	2.20	493
1.06 / H	471	1.29	478	2.30	494
1.06/HSP	453	1.30 / 0-9	481	2.30-B	494
1.06 / HSP-B	441	1.30 / 10	482	2.40	494
1.06 / HSP-D	453	1.30 / N	481	2.50	495
1.06 / HSP-V	453	1.31	485	2	130
1.06 / S-E	440	1.32	485	2	131
1.06 / ST	442	1.34	480	2 A	141
1.07	443	1.34 / 1 - 1.34 / 4	480	2 AR	141
1.07/4	445	1.34 / 10	480	2 ATM	141
1.07 / 4-B	446	1.35	483	2 B	131
1.07 / 4-HSP-B	446	1.36	483	3.01	490
1.07 /AS	447	1.37 / 2	484	4	132
1.07 / B	443	1.38	472	4 E + 4 H	505
1.07 / E	444	1.38 / V	473	4 K	506
1.07 / HSP-B	445	1.38 + 1.40	472	4 R	129
1.07 / K	447	1.40	473	4 R (MM) / 4 R (AF)	129
1.07 / K-B	448	1.41	474	5.10	455
1.07 / K-HSP	448	1.50	469	6	134
1.07 / K-SE	447	1.50 / 1	469	6 (AF)	135
1.07 / K-SE S	448	1.51	470	6 (MM)	134
1.07 / S-E	444	1.51 / V	470	6 (MM) / 6 (AF)	135
1.08	449	1.55	453	6 NA	507
1.09	456	1.60	486	7	127
1.10	457	1.61	486	7 (AF)	127
1.11	457	1.62	486	7 (MM)	127
1.12	458	1.64	488	7 (MM) / 7 (AF)	128
1.12	459	1.65	488	7 R	123
1.13	458	1.66	489	7 R-005	124
1.13	459	1.67	489	7 R-012	124
1.14	460	1.68	489	7 RA	124
1.14 / L	461	1.70	489	7 RB	124
1.15	460	1.72	487	7 UR	123
1.15 / H	471	1.73	487	7 UR-005	124
1.15 / HSP	461	1.74	487	7 UR-012	124
1.15 / L	462	1.75 / 1	488	7 XL	128
1.16	462	1.76 / 1	488	8 (MM)	136
1.17	463	1.78 / P	490	8-0100	136
1.17 / H	471	1.78 / S	490	8-011	136
1.17 / HSP	463	1.79	490	9 E + 9 H	512
1.18	464	1.80	454	9 F	512
1.18	465	1.81 / 1 + 2	492	9 GuStaV	510
1.18 / 1.19	493	1.81 / 10 + 20	492	18 E	514
1.18 / XS	466	1.81 / K	492	19	208
1.19	464	1.85 / 1	455	19 EMU / D 19 EMU	193

19 IMU / D 19 IMU	196	32	222	94 ST	513
19 JMU / D 19 JMU	192	32 EM / D 32 EM	219	95	522
19 KMU / D 19 KMU	192	32 FM / D 32 FM	219	96	525
19 L	208	34	145	97	522
19 LMU-10	194	36	538	98	525
19 RMU-10	195	36 Z	538	99	526
19 SK	204	37	538	100	412
19 SKU-20	203	37 E	521	100	526
19 TMU / D 19 TMU	193	37 V	538	100 A	526
19 TX 20	200	38	536	101	526
19 V20U-10	197	38	562	103	523
19 V20U-20	198	38 E	521	104	523
19 VMU / D 19 VMU	194	39	536	104/TE	450
20 (AF)	169	40	150	106 - 106 D	528
20 (MM)	169	40 Z	151	106 / B	450
20 E + 20 H	508	41 - 41 B	232	106 / E	450
20 EAU-3	166	41 E	515	106 / N	450
20 EM	166	41 V - 41 BV	232	106 / S - 108 / XS	450
20 F	509	42	562	106 / SE	450
20 IMU-3	167	42 (AF)	359	106 / VB	450
20 ITU-3	167	42 (AF)	360	106 / XSE	450
20 L (AF)	169	42 (MM)	359	107	528
20 L (MM)	169	42 DKEL	356	108 UNI	522
20 LMU-10	165	42 DKEL	357	109	523
20 ST	509	42 EL (AF)	358	110	524
20 XLU-3 T	164	42 EL (MM)	358	110	457
21	509	42 KEL	357	110 HS	524
21 F	520	42 X	361	111	524
22 H	520	42 Z	360	112	524
25	146	43	361	112	458
25 PK	147	43 KTX	363	112	459
25 PK-012	147	43 TX	362	112 A	524
25 V	146	43 TX-09	362	112 S	524
26 D	144	44	151	113 - 113 D	528
26 R	149	45 E	150	114	527
26 RS	149	45 P	150	114	461
27	536	45 S	150	114 / L	462
28 CU	534	45 U	150	115	527
28 LM - LV	534	50 - 57	544	116	463
28 LR + 28 LRV	535	50 MH - 59 MH	544	116 A - 116 L	527
28 PKH	535	56 E	521	117	562
28 PR + 28 PRV	535	0059 - 0067	562	119	527
28 PU + 28 PUV	535	60 CP	139	119 L	528
29	232	60 P	139	120	417
30 (AF)	183	60 S	140	120	531
30 (MM)	183	62 P	140	121 G	543
30 GMU / D 30 GMU	177	63	562	121 G-3	543
30 HMU / D 30 HMU	176	65 E	507	121-2	542
30 IMU	177	72 H	514	121-3	542
30 JMU / D 30 JMU	176	75 GSTM	513	122	417
30 TX 20	179	75 ST + 75 STM	513	122	531
31 K	231	75 STKM	513	123	531
31 KR	230	77 E	514	124	531
31 KVR	230	77 ST	515	124	539
31 R	231	90 HS	529	125	540
31 VR	231	93 ST	513	125 B	529



126	529	147	351	259 - 260	632
126	540	147-04	351	260	550
126	610	147-162-05	351	261	548
127	529	148	351	261	633
127	540	149	363	268	633
128	525	151	531	269	547
128	539	152	414	269	633
129	525	156 S	363	269 F	547
130	559	162	351	272 - 273	549
130 / 10	482	164 IN	352	275 - 276	549
131	559	165 PH	352	276	624
132	540	165 TX	352	277	549
132	559	165 TX-06	353	278	549
132 CLIC	541	165-171-06	353	280	550
132-2	540	169	254	280	634
132-3	541	171 IS	352	280	635
132-4	541	173	363	289 - 291	548
133	143	174	363	291	563
133 D	559	175	413	292 - 293	548
133 F	559	175	563	298	537
133 H	559	176	413	298-04	537
133 K	559	179	563	299	537
134	541	202	525	304	418
134	559	203	525	304 / 304 (AF)	133
134 B	541	206	529	305	418
134 K	559	208	529	306 (MM) / 306 (AF)	142
135	530	210	598	306 G	143
135	537	220	599	308	143
136 BM	409	222	599	312	609
136 K	410	223 H	520	314	609
136 K	455	224	546	320	610
136-500	530	224 E	518	329	610
137	407	225	414	365	563
137	408	225 E	518	376	611
137 KR	409	226 E	519	380	611
137 MSP	409	227	414	400	133
137 P	409	227 E	519	400 (MM) / 400 (AF)	133
137 T	409	228	519	401	553
137-600	530	229	519	403	553
138	410	230	420	404	553
138 X	410	231	420	406	553
138 Y	410	233	420	407	553
138 Z	410	239	603	409 - 410	554
138-400	530	246	562	411	554
139	409	247 H	517	420	561
139-400	530	248 F	516	421	561
140	557	248 H	516	422	561
140-380	530	248 ST	516	423	561
141	531	249	627	424	561
142	415	250	628	425	561
142-430	531	250	629	500 F	506
143	415	251	548	500 ST	506
144	415	252 - 288	547	501 M	68
145	416	254	633	513	563
146	416	256	630	534	145
146 B	416	257 - 258	631	600 E + 600 H	503

600 IH	503	721	556	1100-1.41 / 2A	474
609 H	511	722-1	556	1100-1094	592
614	546	722-1 ESD	556	1100-2431	619
620 - 630	255	722-2	556	1100-2456	625
620 E + 620 H	508	745	556	1100-2456	626
620-024	253	746	556	1100-2786	621
622 H	520	753	282	1100-2788	622
625 A	139	754	281	1100-BASIC	55
625 M	139	755	301	1101 K	62
626	148	756	302	1101 L	62
626 S	148	757	303	1101-001	425
637	151	758	303	1101-002	423
639	151	759	305	1101-003 VDE	587
640	543	760	308	1101-004	425
641	543	761	306	1101-1.29 / 1K	60
642 SP	543	762	306	1101-1.29 / 1K	474
643	537	763	282	1101-1.29 / 3K	60
644 - 646	553	871	257	1101-1.29 / 3K	475
645	553	880	257	1101-142-2150	59
647	545	885	256	1101-19	59
648	545	885 X	257	1101-2333	607
652	539	887 TX	256	1101-2340	608
653	539	890	256	1101-2785	620
654	539	890 PZD	256	1101-5705	560
670	254	894 (MM)	138	1101-7-7 R	59
670 K	254	895 (MM)	137	1101-D 20	59
671	254	895 & 894 "Black spanners"	137	1102 L	63
673	255	905	551	1102 L	63
673 K	255	906	551	1102-001	425
673 L	255	907	551	1102-002 VDE	588
674	254	920	565	1102-003	423
676	254	922	565	1102-004 VDE	588
677 H	514	1000	69	1102-005 VDE	588
680	252	1021	353	1102-006 VDE	588
685	251	1050	68	1102-007	423
685 K	251	1090	70	1102-008	423
685 X	253	1090	591	1104	564
686	252	1091	71	1110 WM 221	44
687 TX	252	1100 CT1-19	58	1110 WM 24	44
688 TX	252	1100 CT1-20	58	1110 WM 321	44
689 TS	253	1100 CT1-350	58	1110 WM 34	44
690	251	1100 CT1-7	58	1110 WMHP 2	45
690 PZD	251	1100 L	62	1110 WMHP 3	45
699	255	1100 R	62	1110 WMR 23	45
699 L	255	1100 W-001	61	1110 WMS 23	45
700	255	1100 W-002 VDE	61	1110 WMSB 3	45
702	554	1100-01	54	1110 WMT 23	45
703 M	555	1100-02	54	1110 WMW-2	43
705 M	555	1100-03	55	1110 WMW-3	43
706	555	1100-1,04	437	1263	72
708	363	1100-1.04	56	1263 L	48
710	555	1100-1.04 / 12A	56	1265	72
711	555	1100-1.04 / 12A	438	1265 L	49
717	555	1100-1.30	57	1277	564
718	555	1100-1.30	484	1335	73
720	556	1100-1.41 / 2A	57	1335 L	49



1350 .....	564	1500 ED-70 XL .....	104	1500 H 31 .....	38
1370 Z .....	50	1500 ED-85 .....	105	1500 H 33 .....	38
1400 L .....	36	1500 ES-1 B .....	98	1500 H 34-14 .....	38
1401 L .....	36	1500 ES-1.07 .....	103	1500 H 37 .....	39
1410 L .....	49	1500 ES-137 .....	103	1500 H 38 .....	39
1420 L .....	49	1500 ES-145 .....	102	1500 H 39 .....	38
1430 .....	24	1500 ES-19 .....	100	1500 H 4 .....	37
1440 .....	50	1500 ES-19 IS .....	100	1500 H 5 .....	37
1440 Z .....	50	1500 ES-1993 T .....	101	1500 H 9 .....	39
1441 Z .....	50	1500 ES-1993 U-20 .....	101	1502 .....	33
1450 L .....	36	1500 ES-2 .....	98	1504 .....	28
1500 CT1-142 .....	111	1500 ES-2 B .....	98	1504 .....	29
1500 CT1-19 .....	108	1500 ES-20 .....	99	1504 XL .....	30
1500 CT1-19 IS .....	109	1500 ES-2133 .....	99	1506 XL .....	27
1500 CT1-1993 T .....	109	1500 ES-2150 PH .....	102	1505 .....	26
1500 CT1-1993 U-20 .....	109	1500 ES-2150 PZ .....	102	1578 .....	23
1500 CT1-2 .....	105	1500 ES-2163 TX .....	102	1580 .....	22
1500 CT1-2 B .....	105	1500 ES-2163 TXB .....	102	1930 .....	217
1500 CT1-20 .....	107	1500 ES-30 .....	100	1932 .....	217
1500 CT1-2133 .....	107	1500 ES-34 .....	99	1940 .....	217
1500 CT1-2150 PH .....	110	1500 ES-350 .....	103	1981 K .....	215
1500 CT1-2150 PZ .....	110	1500 ES-400 .....	98	1985 .....	215
1500 CT1-2163 TX .....	110	1500 ES-534 .....	99	1987 .....	215
1500 CT1-2163 TXB .....	110	1500 ES-6 .....	98	1987 A .....	216
1500 CT1-30 .....	108	1500 ES-7 .....	98	1990 .....	216
1500 CT1-34 .....	107	1500 ES-7 R .....	99	1990 A .....	216
1500 CT1-350 .....	111	1500 ES-7-32 .....	99	1990 KR .....	216
1500 CT1-400 .....	105	1500 ES-711 .....	103	1990 M .....	217
1500 CT1-534 .....	107	1500 ES-8000 .....	103	1990 M .....	218
1500 CT1-6 .....	106	1500 ES-D 19 .....	100	1993 ALU-10 .....	206
1500 CT1-7 R .....	106	1500 ES-DT 2142 .....	101	1993 GU-10 XL .....	207
1500 CT1-7 RA .....	106	1500 ES-IN 19 LKM .....	100	1993 GU-3 .....	206
1500 CT1-7 UR .....	106	1500 ES-ITX 19 LKP .....	101	1993 U-10 K .....	207
1500 CT1-7 URA .....	107	1500 ES-ITX 30 .....	100	1993 U-10 L .....	205
1500 CT1-711 .....	111	1500 ES-K 19 L .....	101	1993 U-10 T .....	205
1500 CT1-8000 .....	111	1500 ES-K 1900 .....	101	1993 U-20 .....	205
1500 CT1-D 19 .....	108	1500 ES-VDE 145 .....	103	1993 U-20 G .....	205
1500 CT1-IN 19 LKM .....	109	1500 ES-VDE 2170 PZ .....	102	1993 U-20 SK .....	204
1500 CT1-INX 19 LK .....	109	1500 H 0 .....	37	1993 U-3 .....	206
1500 CT1-ITX 19 LKP .....	109	1500 H 1 .....	37	1993 Z-94 .....	207
1500 CT1-ITX 30 .....	108	1500 H 10 .....	39	1994 .....	217
1500 CT1-K 1900 .....	110	1500 H 13 .....	25	1995 .....	217
1500 CT1-VDE 142 .....	111	1500 H 13 .....	35	1996 - 1997 .....	215
1500 CT1-VDE 2170 PZ .....	111	1500 H 18 .....	37	1998 .....	215
1500 CT2-1 B .....	105	1500 H 19 .....	38	2004 .....	18
1500 CT2-7 .....	106	1500 H 2 - 1500 H 3 .....	37	2004 .....	19
1500 CT2-7-32 .....	106	1500 H 20 .....	37	2004 HP .....	25
1500 CT2-DT 2142 .....	110	1500 H 21 .....	38	2005 .....	16
1500 CTD-20 BIT .....	108	1500 H 22 .....	38	2005 .....	17
1500 E-N L .....	104	1500 H 23 .....	38	2005 CT2-119 .....	114
1500 E-S L .....	104	1500 H 24 .....	38	2005 CT2-2133 T .....	115
1500 ED-150 K .....	105	1500 H 25-3 .....	39	2005 CT2-2142 TX .....	115
1500 ED-30 .....	104	1500 H 27 .....	39	2005 CT2-2143 KTX .....	115
1500 ED-70 .....	104	1500 H 28 .....	39	2005 CT2-2160 .....	114
1500 ED-70 K .....	104	1500 H 29 .....	37	2005 CT2-25PK .....	114
1500 ED-70 S .....	104	1500 H 30 .....	37	2005 CT2-D 19 .....	112



2005 CT2-D 19L	115	2180	600	3175	609
2005 CT2-D 20	113	2187	229	3219	225
2005 CT2-D 30	113	2190	229	3221	225
2005 CT2-DT 2142	115	2193 U-10	227	3287	224
2005 CT2-INR	115	2193 U-3	227	3290	224
2005 CT2-TX 30	114	2193 Z-94	227	3293 U-10	221
2005 CT3-32	113	2194	229	3293 U-2	221
2005 CT4-2-7	113	2195	229	3293 U-3	221
2005 CT4-2160-119	114	2200 - 2201	551	3293 Z-94	221
2005 CT4-7 XL	113	2250	602	3294	225
2005 CT4-8000	114	2261	605	3294	291
2005 CT4-U-20	112	2268	605	3294	295
2030	174	2270	604	3295	225
2087	173	2300	602	3296	224
2088	174	2303	600	3785	611
2090	173	2310	603	3810	611
2090 A	174	2320	603	4100 - 4301	297
2090 KR	174	2325	601	4150 - 4151	298
2093 HR-94	168	2330	606	4400 - 4485	296
2093 U-10	168	2415	618	4528	595
2093 U-20	168	2423	618	4529	595
2093 U-3	168	2430	24	4533-2	556
2093 U-3 T	168	2456	625	4534	556
2093 Z-94	168	2525-520	21	4549 - 4550	295
2094	174	2630	634	4549 - 4550 - 4551	295
2095	174	2631	633	4589	546
2097	173	2640	634	4610	542
2098	173	2785	620	4611	542
2098 T	173	2786	621	4612	542
2099	174	2787	623	4615	579
2104	523	3019	191	4629	595
2132	229	3020	191	5700	560
2133	347	3081	190	5703	560
2133 T	356	3084	189	7112	322
2142 T (AF)	354	3087	189	7118	325
2142 T (MM)	354	3087 A	189	7212	322
2142 TX	355	3090	190	7218	325
2150	345	3090 A	190	7312	322
2150-2160 PH	348	3090 KR	190	7412	323
2150-2160 PZ-06	349	3090 M	190	7418	326
2153	345	3093 ALU-10	181	7460 Z - 7471 Z	286
2154SK	350	3093 GU-3	182	7480 SE - 7482 SE	287
2160 PH	345	3093 U-10	181	7554 AM A+S - 7572 F A+S	285
2160 PHZ-06	348	3093 U-20	181	7612	323
2160 PZ	346	3093 U-3	181	7618	326
2160SK PH	350	3093 U-3 T	182	7812	323
2160SK PZ	350	3093 Z-94	182	7818	326
2161 PH	346	3094	191	7912	324
2161 PZ	346	3095	191	7918	326
2163 K	346	3096	189	8000 A 0 - A 4	401
2163 KTX	347	3098	189	8000 A 01 - A 41	402
2163 TX	346	3114 / DS 3114	144	8000 A 01G - A 21G	401
2163 TX	349	3165	610	8000 A 02 - A 42	402
2163 TXB	347	3170	609	8000 A 0G - A 2G	401
2163 TXB-05	349	3171	609	8000 A 4 - A 6	402
2163 TXIP	347	3173	609	8000 A 41 - A 61	402



8000 AE	400	8148	392	8352-1	390
8000 AE 0 - AE 4	400	8152 - 8153	393	8352-2	390
8000 AE 01 - AE 41	401	8155	394	8352-3	390
8000 J 0 - J 4	403	8156	394	8353-1	390
8000 J 01 - J 41	403	8157	394	8353-2	391
8000 J 02 - J 42	404	8178	420	8353-3	391
8000 J 4 - J 6	404	8179	420	8354-1	391
8000 J 4 - J 6	404	8200	316	8460 Z - 8471 Z	283
8000 J 41 - J 61	404	8200	371	8367	375
8000 JE 0 - JE 4	403	8210	371	8370	375
8000 JE 01 - JE 41	403	8245	371	8380	375
8005 A	405	8248	370	8381	375
8005 A	405	8250	372	8385	418
8005 J	405	8250-225 TL	372	8386	418
8006	406	8272	541	8480 SE - 8482 SE	284
8006 X-GRIP	406	8276	536	8532	550
8090	381	8301 - 8305	310	8533	550
8092	381	8305-2	387	8551	557
8093	381	8305-6	387	8551	558
8094	381	8305-7	388	8551 S	557
8095	381	8305-9	388	8551 S	557
8096	564	8306-1	384	8551 TG	558
8097	382	8306-10	386	8552-025	557
8098	382	8306-2	384	8553	558
8099	382	8306-4	384	8554 AM - 8559 AML	268
8110	376	8306-5	384	8560 A - 8565 AL	269
8112	376	8306-6	385	8561 B - 8566 BL	270
8120	376	8306-7	385	8562 C - 8567 CL	272
8122	377	8306-8	385	8563 D - 8568 DL	275
8132	377	8306-9	385	8563 DR - 8568 DRL	276
8132 AB	377	8307-3	387	8564 - 8572	281
8133	378	8307-4	387	8564 E - 8569 EL	279
8134	546	8307-7	387	8570 CD - 8575 CDL	273
8135	378	8308-1	386	8571 - 8577	281
8136	379	8308-3	386	8571 DX - 8576 DXL	277
8136 AB	379	8308-4	386	8572 F	280
8137	379	8308-6	388	8573 BC - 8578 BCL	271
8138	379	8313	373	8574 DS - 8579 DSL	274
8139	392	8314	373	8581 EK - 8586 EKL	278
8140	395	8314-180	373	8601	507
8140-01 / -02	396	8315	373	8612	314
8140-03 / -04 / -05	396	8316	374	8701	552
8140-06 / -07 / -08	396	8317	380	8719	552
8140-09 / -10 / -11	396	8318	375	8722	552
8140-12	397	8320 JC	380	8725	552
8140-14	397	8340	419	8726	537
8140-16 / -17	397	8340 / 8340 Z	419	8728	552
8140-18	397	8340 Z	419	8729	552
8140-20	397	8350-2	389	8730	552
8140-21 / -22	397	8350-3	389	8754	319
8140-23	397	8350-5	389	8756	319
8140-24 / -25	397	8350-6	389	8790 - 8793	319
8141	393	8350-7	389	8791 (AF)	317
8142	393	8350-8	389	8791 (MM)	317
8146	392	8350-9	390	8792 (AF)	318
8147	391	8351-1	390	8792 (MM)	318

8794-00	320	DMK	290	E 620 E + E 620 H	508
8794-02 - 8794-03	321	DMKPK	291	E 9 E + E 9 H	512
8794	321	DMSE	293	E-100 / E-175 / E-9100	414
8795	320	DMUK	291	E-1101 BT	62
8796	320	DMZ	292	E-1500 - E-2500	35
8797	318	DS 49	544	E-1580	35
8798	321	DT 2142	355	E-2005 CT	35
8799	321	DT 2143 KTX	355	E-2005 CT	114
8800	309	DTT 42	356	E-2268	605
9100 2K	413	DVI-20L / Z + DVI-28L / Z	339	E-2270	604
9144	416	DVI-20L / Z + DVI-28L / Z	338	E-251 E	548
210015	598	DVV-13Z	340	E-261 E	548
231011	601	DVV-13Z	341	E-3000	35
AGSE9	324	DVV-40Z + DVV-40ZRS	335	E-36	538
B 1525	34	DVV-540RS	337	E-36 Z	538
BR 1500	32	DVV-60ZRS - DVV-130ZRS	336	E-411	554
BR 1500 LH	32	E 120	417	E-4528	595
BR 1504	31	E 122	417	E-4529	595
D 19 (AF)	209	E 126	610	E-8005 A	405
D 19 (MM)	209	E 18 E	514	E-8005 J	405
D 19 (WW)	210	E 20 E + E 20 H	508	E-8006	406
D 19 L (AF)	210	E 210	598	E-8099	382
D 19 L (MM)	210	E 2180	600	E-8099	581
D 19 L-015	198	E 220 - E 222	599	E-8178	420
D 19 WAU-20	201	E 224	518	E-8179	420
D 19 XMAU-20	202	E 224	546	E-8320	380
D 19 YWU-20	202	E 224 E	518	E-8601	507
D 20 (AF)	170	E 225	518	Eck-Schwede-snap®	412
D 20 (MM)	170	E 2250	602	ET-1100 W	62
D 20 DMU-3	160	E 226 E	519	ET2SA	312
D 20 EMU-3	162	E 2261	605	ETP	315
D 20 KAU-20	163	E 2300	602	ETPG	315
D 20 KMU-20	162	E 2303	600	GDMK	290
D 20 L	170	E 2310	603	GDMSE	293
D 20 MOT	164	E 231011	601	GDMZ	292
D 20 MOT-A	165	E 233	607	H 42 DKEL-88	356
D 20 TMU-10	163	E 2340	608	H 42 EL-88	357
D 21 (AF)	228	E 243	619	H 42 EL-88 A	357
D 21 (MM)	228	E 2456	626	H 42 KEL-88	357
D 21 EAU-10	226	E 2457 - E 2458	626	H 42-10	358
D 21 EMU-10	226	E 247	517	H 42-88 A	359
D 30 (AF)	184	E 247 H	517	H 43 KTX-07	362
D 30 (MM)	184	E 248	516	H 43 TX	362
D 30 GAU	180	E 248 H	516	H 6	40
D 30 JAU	180	E 249	628	H 6	135
D 30 KMU-20	178	E 250	629	IKS 19	212
D 30 L (AF)	184	E 276	624	IKS 19 PZD	212
D 30 L (MM)	184	E 2785	620	IKS 20	171
D 30 TX20 U-20	178	E 2786	622	IKS 20 PZD	172
D 32 (AF)	223	E 2787	623	IKS 30	187
D 32 (MM)	222	E 280	635	IKS 30 PZD	187
D 32 EA	220	E 4 E + E 4 H	505	IN 19 (AF)	213
D 32 EMAU-2	220	E 4 K	506	IN 19 (MM)	212
D 48	544	E 5	504	IN 19 K	213
D 55	545	E 600 E + E 600 H	504	IN 19 L	213
DG 30	185	E 609 H	511	IN 19 LK	214



IN 19 LKM	199	K 1900-018	250	R 1504 L	34
IN 19 PA	201	K 20 (AF)	233	R 1504 XL-L	34
IN 19 PM	198	K 20 (MM)	233	R 2004 L	25
IN 19 Q	195	K 21 (AF)	246	RT 1504 L	34
IN 20	172	K 21 (MM)	246	RT 2004 L	25
IN 20 K	172	K 21 L	246	RZB1-18CR	399
IN 20 L	172	K 21 S	245	S 1000	74
IN 21	228	K 21 SL	245	S 1002	83
IN 30 (AF)	187	K 30	234	S 1004	76
IN 30 (MM)	187	K 32 (AF)	242	S 1005 A	89
IN 30 L	188	K 32 (MM)	242	S 1006	84
IN 30 LK	188	K 32 L	242	S 1007	87
IN 30 LKM	179	K 32 S	241	S 1008	86
IN 32	223	K 32 SL	241	S 1016	83
IN 32 L	223	K 32-040	241	S 1019	90
IN 34	145	K 37	248	S 1022	91
IN K 19	239	K 37 L	248	S 1023	85
IN K 21	247	K 64	249	S 1023	589
IN K 32	243	KB 1930	240	S 1024	81
INR 19 L	214	KB 1932	240	S 1025	80
INS 20 PM	160	KB 1970 - KB 1975	240	S 1050	74
INX 19	214	KB 1990	240	S 1090	75
INX 19 L	214	KB 1995	240	S 1093	76
INX 19 PM	199	KB 2070 - KB 2075	233	S 1093	590
INX 30	188	KB 2090	233	S 1150	79
INX 30 L	188	KB 2132	247	S 1151	82
IS 19	212	KB 2137	247	S 1151 A	88
IS 20	171	KB 2170 - KB 2175	247	S 1400 G	77
IS 30	186	KB 2190	247	S 1400 Z	78
ITX 19	211	KB 2195	247	S 141-3	531
ITX 19 B	211	KB 3019	235	S 1500 ES-01	92
ITX 19 INU-20	197	KB 3020	235	S 1500 ES-02	93
ITX 19 L	211	KB 3070 - KB 3075	235	S 1500 ES-03	94
ITX 19 LKP	200	KB 3090	235	S 2032-05	175
ITX 19 PM / ITX 19 B-PM	199	KB 3095	235	S 42-07	360
ITX 19 TX-017	200	KB 3219	243	S 42-09 A	360
ITX 19 TXU-20	196	KB 3221	243	S 51 GU	545
ITX 20	171	KB 3270 - KB 3275	243	S 8000	424
ITX 20 K	171	KB 3290	243	S 8003 JC	421
ITX 20 PM	161	KB 3295	243	S 8003 TL	421
ITX 20 TX-015	161	KB 3721	248	S 8006	406
ITX 30	186	KB 3764	249	S 8008	424
ITX 30 B	186	KB 3770 - KB 3775	249	S 8024	424
ITX 30 L	186	KB 619 - KB 630	255	S 8028	425
ITX 30 LKP	179	KB 6437	249	S 8100	424
ITX 30 PM	179	KB 6470 - KB 6475	249	S 8140 A	398
ITX 30 TX-015	179	KB 819 - KB 830	257	S 8140 D	398
ITX 32	223	KD 26 R	149	S 8140 E	398
ITX K 19	238	KD 626	148	S 8140 J	398
K 19 (AF)	237	KR 19	238	S 8140 PN	399
K 19 (MM)	236	PGNE FS	301	S 8200 JC	422
K 19 L	237	PGNP FS	300	S 8303 JC	422
K 19 LS	238	PGNS FS	300	S 8303 TL	422
K 19 LS-004	236	PH 42-88	358	S 8305 ESD	383
K 19-028	236	PR 265	545	SCL 42 K-70	361
K 1900	250	R 1500 L	36	SCL 42-70	361

SCL 42-90 A	361	VDE 4507	573	WT 1056 5	566
SCL 43 TX-80	361	VDE 4522	594	WT 1056 6	566
SK 2154 PH-06	350	VDE 4522 K	594	WT 1056 7	566
SL 19	218	VDE 4527	594	WT 1056 8	566
SL 2013	175	VDE 4527 K	594	WT 1056 9	566
SL 3014	191	VDE 8094	580		
SUKSE	324	VDE 8098	580		
TT3KH	313	VDE 8098 H	580		
TX 19	210	VDE 8099	581		
TX 19 E-09	199	VDE 8099 H	581		
TX 20	170	VDE 8120	585		
TX 30	185	VDE 8120 H	585		
TX 30 E-08	179	VDE 8122	585		
TX 4	132	VDE 8122 H	585		
TX K 19	239	VDE 8131 AB	581		
TX K 30	234	VDE 8132	586		
V 180	579	VDE 8132 AB	586		
V 2160 MS PH	576	VDE 8132 AB H	586		
V 406	595	VDE 8132 H	586		
V 42	575	VDE 8250	582		
V 42 T	575	VDE 8250 H	582		
V 4616	579	VDE 8314	582		
V 60 CP	572	(VDE) 8314-180	583		
V 8091	580	VDE 8314 H	583		
V 911	593	VDE 8314-180 H	583		
V 912	593	VDE 8315 H	584		
V 914	594	VDE 8316	584		
V 915	593	VDE 8316 H	584		
V 917	594	VDE 8367	584		
VDE 1001	592	VDE 894	572		
VDE 146	581	VDE 910	593		
VDE 19	574	VDE 913	593		
VDE 1988 - VDE 1989 T	574	VDE IN 19	574		
VDE 1990	574	VDE INX 30	573		
VDE 1991	574	VDE S 8003	587		
VDE 1993 U	575	VDE S 8003 H	587		
VDE 2 E	572	VH 19	218		
VDE 2133	572	VH 30	191		
VDE 2160 PH	576	VS 1582	39		
VDE 2160 PZ	576	VS 19 H	39		
VDE 2162 PH	577	VS 245 H	39		
VDE 2162 PZ	577	WK 1000 L	51		
VDE 2162-2172 PH-02	577	WK 1015 L	51		
VDE 2162-2172 PM-06	577	WK 1018 L	51		
VDE 2162-2172 PZ-06	578	WK 1091 L	51		
VDE 2163 K	578	WSL-L	20		
VDE 2163 TX	578	WT 1056 1	565		
VDE 2164	578	WT 1056 10	567		
VDE 2170	575	WT 1056 11	567		
VDE 2170-2160 PH-077	579	WT 1056 12	567		
VDE 2172	576	WT 1056 13	567		
VDE 30	573	WT 1056 2	565		
VDE 3090	573	WT 1056 3	565		
VDE 3093 U	573	WT 1056 4	565		



# DISCLAIMER

This catalogue replaces all previous editions.  
The photographs and technical details are of the articles offered at present.

Since we are constantly updating and improving our products to keep them at the present state of the art, we reserve the right to make modifications and changes with regard to appearance, dimensions (always in "mm", if not otherwise stated), weights and properties, as well as in performance. No claim for correction or replacement supplies may thus be made with regard to products already delivered. Cancellations may be made at any time without there being any grounds for legal claim.

All information on use or safety is non-binding; nor does it replace any legal regulations or those made by professional or trade associations.

We do not accept any liability for printing errors. No supplemental items (tools etc.) are included in the scope of supply.

Reprinting, even of excerpts, requires the previous permission in writing by GEDORE.  
All rights reserved worldwide.

We refer to our current general agreements and commercial conditions as well as our delivery and payment conditions in the imprint under [www.gedore.com](http://www.gedore.com).

**Overall concept, design and layout:**

GEDORE Werkzeugfabrik GmbH & Co. KG  
Remscheider Straße 149  
42899 Remscheid · GERMANY

T +49 2191 596-0  
F +49 2191 596-230  
[info@gedore.com](mailto:info@gedore.com)  
[www.gedore.com](http://www.gedore.com)

**Brands of the GEDORE Group**

[gedore.com](http://gedore.com) · [ochsenkopf.com](http://ochsenkopf.com)

© Copyright by GEDORE Remscheid



## DE IMPRESSUM

Dieser Katalog ersetzt alle vorherigen Ausgaben. Fotos und technische Angaben entsprechen dem augenblicklichen Stand. Im Zuge der Verbesserung und Anpassung an den Stand der Technik behalten wir uns Änderungen im Hinblick auf Aussehen, Abmessungen (immer in „mm“, sofern keine andere Angabe), Gewichte und Eigenschaften sowie Leistungen vor. Damit ist kein Anspruch auf Korrektur oder Nachlieferung bereits gelieferter Produkte verbunden. Streichungen können jederzeit vorgenommen werden, ohne dass ein rechtlicher Anspruch entsteht. Alle Hinweise zur Benutzung und Sicherheit sind unverbindlich. Sie ersetzen keinesfalls irgendwelche gesetzlichen oder berufsgenossenschaftlichen Vorschriften. Für Druckfehler übernehmen wir keine Haftung. Im Lieferumfang ist keine Dekoration (Werkzeuge, etc.) enthalten. Ein Nachdruck, auch auszugsweise, bedarf der vorherigen schriftlichen Zustimmung durch GEDORE. Alle Rechte weltweit vorbehalten. Wir verweisen auf unsere aktuellen Rahmen- und Konditionsvereinbarungen sowie auf unsere Liefer- und Zahlungsbedingungen unter [www.gedore.com](http://www.gedore.com).

## EN DISCLAIMER

This catalogue replaces all previous editions. The photographs and technical details are of the articles offered at present. Since we are constantly updating and improving our products to keep them at the present state of the art, we reserve the right to make modifications and changes with regard to appearance, dimensions (always in “mm”, if not otherwise stated), weights and properties, as well as in performance. No claim for correction or replacement supplies may thus be made with regard to products already delivered. Cancellations may be made at any time without there being any grounds for legal claim. All information on use or safety is non-binding; nor does it replace any legal regulations or those made by professional or trade associations. We do not accept any liability for printing errors. No supplemental items (tools etc.) are included in the scope of supply. Reprinting, even of excerpts, requires the previous permission in writing by GEDORE. All rights reserved worldwide. We refer to our current general agreements and commercial conditions as well as our delivery and payment conditions in the imprint under [www.gedore.com](http://www.gedore.com).

## NL COLOFON

Deze catalogus vervangt alle voorafgaande uitgaven. Foto's en technische informatie zijn conform de huidige stand van zaken. Veranderingen en/of verbeteringen ten aanzien van uiterlijk, afmetingen (altijd in mm, tenzij anders aangegeven), gewicht, eigenschappen en prestaties, bijvoorbeeld als gevolg van technische ontwikkelingen, behouden wij ons uitdrukkelijk voor. Wijzigingen verplichten ons niet tot aanpassing of herlevering van reeds geleverde artikelen. Artikelen kunnen bovendien op ieder moment, zonder verdere verplichtingen onzerzijds, uit de productie worden genomen. Alle aanwijzingen ten aanzien van gebruik en veiligheid zijn vrijblijvend en vervangen nimmer eventuele wettelijke veiligheidsmaatregelen of gebruiksvorschriften. Voor drukfouten zijn wij niet aansprakelijk. In de leveringsomvang is geen decoratie-materiaal (gereedschap etc.) inbegrepen. Nadruk van, of overname van gedeelten uit, deze catalogus is alleen toegestaan na voorafgaande schriftelijke toestemming van GEDORE. Alle rechten wereldwijd voorbehouden. Levering geschiedt via de vakhandel.

## FR MENTIONS LÉGALES

La présente édition du catalogue remplace toutes les précédentes. Photos et caractéristiques techniques correspondent à la situation actuelle. En raison des améliorations et de l'adaptation à l'évolution des techniques, nous vous réservons le droit de procéder à des modifications quant à l'apparence, aux dimensions (toujours en « mm » sauf en cas d'indication contraire), aux poids, caractéristiques et aux performances. Aucune réclamation concernant des modifications ou des livraisons différées de produits précédemment livrés n'est recevable. Des suppressions peuvent être effectuées à tout moment sans qu'elles puissent donner lieu à réclamation. Toutes les instructions d'utilisation et conseils de sécurité sont sans engagement. Ils ne se substituent en aucun cas aux prescriptions légales ou à celles émises par les associations professionnelles. Des suppressions peuvent être effectuées à tout moment sans qu'elles puissent donner lieu à réclamation. Une reproduction, même partielle, ne peut être effectuée qu'après accord préalable et donné par écrit par GEDORE. Tous droits dans le monde entier réservés. Vous trouverez la version actuelle de nos conditions commerciales générales ainsi que nos conditions de livraison et de paiement dans l'impressum à l'adresse : [www.gedore.com](http://www.gedore.com)

## IT IMPRESSIONI

Questo catalogo sostituisce tutte le precedenti edizioni. Foto e dati tecnici corrispondono alle attuali esecuzioni. Ci riserviamo eventuali modifiche tecniche di miglioramento degli utensili o di modifica della forma, misura, peso e caratteristiche in generale, senza alcun preavviso. Ciò vale anche per l'eliminazione di articoli. Tutte le descrizioni sull'utilizzo e la sicurezza degli utensili sono indicative e non sostituiscono in nessun caso locali prescrizioni di legge. Non assumiamo responsabilità per eventuali errori di stampa. Una ristampa anche parziale del catalogo necessita della nostra approvazione scritta. Ci riserviamo tutti i diritti a livello mondiale. Valgono le nostre condizioni di vendita riportate nel nostro sito [www.gedore.com](http://www.gedore.com).

## PL PODSUMOWANIE

Ten katalog zastępuje wszystkie wcześniejsze wydania. Zdjęcia i dane techniczne odpowiadają stanowi w chwili opracowania. Ze względu na zmiany i ulepszenia wynikające z postępu techniki, zastrzegamy sobie prawo do zmian wyglądu zewnętrznego, wymiarów, wag oraz właściwości i wytrzymałości

prezentowanych produktów. Nie może być to podstawą roszczeń do korekty, zmiany lub uzupełnienia wysłanych produktów. Zastrzeżone są wszelkie wykreślenia z programu i nie dają one prawa do roszczeń. Wszelkie wskazówki w zakresie użytkowania i bezpieczeństwa są niewiążące. Nie zastępują one, w żadnym przypadku, jakichkolwiek przepisów prawa lub wymogów organizacji zawodowych. Nie przyjmujemy żadnej odpowiedzialności za błędy drukarskie. Dostawa nie obejmuje dekoracji pokazanych na zdjęciach (narzędzi itp.). Przedruki, także skrócone, wymagają zawsze wcześniejszej, pisemnej zgody GEDORE. Wszelkie prawa zastrzeżone na całym świecie. W sprawie naszych aktualnych zasadach, porozumień, warunków dostaw i płatności prosimy o kontakt przez [www.gedore.com](http://www.gedore.com).

## CZ IMPRESUM

Tento katalog nahrazuje všechna předcházející vydání. Fotografie a technické údaje odpovídají aktuálnímu stavu. Protože však neustále zdokonalujeme a modernizujeme naše výrobky, aby odpovídaly současnému stavu technologií, vyhrajujeme si právo provést změny a modifikace vzhledu, rozměrů (vždy v mm, pokud není uvedeno jinak), hmotnosti, vlastností a parametrů. Nelze tedy požadovat opravu nebo výměnu výrobků, které už byly dodány. Omezení lze provést kdykoliv bez jakéhokoliv základu na právní nároky. Všechny pokyny k používání nebo bezpečnostní pokyny jsou pouze informativní, nenahrazují jakékoli právní předpisy nebo směrnice vydané profesními nebo odborovými organizacemi. Nepřebíráme jakoukoliv odpovědnost za tiskové chyby. Součástí dodávky nejsou žádné dekorativní předměty (nástroje apod.). Pro přetisk, a to i výtahů, je vždy nutné si předem vyžádat písemný souhlas společnosti GEDORE. Veškerá práva vyhrazena, celosvětově. Odkazujeme se na naše všeobecné rámcové a obchodní podmínky i na naše dodací a platební podmínky uvedené na adrese [www.gedore.com](http://www.gedore.com).

## ES PIE DE IMPRINTA

Reemplaza todas las ediciones anteriores (listas de precios y catálogos). Las fotos y los datos técnicos reflejan el estado actual. Para mejorar e ir adaptándonos al estado de la técnica, nos reservamos el derecho de realizar modificaciones en cuanto al aspecto, las dimensiones y características, así como en cuanto al rendimiento. Ello no supone ningún derecho de corrección o suministro adicional de los productos ya suministrados. Podemos realizar cancelaciones en todo momento, sin que esto suponga ningún derecho a reclamación. No nos responsabilizamos de las posibles erratas. En el suministro no se incluyen los artículos decorativos (herramientas, etc). La reimpresión, total o parcial, deberá obtener la autorización escrita previa de GEDORE. Reservados todos los derechos en todo el mundo. Les remitimos a nuestros contratos marco y de condiciones, así como a nuestras condiciones de suministro y pago del pie de imprenta que encontrará en [www.gedore.com](http://www.gedore.com)

## EL ΑΠΟΠΟΙΗΣΗ

Αντικαθιστά όλες τις προηγούμενες εκδόσεις. Οι φωτογραφίες και τα τεχνικά στοιχεία αντιστοιχούν στην τρέχουσα έκδοση. Στα πλαίσια της βελτίωσης και της προσαρμογής στην εξέλιξη της τεχνολογίας επιφύλασσώμεθα για αλλαγές ως προς την εμφάνιση, τις διαστάσεις και τις ιδιότητες καθώς και τις επιδόσεις. Λόγω των παραπάνω δεν απορρέουν αξιώσεις για διόρθωση ή εκ των υστέρων παράδοση προϊόντων που έχουν ήδη παραδοθεί. Ανά πάσα στιγμή μπορούν να πραγματοποιηθούν διαγραφές, χωρίς να προκύπτουν νομικές αξιώσεις. Η ανατύπωση, ακόμη και αποσπασματική, χρειάζεται την προηγούμενη έγγραφη έγκριση της GEDORE. Με επιφύλαξη κάθε νόμιμου δικαιώματος παγκοσμίως. Σας παραπέμπουμε στους τρέχοντες Γενικούς Όρους Συνεργαζών και Συμβάσεων, καθώς και στους όρους παράδοσης και πληρωμής στο Impressum στο [www.gedore.com](http://www.gedore.com)

## PT INFORMAÇÃO

Substitui todas as edições anteriores. As fotografias e características técnicas correspondem aos artigos fornecidos actualmente. Produtos sujeitos a alterações (aspecto, dimensões, propriedades, potências, etc.) no âmbito do aperfeiçoamento técnico, sem direito a compensação ou devolução dos artigos fornecidos. Produção sujeita a cancelamento sem aviso prévio. Não nos responsabilizamos por erros de impressão. O equipamento standard não inclui elementos decorativos (ferramentas, etc.). A reprodução da totalidade ou parte do presente documento está sujeita a autorização prévia e por escrito da GEDORE. Direitos reservados para todo o mundo. Consulte o site [www.gedore.com](http://www.gedore.com) para informação sobre acordos gerais e de comercialização, bem como para condições de fornecimento.

**Gesamtkonzeption, grafische Realisation und Gestaltung: / Overall concept, design and layout: / Concezione globale, réalisation graphique et agencement: / Concezione generale, realizzazione grafica e configurazione: / Całkowita koncepcja, realizacja graficzna oraz konfiguracja: / Celková koncepcie, grafický návrh a realizace/ Concepción general, maquetación y diseño: / Γενική αντίληψη, σχεδιασμός και διαρρύθμιση: / Conceção geral, realização e concepção gráfica:**

GEDORE Werkzeugfabrik GmbH & Co. KG  
Remscheider Straße 149  
42899 Remscheid · GERMANY

T +49 2191 596-0  
F +49 2191 596-230

[info@gedore.com](mailto:info@gedore.com)  
[www.gedore.com](http://www.gedore.com)

**Brands of the GEDORE Group**  
[gedore.com](http://gedore.com) · [ochsenkopf.com](http://ochsenkopf.com)

© Copyright by GEDORE



**Brands of the GEDORE Group**  
gedore.com · ochsenkopf.com

# 2019

**GEDORE Werkzeugfabrik GmbH & Co. KG**  
Remscheid-er Straße 149  
42899 Remscheid · GERMANY  
Tel. + 49 (0) 21 91- 596 - 0  
Fax + 49 (0) 21 91- 596 - 230  
info@gedore.com  
www.gedore.com

Vertrieb Deutschland  
Tel. + 49 (0) 21 91- 596 - 900  
Fax + 49 (0) 21 91- 596 - 999  
Sales International  
Tel. + 49 (0) 21 91- 596 - 910  
Fax + 49 (0) 21 91- 596 - 911

**GEDORE Automotive GmbH**  
Breslauer Straße 41  
78166 Donaueschingen · GERMANY  
Tel. +49 711 83223-0  
Fax +49 711 83223-90

**GEDORE Torque Solutions GmbH**  
Bertha-Benz-Straße 12  
71665 Vaihingen/Enz · GERMANY  
T +49 7042 9441-0  
F +49 7042 9441-41  
info@loesomat.de

**GEDORE AUSTRIA GmbH**  
Gedore-Str. 1  
8190 Birkfeld / Stmk. · AUSTRIA  
Tel. +43 (0) 3174 / 363 64 00  
Fax +43 (0) 3174 / 363 83 20  
sales.austria@gedore.com  
www.gedore.at

**GEDORE IBÉRICA S.L.**  
c/Arangutxi 12, Polígono Industrial de Júndiz  
01015 Vitoria Alava · SPAIN  
Tel. +34-945-29 22 62  
Fax +34-945-29 21 99  
gedore@gedore.es  
www.gedore.es

**GEDORE UK Limited**  
Marton Street , SKIPTON BD23 1TF  
North Yorkshire · UNITED KINGDOM  
Tel. +44 (0) 1756 / 70 67 00  
Fax +44 (0) 1756 / 79 80 83  
sales@gedoreuk.com  
www.gedoreuk.com

**GEDORE France SARL**  
Parc d'activités des Béthunes - La Mare II  
10, avenue du Fief - Bât. 12  
BP 79144 Saint-Ouen-l'Aumône  
F-95074 Cergy Pontoise Cedex · FRANCE  
Tél. +33 (0)1 34 40 16 60  
Fax +33 (0)1 34 40 16 61  
jadore@gedore.fr  
www.gedore.fr

**GEDORE TECHNAG B.V.**  
Flemingweg 7, 2408 AV  
Alphen aan den Rijn · NETHERLANDS  
Tel. +31 (0) 172 / 42 73 50  
Fax +31 (0) 172 / 42 73 60  
technag@gedore.nl  
www.gedore.nl

**GEDORE POLSKA Sp. z o.o.**  
ul. Żwirki i Wigury 56a  
43-190 Mikołów · POLAND  
Tel. +48 (0) 32 / 738-40 10  
Fax +48 (0) 32 / 738-40 20  
gedore@gedore.pl  
www.gedore.pl

**Ferramentas GEDORE do Brasil S.A.**  
Rua Vicentina Maria Fidélis, 275 Bairro  
Vicentina | Vicentina  
São Leopoldo - RS | 93025-340 · BRAZIL  
Tel. +55 51-35 89 9200  
Fax + 55 51-35 89 9222  
export@gedore.com.br  
www.gedore.com.br

**GEDORE TOOLS, INC.**  
4055 Faber Pl Dr  
North Charleston,  
SC, 29405 · USA  
Tel. +1-843/225 50 15  
Fax +1-843/225 50 20  
info@gedoretools.com  
www.gedoretools.com

**GEDORE Tool Trading (Shanghai) Co., Ltd.**  
1/F., Block 2, 1358 Pingan Road,  
Minhang, Shanghai · CHINA 201109  
Tel. +86-21-3388 7258  
Fax +86-21-3388 7259  
Service Hotline: 400 880 1858  
info@gedore.cn  
www.gedore.cn

**GEDORE Tools S.A. (Pty) Ltd.**  
103 Qashana Khuzwayo (Shepstone) Road,  
New Germany, 3610 - South Africa  
PO Box 68, New Germany, 3620  
SOUTH AFRICA  
Tel. +27 (0) 31 / 705 3587  
Fax +27 (0) 31 / 705 32770  
general@gedoresa.co.za  
www.gedore.co.za

**GEDORE (INDIA) Private Limited**  
148, Sector 3, IMT Manesar  
Gurgaon – 122051  
Haryana · INDIA  
Tel. +91 (0) 124 22910 – 65/66/67  
Fax +91 124 2341067  
sales@gedoreindia.com  
www.gedore.in

**GEDORE Tools Middle East FZE**  
P.O Box 372042  
West Wing 5B, Office #440  
Dubai Airport Free Zone  
Dubai · U.A.E  
Tel. +971 4 236 4606  
info@gedore.ae

**GEDORE Tool Center 000**  
4.-ya Magistralnaja H11/1  
123007 Moscow · RUSSIA  
Tel. 8 800 100 58 96 (free from Russia)  
Tel. +7 (499) 754 7000  
Fax +7 (8) 985 22 99 88 0  
sales@gedoretools.ru